

# DATA SHEET

**RC01/11/21/31**

**5%**

General purpose chip resistors  
sizes 1206, 0805, 0603 and 0402

Product specification  
Supersedes data of 26th February 2001

2002 Apr 09 Rev.9

# General purpose chip resistors

## sizes 1206, 0805, 0603 and 0402

# RC01/11/21/31

## 5%

### FEATURES

- Low assembly costs
- High component and equipment reliability
- Excellent performance at high frequency, especially the RC31
- Complete standard SMD family.

### APPLICATIONS

- All general purpose applications.

### DESCRIPTION

The resistors are constructed on a high grade ceramic body (aluminium oxide). Internal metal electrodes are added at each end and connected by a resistive paste which is applied to the top surface of the substrate. The composition of the paste is adjusted to give the approximate resistance required and the value is trimmed to within tolerance, by laser cutting of this resistive layer.

The resistive layer is covered with a protective coat and printed with the resistance value. Finally, the two external end terminations are added. For ease of soldering the outer layer of these end terminations is a lead/tin alloy.

### QUICK REFERENCE DATA

| DESCRIPTION  | VALUE  |                      |                     |                     |
|--|--|----------------------|---------------------|---------------------|
|  | RC01   | RC11                 | RC21                | RC31                |
| Size code  | 1206 (3216)  | 0805 (2012)          | 0603 (1608)         | 0402 (1005)         |
| Resistance range   | 1 $\Omega$ to 10 M $\Omega$  |                      |                     |                     |
| Resistance tolerance and E-series  | $\pm 5\%$ ; jumper; E24 series   |                      |                     |                     |
| Temperature coefficient:<br>1 $\Omega \leq R < 10 \Omega$<br>10 $\Omega < R \leq 10 \text{ M}\Omega$ | $\leq 250 \pm 250 \times 10^{-6}/\text{K}$<br>$\leq \pm 200 \times 10^{-6}/\text{K}$ |                      |                     |                     |
| Maximum dissipation at $T_{\text{amb}} = 70 \text{ }^\circ\text{C}$                                  | 0.25 W   | 0.125 W              | 0.1 W               | 0.063 W             |
| Maximum permissible voltage  | 200 V<br>(DC or RMS)   | 150 V<br>(DC or RMS) | 50 V<br>(DC or RMS) | 50 V<br>(DC or RMS) |
| Climatic category (IEC 60068)  | 55/155/56  |                      |                     | 55/125/56           |
| Basic specification  | IEC 60115-8  |                      |                     |                     |

# General purpose chip resistors

## sizes 1206, 0805, 0603 and 0402

# RC01/11/21/31

## 5%

### ORDERING INFORMATION

**Table 1** Ordering code indicating resistor type and packing

| TYPE                | TOL.<br>(%) | ORDERING CODE 2322 ... ..         |                |                |                |                |                |
|---------------------|-------------|-----------------------------------|----------------|----------------|----------------|----------------|----------------|
|                     |             | PAPER TAPE ON REEL <sup>(1)</sup> |                |                |                | BULK CASE      |                |
|                     |             | 5000<br>units                     | 10000<br>units | 20000<br>units | 50000<br>units | 10000<br>units | 25000<br>units |
| RC01                | ±5          | 711 61...                         | 711 51...      | 711 81...      | –              | –              | –              |
| RC11                | ±5          | 730 61...                         | 730 71...      | 730 81...      | –              | 731 81...      | –              |
| RC21                | ±5          | 702 60...                         | 702 70...      | 702 81...      | –              | –              | 702 80...      |
| RC31                | ±5          | –                                 | 705 70...      | –              | 705 87...      | –              | –              |
| <b>Jumper 0 Ω</b>   |             |                                   |                |                |                |                |                |
| RC01 <sup>(1)</sup> | –           | 711 91032                         | 711 91005      | 711 92004      | –              | –              | –              |
| RC11 <sup>(1)</sup> | –           | 730 91002                         | 730 91003      | 730 92002      | –              | 731 91006      | –              |
| RC21 <sup>(2)</sup> | –           | 702 96001                         | 702 97001      | 702 92002      | –              | –              | 702 91002      |
| RC31 <sup>(2)</sup> | –           | –                                 | 705 91001      | –              | 705 91007      | –              | –              |

### Notes

- The jumper has a maximum resistance  $R_{\max} = 50 \text{ m}\Omega$  and a rated current  $I_R = 2 \text{ A}$ .
- The jumper has a maximum resistance  $R_{\max} = 50 \text{ m}\Omega$  and a rated current  $I_R = 1 \text{ A}$ .

### Ordering code (12NC)

- The resistors have a 12-digit ordering code starting with 2322
- The subsequent 5 digits indicate the resistor type and packing; see Table 1.
- The remaining 3 digits indicate the resistance value:
  - The first 2 digits indicate the resistance value.
  - The last digit indicates the resistance decade in accordance with Table 2.

**Table 2** Last digit of 12NC

| RESISTANCE<br>DECADE | LAST DIGIT |
|----------------------|------------|
| 1 to 9.1 Ω           | 8          |
| 10 to 91.0 Ω         | 9          |
| 100 to 910 Ω         | 1          |
| 1 to 9.1 kΩ          | 2          |
| 10 to 91.0 kΩ        | 3          |
| 100 to 910 kΩ        | 4          |
| 1 to 9.1 MΩ          | 5          |
| 10 MΩ                | 6          |

### ORDERING EXAMPLE

The ordering code of a RC11 resistor, value 4700 Ω with ±5% tolerance, supplied on paper tape of 5000 units per reel is: 2322 730 61472.

# General purpose chip resistors

## sizes 1206, 0805, 0603 and 0402

RC01/11/21/31  
5%

### FUNCTIONAL DESCRIPTION

#### Product characterization

Standard values of nominal resistance are taken from the E24 series for resistors with a tolerance of  $\pm 5\%$ . The values of the E24 series are in accordance with "IEC publication 60063".

#### Limiting values

| TYPE | LIMITING VOLTAGE <sup>(1)</sup> (V) | LIMITING POWER (W) |
|------|-------------------------------------|--------------------|
| RC01 | 200                                 | 0.25               |
| RC11 | 150                                 | 0.125              |
| RC21 | 50                                  | 0.063/0.1          |
| RC31 | 50                                  | 0.063              |

#### Note

- This is the maximum voltage that may be continuously applied to the resistor element, see "IEC publication 60115-8".

### DERATING

The power that the resistor can dissipate depends on the operating temperature; see Fig.1.

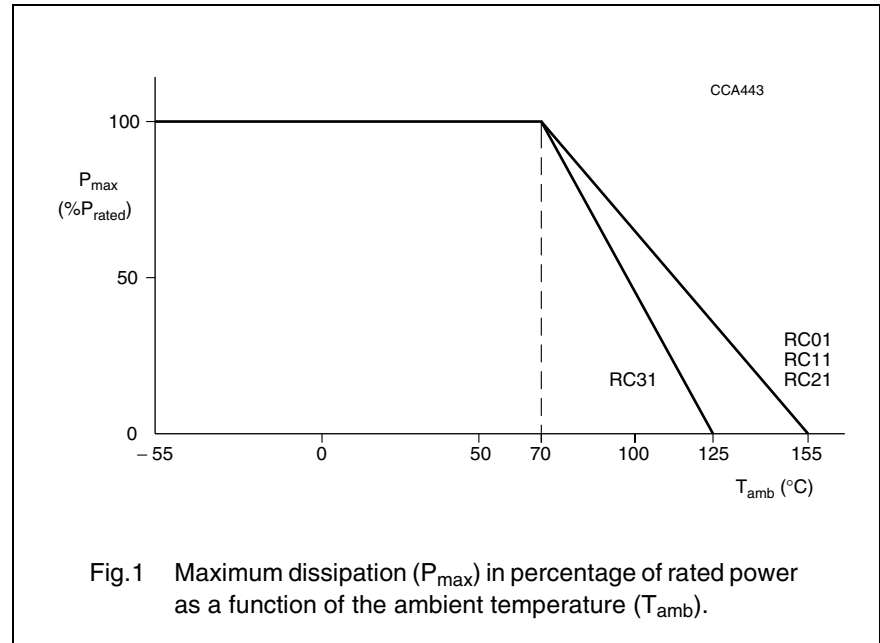
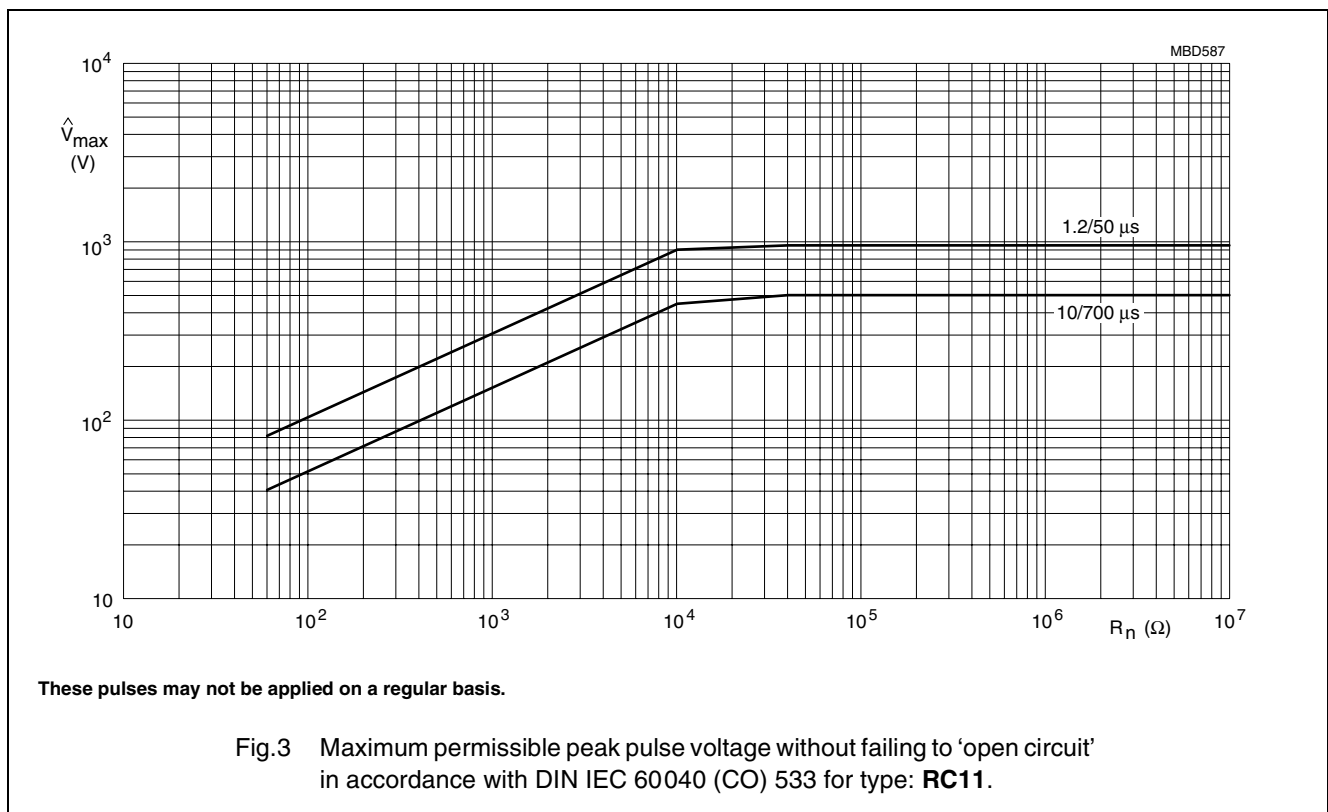
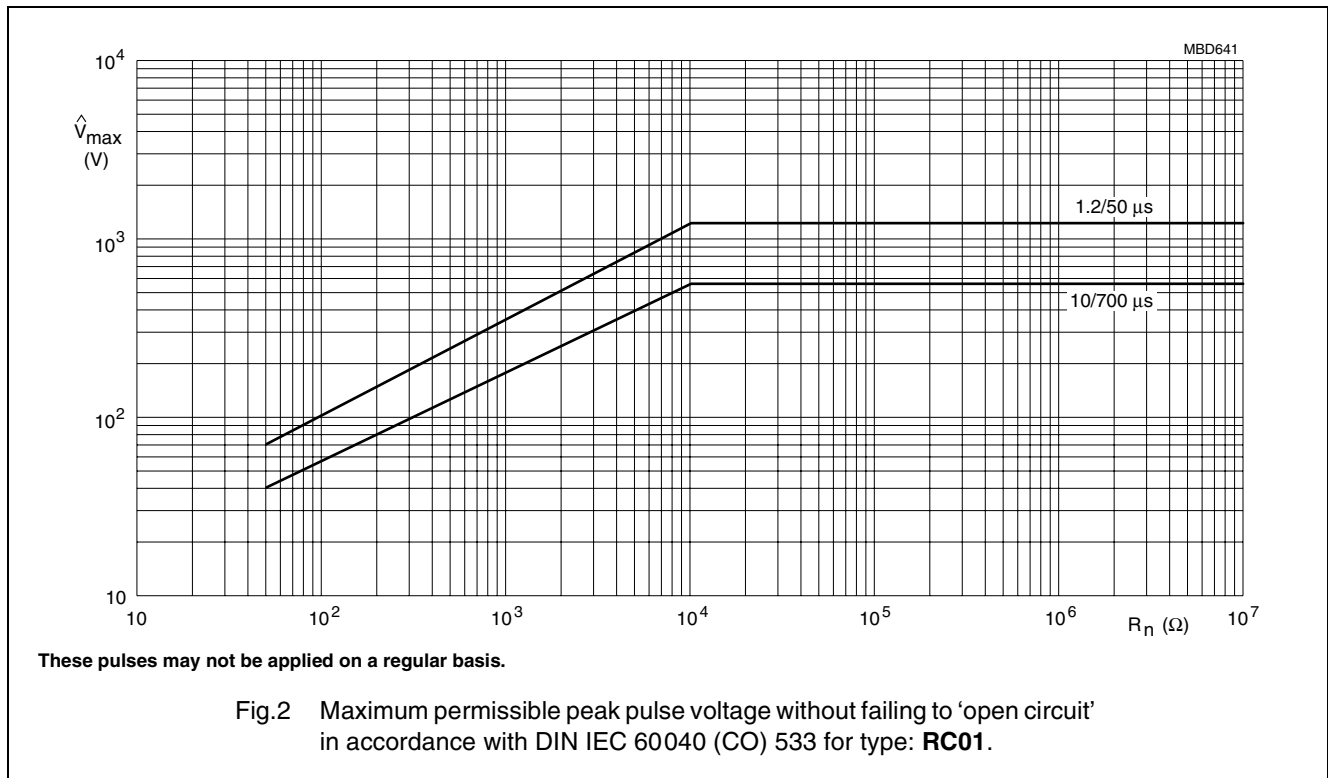

Fig.1 Maximum dissipation ( $P_{max}$ ) in percentage of rated power as a function of the ambient temperature ( $T_{amb}$ ).

General purpose chip resistors  
sizes 1206, 0805, 0603 and 0402

RC01/11/21/31  
5%

## PULSE LOADING CAPABILITIES



General purpose chip resistors  
sizes 1206, 0805, 0603 and 0402

RC01/11/21/31  
5%

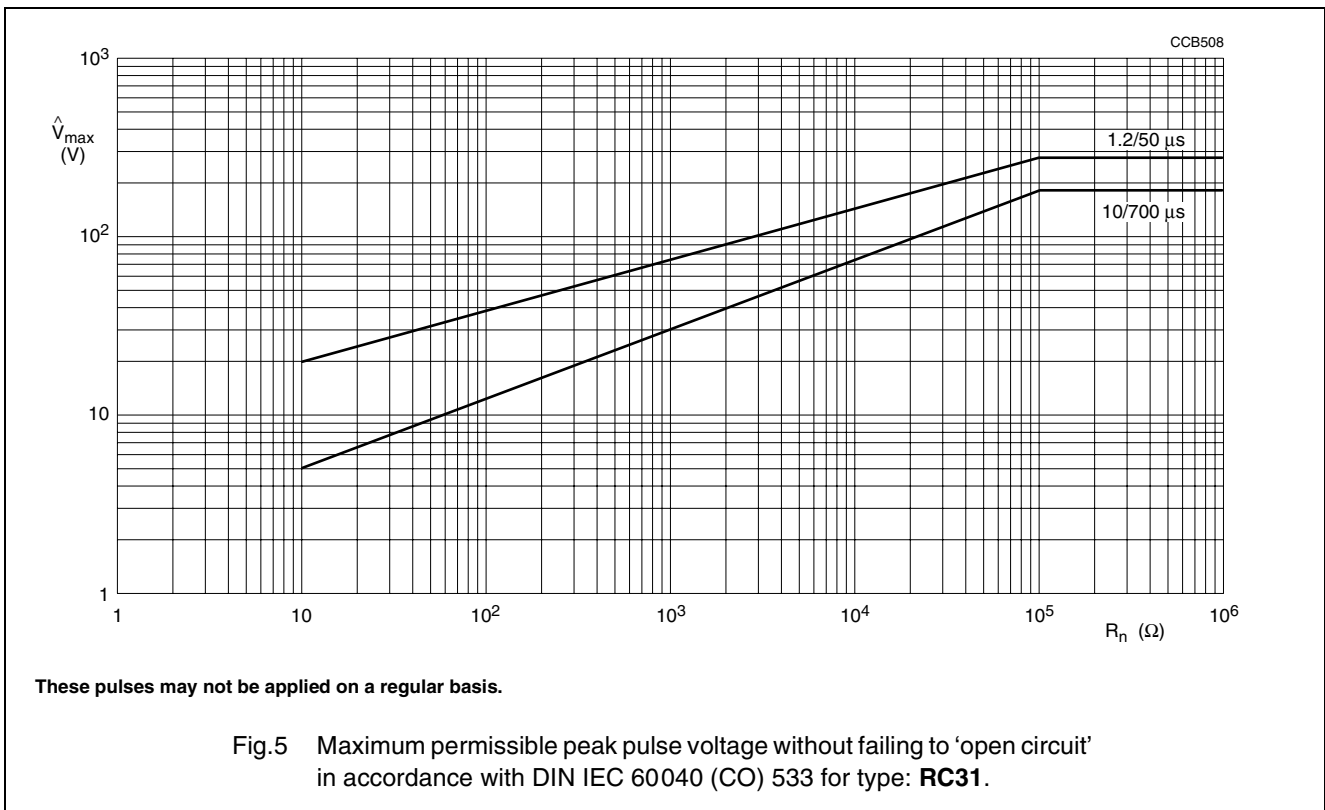
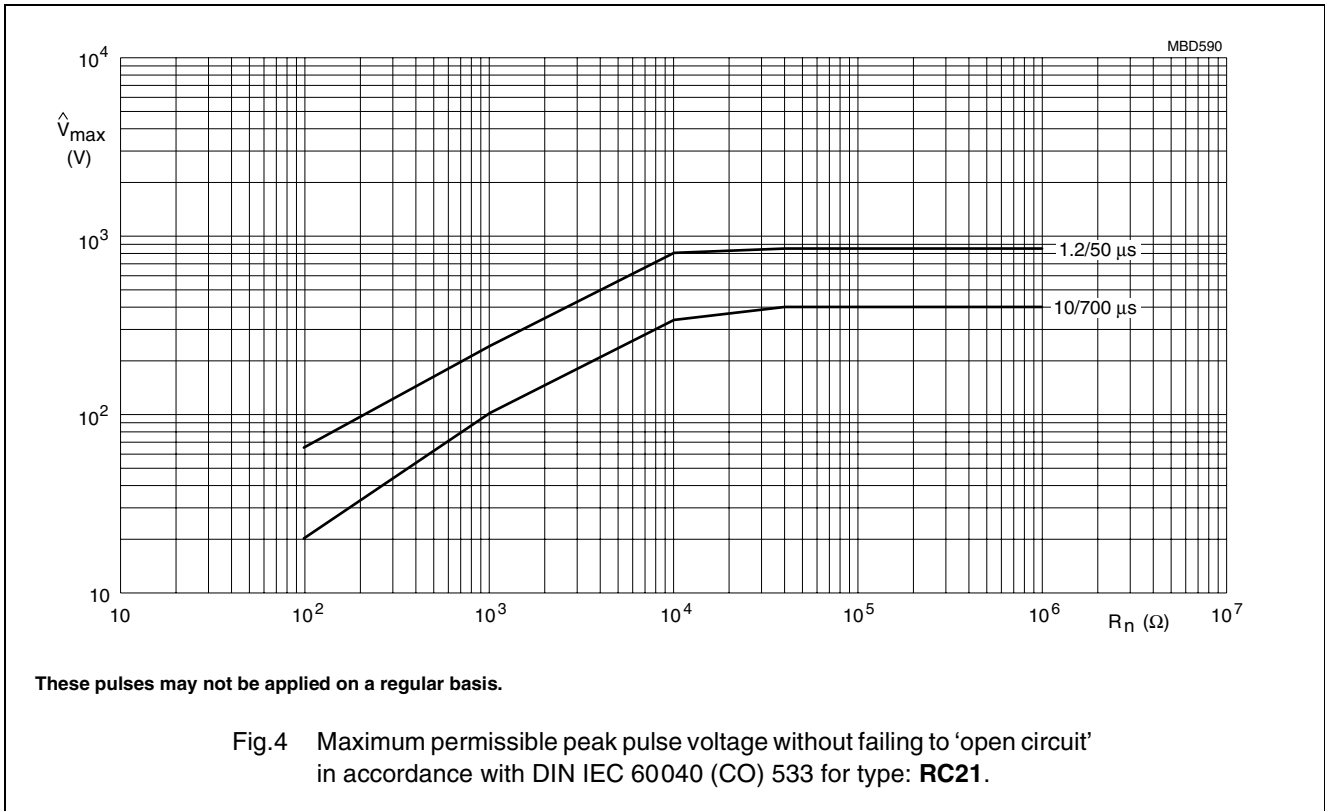

General purpose chip resistors  
sizes 1206, 0805, 0603 and 0402

RC01/11/21/31  
5%

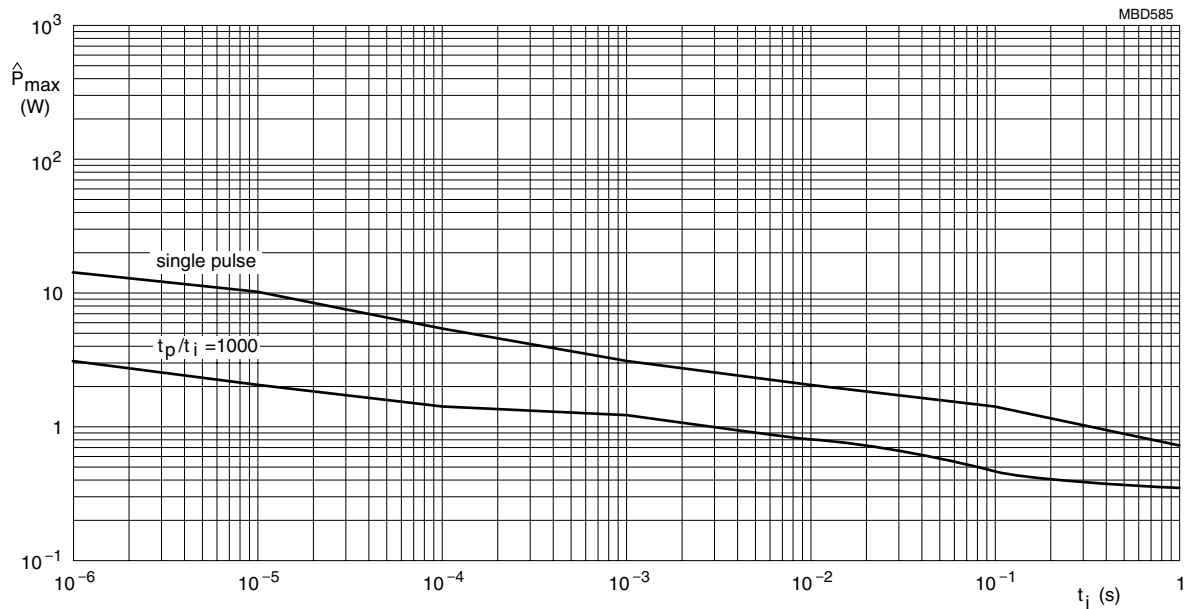

Fig.6 Pulse on a regular basis for type: **RC01**; maximum permissible peak pulse power ( $\hat{P}_{max}$ ) as a function of pulse duration for single pulse and repetitive pulse  $t_p/t_i = 1000$ .

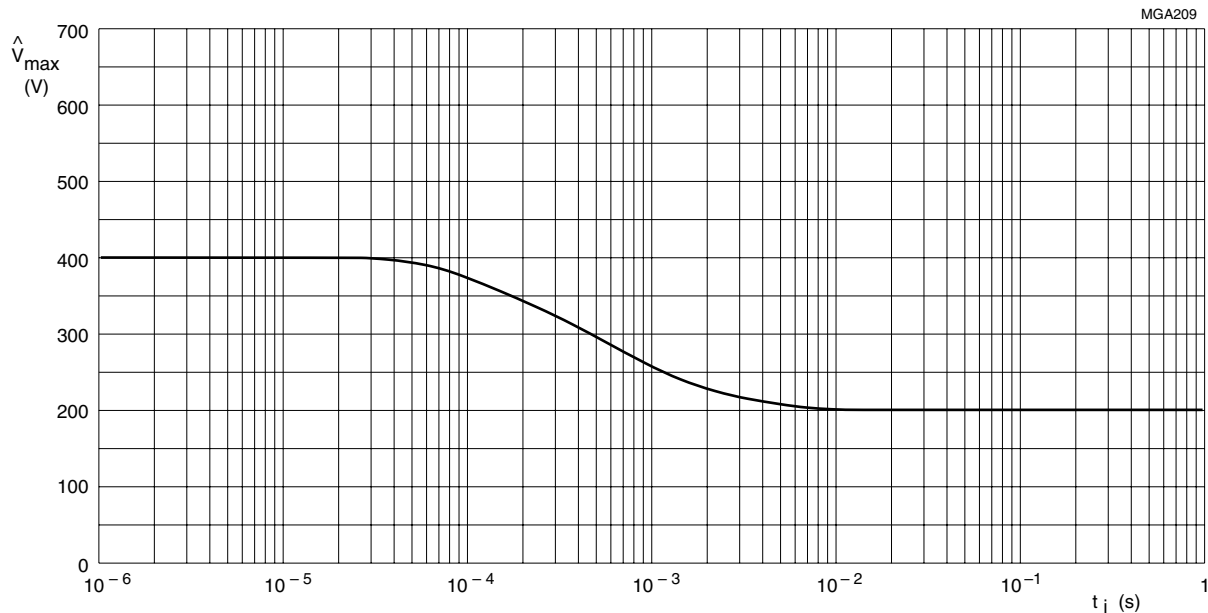

Fig.7 Pulse on a regular basis for type: **RC01**; maximum permissible peak pulse voltage ( $\hat{V}_{max}$ ) as a function of pulse duration.

General purpose chip resistors  
sizes 1206, 0805, 0603 and 0402

RC01/11/21/31  
5%

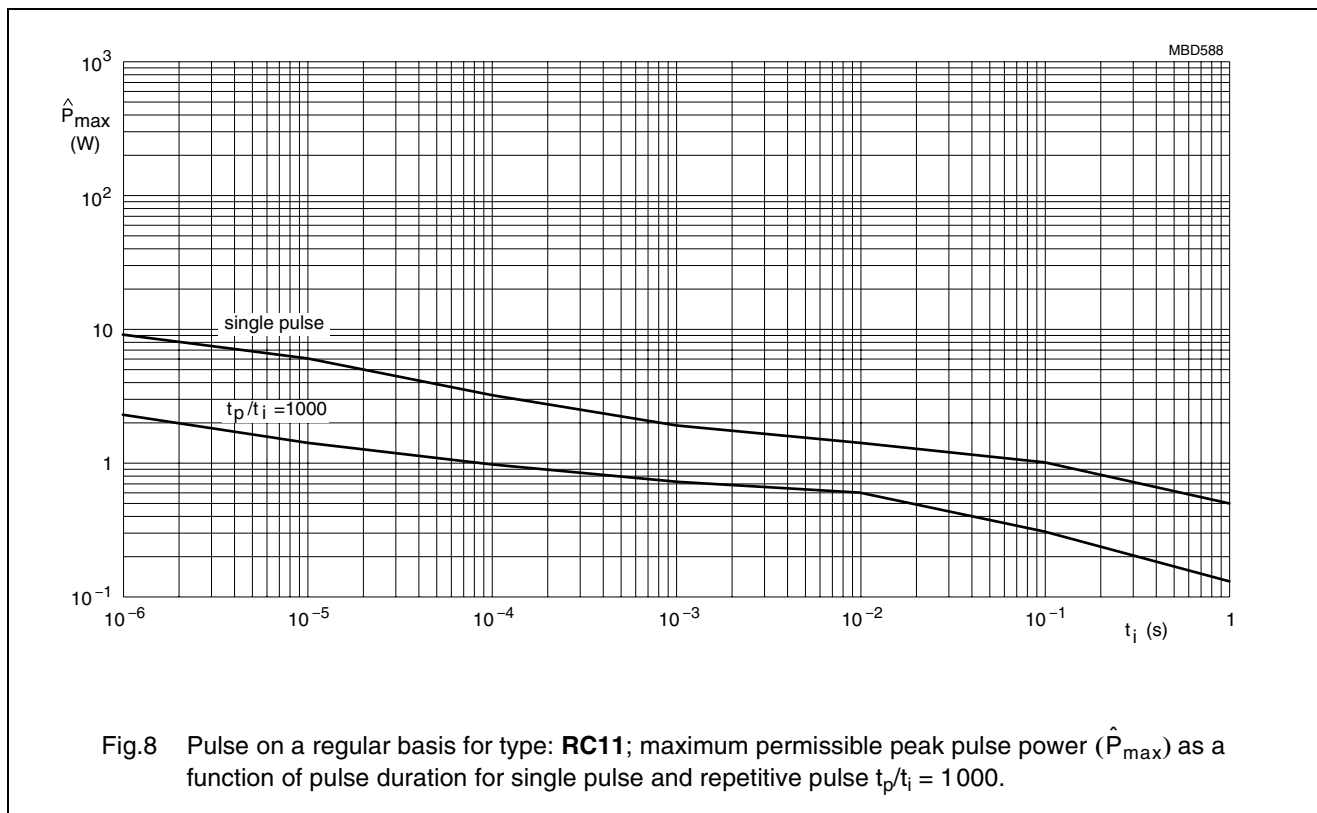

Fig.8 Pulse on a regular basis for type: **RC11**; maximum permissible peak pulse power ( $\hat{P}_{max}$ ) as a function of pulse duration for single pulse and repetitive pulse  $t_p/t_i = 1000$ .

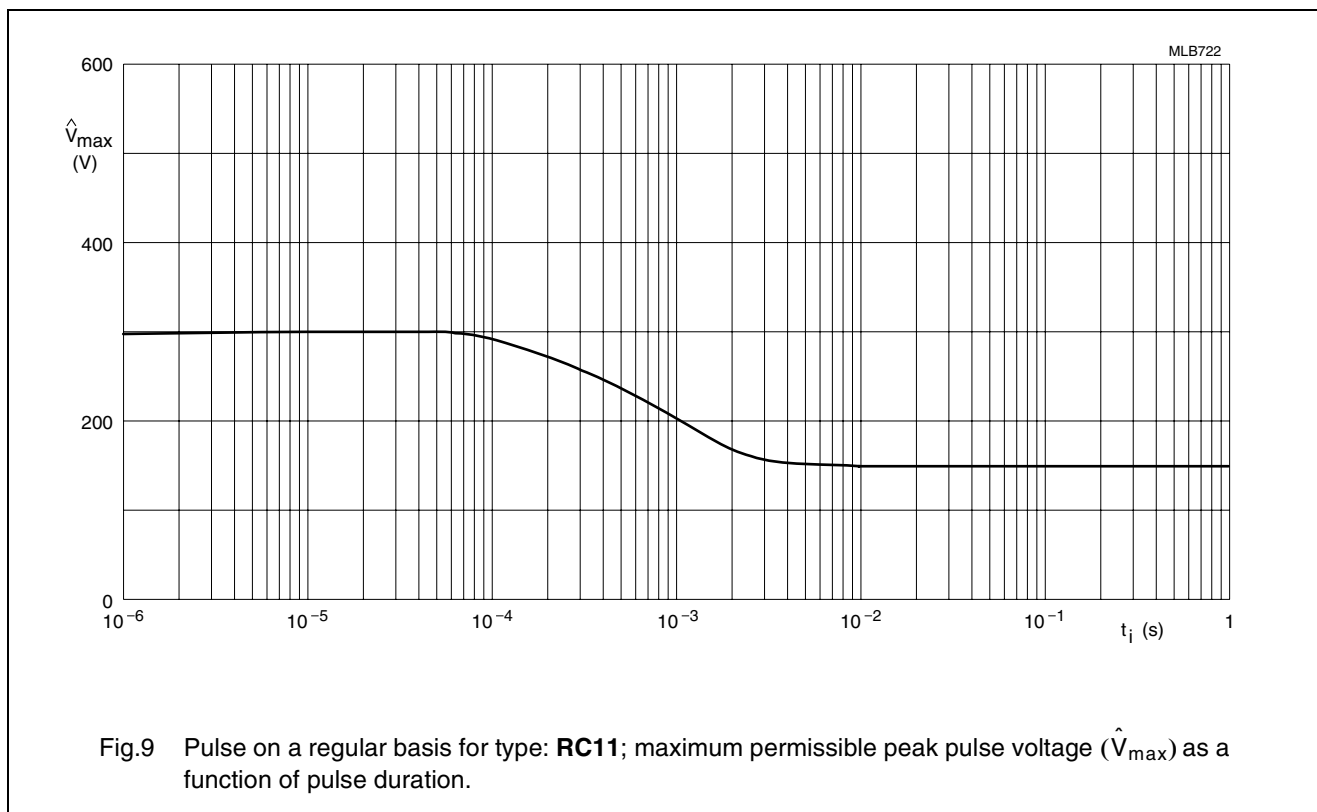

Fig.9 Pulse on a regular basis for type: **RC11**; maximum permissible peak pulse voltage ( $\hat{V}_{max}$ ) as a function of pulse duration.



General purpose chip resistors  
sizes 1206, 0805, 0603 and 0402

RC01/11/21/31  
5%

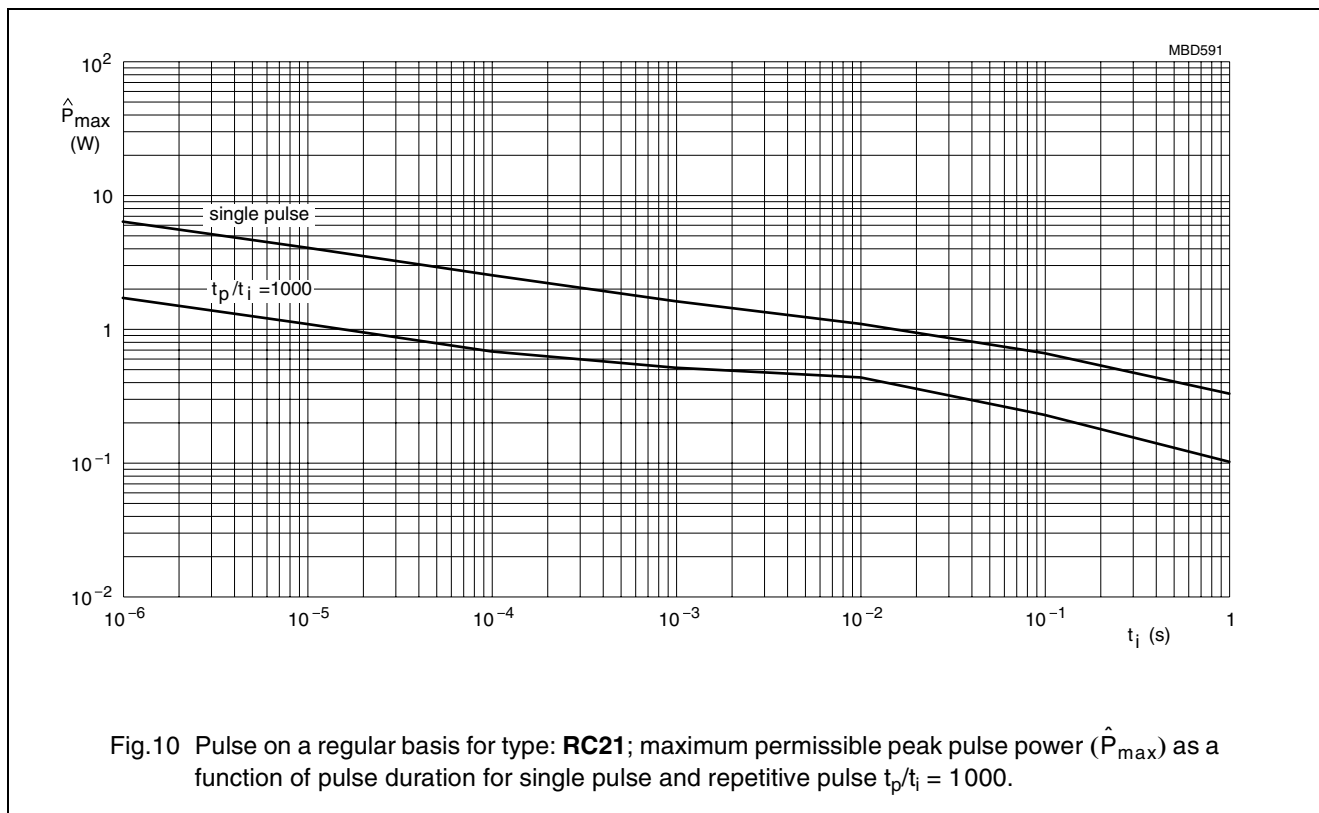

Fig.10 Pulse on a regular basis for type: **RC21**; maximum permissible peak pulse power ( $\hat{P}_{max}$ ) as a function of pulse duration for single pulse and repetitive pulse  $t_p/t_i = 1000$ .

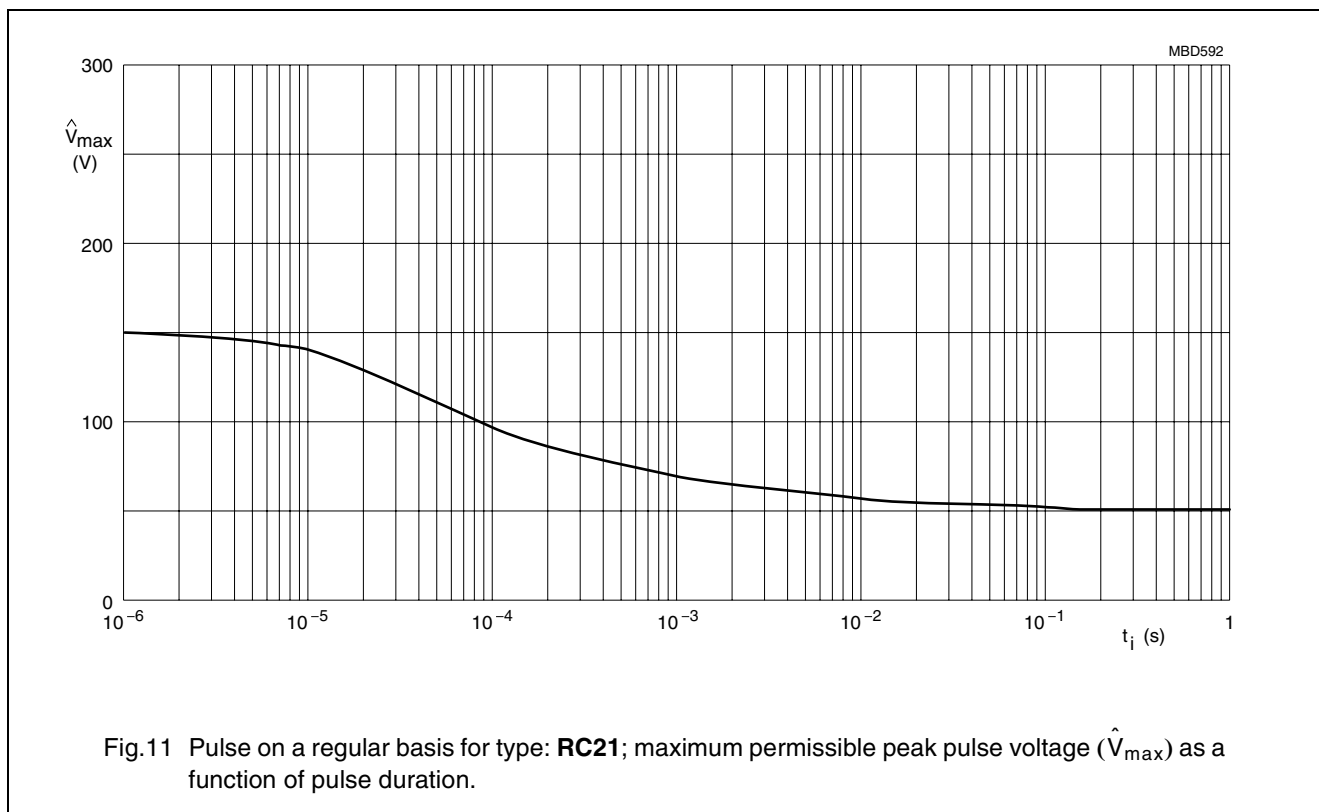
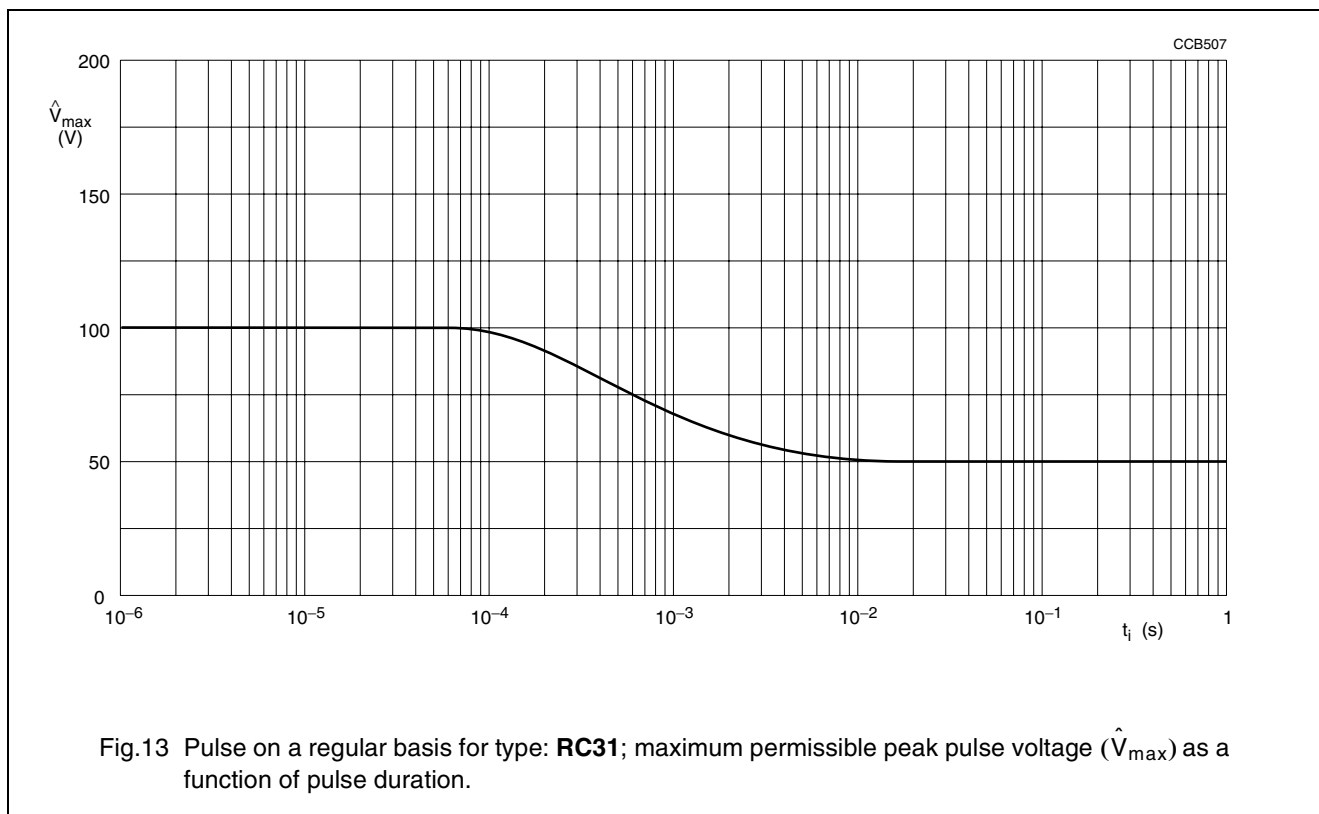
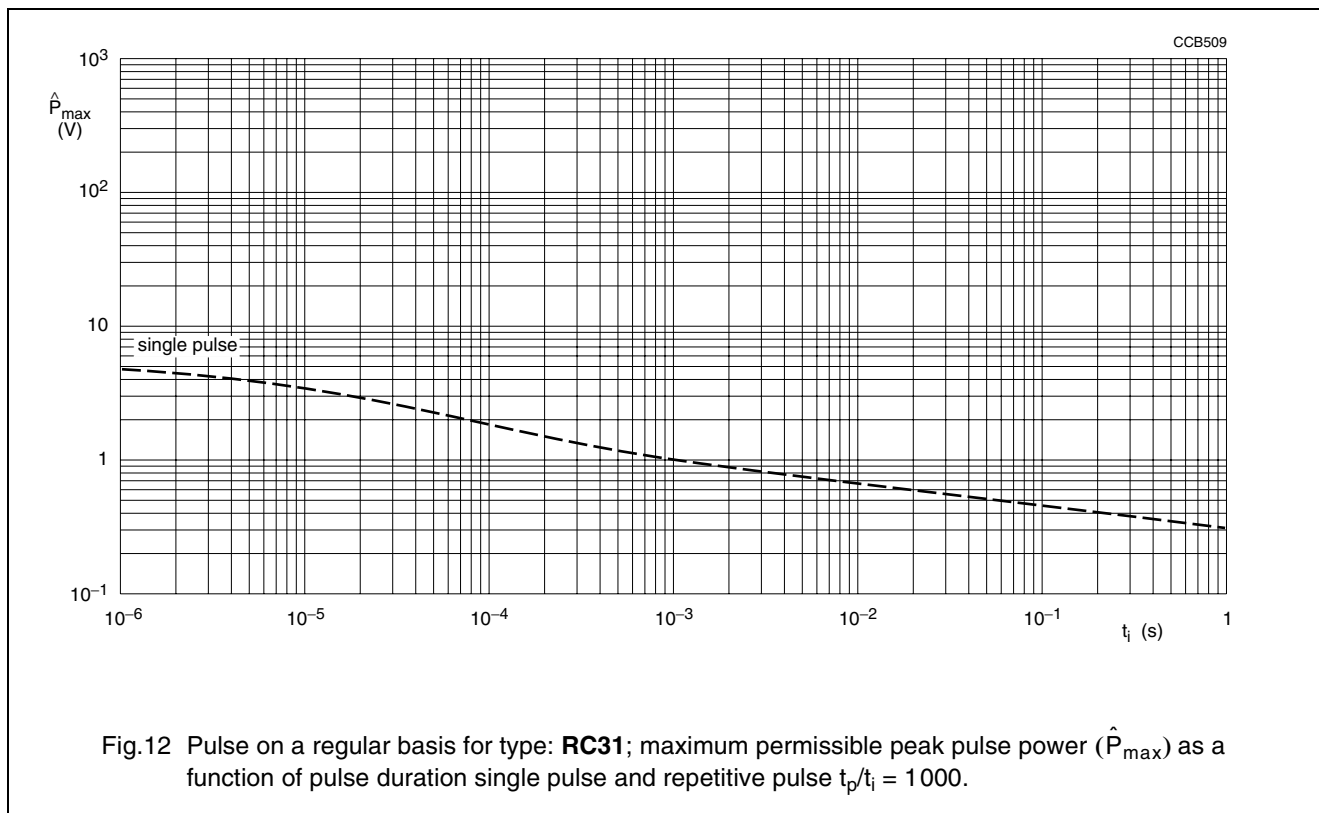

Fig.11 Pulse on a regular basis for type: **RC21**; maximum permissible peak pulse voltage ( $\hat{V}_{max}$ ) as a function of pulse duration.

General purpose chip resistors  
sizes 1206, 0805, 0603 and 0402

RC01/11/21/31  
5%



# General purpose chip resistors

## sizes 1206, 0805, 0603 and 0402

RC01/11/21/31  
5%

### MECHANICAL DATA

#### Mass per 100 units

| TYPE | MASS (g) |
|------|----------|
| RC01 | 1.0      |
| RC11 | 0.55     |
| RC21 | 0.25     |
| RC31 | 0.058    |

#### Marking

Each resistor, except RC31, is marked with a three digit code (occasionally four digit) on the protective coating to designate the nominal resistance value.

#### 3-DIGIT MARKING

For values up to 91  $\Omega$  the R is used as a decimal point. For values of 100  $\Omega$  or greater the first 2 digits are significant, the third indicates the number of zeros to follow.

#### Example

| MARKING | RESISTANCE    |
|---------|---------------|
| 22R     | 22 $\Omega$   |
| 823     | 82 k $\Omega$ |

#### PACKAGE MARKING

The packing is marked with the resistance value, tolerance, catalogue number, quantity, production period, batch number and source code.

### Outlines

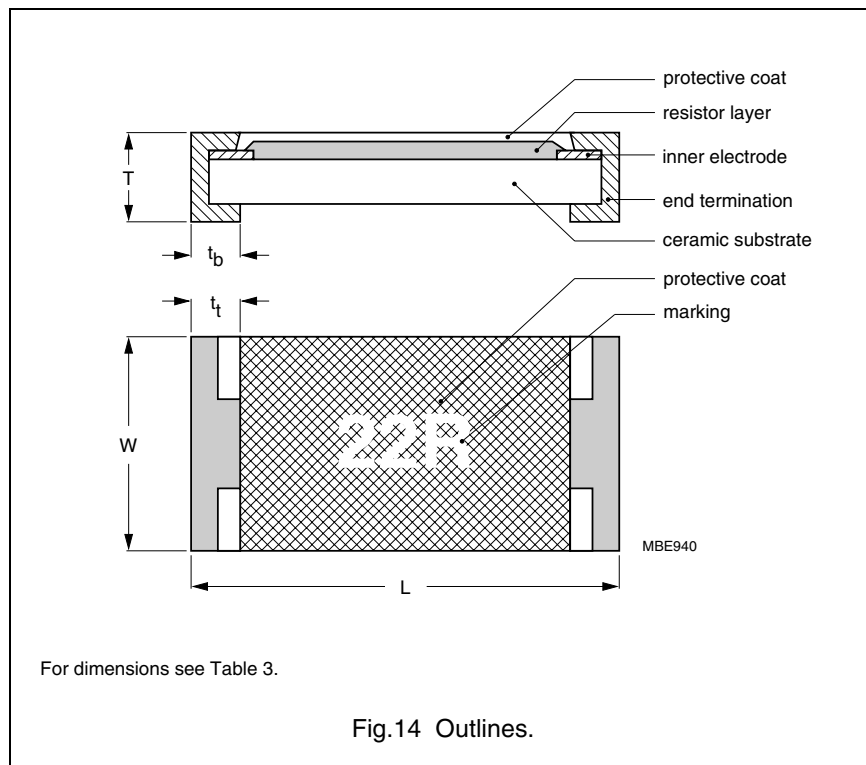

**Table 3** Chip resistor types and relevant physical dimensions; see Fig.14

| TYPE | L (mm)              | W (mm)              | T (mm)     | t <sub>t</sub> (mm) | t <sub>b</sub> (mm) |
|------|---------------------|---------------------|------------|---------------------|---------------------|
| RC01 | 3.20<br>+0.10/-0.20 | 1.60 ±0.15          | 0.55 ±0.10 | 0.45 ±0.25          | 0.50 ±0.25          |
| RC11 | 2.00 ±0.15          | 1.25 ±0.15          | 0.55 ±0.10 | 0.40 ±0.20          | 0.40 ±0.20          |
| RC21 | 1.60 ±0.10          | 0.80<br>+0.15/-0.05 | 0.45 ±0.10 | 0.30 ±0.20          | 0.30 ±0.20          |
| RC31 | 1.00 ±0.05          | 0.50 ±0.05          | 0.35 ±0.05 | 0.20 ±0.10          | 0.25 ±0.10          |

# General purpose chip resistors sizes 1206, 0805, 0603 and 0402

## RC01/11/21/31 5%

### TESTS AND REQUIREMENTS

Essentially all tests are carried out in accordance with the schedule of "IEC publication 60115-8", category **LCT/UCT/56** (rated temperature range: Lower Category Temperature, Upper Category Temperature; damp heat, long term, 56 days). The testing also covers the requirements specified by EIA and EIAJ.

The tests are carried out in accordance with IEC publication 60068, "Recommended basic climatic and mechanical robustness testing procedure for electronic components" and under standard atmospheric conditions according to "IEC 60068-1", subclause 5.3.

Unless otherwise specified the following values apply:

- Temperature: 15 °C to 35 °C
  - Relative humidity: 45% to 75%
  - Air pressure: 86 kPa to 106 kPa (860 mbar to 1060 mbar).
- In Table 4 the tests and requirements are listed with reference to the relevant clauses of "IEC publications 60115-8 and 60068"; a short description of the test procedure is also given. In some instances deviations from the IEC recommendations were necessary for our method of specifying.

All soldering tests are performed with mildly activated flux.

**Table 4** Test procedures and requirements

| IEC<br>60115-8<br>CLAUSE  | IEC<br>60068-2<br>TEST<br>METHOD | TEST                            | PROCEDURE   | REQUIREMENTS                                    |                   |   |
|---|----------------------------------|---------------------------------|---|---|-------------------|---|
|   |                                  |                                 |   | RC01  | RC11              | RC21<br>RC31                                  |
| <b>Tests in accordance with the schedule of IEC publication 60115-8</b> |                                  |                                 |   |   |                   |   |
| 4.4.1   |                                  | visual examination              |   | no holes; clean surface; no visible damage      |                   |   |
| 4.4.2   |                                  | dimensions<br>(see Fig.14)      | gauge (mm)  | see Table 3                                     |                   |   |
| 4.5   |                                  | resistance                      | applied voltage (+0/-10%):<br>R < 10 Ω: 0.1 V<br>10 Ω ≤ R < 100 Ω: 0.3 V<br>100 Ω ≤ R < 1 kΩ: 1 V<br>1 kΩ ≤ R < 10 kΩ: 3 V<br>10 kΩ ≤ R < 100 kΩ: 10 V<br>100 kΩ ≤ R < 1 MΩ: 25 V<br>R ≥ 1 MΩ: 50 V | R – R <sub>nom</sub> : max. ±5%                 |                   |   |
| 4.18  | 20 (Tb)                          | resistance to<br>soldering heat | unmounted chips; 10 ±1 s; 260 ±5 °C   | no visible damage<br>ΔR/R max.: ±(0.5% +0.05 Ω) | no visible damage | no visible damage<br>ΔR/R max.: ±(1% +0.05 Ω) |
| 4.29  | 45 (Xa)                          | component solvent<br>resistance | isopropyl alcohol or H <sub>2</sub> O followed by<br>brushing in accordance with<br>"MIL 202 F"   | no visible damage                               |                   |   |

General purpose chip resistors  
sizes 1206, 0805, 0603 and 0402

RC01/11/21/31  
5%

| IEC<br>60115-8<br>CLAUSE | IEC<br>60068-2<br>TEST<br>METHOD | TEST                                    | PROCEDURE  | REQUIREMENTS   |   |  |      |
|--------------------------|----------------------------------|---|--|--|---|--|------|
|                          |                                  |   |  | RC01   | RC11  | RC21   | RC31 |
| 4.17                     | 20 (Ta)                          | solderability                           | unmounted chips completely immersed for $2 \pm 0.5$ s in a solder bath at $235 \pm 2$ °C   | good tinning ( $\geq 95\%$ covered); no visible damage   |   |  |      |
| 4.7                      |                                  | voltage proof on insulation             | maximum voltage (RMS) during 1 minute metal block method   | no breakdown or flashover  |   |  |      |
| 4.13                     |                                  | short time overload                     | room temperature; $P = 6.25 \times P_n$ ;<br>$5 \text{ s } (V \leq 2 \times V_{\max})$   | $\Delta R/R \text{ max.: } \pm(1\% + 0.05 \Omega)$   | $\Delta R/R \text{ max.: } \pm(2\% + 0.1 \Omega)$ |  |      |
| 4.33                     |                                  | bending                                 | resistors mounted on a 90 mm glass epoxy resin PCB (FR4), bending: 3 mm for <b>RC01</b> and 5 mm for <b>RC11</b> , <b>RC21</b> and <b>RC31</b>   | no visible damage;<br>$\Delta R/R \text{ max.: } \pm(1\% + 0.05 \Omega)$                                 |   |  |      |
| 4.19                     | 14 (Na)                          | rapid change of temperature             | 30 minutes at LCT and 30 minutes at UCT; 5 cycles  | no visible damage;<br>$\Delta R/R \text{ max.: } \pm(0.5\% + 0.05 \Omega)$                               |   |  |      |
| 4.24.2                   | 3 (Ca)                           | damp heat (steady state)                | 56 days; $40 \pm 2$ °C; $93 + 2/-3\%$ RH; loaded with $0.01 P_n$ ;<br>$R \leq 1 \text{ M}\Omega$<br>$R > 1 \text{ M}\Omega$                      | $\Delta R/R \text{ max.: } \pm(1.5\% + 0.1 \Omega)$<br>$\Delta R/R \text{ max.: } \pm(3\% + 0.1 \Omega)$ |   | $\Delta R/R \text{ max.: } \pm(3\% + 0.1 \Omega)$<br>– |      |
| 4.25.1                   |                                  | endurance                               | 1000 +48/-0 hours; loaded with $P_n$ or $V_{\max}$ ;<br>1.5 hours on and 0.5 hours off:<br>$R \leq 1 \text{ M}\Omega$<br>$R > 1 \text{ M}\Omega$ | $\Delta R/R \text{ max.: } \pm(1.5\% + 0.1 \Omega)$<br>$\Delta R/R \text{ max.: } \pm(3\% + 0.1 \Omega)$ |   | $\Delta R/R \text{ max.: } \pm(3\% + 0.1 \Omega)$<br>– |      |
| 4.23.2                   | 27 (Ba)                          | endurance at upper category temperature | 1000 +48/-0 hours; no load:<br>$R \leq 1 \text{ M}\Omega$<br>$R > 1 \text{ M}\Omega$   | $\Delta R/R \text{ max.: } \pm(1.5\% + 0.1 \Omega)$<br>$\Delta R/R \text{ max.: } \pm(3\% + 0.1 \Omega)$ |   | $\Delta R/R \text{ max.: } \pm(3\% + 0.1 \Omega)$<br>– |      |
| 4.8.4.2                  |                                  | temperature coefficient                 | at 20/LCT/20 °C and 20/UCT/20 °C:<br>$R \leq 10 \Omega$<br>$10 \Omega < R$   | $\leq 250 \pm 250 \times 10^{-6}/K$<br>$\leq 200 \times 10^{-6}/K$                                       |   |  |      |

General purpose chip resistors  
sizes 1206, 0805, 0603 and 0402

RC01/11/21/31  
5%

| IEC<br>60115-8<br>CLAUSE  | IEC<br>60068-2<br>TEST<br>METHOD | TEST                               | PROCEDURE  | REQUIREMENTS   |      |      |      |
|---|----------------------------------|------------------------------------|--|--|------|------|------|
|   |                                  |                                    |  | RC01   | RC11 | RC21 | RC31 |
| <b>Other tests in accordance with IEC 60115 clauses and IEC 60068 test method</b> |                                  |                                    |  |  |      |      |      |
| 4.17  | 20 (Ta)                          | solderability<br>(after ageing)    | 8 hours steam or 16 hours 155 °C;<br>unmounted chips completely<br>immersed for 2 ±0.5 s in a solder<br>bath at 235 ±2 °C  | good tinning (≥95% covered); no visible damage   |      |      |      |
| 4.6.1.1   |                                  | insulation<br>resistance           | voltage (DC) after 1 minute,<br>metal block method:<br>100 V for <b>RC01</b> and <b>RC11</b> ,<br>50 V for <b>RC21</b> and <b>RC31</b>   | $R_{ins}$ min.: 10 <sup>3</sup> MΩ   |      |      |      |
| 4.12  |                                  | noise                              | IEC publication 60195<br>(measured with<br>Quantech-equipment):<br>$R \leq 100 \Omega$<br>$100 \Omega < R \leq 1 \text{ k}\Omega$<br>$1 \text{ k}\Omega < R \leq 10 \text{ k}\Omega$<br>$10 \text{ k}\Omega < R \leq 100 \text{ k}\Omega$<br>$100 \text{ k}\Omega < R \leq 1 \text{ M}\Omega$<br>$1 \text{ M}\Omega < R \leq 10 \text{ M}\Omega$ | max. 0.316 $\mu\text{V/V}$ (-10 dB)<br>max. 1 $\mu\text{V/V}$ (0 dB)<br>max. 3 $\mu\text{V/V}$ (9.54 dB)<br>max. 6 $\mu\text{V/V}$ (15.56 dB)<br>max. 10 $\mu\text{V/V}$ (20 dB)<br>max. 32 $\mu\text{V/V}$ (30.10 dB) |      |      |      |
| <b>Other applicable tests</b>   |                                  |                                    |  |  |      |      |      |
| (JIS) C<br>5202 7.9   |                                  | endurance (under<br>damp and load) | 1 000 +48/-0 hours; 40 ±2 °C;<br>93 +2/-3% RH;<br>loaded with $P_n$ or $V_{max}$ ;<br>1.5 hours on and 0.5 hours off:<br>$R \leq 1 \text{ M}\Omega$<br>$R > 1 \text{ M}\Omega$   | $\Delta R/R$ max.: ±(3% +0.1 Ω)<br>$\Delta R/R$ max.: ±(5% +0.1 Ω)<br>good tinning; no leaching  |      |      |      |
| EIA<br>575 3.13   |                                  | leaching                           | unmounted chips; 60 ±1 s; 260 ±5 °C  | good tinning; no leaching  |      |      |      |
| EIA/IS<br>703 4.5   |                                  | load humidity                      | 1 000 +48/-0 hours; 85 ±2 °C;<br>85 ±5% RH;<br>loaded with 0.01 $P_n$ or $V_{max}$ :<br>$R \leq 1 \text{ M}\Omega$<br>$R > 1 \text{ M}\Omega$  | $\Delta R/R$ max.: ±(3% +0.1 Ω)<br>$\Delta R/R$ max.: ±(5% +0.1 Ω)   |      |      |      |

---

General purpose chip resistors  
sizes 1206, 0805, 0603 and 0402

---

RC01/11/21/31  
5%

---

**REVISION HISTORY**

| Revision | Date        | Change Notification | Description   |
|----------|-------------|---------------------|---|
| Rev.8    | 2001 Feb 26 | –                   | - Converted to Phycomp brand<br>- Fig.6 graph corrected<br>- Pulse duration limit for $R \leq 10 \text{ k}\Omega$ removed in Figs.6, 8, 10 and 12<br>- 4-digit marking info removed; does not apply to 5% devices |
| Rev.9    | 2002 Apr 09 | –                   | - Maximum dissipation for RC21 changed from 0.063 W/0.1 W to 0.1 W  |
|          |             |                     |   |