

Amplifier Transistor

PNP Silicon

2N5087

ON Semiconductor Preferred Device

MAXIMUM RATINGS

Rating	Symbol	Value	Unit
Collector–Emitter Voltage	V_{CEO}	50	Vdc
Collector–Base Voltage	V_{CBO}	50	Vdc
Emitter–Base Voltage	V_{EBO}	3.0	Vdc
Collector Current — Continuous	I_C	50	mAdc
Total Device Dissipation @ $T_A = 25^\circ\text{C}$ Derate above 25°C	P_D	625 5.0	mW mW/ $^\circ\text{C}$
Total Device Dissipation @ $T_C = 25^\circ\text{C}$ Derate above 25°C	P_D	1.5 12	Watts mW/ $^\circ\text{C}$
Operating and Storage Junction Temperature Range	T_J, T_{stg}	-55 to +150	$^\circ\text{C}$

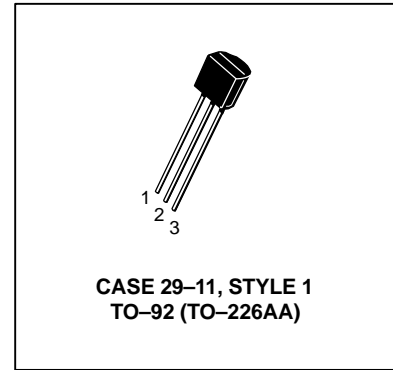

THERMAL CHARACTERISTICS

Characteristic	Symbol	Max	Unit
Thermal Resistance, Junction to Ambient	$R_{\theta JA}$	200	$^\circ\text{C}/\text{W}$
Thermal Resistance, Junction to Case	$R_{\theta JC}$	83.3	$^\circ\text{C}/\text{W}$

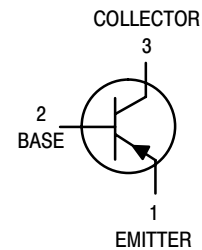

ELECTRICAL CHARACTERISTICS ($T_A = 25^\circ\text{C}$ unless otherwise noted)

Characteristic	Symbol	Min	Max	Unit
----------------	--------	-----	-----	------

OFF CHARACTERISTICS

Collector–Emitter Breakdown Voltage ⁽¹⁾ ($I_C = 1.0 \text{ mAdc}, I_B = 0$)	$V_{(BR)CEO}$	50	—	Vdc
Collector–Base Breakdown Voltage ($I_C = 100 \mu\text{Adc}, I_E = 0$)	$V_{(BR)CBO}$	50	—	Vdc
Collector Cutoff Current ($V_{CB} = 35 \text{ Vdc}, I_E = 0$)	I_{CBO}	—	50	nAdc
Emitter Cutoff Current ($V_{EB} = 3.0 \text{ Vdc}, I_C = 0$)	I_{EBO}	—	50	nAdc

1. Pulse Test: Pulse Width $\leq 300 \mu\text{s}$, Duty Cycle $\leq 2.0\%$.

Preferred devices are ON Semiconductor recommended choices for future use and best overall value.

2N5087

ELECTRICAL CHARACTERISTICS ($T_A = 25^\circ\text{C}$ unless otherwise noted) (Continued)

Characteristic	Symbol	Min	Max	Unit
ON CHARACTERISTICS				
DC Current Gain ($I_C = 100\ \mu\text{Adc}$, $V_{CE} = 5.0\ \text{Vdc}$) ($I_C = 1.0\ \text{mAdc}$, $V_{CE} = 5.0\ \text{Vdc}$) ($I_C = 10\ \text{mAdc}$, $V_{CE} = 5.0\ \text{Vdc}$)(1)	h_{FE}	250 250 250	800 — —	—
Collector-Emitter Saturation Voltage ($I_C = 10\ \text{mAdc}$, $I_B = 1.0\ \text{mAdc}$)	$V_{CE(sat)}$	—	0.3	Vdc
Base-Emitter On Voltage ($I_C = 1.0\ \text{mAdc}$, $V_{CE} = 5.0\ \text{Vdc}$)	$V_{BE(on)}$	—	0.85	Vdc
SMALL-SIGNAL CHARACTERISTICS				
Current-Gain — Bandwidth Product ($I_C = 500\ \mu\text{Adc}$, $V_{CE} = 5.0\ \text{Vdc}$, $f = 20\ \text{MHz}$)	f_T	40	—	MHz
Collector-Base Capacitance ($V_{CB} = 5.0\ \text{Vdc}$, $I_E = 0$, $f = 1.0\ \text{MHz}$)	C_{cb}	—	4.0	pF
Small-Signal Current Gain ($I_C = 1.0\ \text{mAdc}$, $V_{CE} = 5.0\ \text{Vdc}$, $f = 1.0\ \text{kHz}$)	h_{fe}	250	900	—
Noise Figure ($I_C = 20\ \mu\text{Adc}$, $V_{CE} = 5.0\ \text{Vdc}$, $R_S = 1.0\ \text{k}\Omega$, $f = 1.0\ \text{kHz}$) ($I_C = 100\ \mu\text{Adc}$, $V_{CE} = 5.0\ \text{Vdc}$, $R_S = 3.0\ \text{k}\Omega$, $f = 1.0\ \text{kHz}$)	NF	— —	2.0 2.0	dB

1. Pulse Test: Pulse Width $\leq 300\ \mu\text{s}$, Duty Cycle $\leq 2.0\%$.

TYPICAL NOISE CHARACTERISTICS

($V_{CE} = -5.0\ \text{Vdc}$, $T_A = 25^\circ\text{C}$)

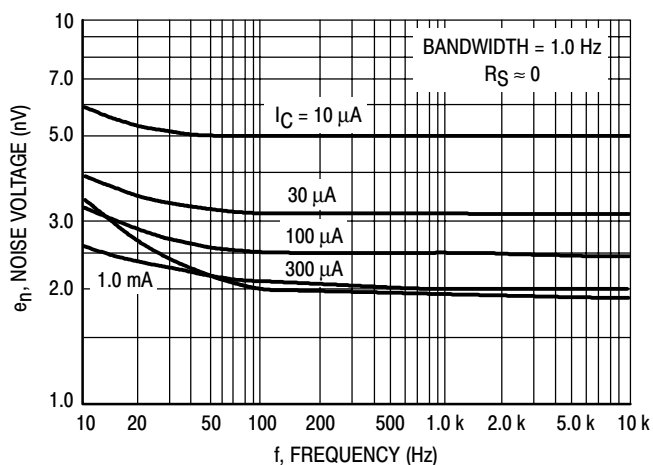

Figure 1. Noise Voltage

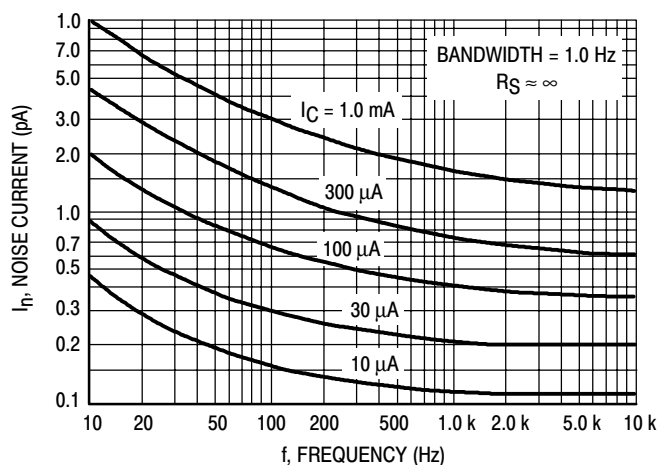

Figure 2. Noise Current

NOISE FIGURE CONTOURS

($V_{CE} = -5.0 \text{ Vdc}$, $T_A = 25^\circ\text{C}$)

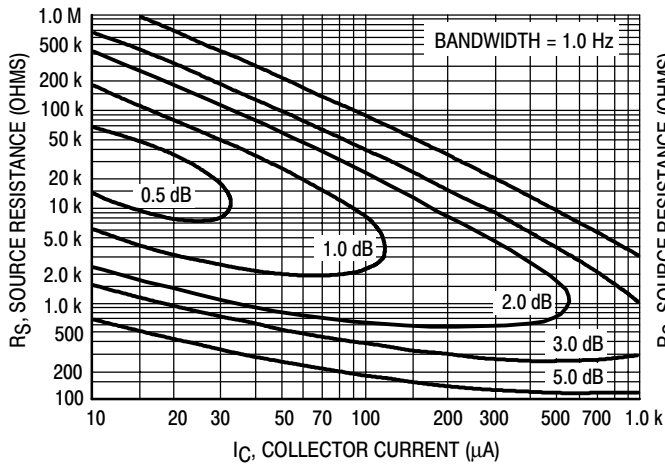

Figure 3. Narrow Band, 100 Hz

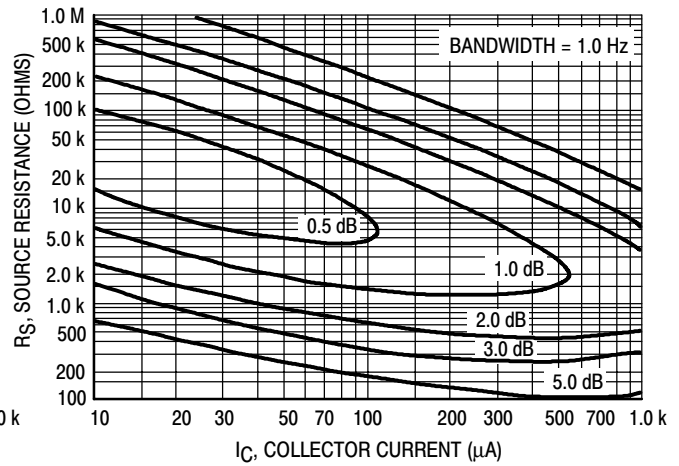

Figure 4. Narrow Band, 1.0 kHz

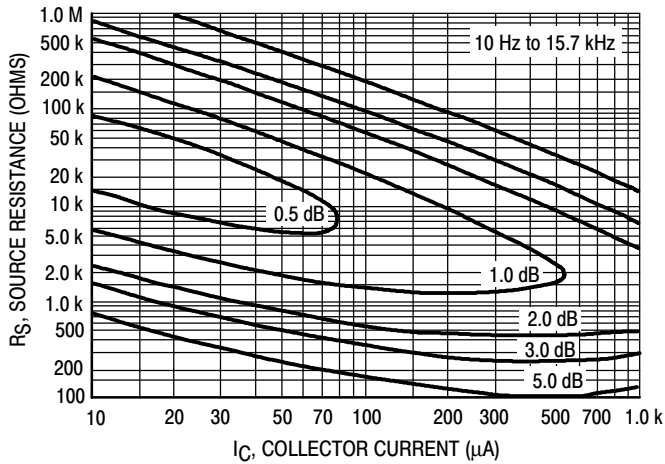

Figure 5. Wideband

Noise Figure is Defined as:

$$NF = 20 \log_{10} \left[\frac{e_n^2 + 4KTR_S + I_n^2 R_S^2}{4KTR_S} \right]^{1/2}$$

e_n = Noise Voltage of the Transistor referred to the input. (Figure 3)

I_n = Noise Current of the Transistor referred to the input. (Figure 4)

K = Boltzman's Constant ($1.38 \times 10^{-23} \text{ J/}^\circ\text{K}$)

T = Temperature of the Source Resistance ($^\circ\text{K}$)

R_S = Source Resistance (Ohms)

TYPICAL STATIC CHARACTERISTICS

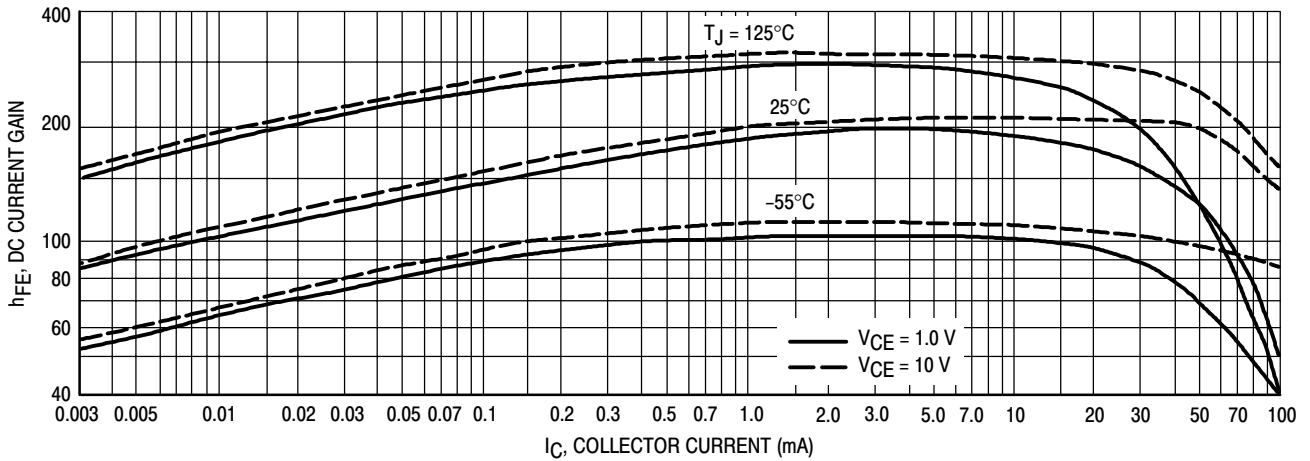

Figure 6. DC Current Gain

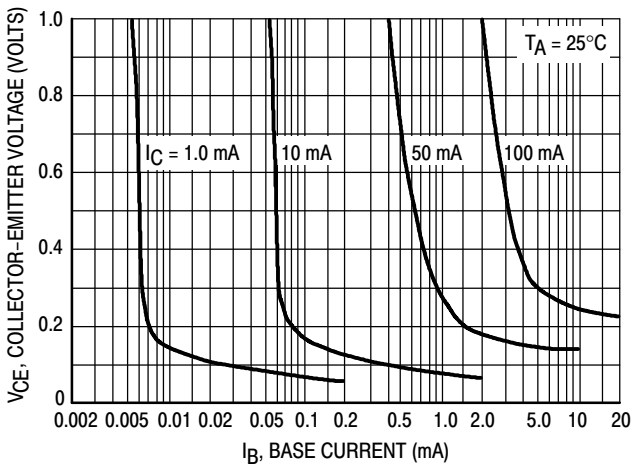

Figure 7. Collector Saturation Region

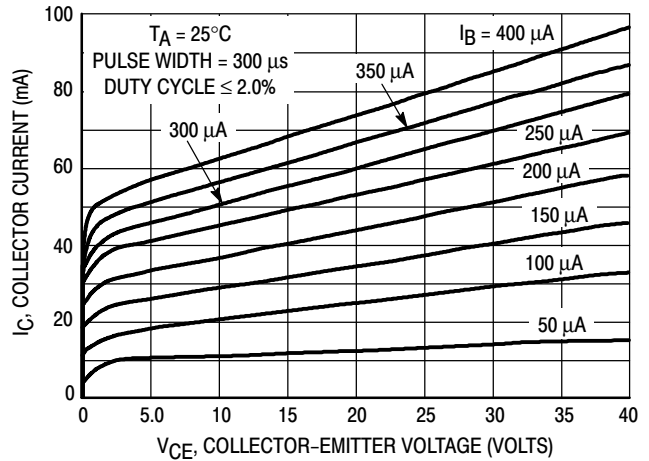

Figure 8. Collector Characteristics

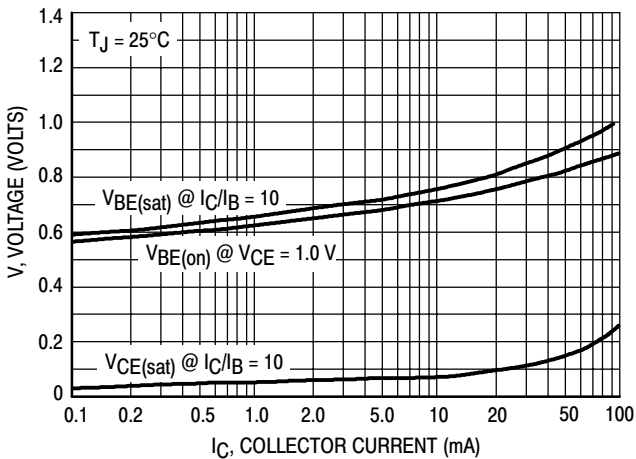

Figure 9. "On" Voltages

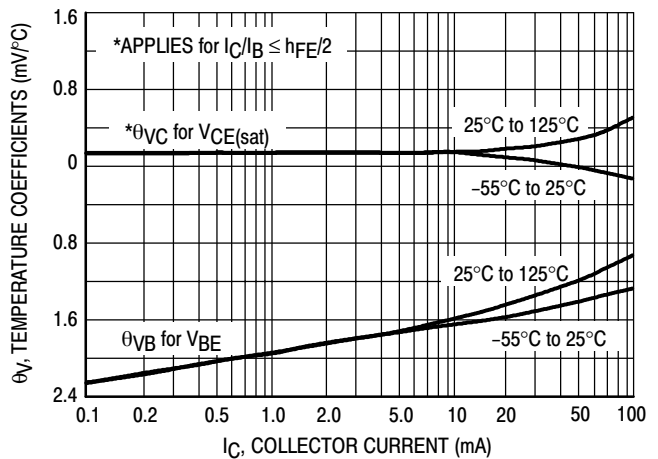

Figure 10. Temperature Coefficients

TYPICAL DYNAMIC CHARACTERISTICS

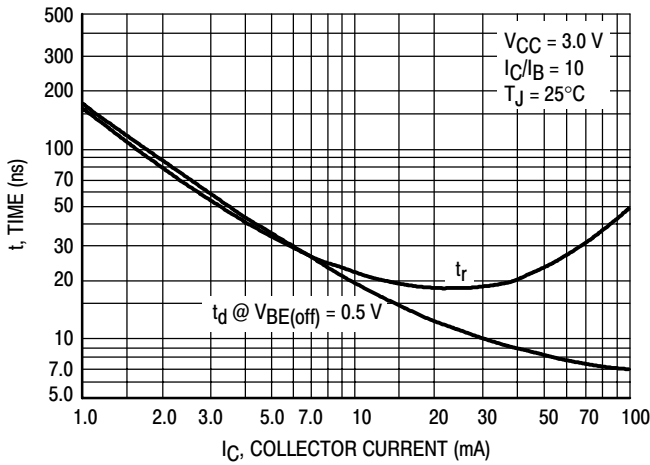

Figure 11. Turn-On Time

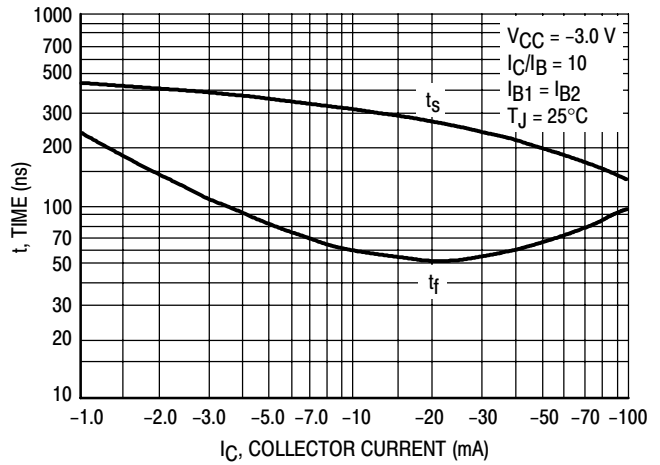

Figure 12. Turn-Off Time

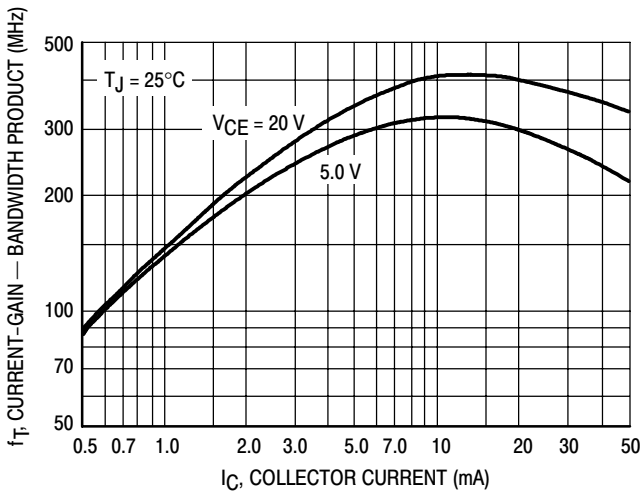

Figure 13. Current-Gain — Bandwidth Product

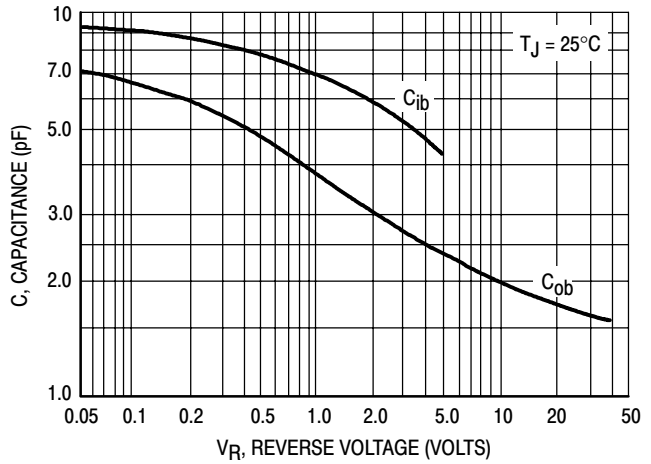

Figure 14. Capacitance

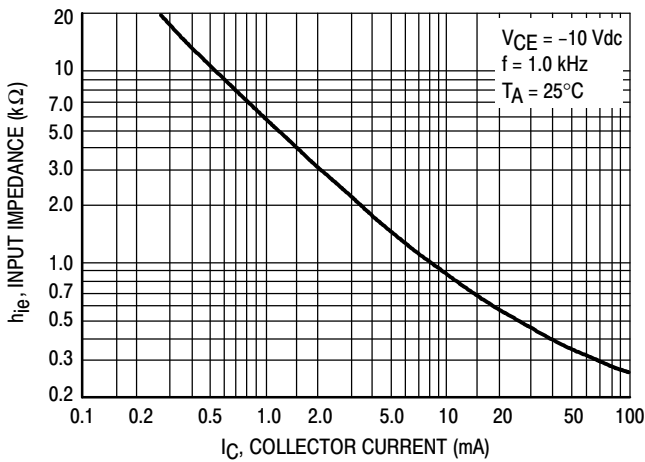

Figure 15. Input Impedance

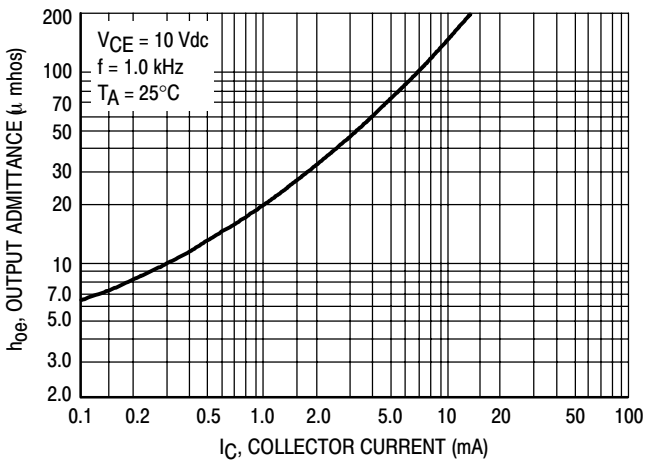

Figure 16. Output Admittance

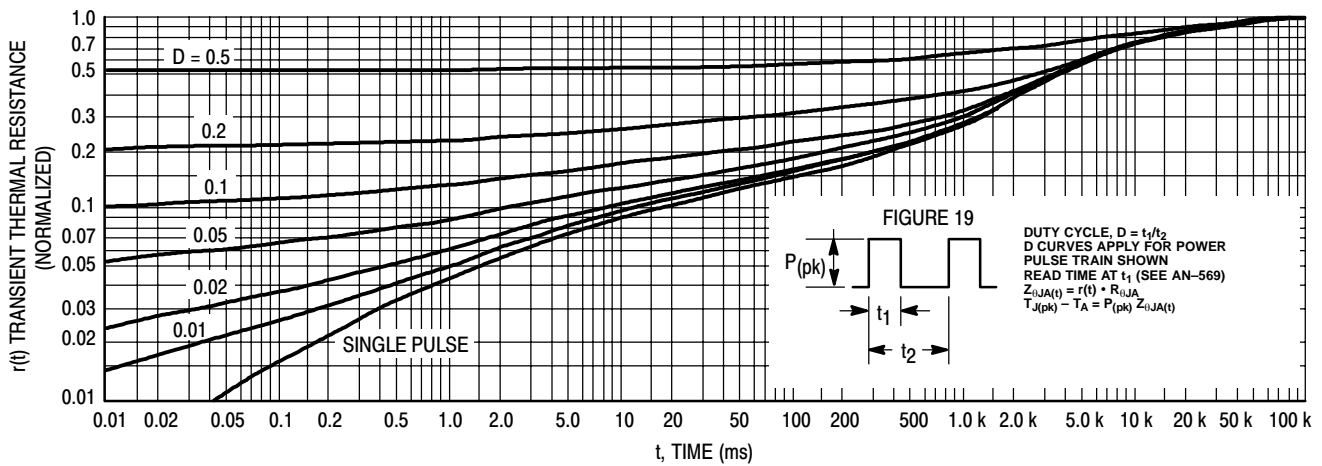

Figure 17. Thermal Response

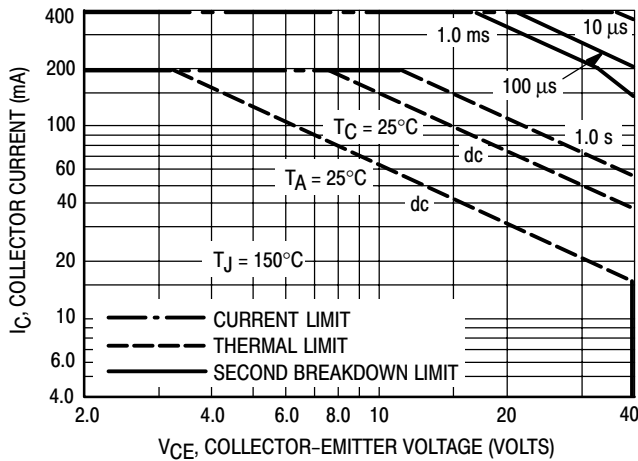

Figure 18. Active-Region Safe Operating Area

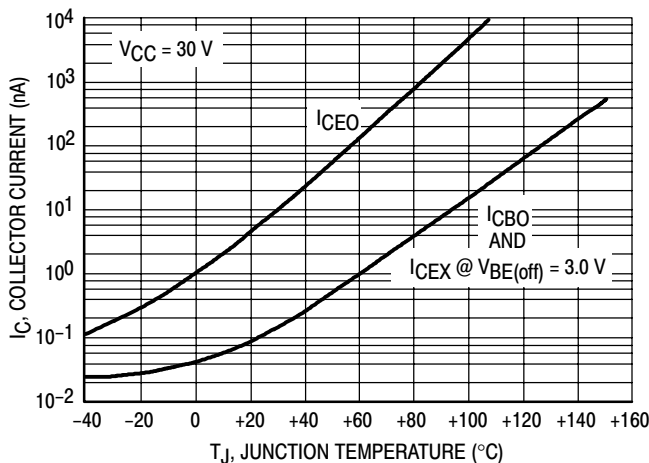

Figure 19. Typical Collector Leakage Current

The safe operating area curves indicate I_C - V_{CE} limits of the transistor that must be observed for reliable operation. Collector load lines for specific circuits must fall below the limits indicated by the applicable curve.

The data of Figure 18 is based upon $T_{J(pk)} = 150^\circ C$; T_C or T_A is variable depending upon conditions. Pulse curves are valid for duty cycles to 10% provided $T_{J(pk)} \leq 150^\circ C$. $T_{J(pk)}$ may be calculated from the data in Figure 17. At high case or ambient temperatures, thermal limitations will reduce the power that can be handled to values less than the limitations imposed by second breakdown.

DESIGN NOTE: USE OF THERMAL RESPONSE DATA

A train of periodical power pulses can be represented by the model as shown in Figure 19. Using the model and the device thermal response the normalized effective transient thermal resistance of Figure 17 was calculated for various duty cycles.

To find $Z_{\theta JA}(t)$, multiply the value obtained from Figure 17 by the steady state value $R_{\theta JA}$.

Example:

The 2N5087 is dissipating 2.0 watts peak under the following conditions:

$$t_1 = 1.0 \text{ ms}, t_2 = 5.0 \text{ ms} (D = 0.2)$$

Using Figure 17 at a pulse width of 1.0 ms and $D = 0.2$, the reading of $r(t)$ is 0.22.

The peak rise in junction temperature is therefore

$$\Delta T = r(t) \times P(pk) \times R_{\theta JA} = 0.22 \times 2.0 \times 200 = 88^\circ C.$$

For more information, see ON Semiconductor Application Note AN569/D, available from the Literature Distribution Center or on our website at www.onsemi.com.

2N5087

PACKAGE DIMENSIONS

TO-92 (TO-226)
CASE 29-11
ISSUE AL

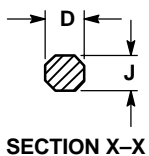
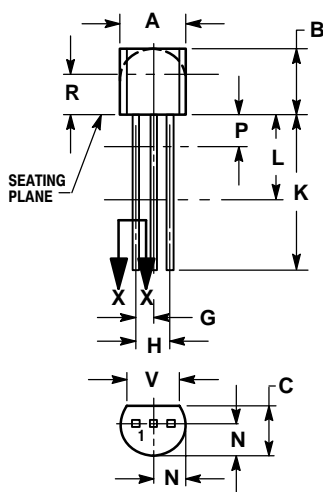

STYLE 1:
PIN 1. EMITTER
2. BASE
3. COLLECTOR

NOTES:

1. DIMENSIONING AND TOLERANCING PER ANSI Y14.5M, 1982.
2. CONTROLLING DIMENSION: INCH.
3. CONTOUR OF PACKAGE BEYOND DIMENSION R IS UNCONTROLLED.
4. LEAD DIMENSION IS UNCONTROLLED IN P AND BEYOND DIMENSION K MINIMUM.

DIM	INCHES		MILLIMETERS	
	MIN	MAX	MIN	MAX
A	0.175	0.205	4.45	5.20
B	0.170	0.210	4.32	5.33
C	0.125	0.165	3.18	4.19
D	0.016	0.021	0.407	0.533
G	0.045	0.055	1.15	1.39
H	0.095	0.105	2.42	2.66
J	0.015	0.020	0.39	0.50
K	0.500	---	12.70	---
L	0.250	---	6.35	---
N	0.080	0.105	2.04	2.66
P	---	0.100	---	2.54
R	0.115	---	2.93	---
V	0.135	---	3.43	---

ON Semiconductor and  are trademarks of Semiconductor Components Industries, LLC (SCILLC). SCILLC reserves the right to make changes without further notice to any products herein. SCILLC makes no warranty, representation or guarantee regarding the suitability of its products for any particular purpose, nor does SCILLC assume any liability arising out of the application or use of any product or circuit, and specifically disclaims any and all liability, including without limitation special, consequential or incidental damages. "Typical" parameters which may be provided in SCILLC data sheets and/or specifications can and do vary in different applications and actual performance may vary over time. All operating parameters, including "Typicals" must be validated for each customer application by customer's technical experts. SCILLC does not convey any license under its patent rights nor the rights of others. SCILLC products are not designed, intended, or authorized for use as components in systems intended for surgical implant into the body, or other applications intended to support or sustain life, or for any other application in which the failure of the SCILLC product could create a situation where personal injury or death may occur. Should Buyer purchase or use SCILLC products for any such unintended or unauthorized application, Buyer shall indemnify and hold SCILLC and its officers, employees, subsidiaries, affiliates, and distributors harmless against all claims, costs, damages, and expenses, and reasonable attorney fees arising out of, directly or indirectly, any claim of personal injury or death associated with such unintended or unauthorized use, even if such claim alleges that SCILLC was negligent regarding the design or manufacture of the part. SCILLC is an Equal Opportunity/Affirmative Action Employer.

PUBLICATION ORDERING INFORMATION

Literature Fulfillment:

Literature Distribution Center for ON Semiconductor
P.O. Box 5163, Denver, Colorado 80217 USA
Phone: 303-675-2175 or 800-344-3860 Toll Free USA/Canada
Fax: 303-675-2176 or 800-344-3867 Toll Free USA/Canada
Email: ONlit@hibbertco.com

N. American Technical Support: 800-282-9855 Toll Free USA/Canada

JAPAN: ON Semiconductor, Japan Customer Focus Center
4-32-1 Nishi-Gotanda, Shinagawa-ku, Tokyo, Japan 141-0031
Phone: 81-3-5740-2700
Email: r14525@onsemi.com

ON Semiconductor Website: <http://onsemi.com>

For additional information, please contact your local Sales Representative.