

454202

# Lenze

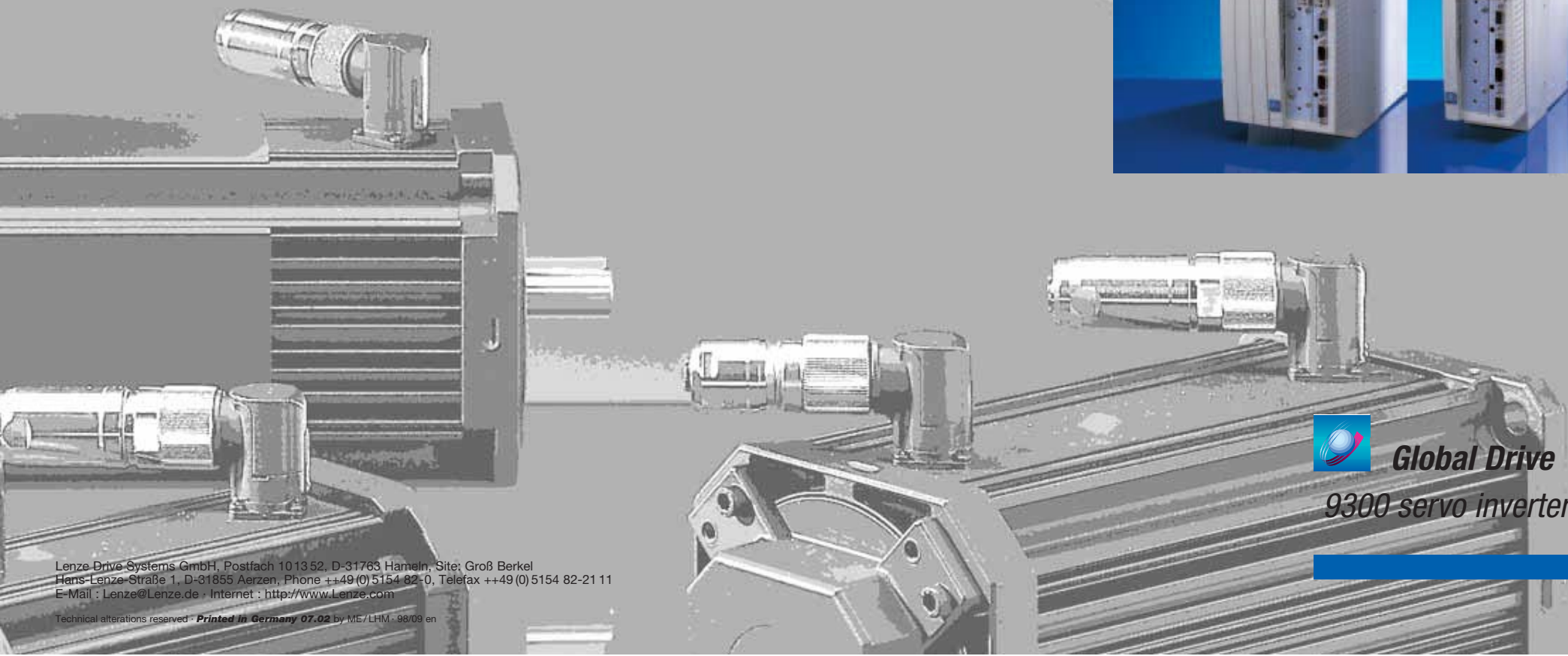

**Global Drive**

*9300 servo inverters*

Lenze Drive Systems GmbH, Postfach 10 13 52, D-31763 Hameln, Site; Groß Berkel  
Hans-Lenze-Straße 1, D-31855 Aerzen, Phone ++49 (0) 5154 82-0, Telefax ++49 (0) 5154 82-21 11  
E-Mail : Lenze@Lenze.de · Internet : <http://www.Lenze.com>

Technical alterations reserved · Printed in Germany 07.02 by ME/LHM · 98/09 en

# Select and order

This catalog helps you to easily select and order your desired servo drive.

This catalog includes:

- Servo inverters for the control of servo motors
- Different servo inverter versions
- Accessories for mounting and wiring of inverters
- Application examples
- Order forms

## 9300 Automation

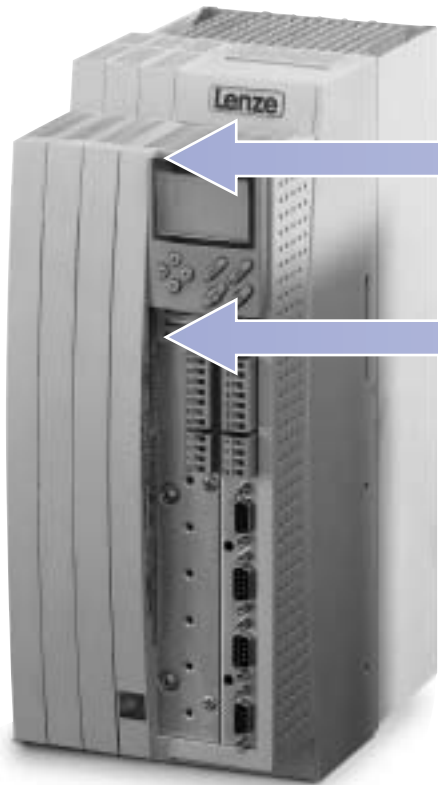

### Communication to host



### System bus components



# 9300 servo drive system overview

Mains

Mains fuses  
or automatic  
circuit breakers  
EFS series...



Mains filter A  
Type EZN3A...



Mains filter B  
EZN3B...

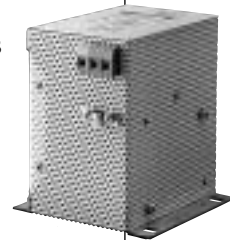

Operation  
module  
EMZ9371BB



Automation  
module  
EMF2xxxIB



Servo  
inverter  
EVS93XX-E

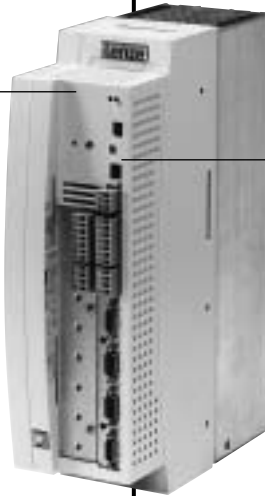

Brake chopper  
ERB...

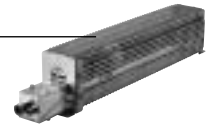

Brake chopper  
EMB9352-E

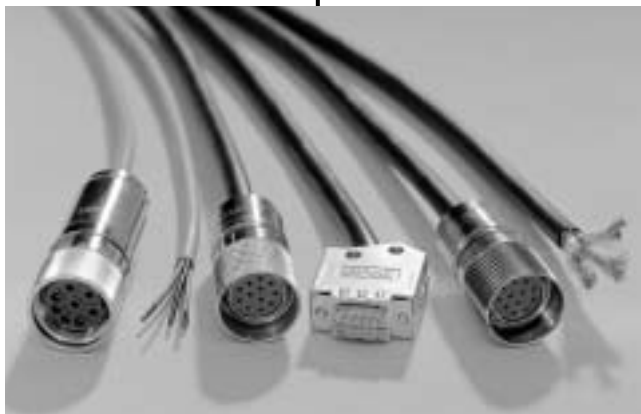

# Introducing Lenze

## Intelligent drives for automation.

Intelligence is a built-in feature of the Lenze Global Drive controllers. When used in any machine, this is a considerable cost benefit for the design engineer.

Starting with the 8200 Global Drive frequency inverters in series production or HVAC and pump technology, frequently used automation functionality (e. g. PID controllers) has been integrated into the device.

Due to their controller structure - that can be freely interconnected internally - the servo inverters, servo register controllers, 9300 servo positioning controllers cut down on the need for external peripherals. For example, the 9300 servo positioning controller includes complete positioning control features via software functions. Every device version contains technology functions that can, for example, execute subprocesses. Additional control elements of the system can be evaluated by means of control inputs and outputs as well as via the system bus.

Intelligent drives have a name: Global Drive.

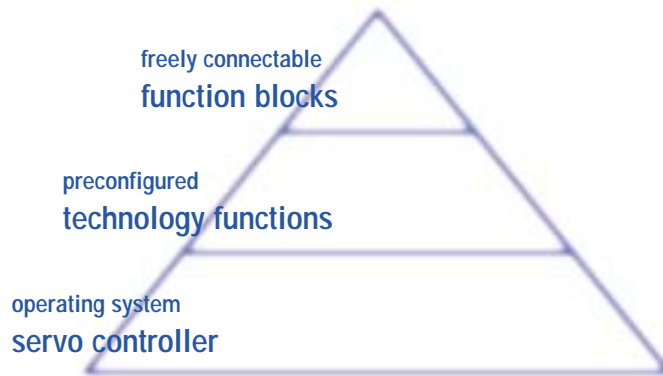



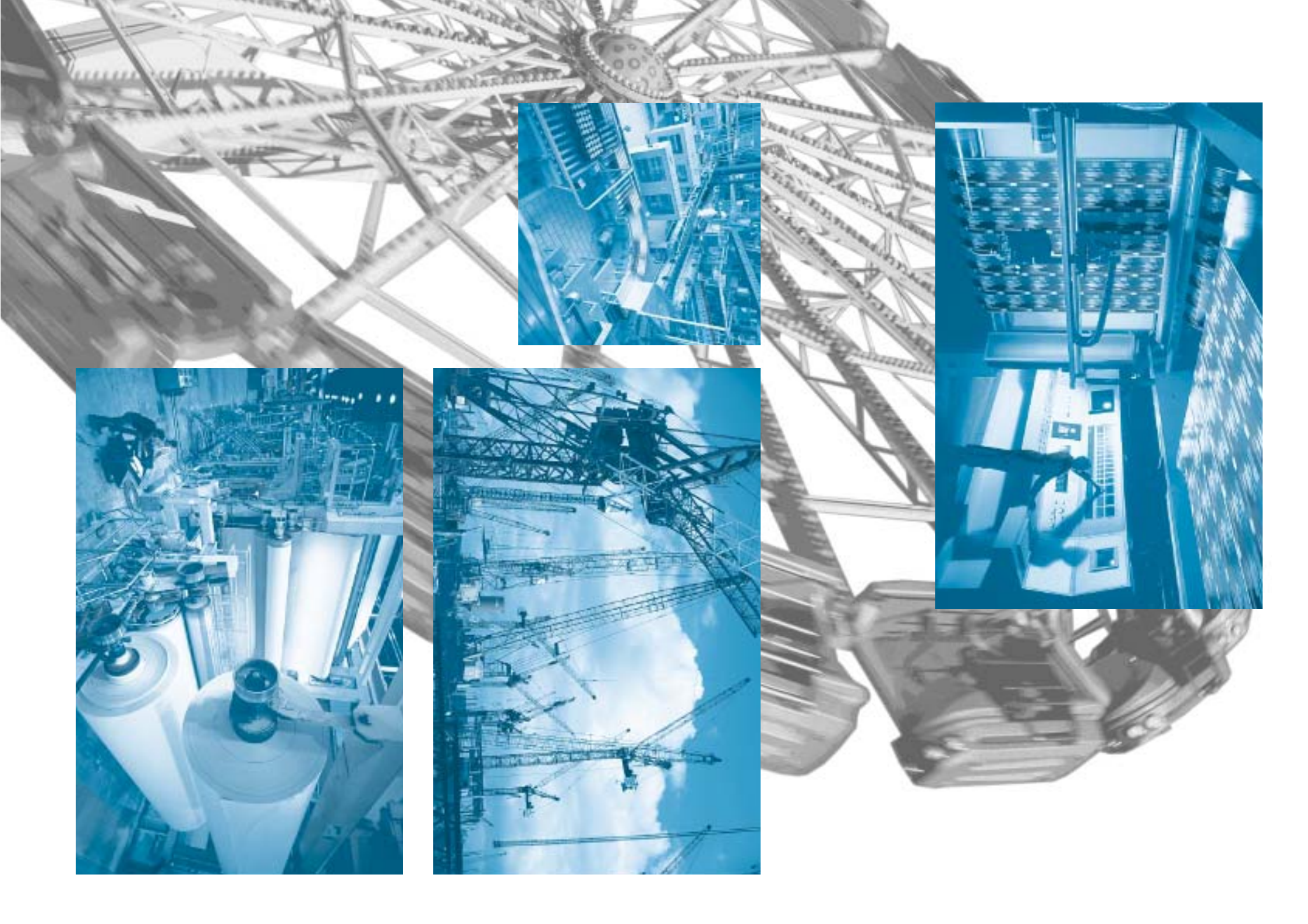



## List of abbreviations

### Abbreviations used in this catalog

#### Controllers

$V_{\text{Mains}}$	[V]	Mains voltage
$I_{\text{Mains}}$	[A]	Mains current
$V_{\text{G}}$	[V]	DC bus voltage
$I_{\text{r}}$	[A]	Rated current / Output current
$I_{\text{max}}$	[A]	Maximum output current
$P_{\text{r}}$	[kW]	Rated motor power
$S_{\text{r}}$	[kVA]	Inverter output power
$P_{\text{loss}}$	[W]	Inverter power loss
$f_{\text{ch}}$	[kHz]	Chopping frequency
$f_{\text{max}}$	[Hz]	Set maximum frequency
$f_{\text{d}}$	[Hz]	Field frequency
$L$	[mH]	Inductance
$R$	[?]	Resistance

#### General

<b>93xxE</b>	9321 to 9332E types
<b>934xE</b>	9341 to 9343E types
<b>935xE</b>	9351 to 9352E types
<b>AC</b>	AC current/voltage
<b>DC</b>	DC current/voltage
<b>DIN</b>	Deutsches Institut für Normung (German Standardization Authority)
<b>EMC</b>	Electromagnetic Compatibility
<b>EN</b>	Europäische Norm (European Standard)
<b>IEC</b>	International Electrotechnical Commission
<b>IP</b>	International Protection Code
<b>NEMA</b>	National Electrical Manufacturers Association
<b>VDE</b>	Verband deutscher Elektrotechniker Association of German Electrical Engineers
<b>CE</b>	Communauté Européenne
<b>IM</b>	International Mounting Code

# Contents

## Product information

Survey	9
Integrated technologies	10
Inverters for your applications	11
General 9300 product information	12

## Order information

Drive selection step-by-step	15
Drive selection	16

## 93xx selection

Features	18
General data	20
Technical data 9321-9325	21
Technical data 9326-9329	22
Technical data 9330-9332	23
Mechanical installation	
General notes	24
Mounting with fixing rail	25
Thermal separation	26
Cable protection	
Survey	27
Cable-protecting fuses	28
Automatic circuit breakers	29
CE-typical installation	
General notes	30
Mains filter A	32
Mains filter B	36
Braking operations	
Options	40
9351 Brake module	41
9352 Brake module	42
Brake resistors	44
Regenerative power supply module	
General data	46
Mains filter A	48
DC bus fuses	49
DC bus connection	50

Operation module	
9371 Operation module	51
Other accessories	
System bus components	52
Digital display/ Setpoint potentiometer	54
Communication via host	
Networking using RS 232/485	56
High-speed networking via host	56
Survey of the accessories	
Accessories for 9300 servo inverters	57
Assigned accessories for 9321-9328 servo inverters	58
Assigned accessories for 9329-9332 servo inverters	59
Assigned accessories for regenerative power supply modules	59
System cables	
General	61
Motor cable	62
Blower cable	64
Resolver- / Encoder cable	65
Other system cables	66

## Application examples

Connecting diagrams	
Power connection	67
Control connection	68
DC-bus connection	69

## Order forms

	70/71
--	-------

## Lenze worldwide

	72/73
--	-------





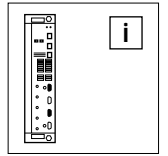

## 9300 servo inverters - flexible and modern automation

Servo inverters of the 9300 series with a matching motor and geared motor programme form a perfect drive system. Market-oriented intelligence enables general technology functions (electrical shaft or positioning control) as well as electronic alternatives to mechanical components (register control, cam profiler).

Thus, costly upgrades with control cams, pull rods, and also clutches are not necessary in the manufacturing process.

These intelligent drives coordinate - accurately and precisely - all different movements of the machines to one another. No matter whether the system is equipped with a central control station or is controlled locally - high flexibility is guaranteed.

This drive concept offers automation solutions based on a consistent platform.

Attachable InterBus and PROFIBUS fieldbus modules are available for the connection to a host control system. The hardware of the servo product series is uniformly equipped with the following features:

Universality - the product series is universally applicable in the power range from 0.37 to 75 kW.

Integrated mains input - for single drive operations only one element instead of two separated elements is required.

Regenerative power supply modules - ensure energy-saving group applications and multi-axis applications.

Feedback systems - ensure a perfect adaptation to the machine requirements by means of resolvers or SinCos feedback.



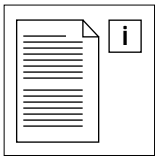

### Integrated technologies

The integrated technology function forms a vital part of the intelligent drive solution. The 9300 servo inverter series comprise four software variants in identical hardware devices:

- 9300 servo
- 9300 register control
- 9300 cam profiler
- 9300 positioning control

All four variants are equipped with a uniform user interface. The respective technology function can be set quickly and easily. In detail:

#### 9300 inverter

This inverter implements frequently used functions of a servo drive. The electronic gearbox is an essential technology function in this device. As an alternative to the mechanical vertical shaft, several drives can be operated at exact synchronisation by master frequency preselection. Proportional synchronisation can be implemented easily and flexibly by means of adjustable gearing. Feedback systems such as resolvers or SinCos encoders provide highest precision.

#### 9300 register control

There are many machines that are processing material lengths. Second printings, cuts, perforations, embossings, or splices require the material length to be positioned precisely to form the resulting print image. However, due to process-dependant fluctuations (material characteristics, production parameters) the position of the print image tends to drift. The basic prerequisite "autosyn" is added by the requirement for overlaid register alignment of the rotative motion at the print image. The register control already integrated in the servo inverter always re-aligns the angular position of draw-in rollers, printing cylinders, or other processing stations with the print image. Thus, second printings, cuts, perforations, embossings, or splices will always be at the required position. Finally, drift errors are a thing of the past. Even without host control and without overlay gearing.

#### 9300 cam profiler

Mechanical cams can be found quite frequently in production machinery. Changing or modifying the product causes lengthy and complicated set-up procedures. The 9300 servo cam profiler can store up to 8 different cam profiles, so that cam profiles can be switched without delay during production. For a multitude of potential applications of the cam profiler a variety of additional functions have been integrated, e. g. electronic cam switches and marker-controlled cam start. Especially for opening and closing of welding bars a function has been integrated in order to achieve constant welding periods at variable clock frequencies.

#### 9300 positioning control

Positioning made deceptively simple. The 9300 positioning control includes a complete position controller with sequence control. Easy commissioning with only few input values is a modern solution as compared with external position controllers and their complicated programming language. Responses from limit switches or other drives can be evaluated at the same time. If the initial position of the product is tainted with considerable tolerances, the target position is reliably found by automatic material correction.

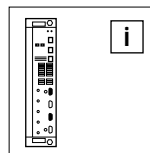

## Inverters for your application

This catalog lists inverters for respective applications. Functions and features of the inverters have been adapted to market requirements.

For the 9300 series the software loaded decides on the available functionality. The following categories are available:

	Printing machines, textile machines, packaging machines	Printing machines, paper machines, packaging, foil processing and textile machines	Packaging machines, production machines, printing machines	Packaging machines, wood processing, warehouse technology
Requirement	High response and comprehensive applications	Insetting, printing, cutting, embossing, perforating, material requirements	Profiling, filling different goods (profile changes)	Exact positioning and comprehensive applications
Single-phase	-	-	-	-
Three-phase	9321-9332 servo	9321-9332 register control	9321-9332 cam disc	9321-9332 positioning control

Compact design	●	●	●	●
Short-circuit protection	●	●	●	●
Vector control	●	●	●	●
Bipolar setpoint	●	●	●	●
Freely assignable inputs and outputs	●	●	●	●
Error signal output	●	●	●	●
DC brake system	●	●	●	●
slip compensation	●	●	●	●
Mains failure monitoring	●	●	●	●
Digital frequency input	●	●	●	●
Sensorless speed control	●			●
Relative/Absolute positioning				●
Homing	●		●	●
Point-to-point positioning				●
Register control		●		
Teach-in for significant web marker		●		
Time or path based generation of correcting variable		●		
Eight selectable profiles			●	
Cam switchgear, switch points			●	●

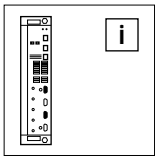

## 9300 product information

### Matched system

- Servo inverters with matched servo motors (asynchronous, synchronous)
- Regenerative power supply modules
- Accessories for braking
- Cold Plate variants for special applications.

### Intelligent drive controller

Ability to execute complete processes or subprocesses through integrated technology and control functionality.

### Easy operation

The 9300 servo inverters can be parameterized using an operation module. This operation module serves as display and for diagnostics. Alternatively, you can use the Global Drive Control operating software.

### Consistency

Across the entire range, the controllers are consistent in power operation networking.

### CE conformity

The servo inverters of the 9300 series naturally meet the EC Directives:

- CE conformity according to the Low-Voltage Directive
- CE conformity according to the Directive of Electromagnetic Compatibility for a typical drive configuration with frequency converter.

### UL approved

The global application of these controllers is ensured by a UL approval. UL 508 and UL-508c ensure the application in the US.

### Communicating

Networks to the most common fieldbus systems are possible:

- LECOM A/B: Networking via RS232/485 interface
- LECOM LI: Networking via fibre optics
- InterBus-S: Connection to the remote bus using DRIVECOM profile 21
- System bus (CAN): Connection to I/O terminals as well as several inverters to each other.
- PROFIBUS: Communication via PROFIBUS-DP.

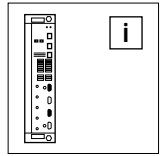

### **Flexibility**

The inverters are equipped for all the different requirements of servo technology, i. e. you can choose among the suitable technique according to your application.

### **Integrated mains input**

For single drive operations only one element instead of two separate elements is required.

### **Regenerative power supply modules**

They ensure energy-saving group applications and multi-axis applications.

### **Feedback systems**

They ensure a perfect adaptation to the machine requirements. You can select among resolver, TTL encoder, or SinCos encoder.

### **Considerably reduced controller requirements because of high functionality:**

- Digital frequency for synchronous running by means of simple plug connectors
- Integrated position controller for exact positioning
- Vector control for highly dynamic response and high starting torque
- Modular design of freely assignable control and function blocks for easy connection
- Process control and arithmetic blocks for control tasks
- Integrated system for interconnection of several controllers.

### **The most suitable setpoint source for each application:**

- Via setpoint potentiometer to the control terminals
- Via master voltage or master current to the control terminals
- Via the operation module at the frequency inverter
- Via a networking module directly from a host

### **Energy-saving**

The power supply is adapted to the load so that only as much energy as required for the momentary torque / current is consumed.

### **Space-saving**

Thanks to their book-shelf design, the frequency inverters can be installed particularly space-saving in the control cabinet, without having to provide free space. Comprehensive mounting accessories allow diverse mounting positions.

### **Motors can be adapted**

The modular design of the motors and planned variants facilitate the right selection for the individual application:

Servo motor flanges with through-holes in B5 mounting or with threaded holes in B14 mounting. Different encoders that can be integrated allow the adaptation to the required precision:

- Resolvers as standard solution
- Optimum behaviour thanks to internal improvement of the resolver accuracy
- Incremental encoders or SinCos absolute value encoders can also be used for special applications.





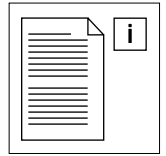

<p>The following chapters of this catalog help you to a tailor-made servo drive for your machinery. Please enter your choice in the order form.</p>	
<p>⇒ This section provides detailed information</p>	<p><b>Example:</b></p>
<p><b>1. Select 93XX-E controller type</b>          (⇒ Selection, technical data)          Select the controller and the servo motor for your drive. The controller type depends on the required motor power.</p>	<ul style="list-style-type: none"> <li>• Servo drive for 11.0 kW motor</li> </ul> <p>EVS9326-E</p>
<p><b>2. Determine the way of installation</b>          (⇒ Selection, mechanical installation)          Select the accessories for the installation of the servo inverter.</p>	<ul style="list-style-type: none"> <li>• Control cabinet in IP41 enclosure</li> <li>• Heat sink is separated, therefore a smaller controller cabinet can be used</li> </ul> <p>Frame for thermal separation EJ0038</p>
<p><b>3. Select accessories at the mains side</b>          (⇒ Selection, electrical installation at the mains side)          Select suitable fuses and accessories required to comply with the limit classes prescribed by the European legislation.</p>	<ul style="list-style-type: none"> <li>• Connection of the drive: to an industrial mains</li> <li>• RFI suppression: The ambience requires limit value class A according to EN 55011</li> </ul> <p>Mains filter EZN3A0150H024</p>
<p><b>4. Select other accessories for the controller</b>          (⇒ Selection, other accessories)          Select useful accessories for the controller:</p> <ul style="list-style-type: none"> <li>- Operation module</li> <li>- Automation accessories</li> <li>- Setpoint potentiometer</li> <li>- System cable</li> </ul>	<ul style="list-style-type: none"> <li>• For analog setpoint input via master voltage or master current:</li> </ul> <p>Setpoint potentiometer ERPD001k0001W          Scale for potentiometer ERZ0002          Knob for potentiometer ERZ0001</p> <ul style="list-style-type: none"> <li>• If you want to change the factory settings in a simple and convenient way:</li> </ul> <p>Operation module EMZ9371BB</p>



# Ordering information

## Drive selection step-by-step

### 1. Motor size and blower type

⇒ Technical data, detailed selection in Lenze formulary	
<ul style="list-style-type: none"> <li>Determine maximum torque <math>M_{max}</math>, maximum speed <math>n_{max}</math>, effective torque <math>M_{rms}</math>, and gear ratio <math>i</math>, if necessary</li> </ul>	
<b>Gear ratio:</b> - for <b>optimum dynamic response</b>	- for good utilization ratio for <b>continuous duty</b>
$i \approx \sqrt{\frac{J_{load}}{J_{motor}}}$	$i \approx \frac{n_r}{n_{load}}$
<b>Effective torque:</b> $M_{rms} = \sqrt{\frac{1}{T} \sum_i M_i^2 t_i}$	
<b>Maximum torque:</b> $M_{max} = M_{accel} + \frac{1}{i} \frac{1}{\eta_{gear}} M_{load}$ $M_{accel} = 2 \cdot \pi \frac{\Delta n}{\Delta t} (J_{motor} + \frac{1}{i^2} J_{load})$	
Select motor according to $n_{max}$ , $M_r > M_{rms}$ and take into consideration: <ul style="list-style-type: none"> <li>- <b>No air stream</b> allowed at process → Motor without blower MDSK</li> <li>- <b>Fluff</b> or similar material that may clog air ducts → Motor without blower MDSK</li> <li>- <b>High protection rating</b> required → Motor without blower MDSK</li> <li>- <b>High dynamic response</b> required → Motor with blower MDFK, → Synchronous servo motor MDXKS</li> <li>- Operation with <b>constant power</b> at high speeds (field weakening operation) → Asynchronous servo motor MDXKA</li> <li>- Very high <b>power density</b> → Synchronous servo motor MDXKS</li> <li>- <b>Parallel operation</b> of servo motors at one single inverter → Asynchronous servo motors MDXKA</li> </ul>	

Example: MDFKA 080-22, 120 Hz  
Asynchronous servo motor with external blower,  
3.9 kW, 10.8 Nm, 3455 rpm

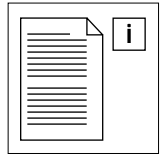

### 2. Selecting the encoder

Encoder	Resolver	Single-turn SinCos encoder	Multi-turn SinCos encoder
available for			
Synchronous servo motor MDXKS	•	•	•
Asynchronous servo motor MDXKA, surface-cooled	•	•	•
Asynchronous servo motor MDXKA, enclosed-ventilated	•	•	•
Abbreviation	RS	AS512	AM512
Type		SCS 70	SCM 70
Signals		512 periods, sine wave signals 1 Vpp	512 periods, sine wave signals 1 Vpp
Resolution	0.8 '	0.4 '	0.4 '
Accuracy	± 10 ' resp. ± 4 ' for correction code input	± 0.8 '	± 0.8 '
Absolute positioning	1 turn	1 turn	4096 turns
Comments	<b>Standard solution</b> for most applications	Uses SinCos encoder instead of resolver, actual position via 9300 interface, operation only possible when encoder at 9300 has been selected, (encoder type and supply voltage) values have been stored, and controller has been switched off and on	

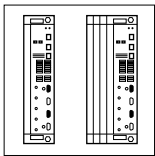

## 9300 Selection

### Features

Compact servos and position controllers for single-phase mains connection:

	Servo EVS93XX-ES 0.37-75.0 kW	Position controller EVS93XX-EP 0.37-75.0 kW
Single axis in narrow design	●	●
Heatsink can be separated	●	●
Power connection at the top	●	●
Motor connection at the bottom	●	●
Direct connection of resolver and encoder, TTL or SinCos	●	●
Phase controller can be integrated	●	●
Motor-phase monitoring for asynchronous motor	●	●
Mains failure monitoring	●	●
Field-oriented control	●	●
Sensorless speed control (SSC technology)	●	●
Digital synchronization system via digital frequency	●	●
Integrated digital-frequency input and output	●	●
User configuration	●	●
Modular function blocks	●	●
Process controller and arithmetic blocks	●	●
Integrated system bus interface (CAN)	●	●
UL approval, file no. 132659 (listed)	●	●
Point-to-point positioning with/without overshooting		●
Easy programming via 32 program sets (PS) and variable tables (VT)		●
Relative / absolute positioning		●
Direct evaluation of a SinCos absolute value encoder	●	●
Switch the outputs, query the inputs		●
Set reference and actual position value		●
Initiate program branches depending on digital input		●
Initiate program branches depending on piece counter		●
Touch-probe positioning		●
Manual positioning		●
Switching points		●
Switching points dynamically adjustable		●
sin <sup>2</sup> ramps		●
Acceptance of new drive profile parameters during ongoing positioning procedure		●
Override (speed and acceleration)		●
Hand teach-in		●
Arithmetic linking of target positions		●
Manual positioning with intermediate stop		●
PFB actual position actual value storage by touch-probe		●
Freely assignable input variables for analog, binary, and BCD values		●
Standby operation, switch-over from positioning to phase-synchronous running		●
Can-bus synchronization of the position controller		●
Various function blocks for long value arithmetic and signal type conversion		●
<b>Attachable accessories</b>		
Operation module 9371BB for parameterization and parameter transfer	●	●
Serial RS232/485 module via wire or 2102IB fibre optics	●	●
2111IB InterBus-S module	●	●
2131IB PROFIBUS module	●	●



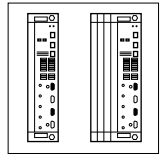

Compact register controllers and cam profilers for three-phase mains connection:

	Register controller EVS93XX-ER 0.37-75.0 kW	Cam profiler EVS93XX-EK 0.37-75.0 kW
Single axis in narrow design	●	●
Heatsink can be separated	●	●
Power connection at the top	●	●
Motor connection at the bottom	●	●
Direct connection of resolver and encoder, TTL or SinCos	●	●
Phase controller can be integrated	●	●
Motor-phase monitoring for asynchronous motor	●	●
Mains failure monitoring	●	●
Field-oriented control	●	●
Sensorless speed control (SSC technology)	●	●
Digital synchronization system via digital frequency	●	●
Integrated digital-frequency input and output	●	●
User configuration	●	●
Modular function blocks	●	●
Process controller and arithmetic blocks	●	●
Integrated system bus interface (CAN)	●	●
UL approval, file no. 132659 (listed)	●	●
Direct evaluation of SinCos absolute value encoders	●	●
Register correction during running	●	
Integrated servo controller for gear ratio compensation	●	
Teach-in function for determination of significant web mark	●	
Adjustable window for marker detection	●	
Mark sensor monitoring	●	
Dead time compensation of sensor system	●	
Adaptable controller characteristics	●	
Preselection of product data in mm or inch (time- and path-dependant)	●	
Variable correction variable limiting	●	
Eight profiles stored in the controller		●
Integrated cam switch		●
Throw-in / throw-out		●
Stretching / compression of cam		●
Offset in x and y direction		●
Virtual master		●
Welding bar control		●
Cam profile start by external signal		●
<b>Attachable accessories</b>		
Operation module 9371BB for parameterization and parameter transfer	●	●
Serial RS232/485 module via wire or 2102IB fibre optics	●	●
2111IB InterBus-S module	●	●
2131IB PROFIBUS module	●	●

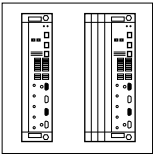

## 9300 Selection

### General data

Range	Values
Vibration resistance	Germanischer Lloyd, general conditions
Humidity	Humidity class F without condensation (average relative humidity 85 %)
Permissible temperature ranges	during transport of the controller: -25 °C ... +70 °C during storage of the controller: -25 °C ... +55 °C during operation of the controller: 0 °C ... +40 °C +40 °C ... +50 °C with power derating 2.5 % per K
Permissible installation height h	up to 1000m a.m.s.l. without power derating 1000 m a.m.s.l. ... 4000 m a.m.s.l. 5 % / 1000 m
Degree of pollution	VDE 0110 part 2 pollution degree 2
Noise emission	Requirements to EN 50081-1, EN 50081-2, IEC 22G-WG4 (Cv) 21 Limit value class A to EN 55011 (industrial area) with mains filter Limit value class B to EN 55022 (residential area) with mains filter and installation into control cabinet
Noise immunity	Limit values maintained using mains filter. Requirements to EN 50082-2, IEC 22G-WG4 (Cv) 21. <b>Requirements Standard Severity levels</b> ESD EN61000-4-2 3, d. h. 8 kV for air discharge and 6 kV for contact discharge RF interference (enclosure) EN61000-4-3 3, i. e. 10 V/m; 27 to 1000 MHz Burst EN61000-4-4 3/4, i. e. 2 kV/5 kHz Surge (on mains cable) IEC 1000-4-5 3, i. e. 1.2/50 ms 1 kV phase-to-phase, 2 kV Phase-PE
Dielectric strength	Surge strength class III according to VDE 0110
Packaging	according to DIN 4180 - 9321 to 9326: packaging for protection against dust - 9327 to 9332: packaging ready for dispatch
Type of protection	IP20 IP41 on the heatsink side for thermal separation in push-through technique NEMA 1: Protection against contact
Approvals	CE: Low-Voltage Directive UL 508: Industrial Control Equipment UL 508C: Power Conversion Equipment

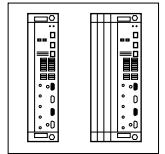

Type		9321	9322	9323	9324	9325
Servo order No.		EVS9321-ES	EVS9322-ES	EVS9323-ES	EVS9324-ES	EVS9325-ES
Register control order No.		EVS9321-ER	EVS9322-ER	EVS9323-ER	EVS9324-ER	EVS9325-ER
Cam disc order No.		EVS9321-EK	EVS9322-EK	EVS9323-EK	EVS9324-EK	EVS9325-EK
Position controller order No.		EVS9321-EP	EVS9322-EP	EVS9323-EP	EVS9324-EP	EVS9325-EP
Mains voltage	$V_r$ [V]	320 V ... 528 V $\pm$ 0 % ; 45 Hz ... 65 Hz $\pm$ 0%				
Alternative DC supply	VG [V]	460 V ... 740 V $\pm$ 0%				
<b>Ratings for operation at a mains: 3 AC / 400 V / 50 Hz / 60 Hz</b>						
Motor power (4-pole ASM)	$P_r$ [kW]	0.37	0.75	1.5	3.0	5.5
Output current (8 kHz)	$I_{r8}$ [A]	1.5 / 1.05 <sup>1)</sup>	2.5 / 1.7 <sup>1)</sup>	3.9 / 2.6 <sup>1)</sup>	7.0 / 4.7 <sup>1)</sup>	13.0
Output current (16 kHz)	$I_{r16}$ [A]	1.1 / 0.77 <sup>1)</sup>	1.8 / 1.26 <sup>1)</sup>	2.9 / 2.03 <sup>1)</sup>	5.2 / 3.64 <sup>1)</sup>	9.7
Output power	$S_{r8}$ [kVA]	1.0	1.7	2.7	4.8	9.0
<b>Ratings for operation at a mains: 3 AC / 480 V / 50 Hz / 60 Hz</b>						
Motor power (4-pole ASM)	$P_r$ [kW]	0.37	0.75	1.5	3.0	5.5
Output current (8 kHz)	$I_{r8}$ [A]	1.5 / 1.05 <sup>1)</sup>	2.5 / 1.7 <sup>1)</sup>	3.9 / 2.6 <sup>1)</sup>	7.0 / 4.7 <sup>1)</sup>	13.0
Output current (16 kHz)	$I_{r16}$ [A]	1.1 / 0.77 <sup>1)</sup>	1.8 / 1.26 <sup>1)</sup>	2.9 / 2.03 <sup>1)</sup>	5.2 / 3.64 <sup>1)</sup>	9.7
Output power	$S_{r8}$ [kVA]	1.2	2.1	3.2	5.8	10.8
Max. output current at 8 kHz	$I_{max}$	2.3 / 3.0 <sup>1)</sup>	3.8 / 5.0 <sup>1)</sup>	5.9 / 7.8 <sup>1)</sup>	10.5 / 14 <sup>1)</sup>	19.5
Max. output current at 16 kHz	$I_{max}$	1.65 / 2.2 <sup>1)</sup>	2.7 / 3.6 <sup>1)</sup>	4.4 / 5.8 <sup>1)</sup>	7.8 / 10.4 <sup>1)</sup>	14.6
Mains current at $V_{mains}$ 400 V	$I_r$ [A]	1.5	2.5	3.9	7.0	12.0
Motor voltage	$V_M$ [V]	3 ~ 0 ... $V_{mains}$				
Power loss at $V_{mains}$ 400 V	$P_{loss}$ [W]	100	110	140	200	260
Power derating	$\frac{[\%]}{[K]}$ $\frac{[\%]}{[m]}$	40 °C < $T_{amb}$ < 50 °C: 2%/K 1000 m a.m.s.l. ... 4000 m a.m.s.l.: 5 % / 1000m				
Dimensions	[mm]					
a		78 x	78 x	97 x	97 x	135 x
b		350 x	350 x	350 x	350 x	350 x
e		250 x	250 x	250 x	250 x	250 x
Weight	m [kg]	3.5	3.5	5.0	5.0	7.5

1) Acceleration drive operating mode

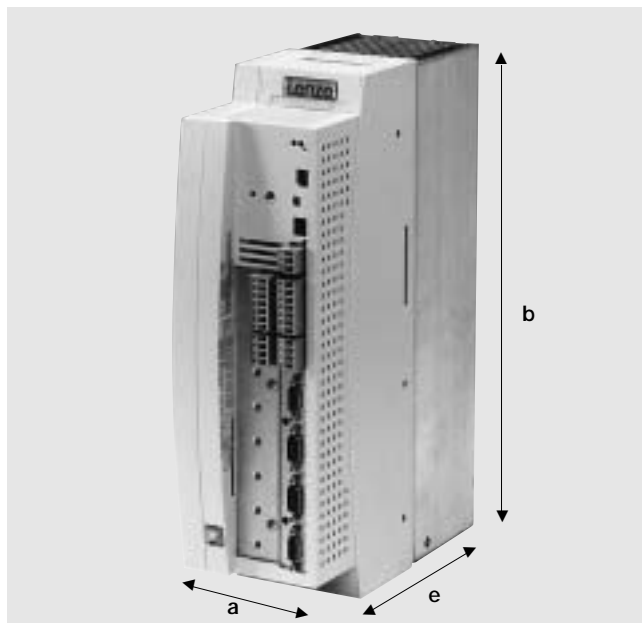

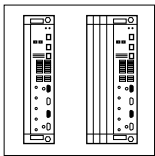

## 9300 Selection

### Ratings

Type		9326	9327	9328	9329
Servo order No.		EVS9326-ES	EVS9327-ES	EVS9328-ES	EVS9329-ES
Register control order No.		EVS9326-ER	EVS9327-ER	EVS9328-ER	EVS9329-ER
Cam disc order No.		EVS9326-EK	EVS9327-EK	EVS9328-EK	EVS9329-EK
Position controller order No.		EVS9326-EP	EVS9327-EP	EVS9328-EP	EVS9329-EP
Mains voltage	$V_r$ [V]	320 V ... 528 V $\pm$ 0 % ; 45 Hz ... 65 Hz $\pm$ 0%			
Alternative DC supply	VG [V]	460 V ... 740 V +/-0%			
<b>Ratings for operation at a mains: 3 AC / 400 V / 50 Hz / 60 Hz</b>					
Motor power (4-pole ASM)	$P_r$ [kW]	11.0	15.0	22.0	30.0
Output current at 8 kHz	$I_{r8}$ [A]	23.5	32.0	47.0	59.0
Output current at 16 kHz	$I_{r16}$ [A]	15.3	20.8	30.6	38.0
Output power	$S_r$ [kVA]	16.3	22.2	32.6	40.9
<b>Ratings for operation at a mains: 3 AC / 480 V / 50 Hz / 60 Hz</b>					
Motor power (4-pole ASM)	$P_r$ [kW]	11.0	18.5	30.0	37.0
Output current at 8 kHz	$I_{r8}$ [A]	22.3	30.4	44.7	56.0
Output current at 16 kHz	$I_{r16}$ [A]	14.5	19.2	28.2	35.0
Output power	$S_r$ [kVA]	18.5	25.0	37.0	46.6
Max. output current at 8 kHz	$I_{max}$	35.3	48.0	70.5	88.5
Max. output current at 16 kHz	$I_{max}$	22.9	31.2	45.9	57
Mains current at $V_{mains}$ 400 V	$I_r$ [A]	20.5	27.0	44.0	53.0
Motor voltage	$V_M$ [V]	3 ~ 0 ... $V_{mains}$			
Power loss at $V_{mains}$ 400 V	$P_{loss}$ [W]	360	430	640	810
Power derating	$\frac{[\%]}{[K]}$ $\frac{[\%]}{[m]}$	40 °C < $T_{amb}$ < 50 °C: 2%/K 1000 m a.m.s.l. ... 4000 m a.m.s.l.: 5 % / 1000m			
Dimensions	[mm]				
a		135 x	250 x	250 x	250 x
b		350 x	350 x	350 x	350 x
e		250	250	250	250
Weight	m [kg]	7.5	12.5	12.5	12.5

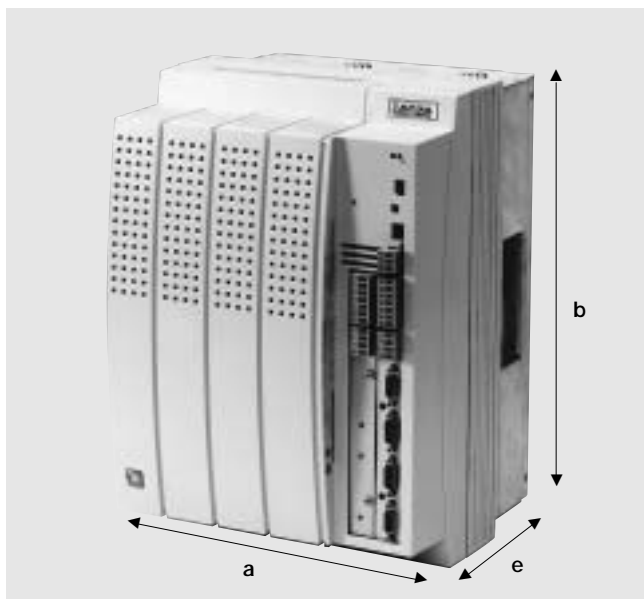

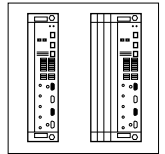

Type		9330	9331	9332
Servo order No.		EVS9330-ES	EVS9331-ES	EVS9332-ES
Register control order No.		EVS9330-ER	EVS9331-ER	EVS9332-ER
Cam disc order No.		EVS9330-EK	EVS9331-EK	EVS9332-EK
Position controller order No.		EVS9330-EP	EVS9331-EP	EVS9332-EP
Mains voltage	$V_r$ [V]	320 V ... 528 V $\pm$ 0 % ; 45 Hz ... 65 Hz $\pm$ 0%		
Alternative DC supply	VG [V]	460 V ... 740 V +/-0%		
<b>Ratings for operation at a mains: 3 AC / 400 V / 50 Hz / 60 Hz</b>				
Motor power (4-pole ASM)	$P_r$ [kW]	45.0	55.0	75.0
Output current at 8 kHz	$I_{r8}$ [A]	89.0	110.0	145.0
Output current at 16 kHz	$I_{r16}$ [A]	58.0	70.0	90.0
Output power	$S_r$ [kVA]	51.5	76.2	100.9
<b>Ratings for operation at a mains: 3 AC / 480 V / 50 Hz / 60 Hz</b>				
Motor power (4-pole ASM)	$P_r$ [kW]	45.0	55.0	90.0
Output current at 8 kHz	$I_{r8}$ [A]	84.0	105.0	125.0
Output current at 16 kHz	$I_{r16}$ [A]	55.0	65.0	80.0
Output power	$S_r$ [kVA]	69.8	87.8	104.0
Max. output current at 8 kHz	$I_{max}$	133.5	165.0	225.0
Max. output current at 16 kHz	$I_{max}$	87	105	135
Mains current at $V_{mains}$ 400 V	$I_r$ [A]	78.0	96.4	129.1
Motor voltage	$V_M$ [V]	3 ~ 0 ... $V_{mains}$		
Power loss at $V_{mains}$ 400 V	$P_{loss}$ [W]	1100	1470	1960
Power derating	$\frac{[\%]}{[K]}$ $\frac{[\%]}{[m]}$	40 °C < $T_{amb}$ < 50 °C: 2%/K 1000 m a.m.s.l. ... 4000 m a.m.s.l.: 5 % / 1000m		
Dimensions	[mm]			
a		340 x	440 x	440 x
b		591 x	680 x	680 x
e		285	285	285
Weight	m [kg]	36.5	59.0	59.0

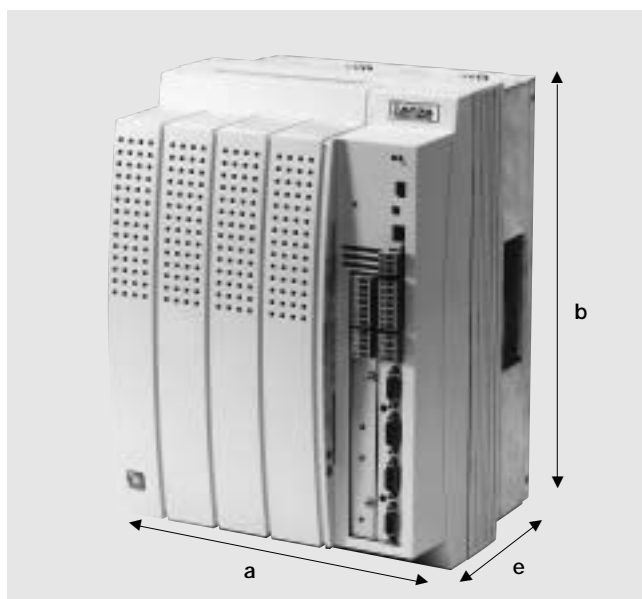



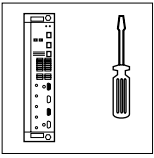

## 9300 Selection

### Mechanical installation of 9300 servos

#### General notes

- Inverters must only be used as built-in units!
- If the exhaust air contains pollutants (dust, fluff, grease, aggressive gases) ensure sufficient measures (e.g. installation of filters, periodic cleaning, etc.)
- Ensure free spaces  
When installing several inverters in one control cabinet they can be fixed side by side.  
Ensure unimpeded air circulation.  
Ensure a free space of 100 mm at top and bottom
- In the event of continuous vibrations or shocks:  
Check the application of shock absorbers.

The servo inverters of the 9300 series can be installed in a control cabinet as follows:

Using the **mounting rails** included or using **thermal separation**

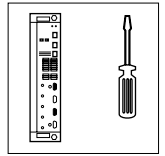

The controllers are supplied with a fixing rail which can be used to mount the servo inverter onto the rear panel of a control cabinet or onto a mounting plate. The mounting rail is fixed in a rail at the controller so that fixing brackets are available at top and bottom.

Alternatively, **thermal separation** is possible.

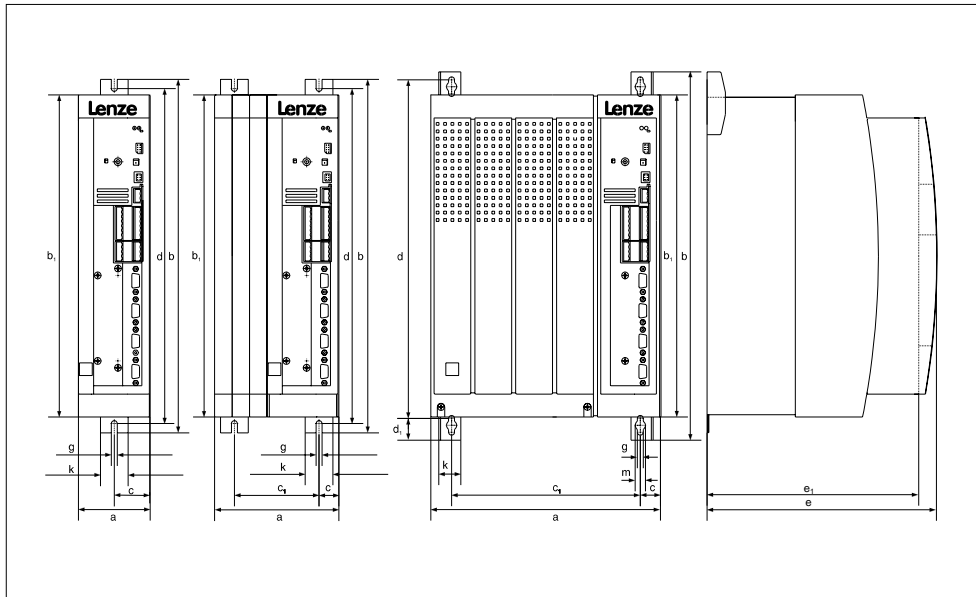

Controller	a [mm]	b [mm]	b1 [mm]	c [mm]	c1 [mm]	d [mm]	d1 [mm]	e [mm]	e1 [mm]	g [mm]	k [mm]	m [mm]
9321	78	384	350	39	-	365	-	250	230	6.5	30	-
9322	78	384	350	39	-	365	-	250	230	6.5	30	-
9323	97	384	350	48.5	-	365	-	250	230	6.5	30	-
9324	97	384	350	48.5	-	365	-	250	230	6.5	30	-
9325	135	384	350	21.5	92	365	-	250	230	6.5	30	-
9326	135	384	350	21.5	92	365	-	250	230	6.5	30	-
9327	250	402	350	22	206	370	23.5	250	230	6.5	24	11.0
9328	250	402	350	22	206	370	23.5	250	230	6.5	24	11.0
9329	250	402	350	22	206	370	23.5	250	230	6.5	24	11.0
9330	340	672	591	28.5	283	624	38	285	265	11.0	28	18.0
9331	450	748.5	680	30.5	389	702	38	285	265	11.0	28	18.0
9332	450	748.5	680	30.5	389	702	38	285	265	11.0	28	18.0

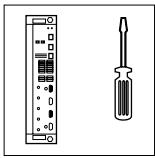

## 9300 Selection

### Installation of 9300 servo inverters with thermal separation (push-through technique)

In some applications thermal separation is required. Generation of heat within the control cabinet is thus clearly reduced.

This means that the 9300 servo inverters can be designed so that the heatsink remains outside of the control cabinet. You need a mounting frame and a seal.

- Distribution of the power loss:  
approx. 65% via separate cooler (heatsink and blower)  
approx. 35% inside the controller
  - The enclosure type of the separate cooler is IP41.
  - The ratings of the controller are still effective.
- Alternatively, the controller can be installed with the attached fixing rail.

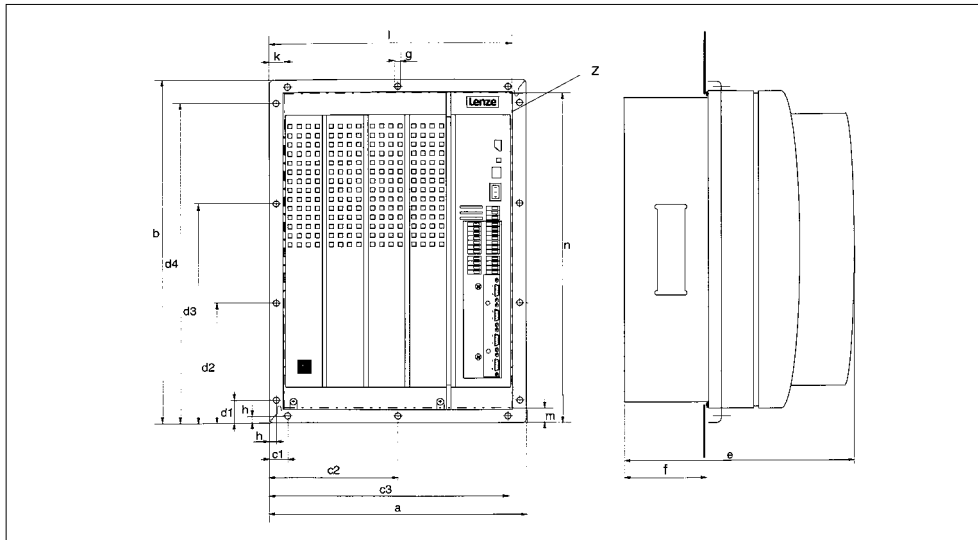

Controller	a [mm]	b [mm]	c1 [mm]	c2 [mm]	c3 [mm]	d1 [mm]	d2 [mm]	d3 [mm]	e [mm]	f [mm]	g [mm]	h [mm]
9321	112.5	385.5	26	86	-	10	115.5	164.5	250	92	6.5	9.0
9322	112.5	385.5	26	86	-	10	115.5	164.5	250	92	6.5	9.0
9323	131.5	385.5	26	105	-	10	115.5	164.5	250	92	6.5	9.0
9324	131.5	385.5	26	105	-	10	115.5	164.5	250	92	6.5	9.0
9325	169.5	385.5	26	137	-	10	115.5	164.5	250	92	6.5	9.0
9326	169.5	385.5	26	137	-	10	115.5	164.5	250	92	6.5	9.0
9327	280	379	28	140	252	41	141	1238	238	90	6.0	9.0
9328	280	379	28	140	252	41	141	1238	238	90	6.0	9.0
9329	280	379	28	140	252	41	141	1238	238	90	6.0	9.0

#### Cutout

	Height [mm]	Width [mm]	k [mm]	l [mm]	m [mm]	n [mm]
9321, 9322	350 ± 3	82 ± 3	20 ± 2	198 ± 2	20 ± 2	359 ± 2
9323, 9324	350 ± 3	101 ± 3	20 ± 2	117 ± 2	20 ± 2	359 ± 2
9325, 9326	350 ± 3	139 ± 3	20 ± 2	155 ± 2	20 ± 2	359 ± 2
9327-9329	338 ± 3	238 ± 1	20 ± 2	259 ± 2	20 ± 2	359 ± 2

\* preliminary dimensions

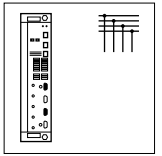

Use fuses or miniature-circuit breakers as cable protection. The following rated currents - adjusted to the corresponding

mains current of the controllers - are required by protection facilities:

Controller	Rated current of protection facility	Controller	Rated current of protection facility
9321	6 A	9327	63 A
9322	6 A	9328	63 A
9323	10 A	9329	80 A
9324	10 A	9330	100 A
9325	20 A	9331	125 A
9326	32 A	9332	160 A

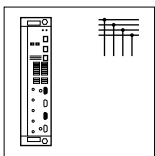

## 9300 Selection

### Cable protecting fuses

Cable protecting fuses with suitable fuse holders designated for the servos are available.

Controller	Rated current	Fuse		Required quantity	Fuse holder	
		Size	Order number		Order number	Required quantity
9321	M6A	10 x 38	EFSM-0060AWE	3	EFH10001	3
9322	M6A	10 x 38	EFSM-0060AWE	3	EFH10001	3
9323	M10A	10 x 38	EFSM-0100AWE	3	EFH10001	3
9324	M10A	10 x 38	EFSM-0100AWE	3	EFH10001	3
9325	M20A	10 x 38	EFSM-0200AWE	3	EFH10001	3
9326	M32A	14 x 51	EFSM-0320AWH	3	EFH10002	3
9327	M63A	22 x 57	EFSFF0630AYI	3	EFH30006	3
9328	M63A	22 x 57	EFSFF0630AYI	3	EFH30006	3
9329*	T80A	-	-	3	-	-
9330*	T100A	-	-	3	-	-
9331*	T125A	-	-	3	-	-
9332*	T160A	-	-	3	-	-

\* Recommendation for standard commercial fuses

### Dimensions

#### Fuse holders

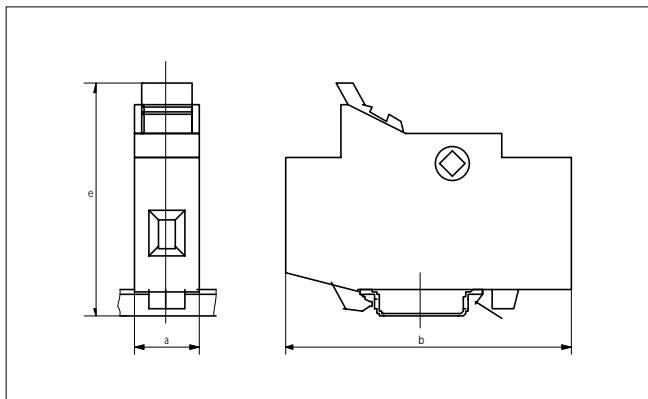

Type	a [mm]	b [mm]	e [mm]	Dimensions of the fuse
EFH10001	17.5	81	68	10 x 38
EFH10002	26	81	68	14 x 51
EFH30006	35	123	83	22 x 57



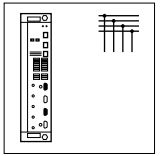

Automatic circuit breakers up to a mains current of 32 A designated for the servos are available.

Controller	Automatic circuit breakers		
	Rated current	Order number	Required quantity
9321	B 6 A	EFA3-B06A	1
9322	B 6 A	EFA3-B06A	1
9323	B 10A	EFA3-B10A	1
9324	B 10A	EFA3-B10A	1
9325	B 20A	EFA3-B20A	1
9326	B 32A	EFA3-B32A	1

### Dimensions

Automatic circuit breakers

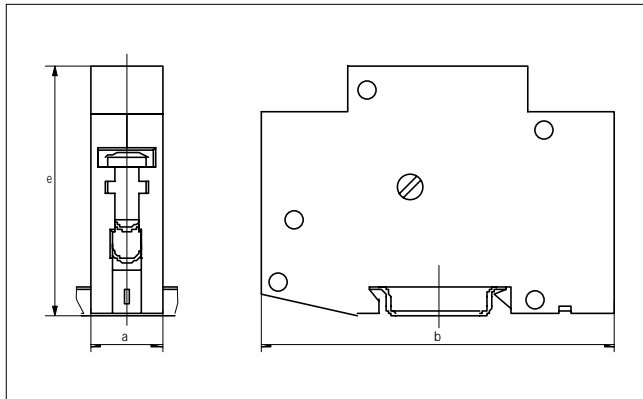

Type	a [mm]	b [mm]	e [mm]
EFA1CXXXA	17.5	80	63
EFA3BXXXA	53	90	63

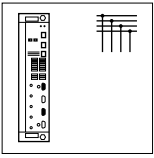

## 9300 Selection

### CE-typical installation

#### General notes

- The electromagnetic compatibility of a machine depends on the kind of installation, and the care taken.

Therefore, take special care for:

- assembly
- filters
- screens
- grounding

For wiring, see the connection diagram of the power stage.

#### Installation notes

If you observe the following measures you can be sure that the drive system will not cause any EMC problems when running the machine.

- Assembly
  - Connect as large a surface as possible of the inverter and mains filter to the grounded mounting plate:
    - Mounting plates with conductive surfaces (zinc-coated) allow a permanent contact.
    - If the mounting plates are painted, the paint must be removed.
  - When using several mounting plates:
    - Connect as large a surface as possible to the mounting plates (e. g. with copper bands)
- Ensure the separation of motor cable from signal and mains cables.
- Do not use the same terminal strip for mains input and motor output.
- Route the cable as close as possible to the reference potential. Loose cables have the same effects as aerials.

#### Filters

- Only use mains filters or RFI filters and mains chokes suitable for the inverters:
  - RFI filters reduce impermissible high-frequency disturbance to a permissible value.
  - Mains chokes reduce the r.m.s. current consumption of the inverter from the mains, which is especially caused by motor cables and are dependant on their lengths.
  - Mains filters combine the functions of mains choke and RFI filter.

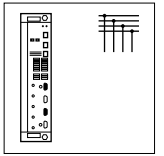

### Screens

- Connect the screen of the motor to the screen connection of the drive controller (93xxE).
- If contactors, motor-protections switches, or terminals are located in the motor cable:
  - Also connect the screens of the connected cables to the mounting plate, with a surface as large as possible.
- Connect the screen in the terminal box to PE:
  - Metal cable glands at the motor-terminal box ensure a connection of the screen to the motor housing with a surface as large as possible.
- If the mains cable between mains filter and inverter is longer than 300 mm:
  - Screen mains cable.
  - Connect the screen of the mains cable directly to the inverter and to the mains filter and connect it to the mounting plate with a surface as large as possible.
- When using a brake chopper:
  - Connect the screen of the brake-resistor cable directly to the mounting plate at the brake chopper and the brake resistor with a surface as large as possible.
  - Connect the screen of the cable between inverter and brake chopper directly to the mounting plate at the inverter and the brake chopper with a surface as large as possible.
- When operating the inverters in DC-bus connection:
  - Screen the cables between the inverters (+VG/-VG) and the DC-bus bar star point.
  - Connect both screen ends to the mounting plate with a surface as large as possible.

- Screen the control cables:
  - Connect both screen ends of digital control cables.
  - Connect one screen end of analog control cables.
  - Connect the screens of the control cables to the screen connections provided at the inverter over the shortest possible distance.
- When using 93xxE inverters in residential areas:
  - To limit the emission in residential areas, an additional screening of  $\approx 10$  dB is required. This is usually achieved by installation in enclosed and grounded control cabinets made of metal.

### Grounding

- Ground all components (inverter, mains filter, motor filter, mains chokes) using suitable cables connected to a central grounding point (PE bar).
- Maintain the minimum cross-sections prescribed in the safety regulations:
  - For EMC, not the cable cross section is important but the surface and the contact with a cross-section as large as possible, i.e. large surface.

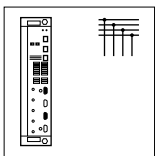

## 9300 Selection

### Mains filter A for 9300 servo inverter

Depending on the area of application, different measures to reduce the mains current and RFI are necessary at the mains side.

Normally, these measures are not compulsory, but they ensure the universal application of a servo inverter. Mains filters reduce EMC interference and mains currents of the controller. Two limit value classes of EMC interference are distinguished.

Limit value class A is often required for industrial mains, which are separated from mains in residential areas. The noise emission of the connected consumer must not exceed the defined characteristic. Limit value class B is valid for residential areas.

Connect a mains filter A to the servo inverter to comply with limit value class A.

#### Technical data

Controller	Mains filter A				
	Order number	$I_r$ [A]	$V_{\text{mains}}$ [V]	Inductance [mH]	m [kg]
9321	EZN3A2400H002	1.5	400...480	24.0	0.8
9322	EZN3A1500H003	2.5	400...480	15.0	1.15
9323	EZN3A0900H004	4.0	400...480	9.0	1.55
9324	EZN3A0500H007	7.0	400...480	5.0	2.55
9325	EZN3A0300H013	13.0	400...480	3.0	5.2
9326	EZN3A0150H024	24.0	400...480	1.5	8.2
9327	EZN3A0110H030	30.0	400...480	1.1	16.0
9328	EZN3A0080H042	42.0	400...480	0.80	17.0
9329	EZN3A0055H060	60.0	400...480	0.55	30.0
9330	EZN3A0037H090	90.0	400...480	0.37	40.0
9331	EZN3A0022H150	150.0	400...480	0.22	60.0
9332	EZN3A0022H150	150.0	400...480	0.22	60.0

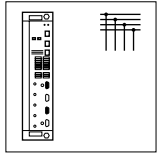

## Mains filter A for 9300 servo inverter

### Dimensions of mains filters A

Order number	Figure	a [mm]	b [mm]	c [mm]	d [mm]	e [mm]	m [mm]	n [mm]
EZN3A2400H002	A	77	71	50	38	98	5	9
EZN3A1500H003	A	95	82	56	35	115	5	9
EZN3A0900H004	A	95	90	56	43	116	5	9
EZN3A0500H007	A	119	95	90	49	138	5	9
EZN3A0300H013	A	150	106	113	64	162	6	11
EZN3A0150H024	A	180	120	136	67	192	7	12

### Dimensions of mains filters A, for connection to the servo inverter

Order number	Figure	a	b	b <sub>1</sub>	c	d	d <sub>1</sub>	d <sub>2</sub>	d <sub>3</sub>	d <sub>4</sub>	e	m	n		
EZN3A0110H030	B	278	710	365	258	670	22	300	38	300	250	11	6.5		
285															
285															
EZN3A0037H090	B	368	1015	516	345	964	38	4421	38	335	285	18	11		
		a	a <sub>1</sub>	b	b <sub>1</sub>	c	d	d <sub>1</sub>	d <sub>2</sub>	d <sub>3</sub>	e	f	g	k	m
EZN3A0022H150	C	500	478	800	680	455	750	38	372	328	470	1000	11	28	18

Figure A

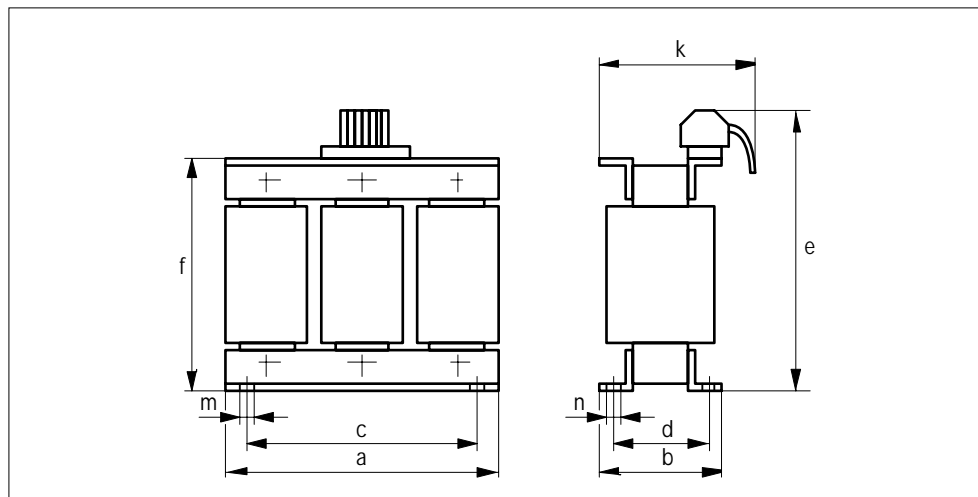

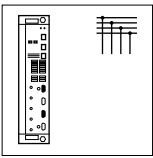

# 9300 Selection

## Mains filter A for 9300 servo inverters

Figure B

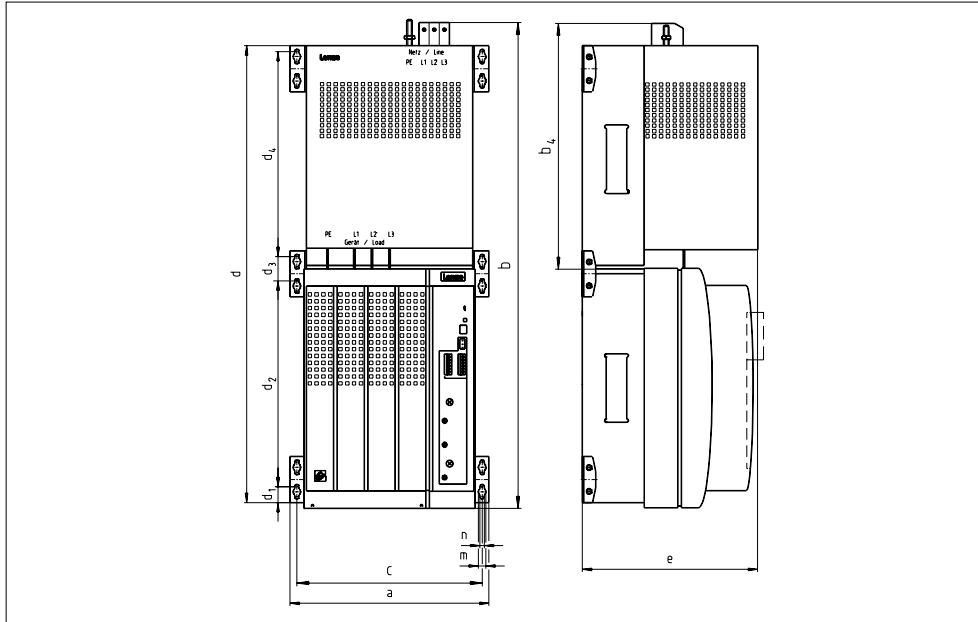
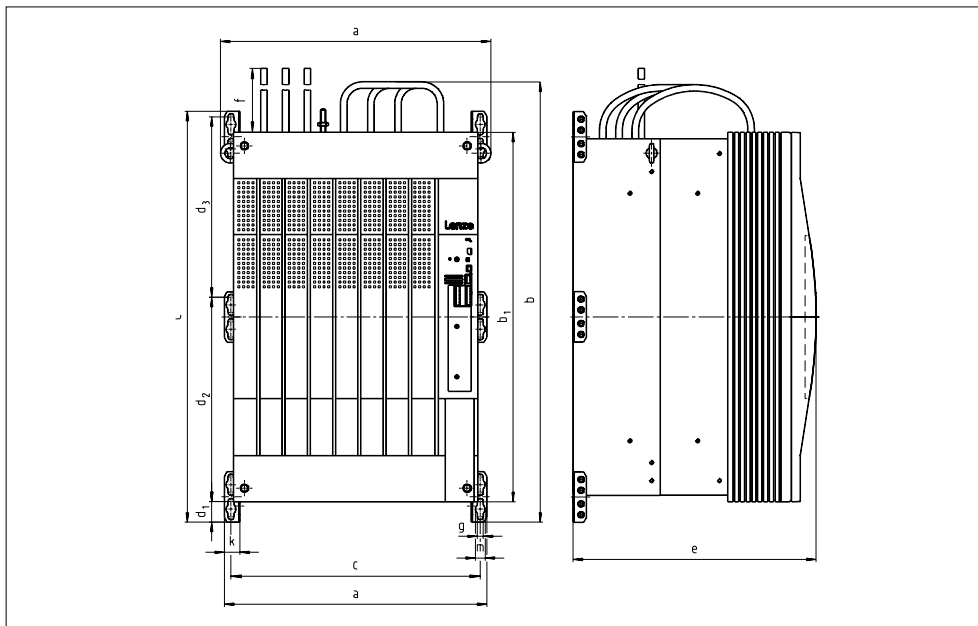
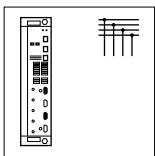

Figure C



The filter is equipped with a matching connecting cable and, therefore, must be directly mounted onto the servo.





## 9300 Selection

### Mains filter B for 9300 servos

Depending on the area of application, different measures to reduce the mains current and RFI are necessary at the mains side.

Normally, these measures are not compulsory, but they ensure the universal application of a servo inverter.

Mains filters reduce EMC interference and mains currents of the controller. Two limit value classes of EMC interference are distinguished.

When the servo inverter is not operated in an industrial mains, but in a residential area, other devices such as radios and TV sets can be interfered. Here, RFI suppression measures according to EN 55011, limit value class B, are necessary.

Limit value class B is clearly lower than limit value class A. Limit value class A is valid for industrial mains.

Connect a mains filter B to the servo inverter to comply with limit value class B.

Figure 1 shows such a filter.

#### Technical data

Controller	Mains filter B				
	Order number	$I_r$ [A]	$V_{\text{mains}}$ [V]	Inductance [mH]	m [kg]
9321	EZN3B2400H002	1.5	400...480	24.0	0.8
9322	EZN3B1500H003	2.5	400...480	15.0	1.15
9323	EZN3B0900H004	4.0	400...480	9.0	1.55
9324	EZN3B0500H007	7.0	400...480	5.0	2.55
9325	EZN3B0300H013	13.0	400...480	3.0	5.2
9326	EZN3B0150H024	24.0	400...480	1.5	8.2
9327	EZN3B0110H030	30.0	400...480	1.1	16.0
9328	EZN3B0080H042	42.0	400...480	0.80	17.0
9329	EZN3B0055H060	60.0	400...480	0.55	30.0
9330	EZN3B0037H090	90.0	400...480	0.37	40.0
9331	EZN3B0022H150	150.0	400...480	0.22	60.0
9332	EZN3B0022H150	150.0	400...480	0.22	60.0





## Mains filters B for 9300 servos

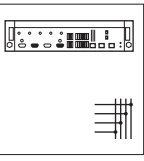

### Dimensions of mains filters B

Order number	Figure	a [mm]	b [mm]	c [mm]	d [mm]	e [mm]	m [mm]
EZN3A2400H002	A	78	150	-	135	230	7
EZN3A1500H003	A	78	150	-	135	230	7
EZN3A0900H004	A	97	180	-	165	230	7
EZN3A0500H007	A	97	180	-	165	230	7
EZN3A0300H013	A	135	260	92	245	230	7
EZN3A0150H024	A	135	260	92	245	230	7

### Dimensions of mains filters B, for connection to servos

Order number	Figure	a	b	b <sub>1</sub>	c	d	d <sub>1</sub>	d <sub>2</sub>	d <sub>3</sub>	d <sub>4</sub>	e	m	n		
EZN3B0110H030	B	278	710	365	258	670	22	300	38	300	250	11	6.5		
EZN3B0080H042															
EZN3B0055H060															
EZN3B0037H090	B	368	1015	516	345	964	38	4421	38	335	285	18	11		
EZN3B0022H150	C	a	a <sub>1</sub>	b	b <sub>1</sub>	c	d	d <sub>1</sub>	d <sub>2</sub>	d <sub>3</sub>	e	f	g	k	m
		500	478	800	680	455	750	38	372	328	470	1000	11	28	18

Figure A

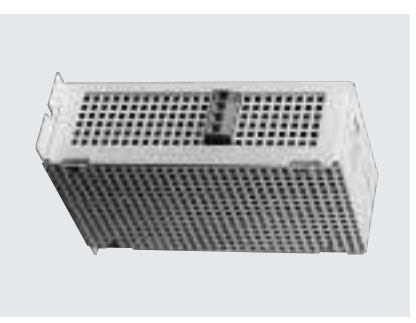
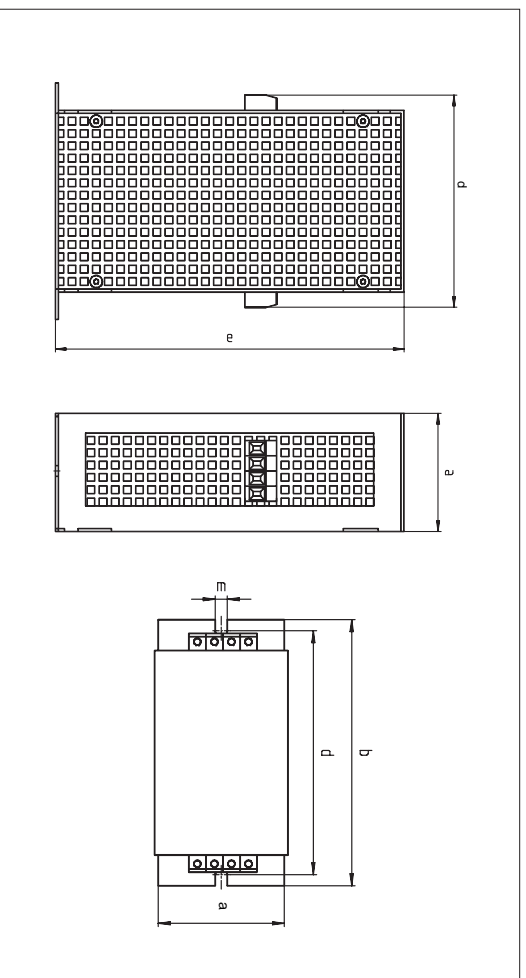

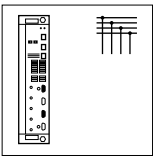

# 9300 Selection

## Mains filters B for 9300 servos

Figure B

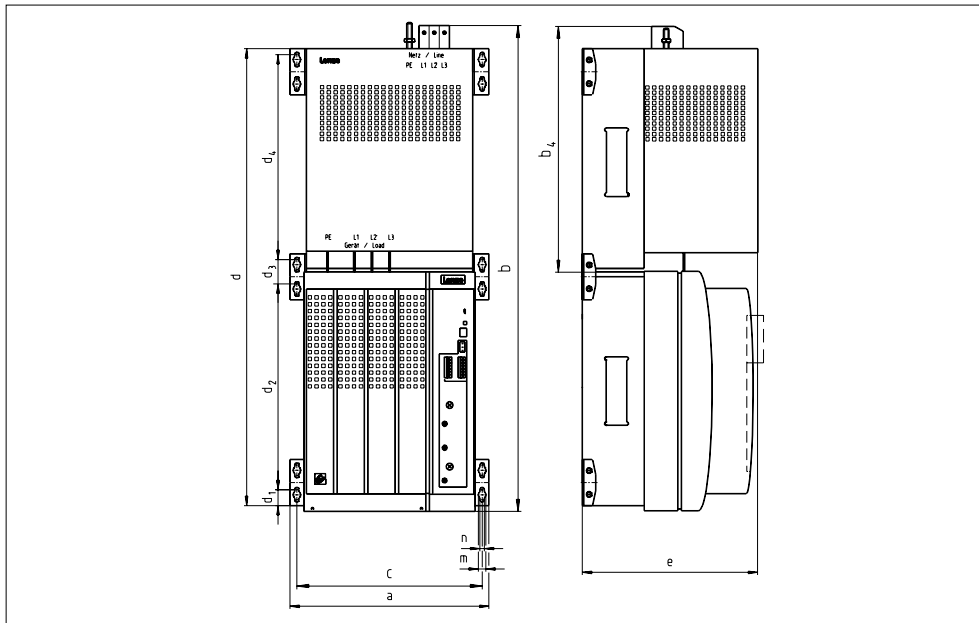
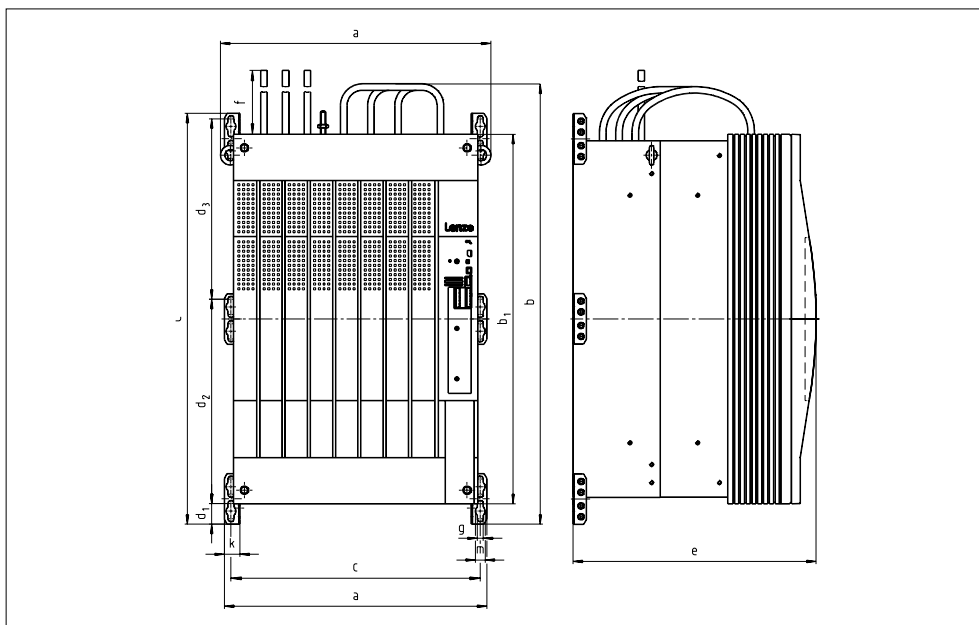
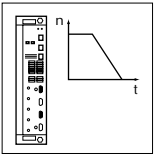

Figure C



The filter is equipped with matching connecting cable and, therefore, must be directly mounted onto the servo inverter.





## 9300 Selection

### Braking operation with 9300 servos

#### Options

##### Braking operation with brake unit

If a motor is braked by the servo inverter over a short time, the motor operates in the generator mode and feeds back energy to the servo inverter. The DC-bus voltage of the servo inverter rises. If the voltage becomes too high, the servo inverter inhibits the power stages and the motor coasts to standstill. By using a brake unit which consists of a brake module with integrated resistor or a brake chopper with external resistor, the regenerative energy is led to the brake resistor and dissipated as heat. The drive can be decelerated in a controlled way.

##### Regenerative operation

Particularly for multi-axis and DC bus connections, a regenerative power supply module can be alternatively used. These components contribute to save energy and costs.

##### Selection of brake resistors

The brake resistors are selected according to the continuous power loss and the energy to be braked. The rated power of the brake resistors is calculated as follows:

$$P_r = \frac{t_{br}}{t_{cyc}} \times P_{max} ; P_{max} = \frac{1}{2} \frac{W_{kin}}{t_{br}}$$

The maximum kinetic energy to be dissipated results from the peak brake power and the maximum duty time of the brake chopper.

$$W_{max} = P_{max} \cdot t_{0max}$$

$P_{max}$ : Brake power during braking

$t_{br}$ : Braking time

$t_{cyc}$ : Time between two brake cycles

$W_{kin}$ : Kinetic energy to be braked

$t_{0max}$ : Maximum duty time of the brake chopper

Since the frequency change is also led through the set-point integrator of the inverter during braking, the value "Tif" set at the inverter can be used as brake time  $t_{br}$ .

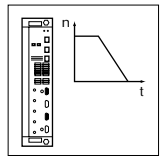

The 9351 brake module already integrates a brake resistor. This brake resistor has a resistance of 47 Ohm. The maximum peak brake power is 12 kW with a duty time cycle of 1 % per 4 seconds.

Depending on the brake power required, the brake module can be used with all controllers of the 9300 series. If a higher brake power is required, the 9352 brake chopper with a matched external brake resistor can be selected.

### Technical data of 9351 brake module

Supply voltage	270 ... 780 V		
Threshold at 400 V	725 V DC	Max. brake energy	50 kWS
Threshold at 460 V	725 V DC	Min. brake resistance	47 Ohm internal
Threshold at 480 V	765 V DC		
Max. current	16 A DC	Ambient temperature	0 ... 40 °C
Continuous brake power	100 W	Storage temperature	-20 ... 70 °C
Peak brake power	12 kW at 1 % max. duty time of 4 s	Humidity	Humidity class F

### Dimensions

Controller	Order number	a [mm]	b [mm]	b1 [mm]	c [mm]	d [mm]	e [mm]	g [mm]	k [mm]	m [mm]
EMB9351-E	EMB9351-E	52	384	350	26	365	186	6.5	30	2.6

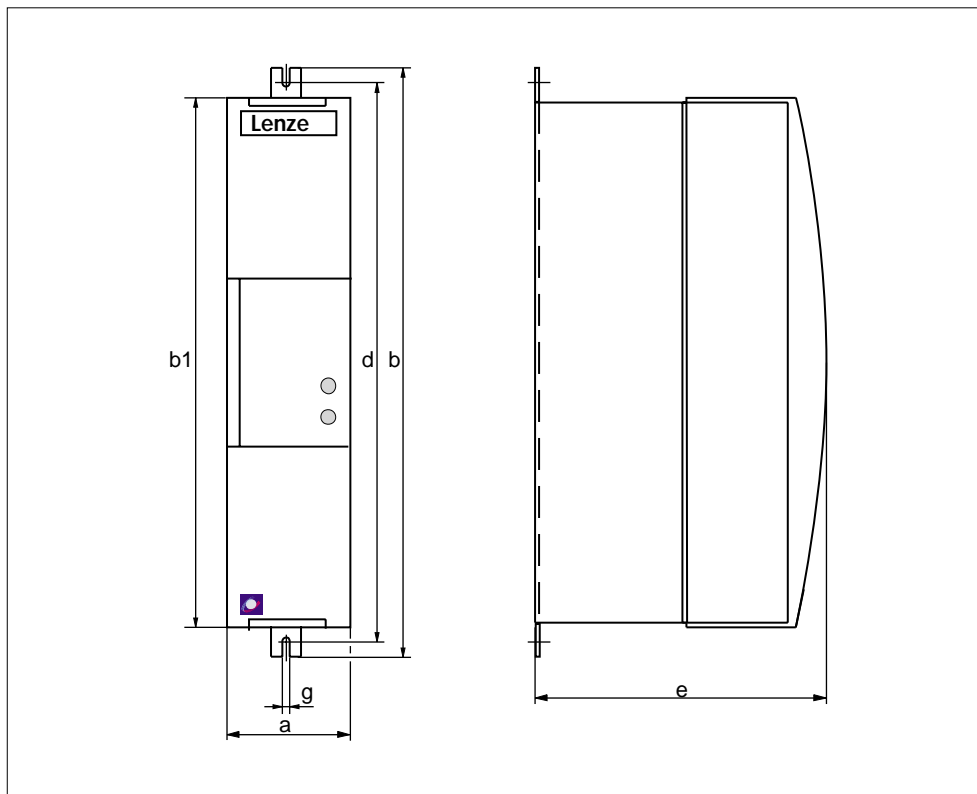

The brake module can also be installed with thermal separation - just like the servo inverters.

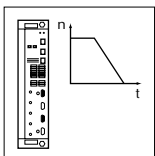

## 9300 Selection

### 9352 brake chopper

The 9352 brake chopper offers an optimum adaptation to the required brake power, because this brake chopper is operated with an external brake resistor. The minimum brake resistance is 18 Ohm.

The brake chopper can be placed directly next to the 9300 servo.

If a smaller brake power is required, the 9351 brake module with an integrated brake resistor can be used.

#### Technical data of 9352 brake chopper

Supply voltage	270 ... 780 V		
Threshold at 400 V AC	725 V DC	Max. brake energy	Depending on the brake resistor
Threshold at 460 V AC	725 V DC	Min. brake resistance	18 Ohm
Threshold at 480 V AC	765 V DC		
Max. current	42 A DC	Ambient temperature	0 ... 40 °C
Continuous brake power	19 kW	Storage temperature	-20 ... 70 °C
Peak brake power	32 kW 50 % at max. duty time of 60s	Humidity	Humidity class F

#### Combination of brake resistor and brake chopper for the 9300 servo inverters

Unit	Brake chopper		Brake resistor					
	Order no.	Lowest resistance [Ohm]	Order no.	Resistance [Ohm]	Peak-power [kW]	Continuous power [W]	Thermal capacitance [kWs]	m [kg]
9321	EMB9352-E	18	ERBD180R300W	180	3.0	300	45.0	2.0
9322	EMB9352-E	18	ERBD180R300W	180	3.0	300	45.0	2.0
9323	EMB9352-E	18	ERBD082R600W	82	6.0	600	90.0	3.1
9324	EMB9352-E	18	ERBD068R800W	68	8.0	800	120.0	4.3
9325	EMB9352-E	18	ERBD047R01k2	47	12.0	1200	180.0	4.9
9326	EMB9352-E	18	ERBD047R01k2	47	12.0	1200	180.0	4.9
9327	EMB9352-E	18	ERBD033R01k2	33	17.0	2000	300	7.1
9328	EMB9352-E	18	ERBD022R03k0	22	26.0	3000	450	10.6
9329	EMB9352-E	18	ERBD018R03k0	18	32.5	3000	450	10.6
9330 2 x	EMB9352-E	18	ERBD022R03k0	22	26.0	3000	450	10.6
9331 2 x	EMB9352-E	18	ERBD022R03k0	22	26.0	3000	450	10.6
9332 3 x	EMB9352-E	18	ERBD022R03k0	22	26.0	3000	450	10.6

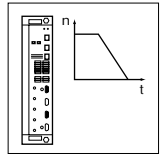

Dimensions of brake chopper

Controller	Order number	a [mm]	b [mm]	b1 [mm]	c [mm]	d [mm]	e [mm]	g [mm]	k [mm]	m [mm]
9352	EMB9352-E	52	384	350	26	365	186	6.5	30	2.2

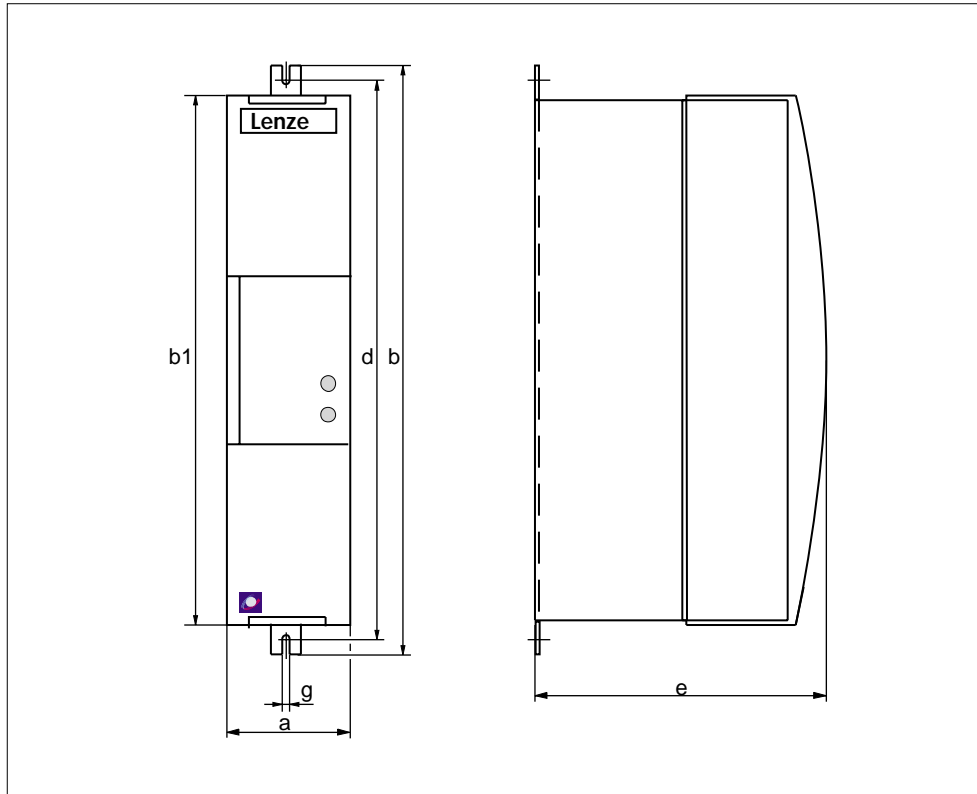

The brake chopper can also be installed with thermal separation - just like the servos.

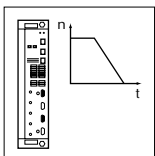

## 9300 Selection

9352 brake resistors for 9300 servos

### Dimensions of brake resistors with grid

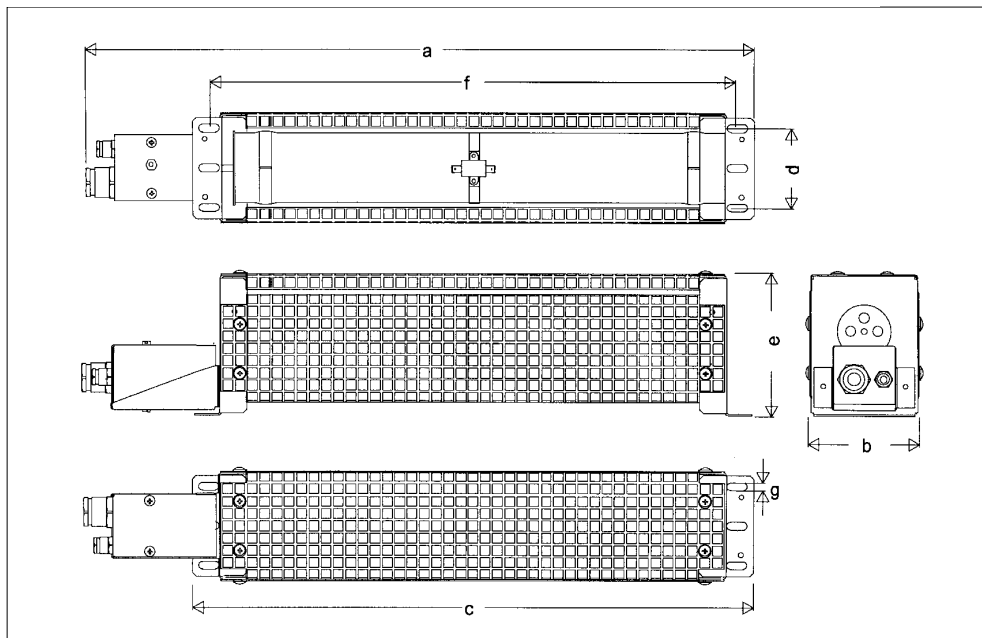

Brake resistor Order No.	a [mm]	b [mm]	c [mm]	d [mm]	e [mm]	f [mm]	g [mm]	h [mm]
ERBD180R300W	440	89	354	64	115	326	6.5	13
ERBD082R600W	640	89	554	64	115	526	6.5	13
ERBD068R800W	540	177	454	150	115	526	6.5	13
ERBD047R01k2	640	177	554	150	115	526	6.5	13
ERBD033R02k0	640	265	654	240	115	526	6.5	13
ERBD022R03k0	740	177	654	150	229	626	6.5	13
ERBD018R03k0	740	177	654	150	229	626	6.5	13



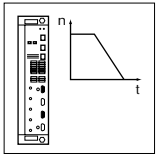

### Brake units

- Please observe:
    - The assignments in the table allow a maximum brake time of 15 seconds
    - Relative duty time of 10 %.
  - The assignment refers to the set controller continuous power.
- You can achieve a higher brake power by other resistors or by connecting several resistors in parallel or in series. Do not fall below the smallest value indicated!
  - All brake resistors indicated have an integrated temperature monitoring.
  - Parallel connection of brake choppers for higher brake power.

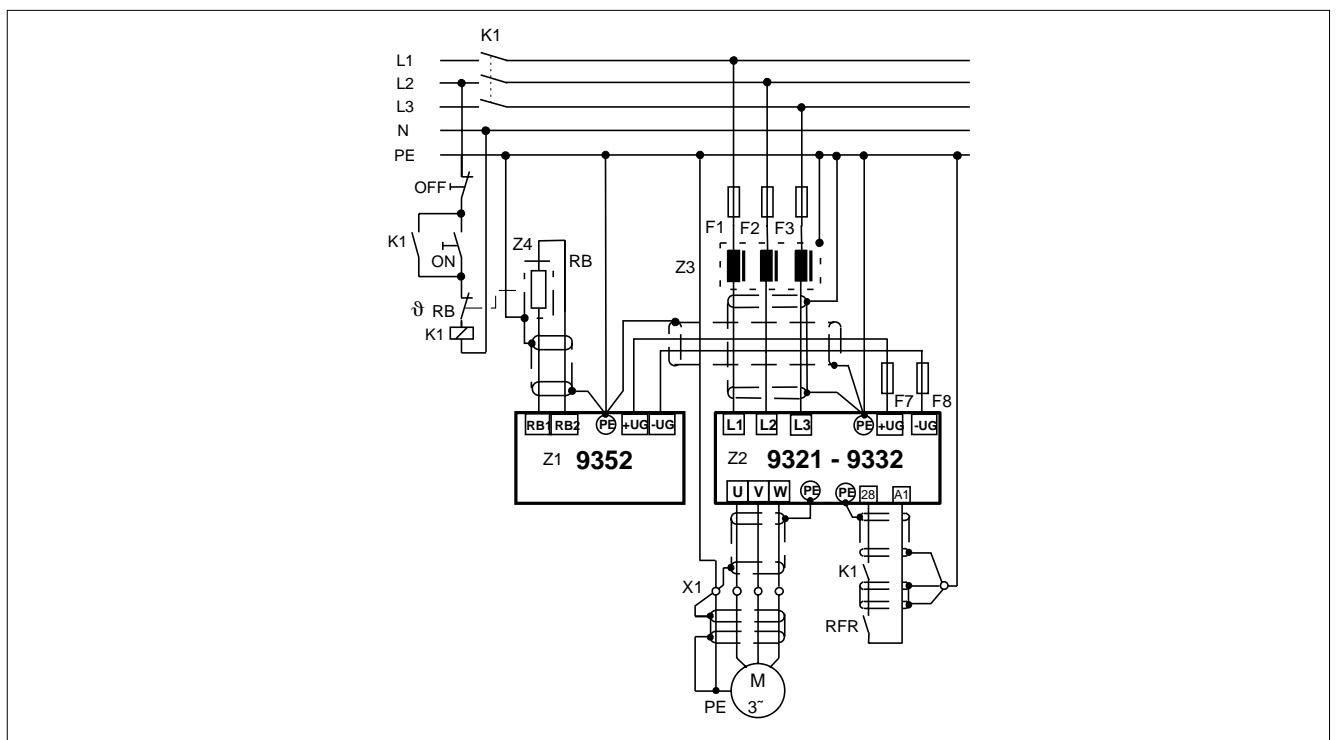
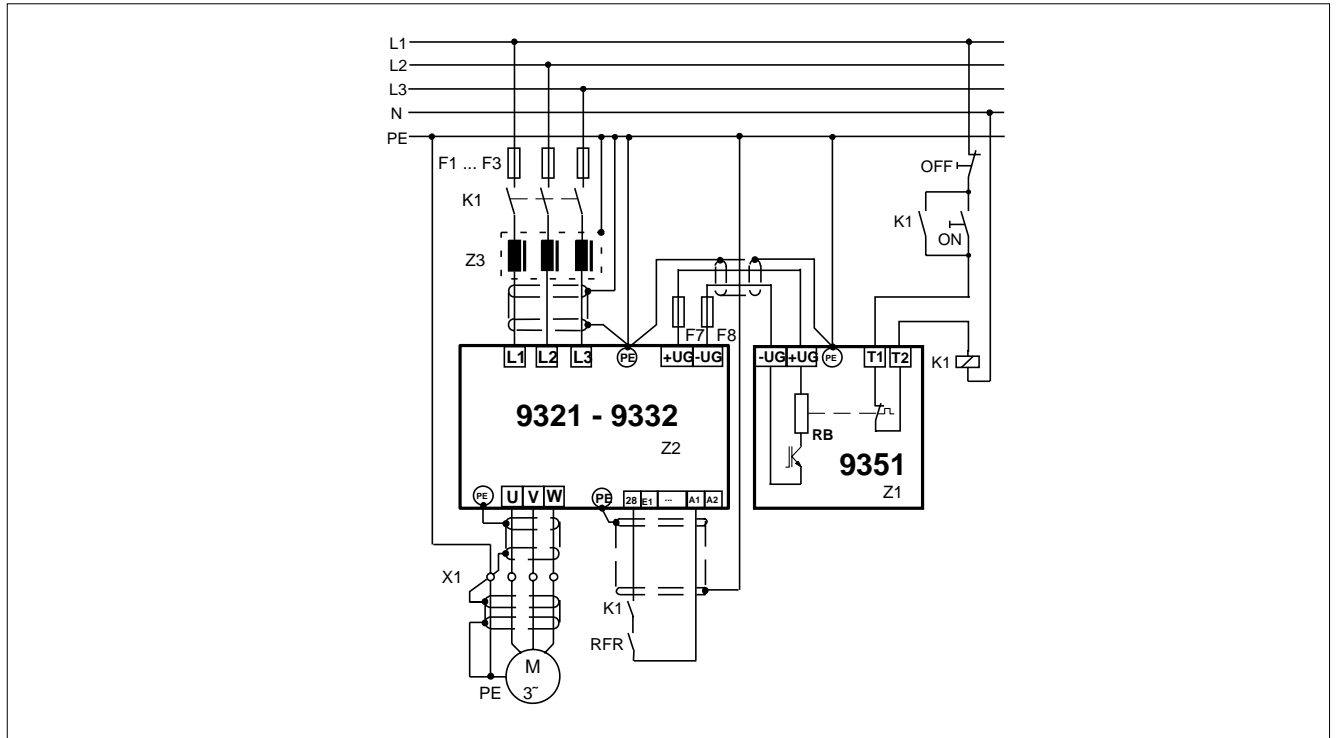

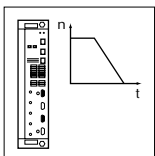

## 9300 Selection

### Regenerative power supply modules for 9300 servos

The 9340 regenerative power supply modules offer advantages, especially for multi-axis connections and DC bus connections. These controllers are space-saving and have an IP20 enclosure. Thanks to the universal system of the 9300 series these additional components can be connected directly next to the 9300 servo inverters. The supply and regenerative modules feed the brake regenerative power supply energy back into the mains.

The dissipation of the brake energy does not present a problem. For mains connections you can use mains filters and for DC bus connection DC bus fuses.

The 9351 brake module or the 9352 brake chopper are an alternative to regenerative power supply module. The brake energy in these modules is dissipated as heat.

#### General data of the supply and regenerative modules

Humidity	Humidity class F without condensation (relative humidity 85% without condensation)
Transport temperature	-25 ... 70 °C
Storage temperature	25 ... 55 °C
Operating temperature	0 ... 40 °C / 40 ... 50 °C with power derating 2.0 % per K
Noise immunity	IEC801-2 to 5 severity 4
Degree of pollution	VDE 110 part 2 degree of pollution 2
Dielectric strength	VDE 0110 surge strength class III
Packaging	according to DIN 4180
Enclosure	IP 20 IP 42 on the heatsink side with thermal separation in push-through technique NEMA 1
Approval	CE conformity and UL approval
Air pressure	100 % rated current at 900 mbar (approx. 1000m a.m.s.l.) according to VDE 875 part 11 and pr EN 55082

#### Ratings

Type	9341	9342	9343
Mains voltage	320 ... 528 V ± 0 %		
Mains frequency	48 ... 62 Hz ± 0 %		
Output power [kVA]	7.8	15.6	29.6
Rated mains current [A]	12.0	24.0	45.0
Max. mains current [A]	18.0	36.0	72.0
Power loss [W]	100	200	400
Power derating	2 % / °C, 5 % / 1000 m		

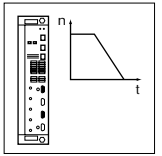

### Dimensions

Controller	a [mm]	b [mm]	b1 [mm]	c [mm]	c1 [mm]	d [mm]	d1 [mm]	e [mm]	e1 [mm]	g [mm]	k [mm]	m [kg]
9341	135	384	350	21,5	92	365	-	230	250	6.5	30	7.5
9342	135	384	350	21.5	92	365	-	230	250	6.5	30	7.5
9343	250	404	350	14	205	396	24	230	250	6.5	25	12.5

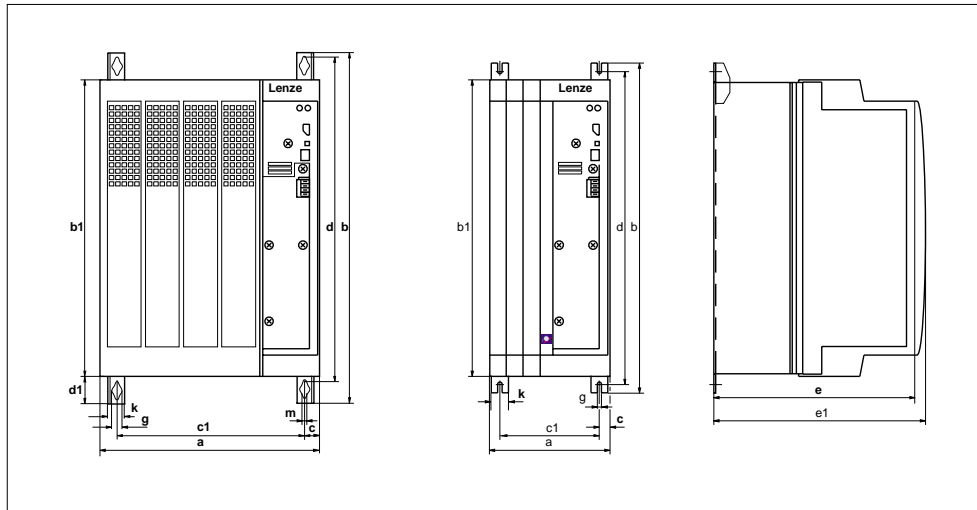

The regenerative power supply module can also be installed with thermal separation - just like the servo.

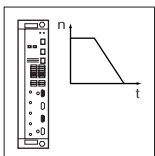

## 9300 Selection

### Regenerative power supply modules for 9300 servos

#### Mains filter for 9340 regenerative power supply modules

Depending on the field of application, different measures to reduce the mains current and RFI are necessary at the mains side.

Normally, these measures are not compulsory, but they ensure the universal application of a servo inverter. Mains filters reduce EMC interference and mains currents of the controller.

Two limit value classes of EMC interference are distinguished. Limit value class A is often required for industrial mains, which are separated from mains in residential areas. The noise emission of the connected consumer must not exceed the defined characteristic. Connect a mains filter A to the servo inverter to comply with limit value class A.

#### Technical data

Controller	Mains filter A				
	Order number	$I_r$ [A]	$V_{\text{mains}}$ [V]	Inductance [mH]	m [kg]
9341	EZN3A0120H012	12.0	480	1.20	4.7
9342	EZN3A0088H024	24.0	480	0.88	12.2
9343	EZN3A0055H045	45.0	480	0.55	15.0

#### Dimensions of mains filter A

Order number	Figure	a [mm]	b [mm]	c [mm]	d [mm]	e [mm]	m [mm]	n [mm]					
EZN3A0120H012	A	135	260	135	245	230	7.0	-					
EZN3A0088H024	A	135	380	135	365	230	7.0	-					
EZN3A0055H045	B	a	b	b <sub>1</sub>	c	d	d <sub>1</sub>	d <sub>2</sub>	d <sub>3</sub>	d <sub>4</sub>	e	m	n
		278	710	365	258	670	22	300	38	300	250	11	6.5

Figure A

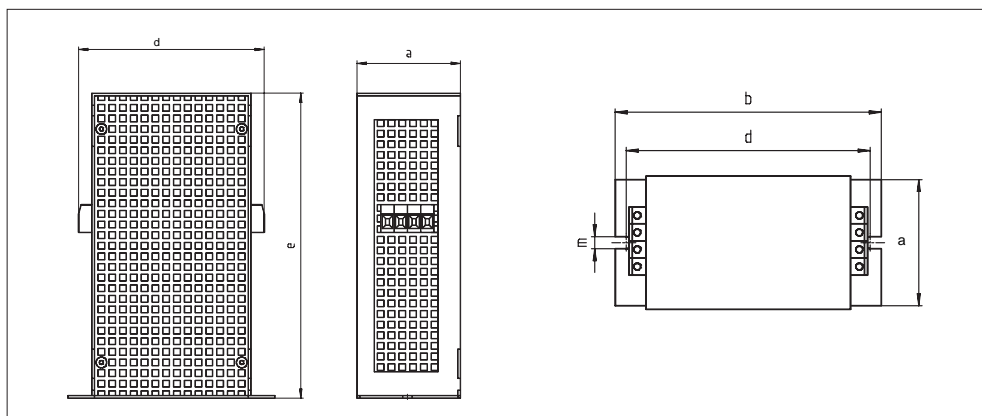
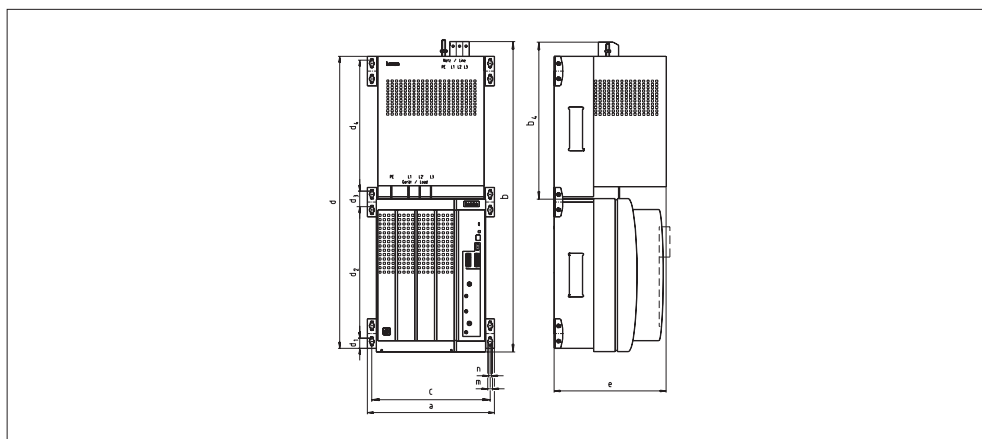
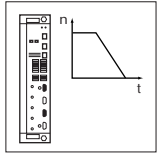

Figure B





### DC-bus fuses

Controller	Fuse				Fuse holder	
	Rated current [A]	Size	Order number	Required quantity	Order number	Required quantity
9341	16	27 x 60	EFSCC0160AYJ	2	EFH20004	1
9342	32	27 x 60	EFSCC0320AYJ	2	EFH20004	1
9343	70	27 x 60	EFSCC0800AYJ	2	EFH20004	1

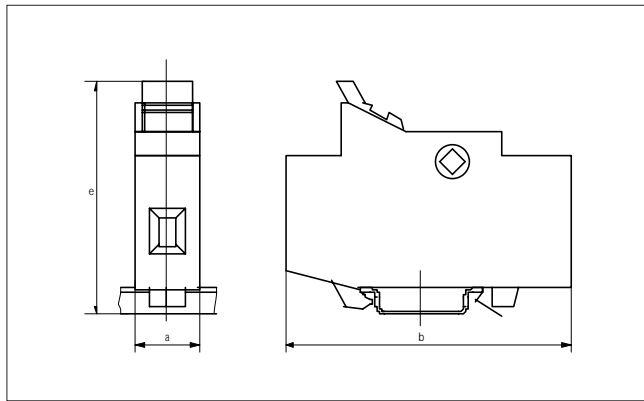

### Dimensions of fuse holders

Type	a [mm]	b [mm]	e [mm]
EFH20004	77.0	150.0	107.0

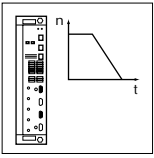

## 9300 Selection

### DC-bus connection with 9300 servos

#### DC-bus fuses for DC-bus connection

DC-bus fuses with suitable holders are assigned to the individual frequency inverters for DC-bus connection.

Controller	Fuse				Fuse holder	
	Rated current [A]	Size	Order number	Required quantity	Order-number	Required quantity
9321	CC 6.0	27 x 60	EFSCC0060AYJ	2	EFH20004	1
9322	CC 6.0	27 x 60	EFSCC0060AYJ	2	EFH20004	1
9323	CC 8.0	27 x 60	EFSCC0080AYJ	2	EFH20004	1
9324	CC 12.0	27 x 60	EFSCC0120AYJ	2	EFH20004	1
9325	CC 16.0	27 x 60	EFSCC0160AYJ	2	EFH20004	1
9326	CC 40.0	27 x 60	EFSCC0400AYJ	2	EFH20004	1
9327	CC 50.0	27 x 60	EFSCC0500AYJ	2	EFH20004	1
9328	CC 80.0	27 x 60	EFSCC0800AYJ	2	EFH20004	1
9329	CC 100.0	27 x 60	EFSCC1000AYJ	2	EFH20004	1
9330	CC 80.0	27 x 60	EFSCC0800AYJ	4 *	EFH20004	2 *
9331	CC 100.0	27 x 60	EFSCC1000AYJ	4 *	EFH20004	2 *
9332	CC 80.0	27 x 60	EFSCC0800AYJ	6 *	EFH20004	3 *

\* parallel

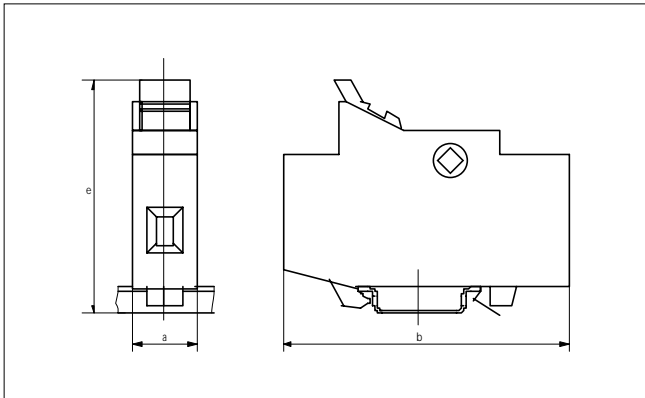

#### Dimensions of fuse holders

Type	a [mm]	b [mm]	e [mm]
EFH20004	77.0	150.0	107.0

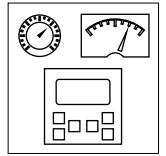

### The key to the 9300 servo

- Parameter setting:  
The factory settings of the 9300 servo (menus) correspond to the most common applications. To adapt your drive to your requirements you can modify easily and conveniently all parameters of the servo using the operation module to be attached at the front side.
- Transfer of parameter sets:  
The integrated, non-volatile memory enables - even when no voltage is applied the temporary storing of a parameter set in the operation module.
- Drive control:  
The drive can be controlled via the keypad of the operation module.
- Display of fault and status messages:  
Your drive can be monitored easily and fast by the LCD display.

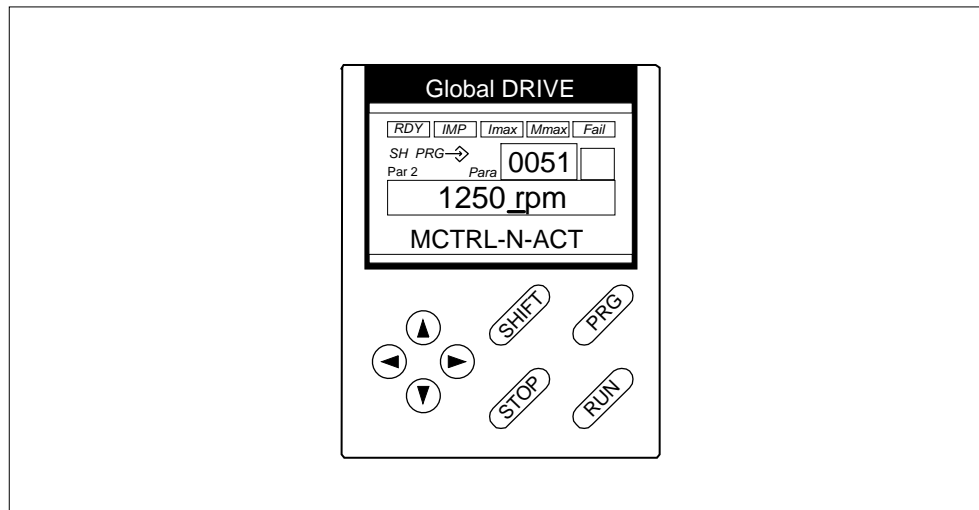

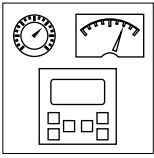

## 9300 Selection

### System bus converter

#### 9372BB hand terminal

The EMZ 9372BB hand terminal can be used for display and error diagnosis. This hand terminal can be connected to the system bus of the servo inverter.

All parameters can be accessed.

In networked systems up to 63 servo inverters can be addressed by one hand terminal.



#### 2173IB PC/System bus converter

Using the PC/System bus converter, the parameters of the 9300 servo can be set. By means of this tool, you can access the controller data via a PC, even when a fieldbus module is attached.

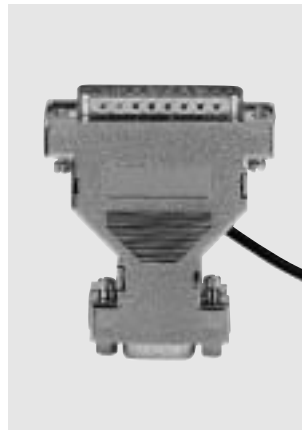

#### 9374IB terminal expansion

The terminal expansion serves as extension of the digital input and output terminals. All eight terminals can be freely programmed as inputs or outputs. By convenient connection via the system bus, a terminal expansion can be used for several controllers. The terminals have a response time of 1-2 ms.





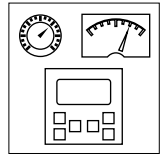

### BCD decade switch

By means of the BCD decade switch, different set-points (gear ratios or set positions) can be directly entered as digital values. In a system with several controllers in digital frequency cascade configuration, the gear ratios can thus be modified individually.



### Operation terminal

The operation terminal can be used to preset or display up to 128 data of a controller or controller group. This is especially helpful in distributed configurations, in order to allow diagnostics directly at the machine. The terminal is programmed via a comfortable user interface using Windows technique.



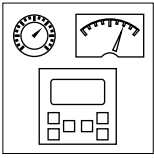

## 9300 Selection

### Digital display

#### Digital display

A voltmeter can be connected to the monitor outputs for the display of the output frequency or motor speed.

Name	Type	Ranges	Cut-out	Depth
Voltmeter 3 1/2 digits	EPD203	0 - 6 V 0 - 20 V 0 - 200 V	91 mm x 22.5 mm	81.5 mm



#### Setpoint potentiometer

The speed (setpoint input or field-frequency input) can be entered via an external potentiometer.

For this, the setpoint potentiometer is connected to terminals 7, 8, and 9. A scale and a knob are additionally available.

Name	Order No.	Data	Dimensions
Setpoint potentiometer	ERPD0010k0001W	10 k $\Omega$ / 1 Watt	6 mm x 35 mm
Knob	ERZ0001		36 mm diameter
Scale	ERZ0002	0...100 %	62 mm diameter





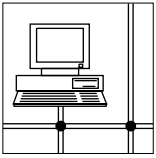

## 9300 Selection

### Communication with a host

#### Networking via the RS 232/485 interface

The controllers of the 9300 series can be easily networked with an RS 232 or RS 485 interface of a host (PLC or PC) using attachable modules. The modules are plugged on instead of the operation module. Three versions are available:

- 2102IBV001: RS 232/485 interface  
The RS 232 and RS 485 interfaces are 9-pole SubD connectors. The RS 485 interface offers a screw terminal for the connection with the next drive. We recommend to use the 2101IB level converter in addition for electrical isolation of the host.
- 2102IBV002: RS 485 interface  
The absolutely noise-immune and very economical networking via fibre is realized with a simple plastic fibre. The fibre optic is adapted to the module via a fibre-optic female connector. For the host, we offer simple plug-on components of the 2151IB series which can be plugged to the interface of the communication modules of your PLC.

The LECOM protocol is required for the communication via all three interfaces. We have completely published the LECOM protocol for your own applications. However, it is also completely integrated into different systems (e. g. Simatic S5) so that the integration into a control is very easy for you. For parameter setting, you can use Global Drive Control 1 Software.

#### Networking via the system bus (CAN)

The system bus of the 9300 servo is a slave connection with a communication profile according to CIA DS 301. All parameters of the controller can be read and written. Together with a miniature control, the process data can be transmitted directly.

#### Networking via hosts with high process speed

- 2111IB InterBus-S module  
Using the 2111IB module, the InterBus-S is connected directly to the remote bus. This connection supports the DRIVECOM profile 21. This very convenient way of networking controllers is achieved using a 9-pole Sub-D connector. A 15 V connection for an external supply of the remote bus is also available on the module.
- 2131IB Profibus module  
The PROFIBUS fieldbus module is a slave connection module with the PROFIBUS-DP communication profile. This module can be plugged on like the other fieldbus modules. It presents an interesting solution for the integration into a process with medium dynamic response.



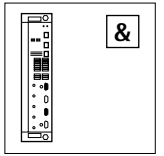

### Accessories for all devices

Name	Order number
9371 operation module	EMZ9371BB
Digital display	EPD203
Hand terminal	EMZ9372BB
Setpoint potentiometer	ERPD0010k0001W
Knob for potentiometer	ERZ0001
Scale for potentiometer	ERZ0002
RS232/485 fieldbus module	EMF2102IB-V001
RS485 fieldbus module	EMF2102IB-V002
Level converter for RS485	EMF2101IB
PC system cable for RS232/485	EWL0020
PC program for Global Drive controller	ESP-GDC
Fibre-optic fieldbus module	EMF2102IB-V003
Fibre-optic adapter for PLC 0...40 m	EMF2125IB
Power supply unit for fibre-optic adapter 2125	EJ0013
InterBus-S module	EMF2111IB
PROFIBUS module	EMF2131IB
Terminal expansion	EMZ9374IB
PC/System converter	EMF2173IB
BCD decade switch	
Operation terminal	

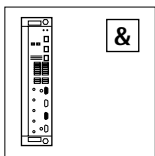

## 9300 Selection

### Survey of the accessories

#### 9321-9324 type specific accessories

Name	Order number			
	9321	9322	9323	9324
Automatic-circuit breaker	EFA3B06A	EFA3B06A	EFA3B10A	EFA3B10A
Fuse	EFSM-0060AWE	EFSM-0060AWE	EFSM-0100AWE	EFSM-0100AWE
Fuse holder	EFH1001	EFH1001	EFH1001	EFH1001
Mains filter type A	EZN3A2400H002	EZN3A1500H003	EZN3A0900H004	EZN3A0500H007
Mains filter type B	EZN3B2400H002	EZN3B1500H003	EZN3B0900H004	EZN3B0500H007
Brake module	EMB9351-E	EMB9351-E	EMB9351-E	EMB9351-E
Brake chopper	EMB9352-E	EMB9352-E	EMB9352-E	EMB9352-E
Brake resistor	ERBD180R300W	ERBD180R300W	ERBD082R600W	ERBD068R800W
Thermal separation (push-through)	EJ0036	EJ0036	EJ0037	EJ0037
DC bus fuse	EFSCC0060AYJ	EFSCC0060AYJ	EFSCC0080AYJ	EFSCC0120AYJ
Fuse holder	EFH20004	EFH20004	EFH20004	EFH20004

#### 9325-9328 type specific accessories

Name	Order number			
	9325	9326	9327	9328
Automatic-circuit breaker	EFA3B20A	EFA3B32A	-	-
Fuse	EFSM-0200AWE	EFSM-0320AWH	EFSFF-0630AYJ	EFSFF-0630AYJ
Fuse holder	EFH1001	EFH1001	EFH1001	EFH1001
Mains filter type A	EZN3A0300H013	EZN3A0150H024	EZN3A0110H030	EZN3A0080H042
Mains filter type B	EZN3B0300H013	EZN3B0150H024	EZN3B0110H030	EZN3B0080H042
Brake module	EMB9351-E	EMB9351-E	EMB9351-E	EMB9351-E
Brake chopper	EMB9352-E	EMB9352-E	EMB9352-E	EMB9352-E
Brake resistor	ERBD047R01k2	ERBD047R01k2	ERBD022R03k0	ERBD022R03k0
Thermal separation (push-through)	EJ0038	EJ0038	EJ0011	EJ0011
DC bus fuse	EFSCC0200AYJ	EFSCC0400AYJ	EFSCC0500AYJ	EFSCC0800AYJ
Fuse holder	EFH20004	EFH20004	EFH20004	EFH20004

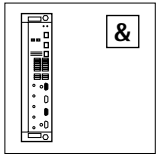

### 9329-9332 type specific accessories

Name	Order number			
	9329	9330	9331	9332
Controller				
Mains filter type A	EZN3A0055H060	EZN3A0037H090	EZN3A0022H150	EZN3A0022H150
Mains filter type B	EZN3B0055H060	EZN3B0037H090	EZN3B0022H150	EZN3B0022H150
Brake module	EMB9351-E	EMB9351-E	EMB9351-E	EMB9351-E
Brake chopper	EMB9352-E	EMB9352-E	EMB9352-E	EMB9352-E
Brake resistor	ERBD018R03k0	ERBD022R03k0 (2x)	ERBD018R03k0 (2x)	ERBD022R03k0 (3x)
Thermal separation (push-through)	EJ0011			
DC bus fuse	EFSCC1000AYJ	EFSCC0800AYJ (2x)	EFSCC1000AYJ (2x)	EFSCC0800AYJ (3x)
Fuse holder	EFH20004	EFH20004 (2x)	EFH20004 (2x)	EFH20004 (3x)

### 9341-9343 type specific accessories

Name	Order number		
	9341	9342	9343
Controller			
Mains filter type A	EZN3A0120H012	EZN3A0088H024	EZN3A0055H045
Mains filter type B	-	-	-
Brake module	-	-	-
Brake chopper	-	-	-
Brake resistor	-	-	-
Thermal separation (push-through)	EJ0038	EJ0038	EJ0011
DC bus fuse	EFSCC0160AYJ	EFSCC0320AYJ	EFSCC0800AYJ
Fuse holder	EFH20004	EFH20004	EFH20004





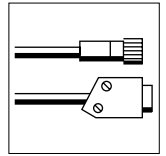

Preassembled system cables facilitate the connection of Lenze servo motors to the 9300 servo. The following cables are available (see figure):

- Motor cables
- Blower cables
- Cables for the regenerative power supply module
- Additional cables

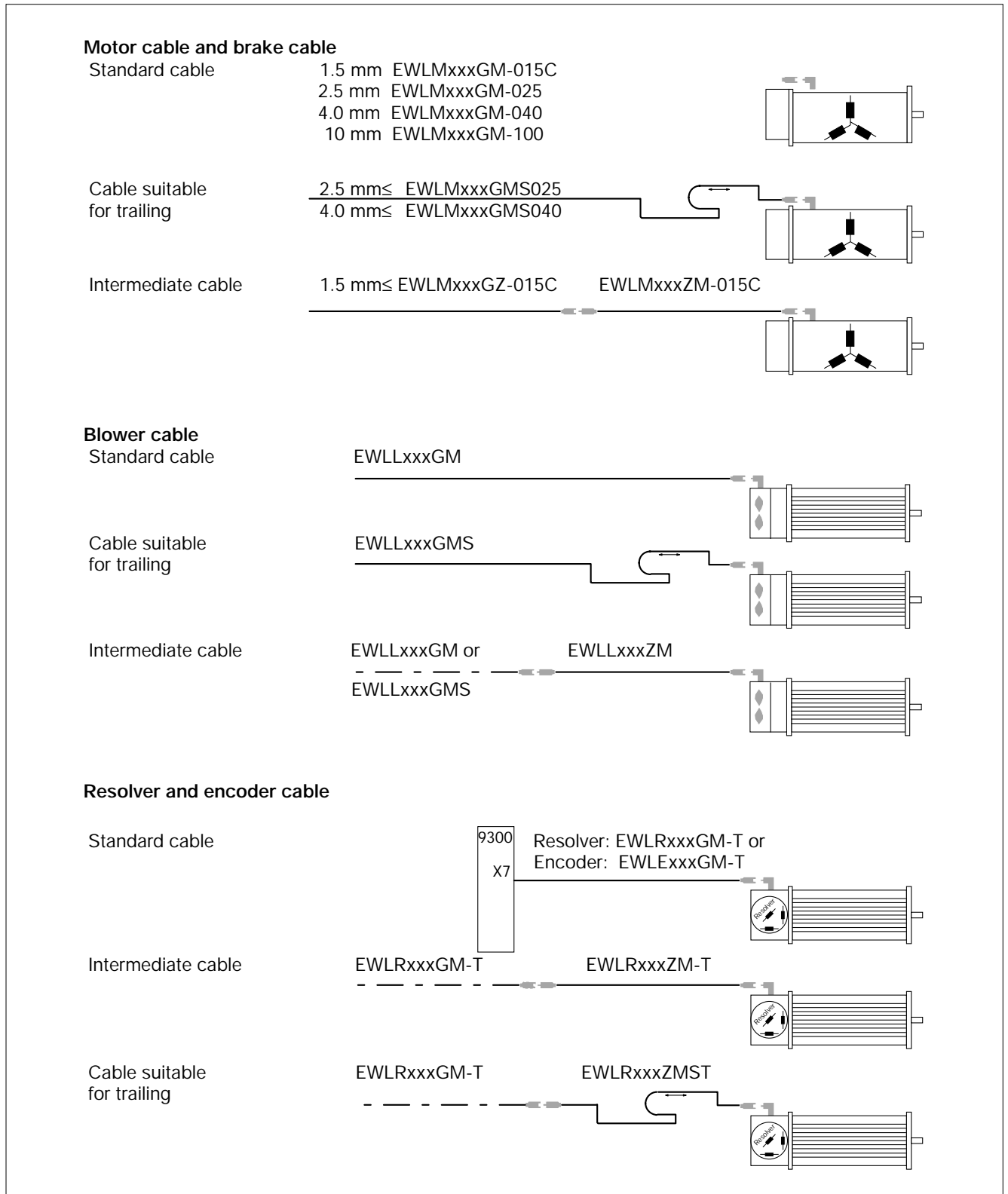

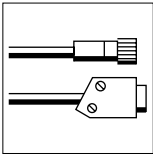

## 9300 Selection

### Motor cables

Preassembled motor cables facilitate the connection of servo motors to the 9300 servo. The cables have a connector at the motor side, the other side is open for control-cabinet cabling.  
Other advantages:

- Integrated brake connection
- Screened cable
- Wiring according to EMC
- Economical connection

Type	Length (m)	Connector for motor frame size	Current- carrying capacity * (A)	Core cross- section mm <sup>2</sup>	Cable diameter mm	Bending radius		Weight kg
						Fixed installation	Flex.installation **	
<b>1.5 mm<sup>2</sup> standard cable</b>								
EWLM002GM-015C	2.5	056 - 090	15.0	1.5	13.5	7.5 x d	15 x d	0.6
EWLM005GM-015C	5.0	056 - 090	15.0	1.5	13.5	7.5 x d	15 x d	1.0
EWLM010GM-015C	10.0	056 - 090	15.0	1.5	13.5	7.5 x d	15 x d	2.0
EWLM015GM-015C	15.0	056 - 090	15.0	1.5	13.5	7.5 x d	15 x d	2.4
EWLM020GM-015C	20.0	056 - 090	15.0	1.5	13.5	7.5 x d	15 x d	3.7
EWLM025GM-015C	25.0	056 - 090	15.0	1.5	13.5	7.5 x d	15 x d	4.6
EWLM030GM-015C	30.0	056 - 090	15.0	1.5	13.5	7.5 x d	15 x d	5.5
EWLM035GM-015C	35.0	056 - 090	15.0	1.5	13.5	7.5 x d	15 x d	6.4
EWLM040GM-015C	40.0	056 - 090	15.0	1.5	13.5	7.5 x d	15 x d	7.3
EWLM045GM-015C	45.0	056 - 090	15.0	1.5	13.5	7.5 x d	15 x d	8.2
EWLM050GM-015C	50.0	056 - 090	15.0	1.5	13.5	7.5 x d	15 x d	9.1
EWLM075GM-015C	75.0	056 - 090	15.0	1.5	13.5	7.5 x d	15 x d	13.6
EWLM100GM-015C	100.0	056 - 090	15.0	1.5	13.5	7.5 x d	15 x d	18.1
<b>2.5 mm<sup>2</sup> standard cable</b>								
EWLM002GM-025	2.5	056 - 090	20.0	2.5	11.3	7.5 x d	15 x d	0.7
EWLM005GM-025	5.0	056 - 090	20.1	2.5	11.3	7.5 x d	15 x d	1.3
EWLM010GM-025	10.0	056 - 090	20.0	2.5	11.3	7.5 x d	15 x d	2.5
EWLM015GM-025	15.0	056 - 090	20.0	2.5	11.3	7.5 x d	15 x d	3.7
EWLM020GM-025	20.1	056 - 090	20.1	2.5	11.3	7.5 x d	15 x d	4.9
EWLM025GM-025	25.0	056 - 090	20.1	2.5	11.3	7.5 x d	15 x d	6.1
EWLM030GM-025	30.0	056 - 090	20.1	2.5	11.3	7.5 x d	15 x d	7.3
EWLM035GM-025	35.0	056 - 090	20.1	2.5	11.3	7.5 x d	15 x d	8.5
EWLM040GM-025	40.0	056 - 090	20.1	2.5	11.3	7.5 x d	15 x d	9.7
EWLM045GM-025	45.0	056 - 090	20.1	2.5	11.3	7.5 x d	15 x d	10.9
EWLM050GM-025	50.0	056 - 090	20.1	2.5	11.3	7.5 x d	15 x d	12.1
EWLM075GM-025	75.0	056 - 090	20.1	2.5	11.3	7.5 x d	15 x d	18.1
EWLM100GM-025	100.0	056 - 090	20.1	2.5	11.3	7.5 x d	15 x d	24.1
<b>4.0 mm<sup>2</sup> standard cable</b>								
EWLM005GM-040	5.0	100 - 112	28.1	4.0	13.5	7.5 x d	15 x d	1.9
EWLM010GM-040	10.0	100 - 112	28.1	4.0	13.5	7.5 x d	15 x d	3.6
EWLM015GM-040	15.0	100 - 112	28.1	4.0	13.5	7.5 x d	15 x d	5.4
EWLM020GM-040	20.1	100 - 112	28.1	4.0	13.5	7.5 x d	15 x d	7.1
EWLM025GM-040	25.0	100 - 112	28.1	4.0	13.5	7.5 x d	15 x d	8.9
EWLM030GM-040	30.0	100 - 112	28.1	4.0	13.5	7.5 x d	15 x d	11.5
EWLM035GM-040	35.0	100 - 112	28.1	4.0	13.5	7.5 x d	15 x d	12.4
EWLM040GM-040	40.0	100 - 112	28.1	4.0	13.5	7.5 x d	15 x d	14.1
EWLM045GM-040	45.0	100 - 112	28.1	4.0	13.5	7.5 x d	15 x d	15.9
EWLM050GM-040	50.0	100 - 112	28.1	4.0	13.5	7.5 x d	15 x d	17.6
EWLM075GM-040	75.0	100 - 112	28.1	4.0	13.5	7.5 x d	15 x d	26.4
EWLM100GM-040	100.0	100 - 112	28.1	4.0	13.5	7.5 x d	15 x d	35.1
<b>10.0 mm<sup>2</sup> standard cable</b>								
EWLM005GM-100	5.0	100 - 112	50.0	10.0	19.5	7.5 x d	15 x d	4.0
EWLM010GM-100	10.0	100 - 112	50.0	10.0	19.5	7.5 x d	15 x d	7.8
EWLM015GM-100	15.0	100 - 112	50.0	10.0	19.5	7.5 x d	15 x d	11.7
EWLM020GM-100	20.1	100 - 112	50.0	10.0	19.5	7.5 x d	15 x d	15.4
EWLM025GM-100	25.0	100 - 112	50.0	10.0	19.5	7.5 x d	15 x d	19.4
EWLM030GM-100	30.0	100 - 112	50.0	10.0	19.5	7.5 x d	15 x d	23.2
EWLM035GM-100	35.0	100 - 112	50.0	10.0	19.5	7.5 x d	15 x d	27.1
EWLM040GM-100	40.0	100 - 112	50.0	10.0	19.5	7.5 x d	15 x d	30.9
EWLM045GM-100	45.0	100 - 112	50.0	10.0	19.5	7.5 x d	15 x d	34.8
EWLM050GM-100	50.0	100 - 112	50.0	10.0	19.5	7.5 x d	15 x d	38.6
EWLM075GM-100	75.0	100 - 112	50.0	10.0	19.5	7.5 x d	15 x d	57.9
EWLM100GM-100	100.0	100 - 112	50.0	10.0	19.5	7.5 x d	15 x d	77.1

\* according to VDE 298, mounting position B2 at 25 °C ambient temperature      \*\* repeated bending not permitted

Caution: The cable cross-section must be selected according to the rated motor current.

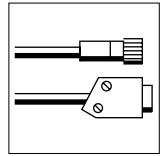

## Cables suitable for trailing

When running positioning and traversing drives with servos, special connecting cables are required in many cases. Lenze offers the user cables which are suitable for

trailing. In addition to the advantages of the standard cables, they are designed for continuous movement.

Type	Length (m)	Connector for motor frame size	Current- carrying capacity * (A)	Core cross- section mm <sup>2</sup>	Cable diameter- mm	Bending radius		Weight kg
						Fixed installation	In trailing operation	
<b>2.5 mm<sup>2</sup> cable suitable for trailing</b>								
EWLM002GMS025	5.0	056 - 090	20.0	2.5	12.8	5 x d	10 x d	1.4
EWLM005GMS025	10.0	056 - 090	20.0	2.5	12.8	5 x d	10 x d	2.7
EWLM010GMS025	15.0	056 - 090	20.0	2.5	12.8	5 x d	10 x d	4.0
EWLM015GMS025	20.0	056 - 090	20.0	2.5	12.8	5 x d	10 x d	5.3
EWLM020GMS025	25.0	056 - 090	20.0	2.5	12.8	5 x d	10 x d	6.6
EWLM025GMS025	30.0	056 - 090	20.0	2.5	12.8	5 x d	10 x d	7.9
EWLM030GMS025	35.0	056 - 090	20.0	2.5	12.8	5 x d	10 x d	9.2
EWLM040GMS025	40.0	056 - 090	20.0	2.5	12.8	5 x d	10 x d	10.5
EWLM050GMS025	50.0	056 - 090	20.0	2.5	12.8	5 x d	10 x d	20.5
EWLM075GMS025	75.0	056 - 090	20.0	2.5	12.8	5 x d	10 x d	26.1
EWLM100GMS025	100.0	056 - 090	20.0	2.5	12.8	5 x d	10 x d	32.1
<b>4.0 mm<sup>2</sup> cable suitable for trailing</b>								
EWLM002GMS040	5.0	100 - 112	28.0	4.0	14.0	5 x d	10 x d	1.1
EWLM005GMS040	10.0	100 - 112	28.0	4.0	14.0	5 x d	10 x d	1.9
EWLM010GMS040	15.0	100 - 112	28.0	4.0	14.0	5 x d	10 x d	3.6
EWLM015GMS040	20.0	100 - 112	28.0	4.0	14.0	5 x d	10 x d	5.4
EWLM020GMS040	25.0	100 - 112	28.0	4.0	14.0	5 x d	10 x d	7.1
EWLM025GMS040	30.0	100 - 112	28.0	4.0	14.0	5 x d	10 x d	8.9
EWLM030GMS040	35.0	100 - 112	28.0	4.0	14.0	5 x d	10 x d	11.5
EWLM040GMS040	40.0	100 - 112	28.0	4.0	14.0	5 x d	10 x d	14.1
EWLM050GMS040	50.0	100 - 112	28.0	4.0	14.0	5 x d	10 x d	17.6
EWLM075GMS040	75.0	100 - 112	28.0	4.0	14.0	5 x d	10 x d	26.4
EWLM100GMS040	100.0	100 - 112	28.0	24.0	14.0	5 x d	10 x d	35.1

If the drive is initialized in the factory, the whole system must be wired up. After commissioning, all connections must be removed again.

Intermediate cables are very advantageous for this. Motor plugs are connected to one end of the cable, couplings to the other end. The plug-in connectors extend the motor cable and facilitate dismantling considerably.

Type	Length (m)	Connector for motor frame size	Current- carrying capacity * (A)	Core cross- section mm <sup>2</sup>	Cable diameter mm	Bending radius		Weight kg
						Fixed installation	Flex.installation **	
<b>1.5 mm<sup>2</sup> intermediate inverter cable</b>								
EWLM002GZ-015C	2.5	056 - 090	15.0	1.5	13.5	7.5 x d	15 x d	0.7
EWLM005GZ-015C	5.0	056 - 090	15.0	1.5	13.5	7.5 x d	15 x d	1.1
EWLM007GZ-015C	7.5	056 - 090	15.0	1.5	13.5	7.5 x d	15 x d	1.6
EWLM010GZ-015C	0.0	056 - 090	15.0	1.5	13.5	7.5 x d	15 x d	2.0
EWLM015GZ-015C	15.0	056 - 090	15.0	1.5	13.5	7.5 x d	15 x d	2.9
EWLM020GZ-015C	20.0	056 - 090	15.0	1.5	13.5	7.5 x d	15 x d	3.8
EWLM030GZ-015C	30.0	056 - 090	15.0	1.5	13.5	7.5 x d	15 x d	5.6
EWLM050GZ-015C	50.0	056 - 090	15.0	1.5	13.5	7.5 x d	15 x d	9.2
<b>1.5 mm<sup>2</sup> intermediate motor cable</b>								
EWLM002ZM-015C	2.5	056 - 090	15.0	1.5	13.5	7.5 x d	15 x d	0.7
EWLM005ZM-015C	5.0	056 - 090	15.0	1.5	13.5	7.5 x d	15 x d	1.1
EWLM007ZM-015C	7.5	056 - 090	15.0	1.5	13.5	7.5 x d	15 x d	1.6
EWLM010ZM-015C	0.0	056 - 090	15.0	1.5	13.5	7.5 x d	15 x d	2.0
EWLM015ZM-015C	15.0	056 - 090	15.0	1.5	13.5	7.5 x d	15 x d	2.9
EWLM020ZM-015C	20.0	056 - 090	15.0	1.5	13.5	7.5 x d	15 x d	3.8
EWLM030ZM-015C	30.0	056 - 090	15.0	1.5	13.5	7.5 x d	15 x d	5.6
EWLM050ZM-015C	50.0	056 - 090	15.0	1.5	13.5	7.5 x d	15 x d	9.2

\* according to VDE 298, mounting position B2 at 25 °C ambient temperature \*\* repeated bending not permitted  
Caution: The cable cross-section must be selected according to the rated motor current.

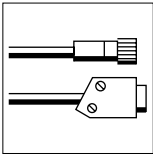

## 9300 Selection

### Blower cables

Global Drive servo motors can be equipped with a separate blower on the B-side. The connection is possible via a cable.

A plug on the motor side enables an easy connection of the blower cable. You can choose between standard cables and cables suitable for trailing.

Type	Length (m)	Cross-section/ number of cores (mm <sup>2</sup> )	Cable diameter mm	Bending radius		Weight kg
				Fixed installation	Flex.installation**	
<b>Standard cable</b>						
EWLL002GM	2.5	0.5	7.2	10 x d	15 x d	0.3
EWLL005GM	5.0	0.5	7.2	10 x d	15 x d	0.4
EWLL010GM	10.0	0.5	7.2	10 x d	15 x d	0.7
EWLL015GM	15.0	0.5	7.2	10 x d	15 x d	1.0
EWLL020GM	20.0	0.5	7.2	10 x d	15 x d	1.3
EWLL025GM	25.0	0.5	7.2	10 x d	15 x d	1.6
EWLL030GM	30.0	0.5	7.2	10 x d	15 x d	1.9
EWLL035GM	35.0	0.5	7.2	10 x d	15 x d	2.2
EWLL040GM	40.0	0.5	7.2	10 x d	15 x d	2.5
EWLL045GM	45.0	0.5	7.2	10 x d	15 x d	2.8
EWLL050GM	50.0	0.5	7.2	10 x d	15 x d	3.1
EWLL075GM	75.0	0.5	7.2	10 x d	15 x d	4.6
EWLL100GM	100.0	0.5	7.2	10 x d	15 x d	6.1
<b>Cable suitable for trailing</b>						
EWLL002GMS	2.5	0.5	7.0	6 x d	10 x d	0.3
EWLL005GMS	5.0	0.5	7.0	6 x d	10 x d	0.4
EWLL010GMS	10.0	0.5	7.0	6 x d	10 x d	0.7
EWLL015GMS	15.0	0.5	7.0	6 x d	10 x d	1.0
EWLL020GMS	20.0	0.5	7.0	6 x d	10 x d	1.3
EWLL025GMS	25.0	0.5	7.0	6 x d	10 x d	1.6
EWLL035GMS	30.0	0.5	7.0	6 x d	10 x d	1.9
EWLL040GMS	40.0	0.5	7.0	6 x d	10 x d	2.5
EWLL050GMS	50.0	0.5	7.0	6 x d	10 x d	3.1
EWLL075GMS	75.0	0.5	7.0	6 x d	10 x d	4.6
EWLL100GMS	100.0	0.5	7.0	6 x d	10 x d	6.1

The blower cable can be connected in the same way as the motor cable.

This intermediate cable also has male/female connectors at both ends.

Type	Length (m)	Cross-section/ number of cores (mm <sup>2</sup> )	Cable diameter mm	Bending radius		Weight kg
				Fixed installation	Flex.installation**	
<b>Intermediate motor cable</b>						
EWLL002ZM	2.5	0.5	7.2	10 x d	15 x d	0.4
EWLL005ZM	5.0	0.5	7.2	10 x d	15 x d	0.6
EWLL007ZM	7.5	0.5	7.2	10 x d	15 x d	0.9
EWLL010ZM	10.0	0.5	7.2	10 x d	15 x d	1.1
EWLL015ZM	15.0	0.5	7.2	10 x d	15 x d	1.6
EWLL020ZM	20.0	0.5	7.2	10 x d	15 x d	2.1
EWLL030ZM	30.0	0.5	7.2	10 x d	15 x d	3.1
EWLL050ZM	50.0	0.5	7.2	10 x d	15 x d	5.1

\*\* repeated bending not permitted

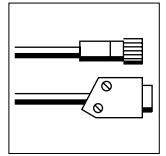

## Resolver cables / Encoder cables

You can also use resolvers for the feedback. We provide cables with plugs on both ends to connect the controller with the motor. They are available up to a length of 100 m.

The resolver cable can easily be extended. You can choose between standard intermediate cables and intermediate cables suitable for trailing.

Type	Length (m)	Cross-section/ number of cores (mm <sup>2</sup> )	Cable diameter mm	Bending radius		Weight kg
				Fixed installation	Flex.installation**	
<b>Standard cable</b>						
EWLR002GM-T	2.5	1x(2x0.5)+3x(2x0.14)	9.3	7.5 x d	15 x d	0.4
EWLR005GM-T	5.0	1x(2x0.5)+3x(2x0.14)	9.3	7.5 x d	15 x d	0.6
EWLR010GM-T	10.0	1x(2x0.5)+3x(2x0.14)	9.3	7.5 x d	15 x d	1.1
EWLR015GM-T	15.0	1x(2x0.5)+3x(2x0.14)	9.3	7.5 x d	15 x d	1.6
EWLR020GM-T	20.0	1x(2x0.5)+3x(2x0.14)	9.3	7.5 x d	15 x d	2.1
EWLR025GM-T	25.0	1x(2x0.5)+3x(2x0.14)	9.3	7.5 x d	15 x d	2.6
EWLR030GM-T	30.0	1x(2x0.5)+3x(2x0.14)	9.3	7.5 x d	15 x d	3.1
EWLR035GM-T	35.0	1x(2x0.5)+3x(2x0.14)	9.3	7.5 x d	15 x d	3.6
EWLR040GM-T	40.0	1x(2x0.5)+3x(2x0.14)	9.3	7.5 x d	15 x d	4.1
EWLR045GM-T	45.0	1x(2x0.5)+3x(2x0.14)	9.3	7.5 x d	15 x d	4.6
EWLR050GM-T	50.0	1x(2x0.5)+3x(2x0.14)	9.3	7.5 x d	15 x d	5.1
EWLR075GM-T	75.0	1x(2x0.5)+3x(2x0.14)	9.3	7.5 x d	15 x d	7.6
EWLR100GM-T	100.0	1x(2x0.5)+3x(2x0.14)	9.3	7.5 x d	15 x d	10.1
<b>Intermediate cable suitable for trailing</b>						
EWLR005ZMST	5.0	1x(2x0.5) + 3x(2x0.14)	11.6	5 x d	10 x d	1.0
EWLR010ZMST	10.0	1x(2x0.5) + 3x(2x0.14)	11.6	5 x d	10 x d	1.7
EWLR015ZMST	15.0	1x(2x0.5) + 3x(2x0.14)	11.6	5 x d	10 x d	2.5
EWLR020ZMST	20.0	1x(2x0.5) + 3x(2x0.14)	11.6	5 x d	10 x d	3.2
EWLR025ZMST	25.0	1x(2x0.5) + 3x(2x0.14)	11.6	5 x d	10 x d	4.0
EWLR030ZMST	30.0	1x(2x0.5) + 3x(2x0.14)	11.6	5 x d	10 x d	4.7
EWLR040ZMST	40.0	1x(2x0.5) + 3x(2x0.14)	11.6	5 x d	10 x d	6.2
EWLR050ZMST	50.0	1x(2x0.5) + 3x(2x0.14)	11.6	5 x d	10 x d	7.7
EWLR075ZMST	75.0	1x(2x0.5) + 3x(2x0.14)	11.6	5 x d	10 x d	11.5
EWLR100ZMST	100.0	1x(2x0.5) + 3x(2x0.14)	11.6	5 x d	10 x d	15.2
<b>Intermediate resolver cable</b>						
EWLR002ZM-T	2.5	1x(2x0.5) + 3x(2x0.14)	9.3	7.5 x d	15 x d	0.4
EWLR005ZM-T	5.0	1x(2x0.5) + 3x(2x0.14)	9.3	7.5 x d	15 x d	0.6
EWLR007ZM-T	7.5	1x(2x0.5) + 3x(2x0.14)	9.3	7.5 x d	15 x d	0.9
EWLR010ZM-T	10.0	1x(2x0.5) + 3x(2x0.14)	9.3	7.5 x d	15 x d	1.1
EWLR015ZM-T	15.0	1x(2x0.5) + 3x(2x0.14)	9.3	7.5 x d	15 x d	1.6
EWLR020ZM-T	20.0	1x(2x0.5) + 3x(2x0.14)	9.3	7.5 x d	15 x d	2.1
EWLR030ZM-T	30.0	1x(2x0.5) + 3x(2x0.14)	9.3	7.5 x d	15 x d	3.1
EWLR050ZM-T	50.0	1x(2x0.5) + 3x(2x0.14)	9.3	7.5 x d	15 x d	5.1
<b>Standard encoder cable</b>						
EWLE002GM-T	2.5	1x(2x1.0) + 4x(2x0.14)	10.7	7.5 x d	15 x d	0.4
EWLE005GM-T	5.0	1x(2x1.0) + 4x(2x0.14)	10.7	7.5 x d	15 x d	0.7
EWLE010GM-T	10.0	1x(2x1.0) + 4x(2x0.14)	10.7	7.5 x d	15 x d	1.4
EWLE015GM-T	15.0	1x(2x1.0) + 4x(2x0.14)	10.7	7.5 x d	15 x d	2.1
EWLE020GM-T	20.0	1x(2x1.0) + 4x(2x0.14)	10.7	7.5 x d	15 x d	2.8
EWLE025GM-T	25.0	1x(2x1.0) + 4x(2x0.14)	10.7	7.5 x d	15 x d	3.4
EWLE030GM-T	30.0	1x(2x1.0) + 4x(2x0.14)	10.7	7.5 x d	15 x d	4.1
EWLE035GM-T	35.0	1x(2x1.0) + 4x(2x0.14)	10.7	7.5 x d	15 x d	4.8
EWLE040GM-T	40.0	1x(2x1.0) + 4x(2x0.14)	10.7	7.5 x d	15 x d	5.5
EWLE045GM-T	45.0	1x(2x1.0) + 4x(2x0.14)	10.7	7.5 x d	15 x d	6.2
EWLE050GM-T	50.0	1x(2x1.0) + 4x(2x0.14)	10.7	7.5 x d	15 x d	6.9
EWLE075GM-T	75.0	1x(2x1.0) + 4x(2x0.14)	10.7	7.5 x d	15 x d	10.3
EWLE100GM-T	100.0	1x(2x1.0) + 4x(2x0.14)	10.7	7.5 x d	15 x d	13.8

\*\* repeated bending not permitted

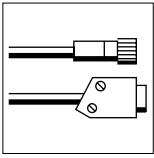

## 9300 Selection

### Other system cables

The 9300 servo inverter can be operated with a digital frequency via the digital frequency input (X 9). It is possible to establish a digital frequency interconnection to other

controllers of the system via the additional digital frequency output (X 10). A corresponding Digset cable connects the two controllers to each other.

Type	Length (m)	Cross-section number of cores (mm <sup>2</sup> )	Cable diameter mm	Bending radius		Weight kg
				Fixed installation	Flex.Installation	
EWLD002GGBS93	2.5	1x(2x0.5) + 3x(2x0.14)	9.3	7.5 x d	15 x d	0.4

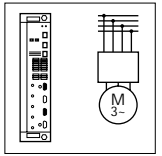

### Information about the power connection

Select the cable cross-section of the mains cables according to the maximum input current.  
Connect the mains cables to the screw terminals L1, L2, L3 at the top of the controller. Tightening torque: 0.5 - 0.6 Nm.

Apply the screen correctly:

- Screw the screen plate on the fixing bracket.
- Fix screen using links.  
Do not use as strain relief!
- The PE connection is made via the stud next to the power connections.

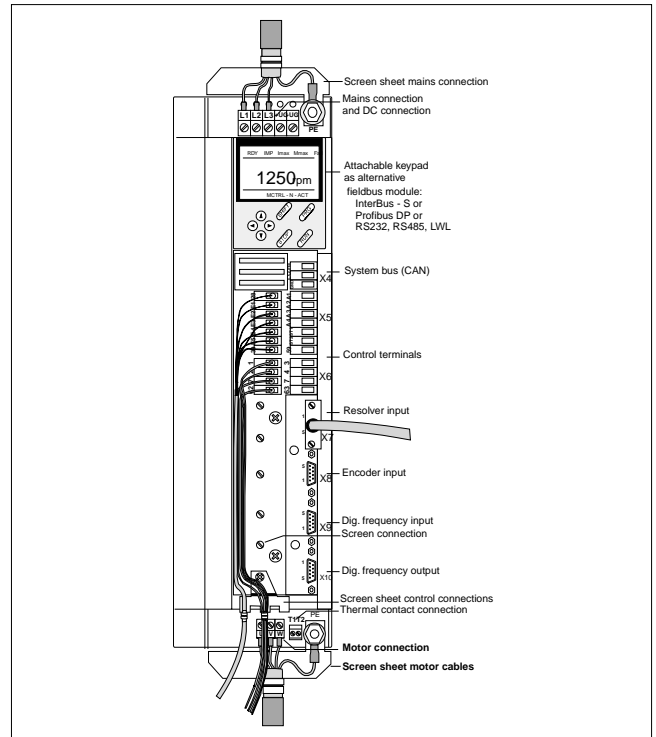

### Information about the motor connection

Select the cable cross-section of the motor cables according to the maximum output current.  
Connect the motor cables to the screw terminals U, V, W. Tightening torque: 0.5 - 0.6 Nm.

Apply the screen correctly:

- see power connection.

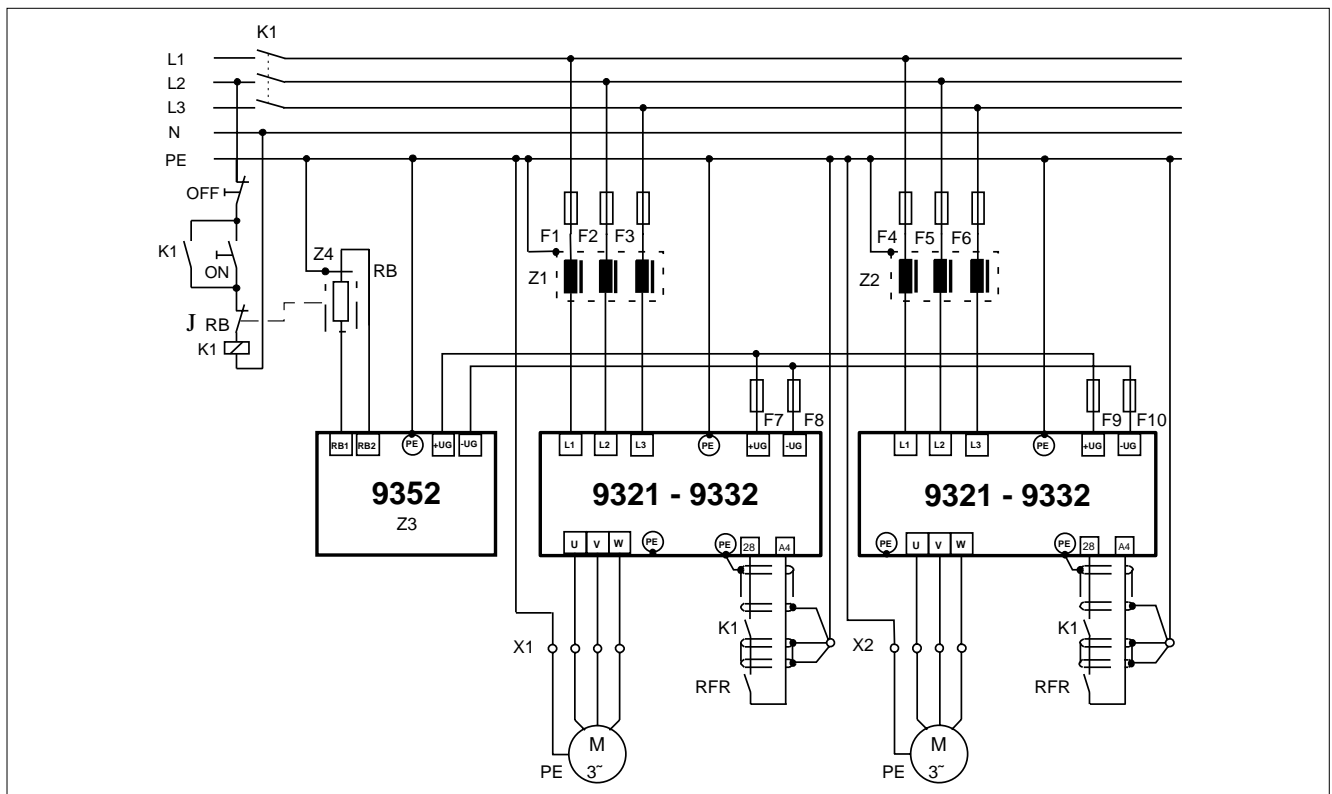

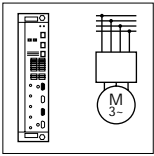

# Connecting diagrams

## 9300 servo inverters

### Information about the control cables

The servo inverters have some digital and analog inputs and outputs. These can be supplied with an internal or external control voltage.

The control connections have a basic insulation.

If protection against contact is required,

- a double insulation is necessary.
- the components to be connected must have a second isolating distance.

The following connecting diagrams can be distinguished:

With internal control voltage	With external control voltage
Digital inputs and outputs	Digital inputs and outputs
Analog inputs and outputs	Analog inputs and outputs

### Information about the wiring

Connect the control cables to the screw terminals X5 and X6 at the front of the controller.

Tightening torque: 0.5 - 0.6 Nm.

Screening of the control cables.

- The PE connection is made via the screen plate as shown (included in the accessory kit). Do not use as a strain relief!
- Connect the screen plate at the controller in the connecting area to the PE area using a screw.

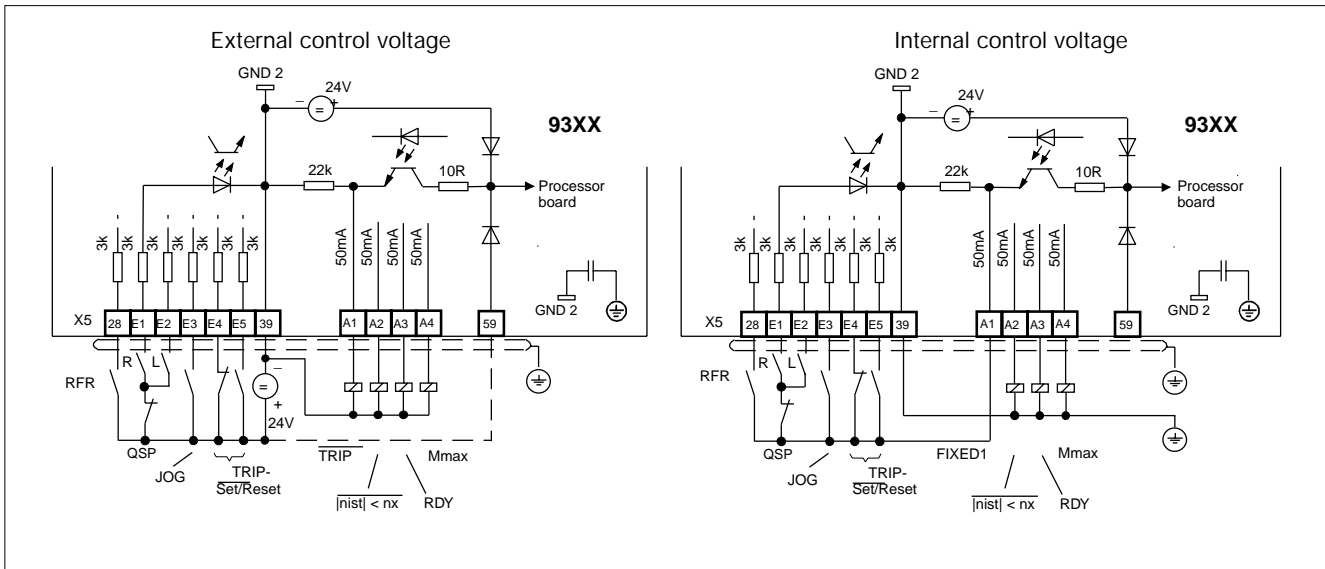

Example: Assignment of the input and output terminals



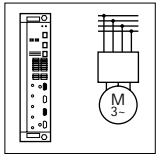

### DC-bus connection with 9340 regenerative power supply modules

In multi-axis operation of the servo, the use of a regenerative power supply module offers advantages.

The following circuit diagram shows a wiring proposal of a DC-bus connection.

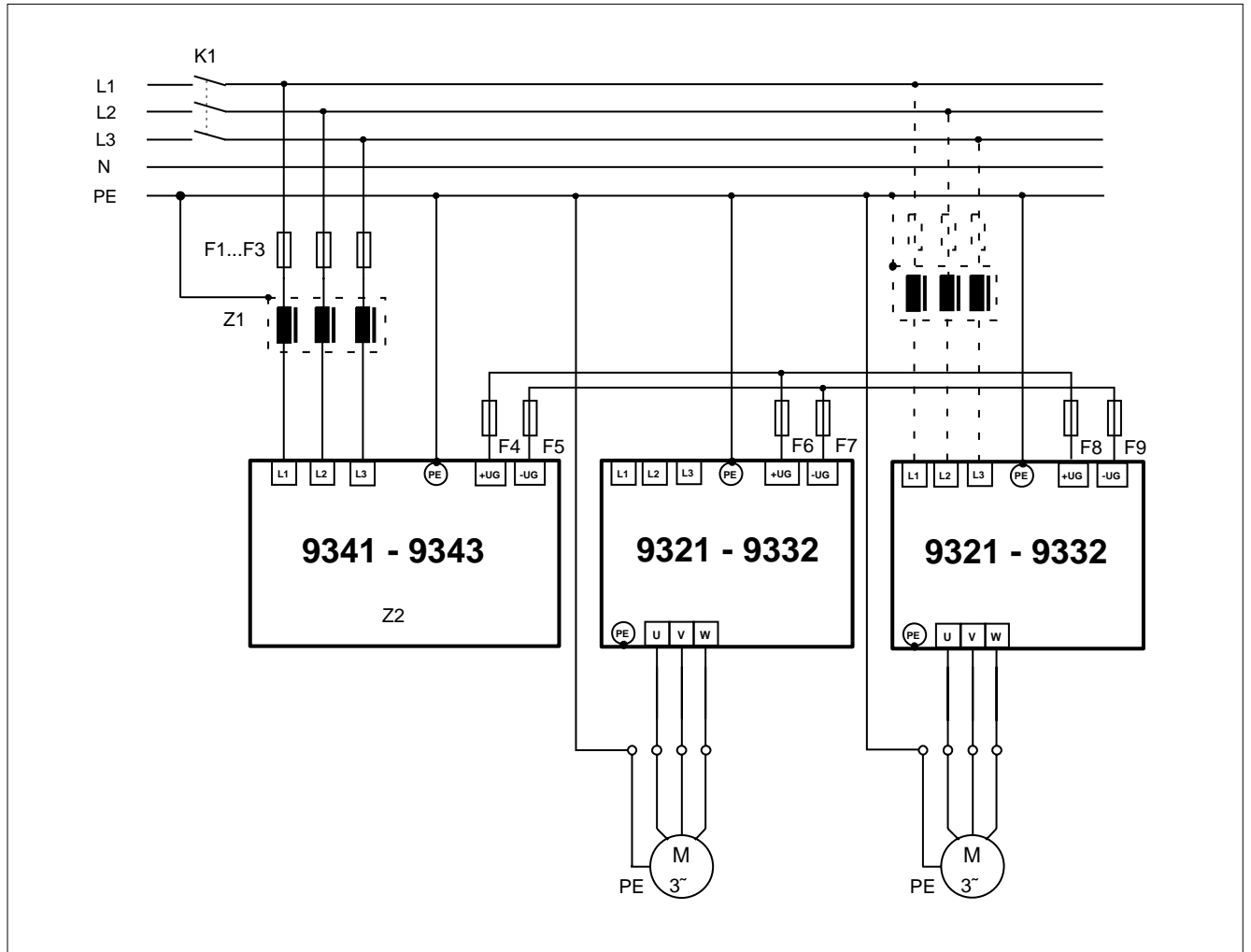

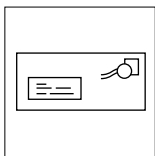

# Order form

Recipient: **Lenze**  
Branch office/  
Representative

Postal code/city: \_\_\_\_\_

Fax number: \_\_\_\_\_

## 93XX servo with accessories

**Sender**

Company \_\_\_\_\_ Customer no. \_\_\_\_\_

Street / P.O. box \_\_\_\_\_ Order no. \_\_\_\_\_

Postal code / City \_\_\_\_\_ Issuer \_\_\_\_\_

Address for delivery\* \_\_\_\_\_ Phone \_\_\_\_\_

\_\_\_\_\_ Fax \_\_\_\_\_

Invoice addressee\* \_\_\_\_\_ Date of delivery \_\_\_\_\_

\* Please fill out when not sender. Date \_\_\_\_\_ Signature \_\_\_\_\_

Name	Type	Pieces	Price	Type	Pieces	Price
Servo	EVS93__-E			EVS93__-E		
Automatic-circuit breaker						
Fuse						
Fuse holder						
Mains filter A						
Mains filter B						
Thermal separation						
DC fuses						
Fuse holder						
Brake chopper						
Brake resistor						

Name	Type	Pieces	Price
Setpoint potentiometer	ERPD0010k0001W		
Knob for potentiometer	ERZ0001		
Scale for potentiometer	ERZ0002		
Operation module 9371BB	EMZ9371BB		
Digital display	EPD203		
Brake module	EMB9351-E		
LECOM A/B module	EMF2102IB-V001		
LECOM B module	EMF2102IB-V002		
Level converter for LECOM B	EMF2101IB		
PC system cable LECOM A/B	EWL0001		
LECOM LI module	EMF2102IB-V003		
Fibre-optic adapter for PLC 0...40 m	EMF2125IB		
Power supply unit for 2125	EJ0013		
InterBus-S module	EMF2111IB		
PROFIBUS module	EMF2131IB		

# Order form

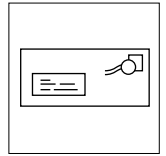

Recipient: **Lenze**  
Branch office/  
Representative

Postal code/city: \_\_\_\_\_

Fax number.: \_\_\_\_\_

**934XE regenerative power supply module**

**Sender**

Company \_\_\_\_\_ Customer no. \_\_\_\_\_

Street / P.O. box \_\_\_\_\_ Order no. \_\_\_\_\_

Postal code / City \_\_\_\_\_ Issuer \_\_\_\_\_

Address for delivery\* \_\_\_\_\_ Phone \_\_\_\_\_

\_\_\_\_\_ Fax \_\_\_\_\_

Invoice addressee\* \_\_\_\_\_ Date of delivery \_\_\_\_\_

\* Please fill out when not sender. Date \_\_\_\_\_ Signature \_\_\_\_\_

Name	Type	Pieces	Price	Type	Pieces	Price
Regenerative power supply module	EMB934__-E			EMB934__-E		
Fuse						
Fuse holder						
Mains filter A						
Thermal separation						