

Model 4683-TTM-x RS-485 TO RS-485 Network Repeater

Acromag's RS-485 network repeater device allows users to take full advantage of the RS-485 standard's extended communication distances and multi-dropping capabilities. In addition, these devices offer field selectable End-of-Line Network (EOLN) terminations on both the A and B networks.

Operation is transparent to all devices and no handshaking is required. Up to thirty-two RS-485 devices can be driven. Network repeaters are ready to mount on any base plate. Or, for a harsh environment, it can be installed in a NEMA enclosure of your choice. No enclosure is necessary for use in a laboratory or office. Installation requires mounting, connecting power and cables, and setting the baud rate.

Features

- No handshaking.
- No extra control lines.
- I/O signal isolation.
- Baud rates of 300, 600, 1200, 2400, 4800, 9600, 19.2K, and 38.4K are switch selectable.
- Field-selectable end-of-line network terminations on both A and B sides.
- Electrical transient protection is provided. This protects the host computer from destructive noise spikes and other transient signals.
- Status LED's indicate transmission direction, RS-485 bus fault conditions, and power applied.
- 115V and 230V AC power models available.

Ordering Information

4683-TTM-1 for 115V AC Power
4683-TTM-2 for 230V AC Power

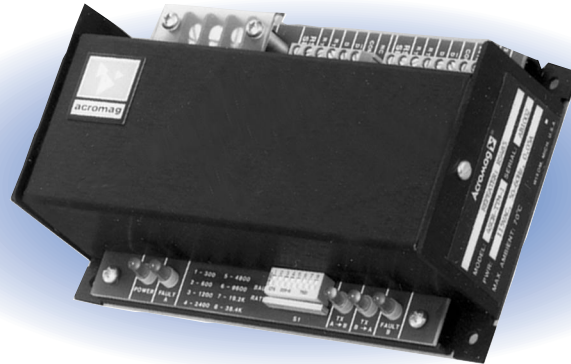

Acromag's network repeaters isolate and boost RS-485 signals allowing communication signals to travel another 4000 ft.

Operation

The Model 4683-TTM-1(2) network repeaters isolate and boost RS-485 signals allowing communication signals to travel another 4000 ft. Each repeater permits the addition of another thirty-two unit loads to a network.

The repeater has two RS-485 "sides" known as the A and B sides. The A side typically connects to the network towards the host and the B side connects to the extended network. Functionally, the A and B sides are equivalent.

The repeater receives AC power through a three-screw terminal strip. Transient signal protection is provided on both RS-485 sides.

When both RS-485 lines are idle, each side is in the receive mode. When a one to zero transition is detected (signifying a start bit) on either side, the opposite side's transmitter is enabled. The transmitter stays enabled for one character's time (based on the baud rate switch setting). The character received is then passed through.

Communications Specifications

Baud Rates: Switch settings on unit for 300, 600, 1200, 2400, 4800, 9600, 19.2K, and 38.4K baud rates. Switch must be in the proper baud rate position for proper operation.

RS-485 Bus Loading: One unit load equivalent.

RS-485 Bus Drive: Complete RS-485 compliance for up to 32 unit loads (31 unit loads if a repeater is used).

End-of-Line Termination Network:

The EOLN termination network is shown on the right and is individually selected on both the A and B sides by a pair of shorting clips. The A-side is controlled by jumper pair J1, J2 and the B-side is controlled by jumper pair J3 and J4.

The EOLN termination network is enabled for the A side or B side when the associated pair of jumpers are positioned over pins 1 and 2. Conversely, the EOLN is

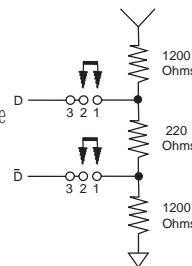

disabled (out of the circuit) when the pair jumpers are positioned over pins 2 and 3.

Duplex: Half duplex only.

Data Format: Ten bits typical (1 start bit, 8 data bits, and 1 stop bit). Other formats are supported.

Physical Specifications

Operating Temp. Range: 0 to 70° C (32 to 158° F).

Storage Temp. Range: -25 to +85° C (-13 to 185° F).

Relative Humidity (RH): 10 to 95% RH (noncondensing), up to 40° C (104° F).

Power: Model 4683-TTM-1 - 115VAC
+/-10%, 50/60 Hz, 0.05A

Model 4683-TTM-2 - 230VAC
+/-10%, 50/60 Hz, 0.03A

Power Line Fuse: 0.5A, 250V, 3AG type.

Isolation: The network repeater provides galvanic and opto-coupler isolation between RS-485(A), RS-485(B), AC power, and chassis ground. Common mode voltages are permitted up to 250V rms or 354V DC (withstands a 1500V AC dielectric strength test for 1 min. without breakdown) on a continuous basis. Complies with test requirements outlined in ANSI C39.5-1974 for voltage ratings specified.

RFI Resistance: Withstands an RFI field strength of 10V per meter at 27 Mhz, 151 Mhz, and 467 Mhz with no digital effect, per SAMA PMC 33.1 test procedures.

Line Noise Effects: Field and power line terminals withstand ANSI/IEEE C37.90-1978 Surge Withstanding Capability (SWC) Test with no component failures. Unit is tested to a standardized test waveform that is representative of surges (high-freq. transient electrical interference), observed in actual installations.

Communications Connections: Network repeater - both RS-485 conn. use modular terminal blocks with screw clamps. Wire range 14 to 26 AWG, CSA approval.

Power Wire Connections: Network repeater term. block. See label on unit for power to be applied to unit.

Approvals: UL Listed, CSA Certified file LR25710.

Shipping Weight: 3.0 pounds (1.4 kg) packed per unit.

B SIDE (EOLN) END OF LINE NETWORK CONFIGURATION

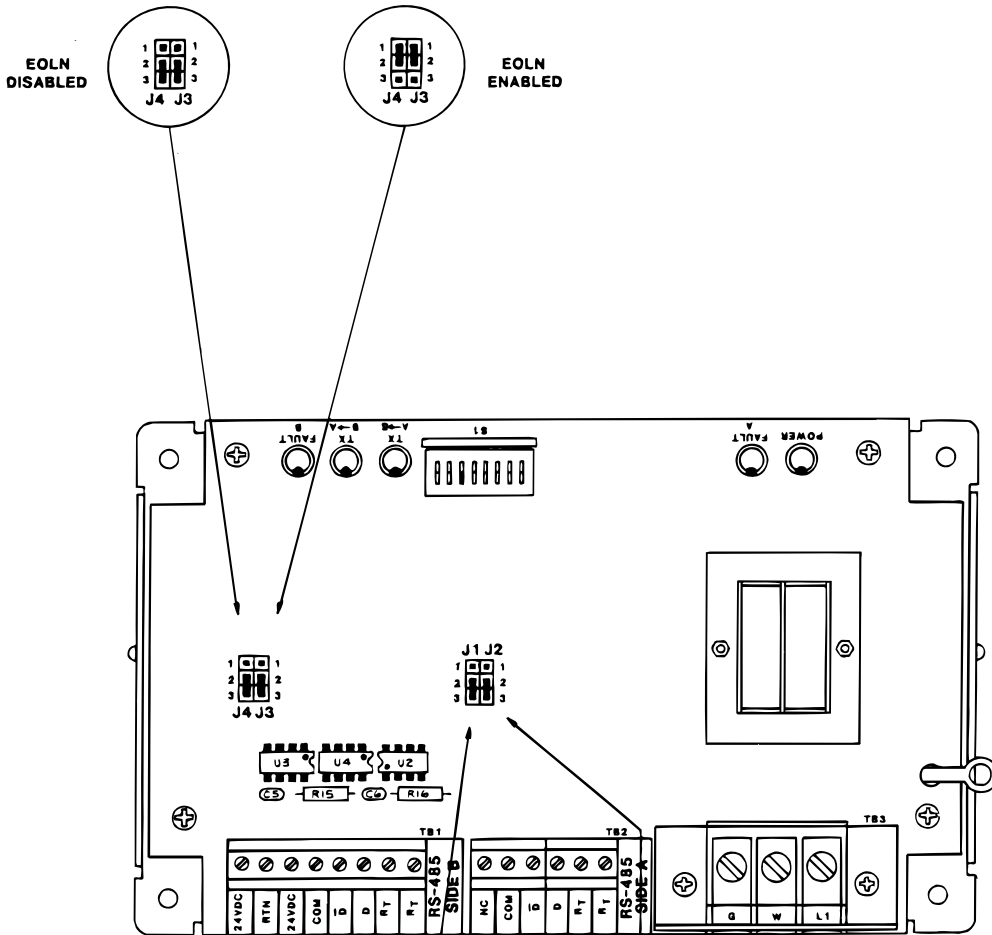

EOLN
DISABLED

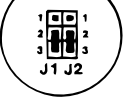

EOLN
ENABLED



A SIDE (EOLN) END OF LINE NETWORK CONFIGURATION

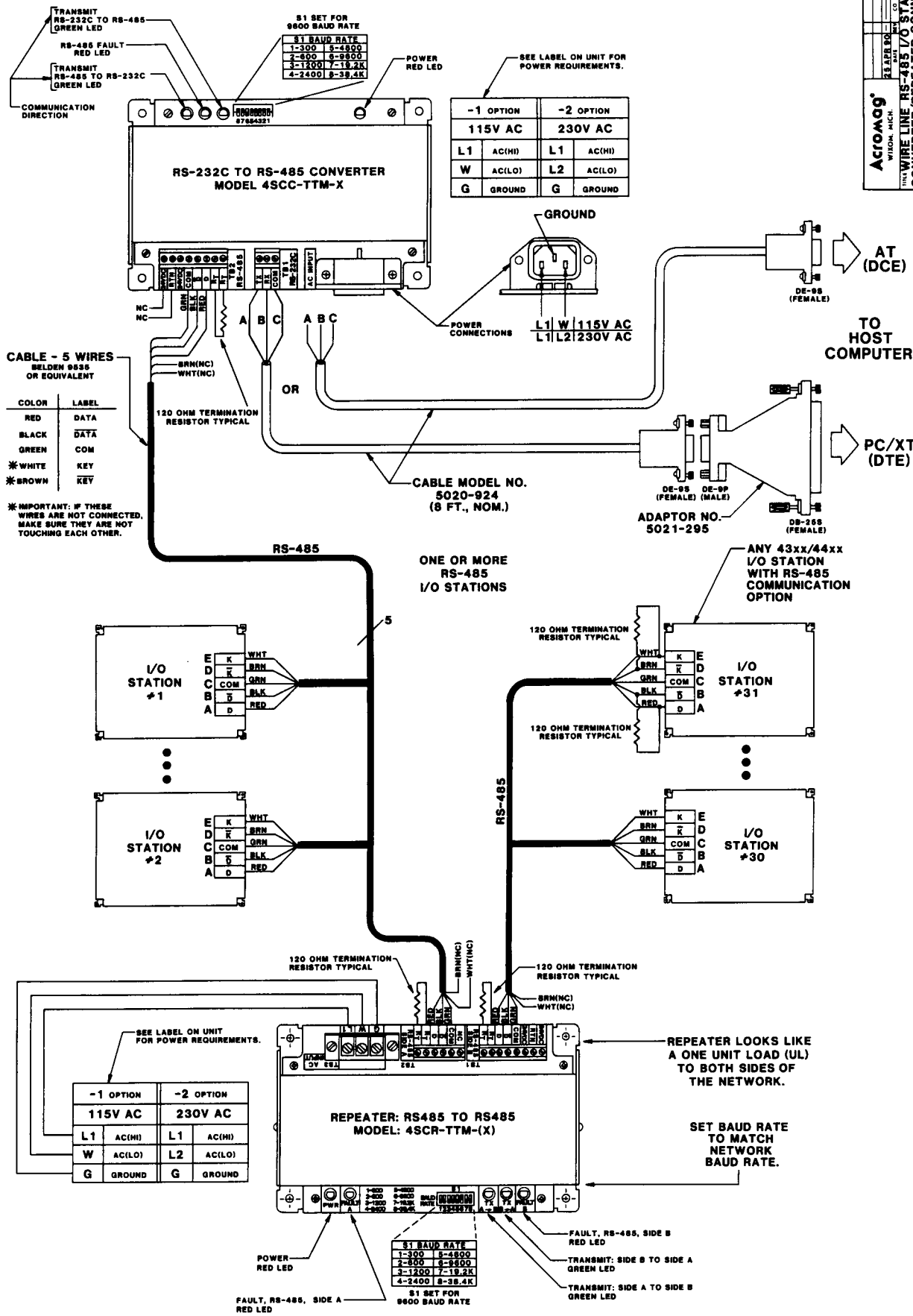

WIRE LINE/RS-485 CONVERTER/REPEATER CONNECTIONS

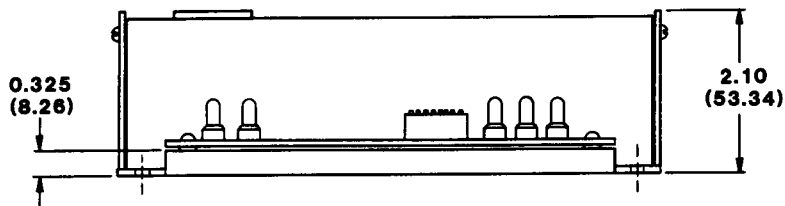
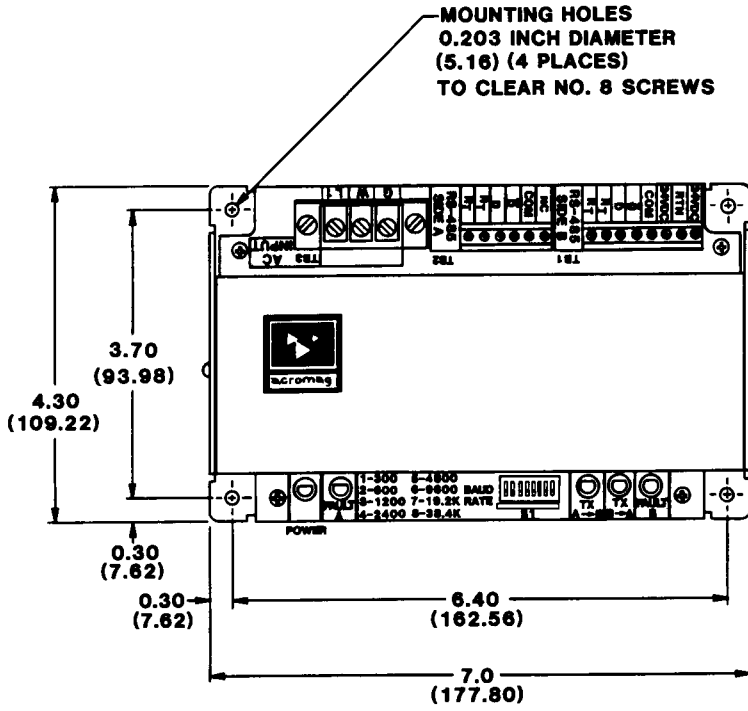

NOTE:
DIMENSIONS ARE IN INCHES
(MILLIMETERS).

REV	TO	DATE	BY	CHK'D
B	11/11/81		JK	
A	08/10/81		JK	
1	12/24/80		JK	

Acromag[®]
WIXOM, MICH.

TITLE: REPEATER: RS485 TO RS485
MOUNTING & CLEARANCE

SHEET: 1 OF 1
DRAWING: C
SERIES: 4SCR-TTM-X
REV: 4500-879