

INTRODUCTION:

Adam Tech's RFC series RF connectors are a comprehensive assortment of Radio Frequency signal connectors in standard, miniature, sub-miniature, micro miniature and surface mount styles. Included are BNC, TNC, FME, FMA, SMA, SMB, N, F, PAL, UHF, Mini-UHF, MCX, MMCX, MHF, W.FL & 1.6/5.6 coupling versions. Each has a standard industry interface. Most are ideal for applications where size and weight are important in densely populated applications. All afford excellent RF characteristics

FEATURES:

Bodies available with gold or nickel plating
 Insulators available in Teflon, Delrin, and Polypropylene
 Standard availability of 50 or 75 ohms impedance
 Through hole and SMT types for printed circuit board versions
 Male and female types available in bulkhead and cable mount versions

MATING CONNECTORS:

Adam Tech RF series connectors and all industry Standard RF connectors

SPECIFICATIONS:

Material:

Housing: Brass, Nickel plated
 Zinc diecast, Nickel plated
 Standard Insulators: Delrin, Polypropylene or Teflon
 Optional Hi-Temp Insulator: Teflon
 Contacts: Beryllium copper, Gold plated

Electrical:

Operating voltage: 150V AC max.
 Contact resistance: 5 mΩ max. initial
 Impedance: 50 or 75 ohms
 Insulation resistance: 5000 M min.
 Dielectric withstanding voltage: 1000V AC for 1 minute
 VSWR: 1.2 max
 Frequency range: 0 – 6 GHZ

Mechanical:

Engagement force: 4.5 lbs max
 Disengagement force: 2 lbs min
 Cable retention: equal to breaking strength of cable employed
 Durability: 500 cycles

Temperature Rating:

Operating temperature: -20°C to +85°C
 Soldering process temperature:
 Standard insulator: 235°C
 Hi-Temp insulator: 260°C

PACKAGING:

Anti-ESD plastic trays or bags

APPROVALS AND CERTIFICATIONS:

UL Recognized & CSA Certified,
 File no. E224053



ORDERING INFORMATION

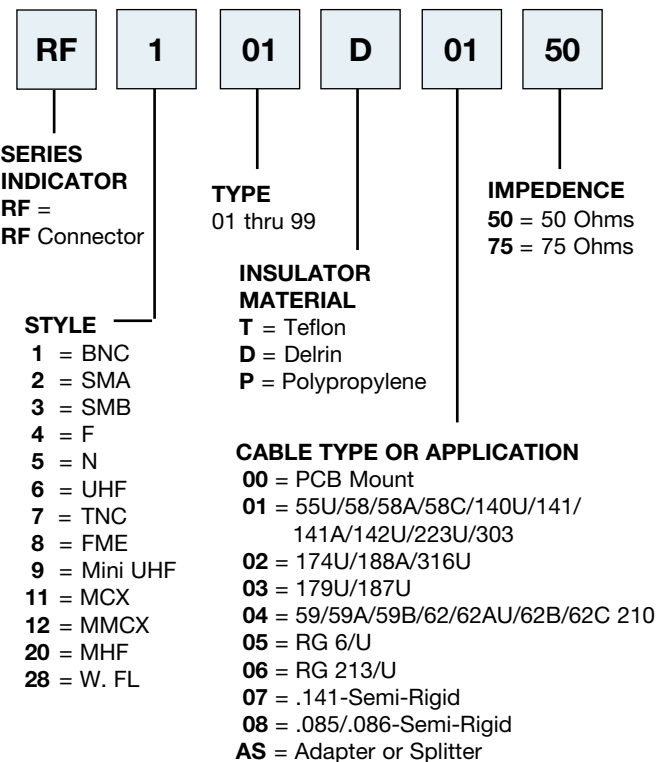

OPTIONS:

Add as suffix to basic part no.
HT = Hi-Temp insulator for hi-temp soldering processes up to 260°C
G = Gold plated body and contact

RF1 TYPE 01
BNC RIGHT ANGLE FEMALE PCB MOUNT

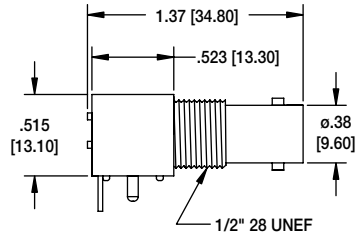
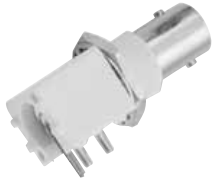

RF1-01-P-00-50

RF1 TYPE 01V
BNC STRAIGHT FEMALE PCB MOUNT

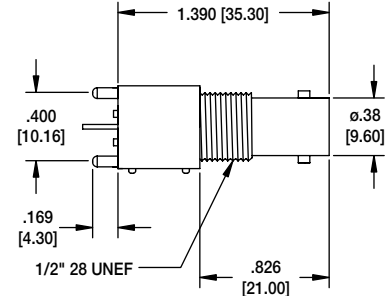

RF1-01V-P-00-75

RF1 TYPE 01A
BNC HIGH PROFILE RIGHT ANGLE FEMALE PCB MOUNT

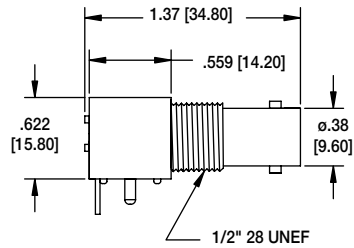

RF1-01A-P-00-50

RF1 TYPE 03
BNC MALE CRIMP

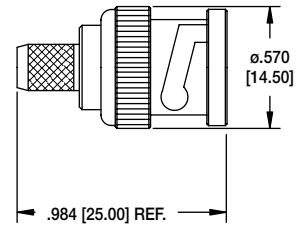

RF1-03-D-05-75

RF1 TYPE 04
BNC FEMALE BULKHEAD CRIMP

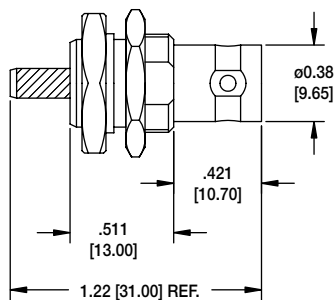
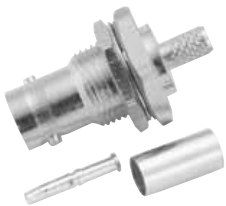

RF1-04-T-01-75

RF1 TYPE 05
BNC MALE TO BNC DOUBLE FEMALE

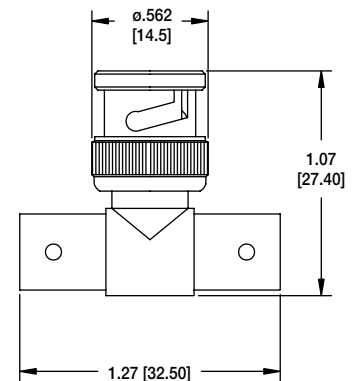

RF1-05-D-AS-75

RF1 TYPE 06
BNC MALE "Y" ADAPTER

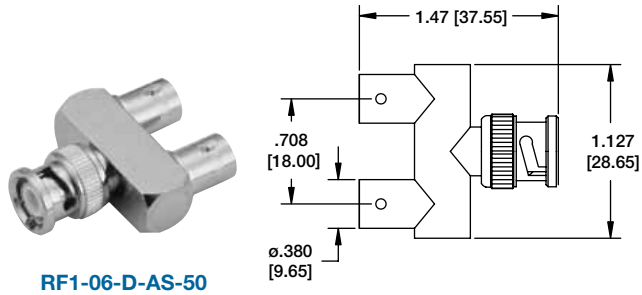

RF1-06-D-AS-50

RF1 TYPE 07
BNC FEMALE PC BOARD MOUNT

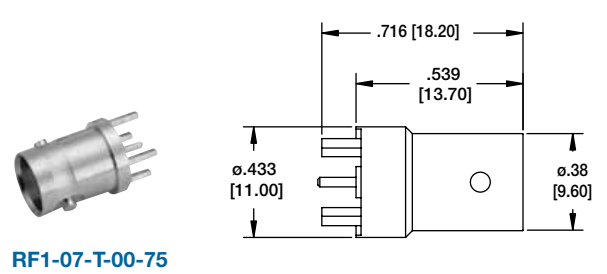

RF1-07-T-00-75

RF2 TYPE 01
SMA RIGHT ANGLE MALE CRIMP TYPE

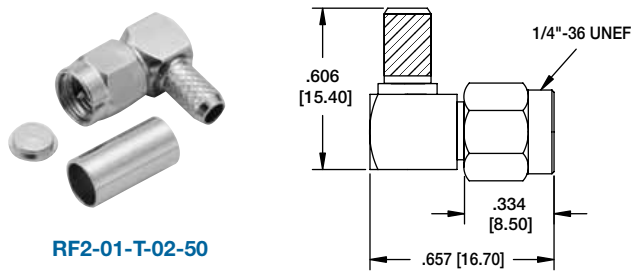

RF2-01-T-02-50

RF2 TYPE 02
SMA MALE CRIMP TYPE

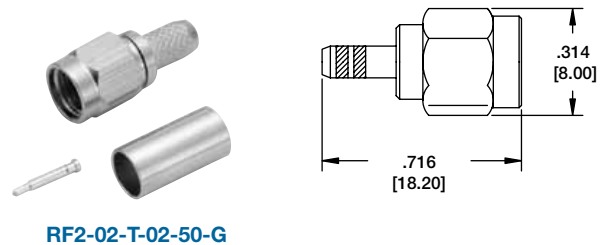

RF2-02-T-02-50-G

RF2 TYPE 03
SMA RIGHT ANGLE FEMALE PC BOARD MOUNT

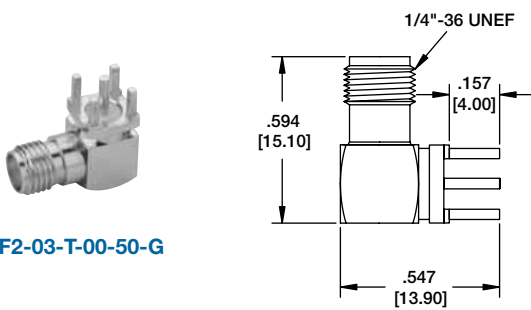

RF2-03-T-00-50-G

RF2 TYPE 04
SMA FEMALE PC BOARD MOUNT

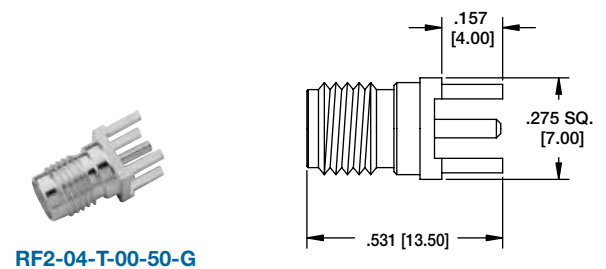

RF2-04-T-00-50-G

RF2 TYPE 05
SMA FEMALE CHASSIS CRIMP

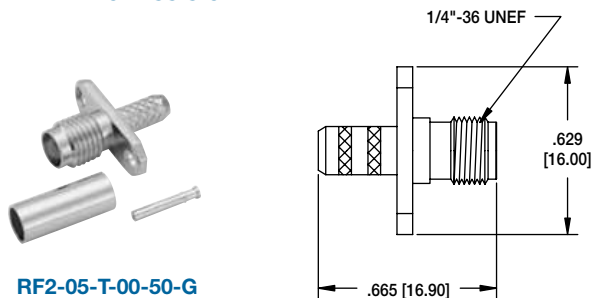

RF2-05-T-00-50-G

RF2 TYPE 06
SMA FEMALE BULKHEAD CRIMP

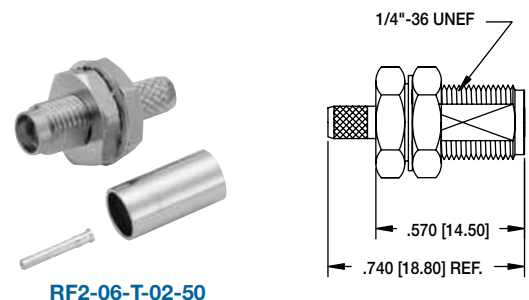

RF2-06-T-02-50

RF2 TYPE 07
SMA DOUBLE FEMALE ADAPTOR



RF2-07-T-AS-50

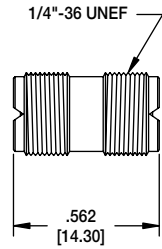

RF3 TYPE 01
SMB MALE CRIMP



RF3-01-T-01-50-G

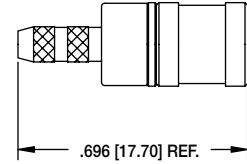

RF3 TYPE 02
SMB FEMALE CRIMP

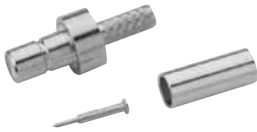

RF3-02-T-01-50-G

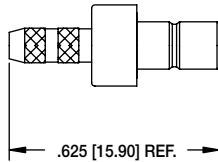

RF3 TYPE 03
SMB MALE RIGHT ANGLE CRIMP



RF3-03-T-03-75-G

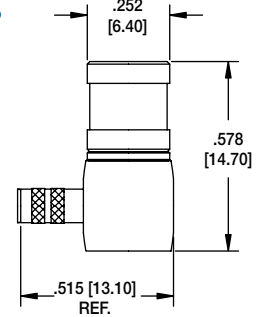

RF3 TYPE 04
SMB RIGHT ANGLE MALE PCB MOUNT



RF3-04-T-00-50-G

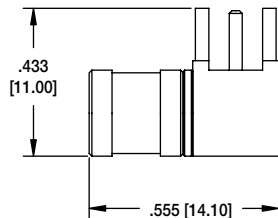

RF3 TYPE 05
SMB FEMALE PCB MOUNT



RF3-05-T-00-50-G

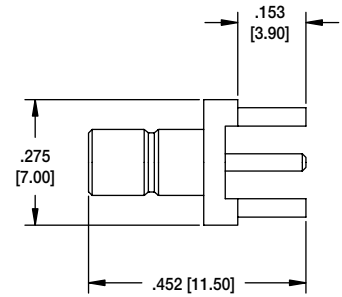

RF3 TYPE 06
SMB RIGHT ANGLE FEMALE PCB MOUNT



RF3-06-T-00-50-G

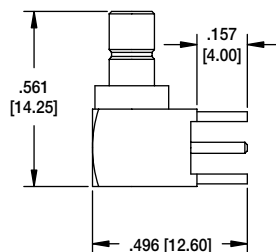

RF4 TYPE 01
F FEMALE RIGHT ANGLE PCB MOUNT



RF4-01-T-00-75

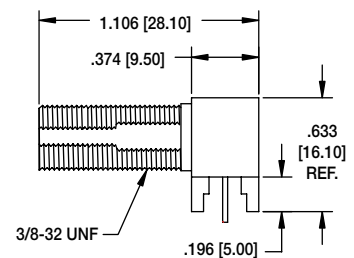

RF4 TYPE 02
F MALE TO MALE

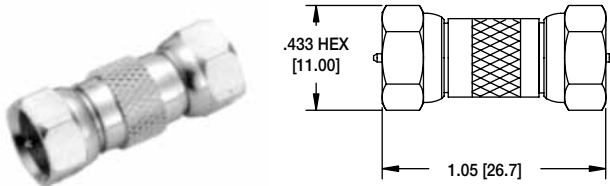

RF4-02-T-AS-75

RF5 TYPE 01
N MALE CRIMP TYPE

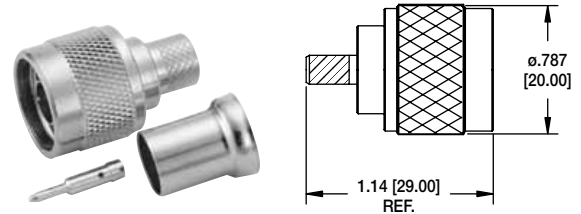

RF5-01-D-01-50

RF5 TYPE 02
N FEMALE PANEL RECEPTACLE

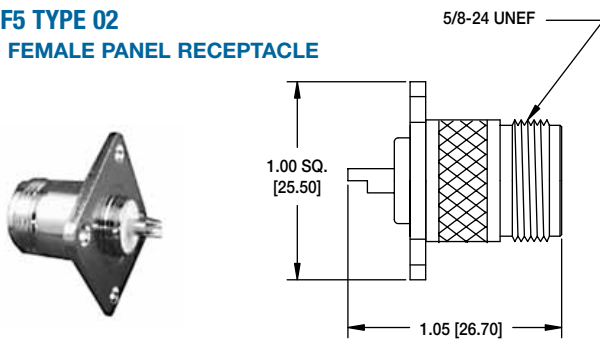

RF5-02-D-01-50

RF6 TYPE 01
UHF DOUBLE FEMALE

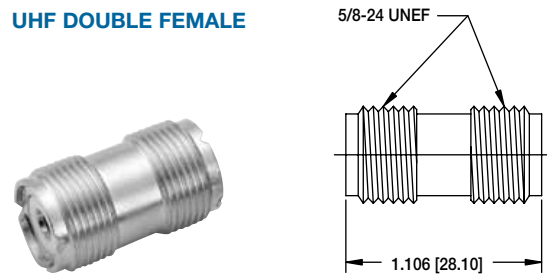

RF6-01-D-AS-50

RF7 TYPE 01
TNC MALE CRIMP

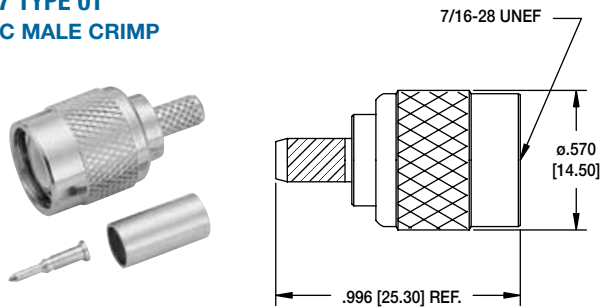

RF7-01-D-02-50

RF8 TYPE 01
FME MALE CRIMP

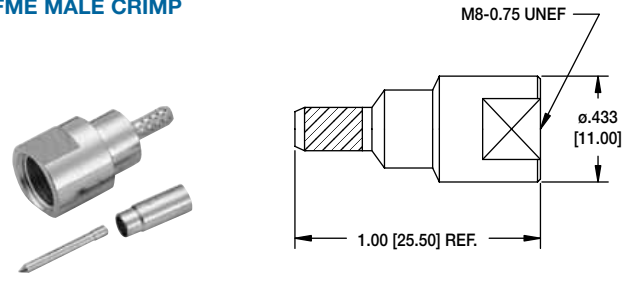

RF8-01-T-01-50-G

RF8 TYPE 02
FME MALE TO BNC MALE

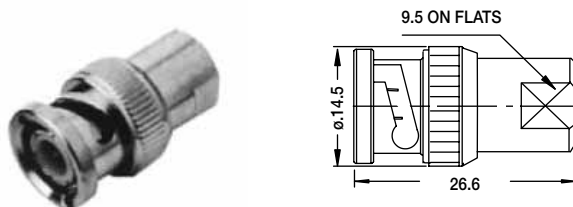





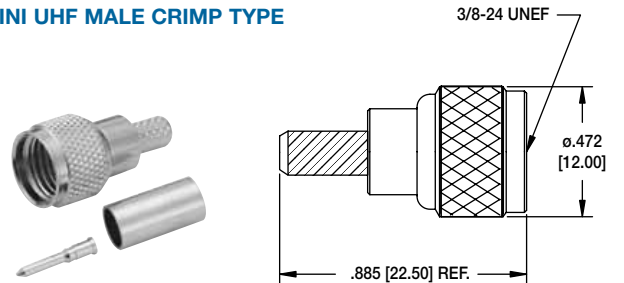



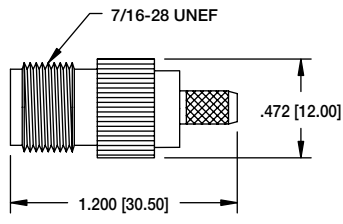

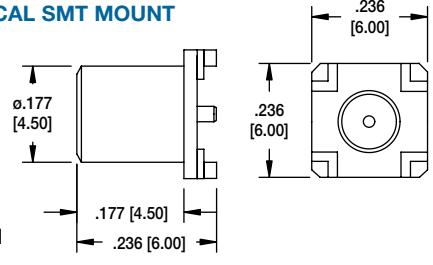

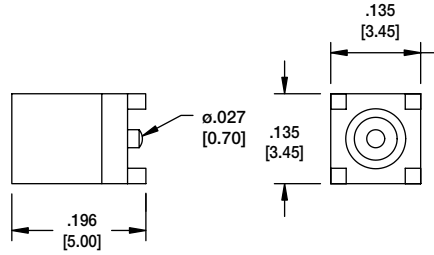
RF8-02-T-AS-50

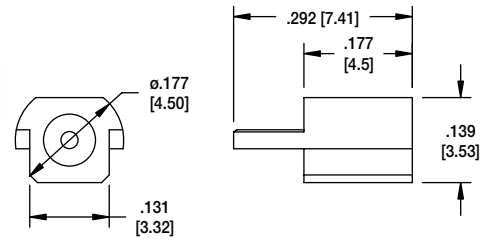
RF9 TYPE 01
MINI UHF MALE CRIMP TYPE

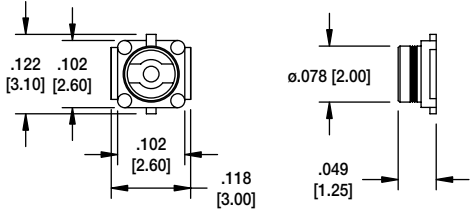
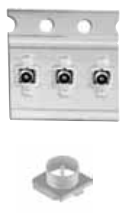
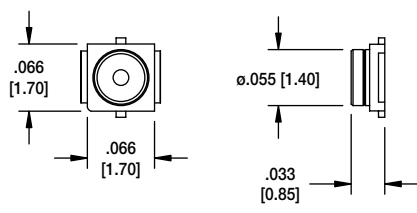

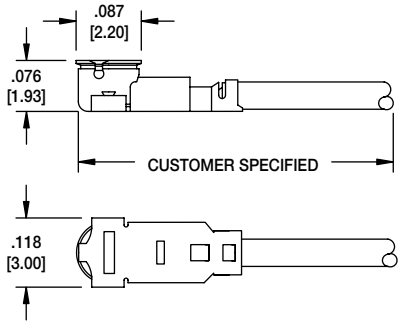
RF7-01-D-02-50

<p>RF7 TYPE 08 TNC FEMALE CRIMP</p>  <p>RF7-08-T-02-50-G</p> 	<p>RF11 TYPE 01 MCX FEMALE VERTICAL SMT MOUNT</p>  <p>RF11-01-T-00-50-G Enlarged to show detail</p> 
<p>RF12 TYPE 04 MMCX MALE VERTICAL PCB MOUNT</p>  <p>RF12-04-T-00-50-G Enlarged to show detail</p> 	<p>RF12 TYPE 05 MMCX PCB MOUNT</p>  <p>RF12-05-T-00-50-G</p> 
<p>RF20 TYPE 01 MHF SURFACE MOUNT</p>  <p>RF20-01-p-00-50-G Enlarged to show detail</p> 	<p>RF28 TYPE 01 W.FL SURFACE MOUNT</p>  <p>RF28-01-T-00-50-G Enlarged to show detail</p> 
<p>RF20 TYPE 01 CABLE ASSEMBLY MATES WITH MHF SMT CONNECTOR</p>  <p>CA# 6994-XX</p> 	<p>RF28 TYPE 01 CABLE ASSEMBLY MATES W.FL SMT CONNECTOR</p>  <p>CA# 6993-XX</p> 