



## DECS-200 Digital Excitation Control System

One DECS-200 Digital Excitation Control System can accommodate 32Vdc, 63Vdc, or 125Vdc applications up to 15Adc. This unique flexibility provides precision control of generators of virtually any size. The DECS-200 also incorporates a pulse width modulated power stage, which improves system performances in non-linear load applications.

### FEATURES

- Microprocessor-based design
  - True RMS sensing, single or three phase
  - 32Vdc, 63Vdc, and 125Vdc outputs at 15Adc
  - 0.25% Voltage Regulation Accuracy
  - Setup from front panel HMI or by PC with Windows® setup software included
  - 20 standard stability selections
  - User customizable stability selection
  - Paralleling compensation
  - Underfrequency compensation or V/Hz Ratio Limiter
  - Soft start buildup
  - Field Current Regulation Mode (Manual Mode)
  - Autotracking between operating modes and between DECS-200 units (optional)
  - Minimum Excitation Limiter (Internally generated or customizable)
  - On and off-line Maximum Excitation Limiters
  - Stator Current Limiter
  - Var and Power Factor Controllers
  - Exciter Diode Monitoring (EDM)
  - Sequence of Events Recording
  - Oscillography
- (continued on next page)

### WINDOWS® SOFTWARE

Interface for setting and communicating with Basler products  
Request DECS-200-CD

### ADDITIONAL INFORMATION

#### INSTRUCTION MANUAL

Request Publication 9360100990

**DESCRIPTION and  
SPECIFICATIONS**  
Pages 2 through 5

**FEATURES and  
FUNCTIONS**  
Pages 6 and 7

**INTERCONNECT  
DIAGRAM**  
Page 8

**FRONT, SIDE VIEWS  
and DIMENSIONS**  
Pages 9 through 11

**ORDERING**  
Page 12



## FEATURES, continued

- Voltage Matching
- Eight (8) generator protection features
- Programmable output contacts
- Front panel backlit LCD display
- Front panel mounted RS-232 and side RS-485 communications ports
- Modbus™ protocol for RS-485 input allows communications up to 4000 feet away
- <1% metering accuracy for 12 generator parameters
- Remote set point control via:
  - Contact inputs
  - Proportional control via  $\pm 10\text{Vdc}$  or 4-20mA
  - Communications inputs RS-232 (ASCII) or RS-485 (Modbus™)
- Meets C37.90.1-1989 for Surge Withstand and Fast Transient
- UL recognized, CSA certified, CE compliant
- U.S. Patent Number 5,294,879

## DESCRIPTION

The microprocessor based DECS-200 is a total excitation control system in one enclosure. It contains all the functionality necessary to limit, control, and protect a generator from operating outside of the machine's capability. An optional feature of DECS-200's sophisticated design allows the nonactive control mode within the unit to follow the active mode, permitting bumpless transfer between modes. The optional software also allows for unit-to-unit communi-

cation, permitting autofollowing and transfer between DECS-200 units. It can also communicate to a PC via the front panel RS-232 port for local programming and metering, and it can communicate via Modbus™ protocol via the side RS-485 port for communications up to 4000 feet away from the DECS-200 unit. The DECS-200 has all the features, functionality, flexibility and programmability expected from a state-of-the-art microprocessor based product.

## APPLICATIONS

The DECS-200 is an excitation control system used to control the output voltage, vars or power factor of a synchronous generator by varying or controlling the amount of dc excitation applied to the generator's exciter field. The DECS-200 is suitable for virtually any size machine.

## SPECIFICATIONS

### INPUTS

#### Control Power (style selectable)

16-60Vdc, Burden=30W. 85-132Vac, 50 or 60Hz, Burden=50VA. 90-150Vdc, Burden=30W.

#### AC Operating Power

DECS-200 Output	AC Voltage Nominal	1 or 3 Phase Power Input Range (50-500Hz)	Burden
32Vdc	60Vac	56-70Vac $\pm 10\%$	780VA
63Vdc	120Vac	100-139Vac $\pm 10\%$	1570VA
125Vdc	240Vac	190-277Vac $\pm 10\%$	3070VA

NOTE: To achieve the proper DECS-200 output voltage, the associated Operating Power must be provided. Minimum voltage buildup: 3 Vac.

#### Generator Voltage Sensing

Single-phase or three-phase line voltage, four ranges:

- 100V/50Hz nominal (85 to 127V), 120V/60Hz nominal (94 to 153V)
- 200V/50Hz nominal (170 to 254V), 240V/60Hz nominal (187 to 305V)
- 400V/50Hz nominal (340 to 508V), 400V/60Hz nominal (374 to 600V)
- 500V/50Hz nominal (425 to 625V), 600V/60Hz nominal (510 to 660V)

#### Bus Voltage Sensing

Single-phase line voltage (AC), four ranges:

- 100V/50Hz nominal (85 to 127V), 120V/60Hz nominal (94 to 153V)
- 200V/50Hz nominal (170 to 254V), 240V/60Hz nominal (187 to 305V)
- 400V/50Hz nominal (340 to 508V), 400V/60Hz nominal (374 to 600V)
- 500V/50Hz nominal (425 to 625V), 600V/60Hz nominal (510 to 660V)

## SPECIFICATIONS, continued

- Generator Current Sensing** Two ac current sensing ranges and two channel (phase) inputs:
- For metering and control: 1A and 5A.
  - For cross current compensation: 1A and 5A.
- Sensing Burden** Voltage: Less than 1VA per phase.  
Current: Less than 1VA.  
Parallel Compensation: Less than 1VA.
- Contact Switching Inputs** 11 contact switching inputs are supplied with 24Vdc to accommodate dry contacts. Contacts are as follows:
- Start
  - Stop
  - Secondary DECS Enabled (optional)
  - Unit/Parallel Operation
  - AVR Mode
  - FCR Mode
  - Var/PF Enable
  - Pre-position
  - Raise Switch
  - Lower Switch
  - Alarm Rest
- Remote Set Point Control** (Accessory Input) Two separate analog inputs for remote set point control. Typically used to accept a signal from a Power System Stabilizer. Select one from the configuration menu.
- $\pm 10\text{Vdc}$
  - 4 to 20 milliamperes

## OUTPUTS

**DC OUTPUT POWER:** One DECS-200 will accommodate 32, 63, and 125Vdc applications.

	DECS-200		DECS-200		DECS-200	
Rated Continuous Field Voltage	32 Vdc	45 Vdc*	63 Vdc	90 Vdc*	125 Vdc	180 Vdc*
Rated Continuous Field Current	15 Adc	15 Adc	15 Adc	15 Adc	15 Adc	15 Adc
Rated 10 Second Forcing Voltage*	50 Vdc	75 Vdc*	100 Vdc	150 Vdc*	200 Vdc	300 Vdc*
Rated 10 Second Forcing Current	30 Adc	30 Adc	30 Adc	30 Adc	30 Adc	30 Adc
Minimum Field Resistance	2.13 Ohm	3.0 Ohm*	4.2 Ohm	6.0 Ohm*	8.3 Ohm	12.0 Ohm*

NOTE: Above parameters with nominal RMS power input.

\*These areas indicate D.C. output levels that may be up to 50% greater than listed if:

- 1) 3 phase input power is used, or
- 2) Field current is significantly lower than that listed.

## Contact Output Ratings

Make and Break	Amps
24Vdc	8.0
48Vdc	0.7
125Vdc	0.2
120/240Vac	10.0
Carry	Amps
24/48/125Vdc	8.0
120/240Vac	10.0

Contacts are as follows:

- Watchdog
- Start/Stop
- Relay #1
- Relay #2
- Relay #3

## COMMUNICATION

There are three communication ports, two RS-232 and one RS-485:

COM0: RS-232, 9 pin, sub-D connector located on front panel and used to communicate with local computers. 1200 to 19200 baud, 8N1 full duplex, ASCII commands

COM1: RS-232, 9 pin, sub-D connector located on right side panel and used to connect primary and backup DECS-200 units. Port is only used for optional autotracking.

COM2: RS-485, located on left side panel and used to communicate with local or remote computers or other devices. 1200 to 19200 baud, 8N1 half duplex, Modbus™ protocol

## SPECIFICATIONS, continued

### REGULATION ACCURACY

AVR Mode: Voltage regulation equals  $\pm 0.25\%$  over the load range at rated power factor and constant generator frequency. Steady state stability equals  $\pm 0.1\%$  at a constant load and generator frequency. Temperature drift equals  $\pm 0.5\%$  for 0 to 50°C temperature change. Underfrequency (volts/hertz) characteristic slope from 0 to 3.0 P.U. is adjustable in 0.1 P.U. increments.

FCR Mode: Field current regulation equals  $\pm 1.0\%$  of the nominal value for 10% of the bridge input voltage change or 20% of the field resistance change.

var Mode:  $\pm 2.0\%$  of the nominal VA rating at the rated frequency.

PF Mode:  $\pm 0.02$  PF in the set point PF for the real power between 10 and 100% at the rated frequency. (e.g. -set point PF=0.80, PF regulation is from 0.78 to 0.82 PF.)

Internal autotracking(optional):  $\pm 0.5\%$  of the nominal field voltage change when transferring.

**PARALLEL COMPENSATION** Can use either reactive droop or reactive differential (cross-current) compensation. Adjustable from 0 to 30% of the rated generator voltage droop with optional 1 ampere or less or 5 amperes or less input. Line drop compensation uses this same parameter; however, it is adjustable from -30% to 0.

**FIELD OVERVOLTAGE PROTECTION** Adjustable in increments of 1.0Vdc from 1.0 to 325Vdc rated output voltage with a 0.2 to a 0.2 to 30 second inverse time delay settable in increments of 0.1 second.

**FIELD OVERCURRENT PROTECTION** Adjustable in increments of 0.1Adc steps of rated field current from 0 to 16Adc excitation current setting with an inverse time delay (ANSI C50.13).

**EXCITER DIODE MONITOR (EDM)** The DECS-200's EDM can detect open and shorted diodes on brushless generators. To do this, the DECS-200 requires the user to input the number of generator poles and the number of exciter poles (both adjustable from 0 to 20 in increments of 2). The open and shorted diode ripple threshold is adjustable from 0 to 100% of field current. The open diode protection time delay is adjustable from 10 to 60 seconds, and the shorted diode protection time delay is adjustable from 5 to 30 seconds.

**GENERATOR UNDERVOLTAGE PROTECTION** Adjustable in increments of 1Vac from 0 to 30kV sensing voltage setting with a 0.5 to 60 second time delay (ANSI C50.13) settable in increments of 0.1 sec.

**GENERATOR OVERVOLTAGE PROTECTION** Adjustable in increments of 1Vac from 0 to 30kV sensing voltage with a 0.1 to 60 second time delay (ANSI C50.13) settable in increments of 0.1 second.

**GENERATOR LOSS OF FIELD PROTECTION** Adjustable in increments of 1 kVar from 0 to 3,000Mvar, with a 0.1 to 9.9 second delay settable in increments of 0.1 second.

**LOSS OF SENSING** The loss of sensing setting for both balanced and unbalanced generator voltage is adjustable from 0 to 100% of nominal generator voltage. The protection delay is adjustable from 0 to 30 seconds in 0.1 increments.

**SOFT START** Functional in AVR and FCR with an adjustable rate of 1 to 7200 seconds in one second increments.

## SUMMING POINT and TAKEOVER TYPE

**OVEREXCITATION LIMITING** Limiter response time is less than three cycles.

### SUMMING POINT TYPE:

**On-Line High Current Level** (instantaneous) set point adjustable from 0 to 30.0Adc in 0.1Adc increments. Limiting occurs for a time period ranging from 0 to 10 sec., settable in 1 sec. increments.

**Medium Current Level** set point adjustable from 0 to 20Adc in 0.1Adc increments. Limiting occurs for a time period ranging from 0 to 120 seconds, settable in 1 sec. increments.

**Low Current Level** set point adjustable from 0 to 15Adc in 0.1Adc increments. Limiting occurs indefinitely.

## SPECIFICATIONS, continued

**Off-Line** **High Current Level** (instantaneous) set point adjustable from 0 to 30Adc in 0.1Adc increments. Limiting occurs for a time period ranging from 0 to 10 seconds, settable in 1 second increments.  
**Low Current Level** set point adjustable from 0 to 15Adc in 0.1Adc increments. Limiting occurs indefinitely.

**TAKEOVER TYPE OEL:** The Takeover OEL uses an  $I^2t$  characteristic.

**On-Line** **High Level:** High Current Level (instantaneous) set point is adjustable from 0 to 30.0Adc in 0.1 Adc increments.

**Low Level:** Low Current set point is adjustable from 0 to 15.0Adc in 0.1Adc increments. Limit occurs indefinitely.

**Time Dial** - This setting determines the inverse time curve selected.

**Off-Line** **High Level** - High current level (instantaneous) set point is adjustable from 0 to 30.0Adc in 0.1Adc increments.

**Low Level** - Low current set point is adjustable from 0 to 15.0Adc in 0.1Adc increments. Limiting occurs indefinitely.

**Time Dial** - This setting determines the inverse time curve selected.

**UNDEREXCITATION LIMITING** Adjustments based on generator ratings.

### STATOR CURRENT LIMITING

**High Level** - High current level set point adjustable from 0 to 60,000Aac in 0.1Aac increments. Limiting occurs for a time period ranging from 0 to 60 seconds, settable in 0.1 sec. increments.

**Low Level** - Low current level set point adjustable from 0 to 60,000Aac in 0.1Aac increments. Limiting occurs indefinitely.

**SEQUENCE OF EVENT RECORDING (SER)** 127 event reports stored in volatile memory (retrievable via BESTCOMS). SER triggered by: Input/Output status changes, system operating status changes, and alarm annunciations.

**OSCILLOGRAPHY** Stores 8 records. Up to 6 variables can be logged in a record. Sampling rate: 600 data points per log, pre-trigger adjustable from 0 to 599 data points, 4ms to 10sec intervals between data points (2.4sec to 6000sec. total log duration)

**MANUAL EXCITATION CONTROL** Regulates field current from 0 to 15.0A in increments of 0.1Adc.

**VOLTAGE MATCHING** Matches utility bus RMS voltage with generator output RMS voltage within  $\pm 0.15\%$  of the generator voltage

**REAL TIME CLOCK** Time displayed in either 12 hour or 24 hour format and can be selected to allow for daylight savings timer. The date is selectable for two formats: d-m-y or m/d/y. Requires control power to operate. If power is lost, the clock will need to be reset.

**SURGE WITHSTAND CAPABILITY (SWC)** IEEE C37.90.1-1989

**FAST TRANSIENT** IEEE C37.90.1-1989

**HIGH POT.** IEEE 421.3

### ENVIRONMENTAL

**Operating temperature:** -40°C to +60°C (-40°F to +140°F) **Storage temperature:** -40°C to +85°C (-40°F to +185°F)

**Salt Fog** Per MIL-STD-810E, Method 509.3 (100 hrs. of salt fog, 100 hours of drying time)

**Shock** 15 Gs in each of three mutually perpendicular planes

**Vibration** 5-26Hz: 1.2Gs; 27-52Hz: 0.914mm (.036 inch) double amplitude; 53-500Hz: 5.0Gs

**Size** 8.08" (205mm) wide x 6.76" (171mm) deep x 12.0" (304mm) high

**Weight** 14 lbs. (6.35kg)

**AGENCY** UL recognized per Std. 508; UL file number E90735; CSA certified per Std. CAN/CSA-C22.2, Number 14, CSA file number LR23131; CE compliant, EMC and LVD

## FEATURES/FUNCTIONS

### **Voltage Regulation**

The DECS-200 regulates the generator RMS voltage to within 0.25% from no-load to full-load. It does this by utilizing digital signal processing and precise regulation algorithms developed by Basler Electric, utilizing the experience gained in many years of manufacturing tens of thousands of digital voltage regulators.

### **Stability**

The DECS-200 utilizes proportional (P), integral (I) and derivative (D) stability control. DECS-200 has 20 preprogrammed stability (PID) settings for exciter field applications. This means that a standard stability setting is already available for most applications/machines. The DECS-200 has a stability range that allows for customizing the stability settings to fine tune the stability to provide optimum customized generator transient performance. Setup software contains PID selection program to assist in determining the correct PID settings. The DECS-200 provides for customizing the stability and transient performance of the Min/Max Excitation Limiter and var/PF controllers by providing additional stability adjustments.

### **Underfrequency Limiter or V/Hz Ratio Limiter**

DECS-200 is selectable for either Underfrequency Limiter or a V/Hz Ratio Limiter function. The underfrequency limiter slope can be tuned to have 0 to 3 times p.u. Volts/Hz, in 0.1Hz increments, and the corner frequency roll-off point can be set across a range of 45 to 65Hz, in 0.1Hz increments. This adjustability allows the DECS-200 to precisely match the operating characteristics of the prime mover and the loads being applied to the generator. The Volts/Hz Ratio Limiter clamps the regulation set point to prevent operation above a V/Hz level that is prescribed by the slope of the DECS-200. This feature is also useful for other potentially damaging system conditions such as a change in system voltage and reduced frequency situations that exceed the V/Hz ratio.

### **Soft Start Voltage Buildup**

Generator voltage overshoot can be harmful to the generator's insulation system if not controlled. DECS-200 has a soft start feature with a user-adjustable setting to govern the rate at which the generator voltage is allowed to build up. This prevents the generator voltage from overshooting nominal voltage levels during startup of the generator system.

### **Paralleling Compensation**

DECS-200 has provisions to parallel two or more generators using reactive droop or reactive differential compensation with the addition of an external current transformer with secondary currents of 1 or 5Aac. The current input is rated at less than 1VA. This low burden means that existing metering CTs can be used and dedicated CTs are not required.

### **Set Point Control**

DECS-200 has means for external set point adjustment of the controlling mode of operation. This eliminates the need for additional equipment like motor operated potentiometers for remote control or multiple point control for the excitation system. The operating mode's set point may be directly controlled by raise/lower contact inputs, auxiliary inputs of 4-20mA or  $\pm 10$ Vdc. The auxiliary input adjusts the operating mode across its predetermined adjustment range. The auxiliary

input can be provided from other controlling devices such as a power system stabilizer. These devices modify the operation of the DECS-200 to meet specific operating characteristics and requirements for the machine under DECS-200 control. Two more methods of set point control may be achieved via the RS-232 communication port by using the Windows® based PC software or by the RS-485 port using Modbus™ protocol. Regardless of which method of set point is used (contact inputs, auxiliary input or communications with a PC or PLC), traverse rates of all modes of operation are independently adjustable. This means an operator can customize the rate of adjustment and "feel" to meet his/her needs.

### **Pre-position Inputs**

DECS-200 provides the added flexibility of allowing a predetermined operating point for each mode of operation. With a contact input to the DECS-200, the operating mode is driven to an operating or regulation level assigned to that operation mode by the operator or user. The pre-position inputs operate in one of two modes, Maintain or Release. The Maintain mode prevents adjustment of the setpoint as long as the pre-position contact is closed. The release mode allows adjustment of the setpoint even though the pre-position is closed. This feature allows the DECS-200 to be configured for specific system and application needs.

### **Field Current Regulation Operating Mode**

DECS-200 provides a manual channel of operation called Field Current Regulation, or FCR, Mode. In this mode, DECS-200 regulates the field current generated by the internal PWM power stage. It does not rely on the sensing input to DECS-200 and is, therefore, a good source of backup excitation control when loss of sensing is detected. In this mode, control of the generator is totally dependent upon the operator to maintain nominal generator voltage as the load varies on the generator.

### **Var/Power Factor Controller Operating Mode**

DECS-200 has, as another standard feature, two modes of operation when the generator is in parallel with the utility power grid. The DECS-200 has both var and PF modes of operation. When the generator is in parallel with the utility grid, the DECS-200 can regulate the var output of the generator to a specific var level magnitude or it can vary the var output of the generator to maintain a specific power factor as the kW load varies on the generator.

### **Maximum Excitation Limiters**

Overexcitation limiting (OEL) operates in all modes except FCR mode. OEL senses the field current output of the voltage regulator or static exciter and limits the field current to prevent field overheating. In FCR mode, the DECS-300 only announces that all conditions for OEL are fulfilled and does not provide limiting. The DECS-200 provides two types of overexcitation: Summing Point and Takeover.

### **Summing Point Type OEL**

Three OEL current levels are defined for on-line operation. They are high, medium, and low. The generator can operate continuously at the low OEL current level and for programmed times at the high and medium OEL current levels. Two OEL current levels are defined for off-line (main breaker open) operation. They are high and low. The generator can operate continuously at the low OEL current level and for a programmed time at the high OEL current level.

## FEATURES/FUNCTIONS, continued

### Takeover Type OEL

The field current level at which limiting occurs is determined by an inverse time characteristic. Two current levels and a time dial setting are defined for the takeover-style OEL limiter. Separate curves may be selected for on-line and off-line operation. If the system enters an overexcitation condition, the field current is limited and made to follow the selected curve. The selection of on-line or off-line OEL levels/curves is determined by an OEL option selection.

### Minimum Excitation Limiter

The minimum excitation limiter limits the amount of excitation supplied to the field of the generator from dropping below unsafe operating levels. This prevents the machine from possibly slipping poles and from damaging the machine. It limits the amount of vars being absorbed by the machine, based on user-definable settings. An internally generated Underexcitation Limiting (UEL) curve can be utilized based on a var level at 0kW, or a customizable 5 point UEL curve can be selected to match specific generator characteristics.

### Stator Current Limiter

The stator current limiter (SCL) senses the level of stator current and limits it to prevent stator overheating. The SCL operates in all modes except FCR. In FCR mode, the DECS-200 only announces that a stator overcurrent condition exists; it does not provide current limiting. Two SCL current levels are provided: high and low. The generator can operate continuously at the low SCL level but only for a programmed time at the high SCL level.

### Internal Autotracking Between DECS-200 Operating Modes

DECS-200 is an intelligent device that can provide autotracking (autofollowing) of the controlling mode by the non-controlling modes. This allows the operator to initiate a controlled, bumpless transfer of the DECS-200 operating modes, causing minimum amounts of line disturbance for the power system. This feature can be used in conjunction with a set of protective relays to initiate a transfer to a backup mode of operation, such as FCR mode, upon the detection of a system failure or fault, i.e., loss of sensing.

### External Autotracking between Dual DECS-200 Units (Optional)

A DECS-200 can also follow (autotrack) a second DECS-200 unit. The second DECS-200 is put into a specific operating mode and follows the excitation level of the first. In the unlikely event of a failure of the first DECS-200, protective relays can initiate a transfer of control from the first to the second DECS-200.

### Protective Functions

There are several protection functions built into the DECS-200 unit. These functions may be used as backup to the primary protection relays and can be assigned programmable output contacts via the PC software. The protection features offer fully adjustable tripping levels and time delays. The protective features are as follows:

- Generator Overvoltage
- Generator Undervoltage
- Field Overvoltage
- Field Overcurrent
- Watchdog Timer
- Loss of Sensing
- Loss of field
- EDM Exciter Diode Monitor

### Sequence of Events Recording (SER)

A sequence of event report (SER) is a very powerful tool when reconstructing the exact timing of an event or disturbance. The DECS-200 monitors its contact inputs and outputs for a change of state, system operation changes, and alarm conditions. If any of these events occurs, the DECS-200 will log that event with a date and time stamp. Date and time stamping of the event allows the user to recreate a chain of events in the sequence in which they occurred. The DECS-200 can store 127 events in volatile memory, and those events are retrievable using BESTCOMS.

### Oscillography (See Figure 6)

The data recording feature can record up to eight (8) oscillographic records stored in volatile memory. The user can select up to six (6) variables to be monitored when triggered by the DECS-200 BESTCOMS, a Logic Trigger, or a Level Trigger. Variables that can be selected are: generator voltage, current (single phase), frequency, kW, Power Factor, exciter field voltage, and current.

The user can utilize the DECS-200 BESTCOMS to trigger and save a record of a voltage step response during commissioning. Once commissioned, a logic trigger or level trigger can be used to activate the data recorder to capture the occurrence for review at a later time. DECS-200 alarms can also be used to start the data recorder. When an alarm condition occurs, an oscillographic record can be stored. A level trigger will initiate a record to be saved when a variable exceeds a predetermined setting. An example of this is when the exciter field current exceeds a predetermined setting.

The oscillographic records are recorded in accordance with the IEEE Standard Common Format for Transient Data Exchange (COMTRADE). Basler Electric can provide BESTWAVE, a COMTRADE viewer, which is a program that will allow the user to view the oscillography records saved by the DECS-200.

### Communications

DECS-200 comes complete with Windows® based PC software. This software makes the programming and customization of the DECS-200 easy and fast. The software comes with a PID selection program that allows the user to select stability settings quickly and easily in a user-friendly format. The PC software has a special monitoring function that allows the user to view all settings, a metering screen for viewing all machine parameters, and a control screen for remote control of the excitation system.

The RS-485 port supports Modbus™ communications protocol. This is an open protocol with all registers and operating instructions available in the instruction manual, to make it simple for the user to develop custom communications software.

### Password Protection

All DECS-200 parameters are viewable via the front panel LCD display, the PC software or via Modbus™ without the need of a password. If the user wishes to change a setting, the proper password must be entered to allow access to the parameter. Two levels of password protection exist, one for global access of all parameters and one for a limited amount of access to parameters normally associated with operator control.

# CONNECTIONS

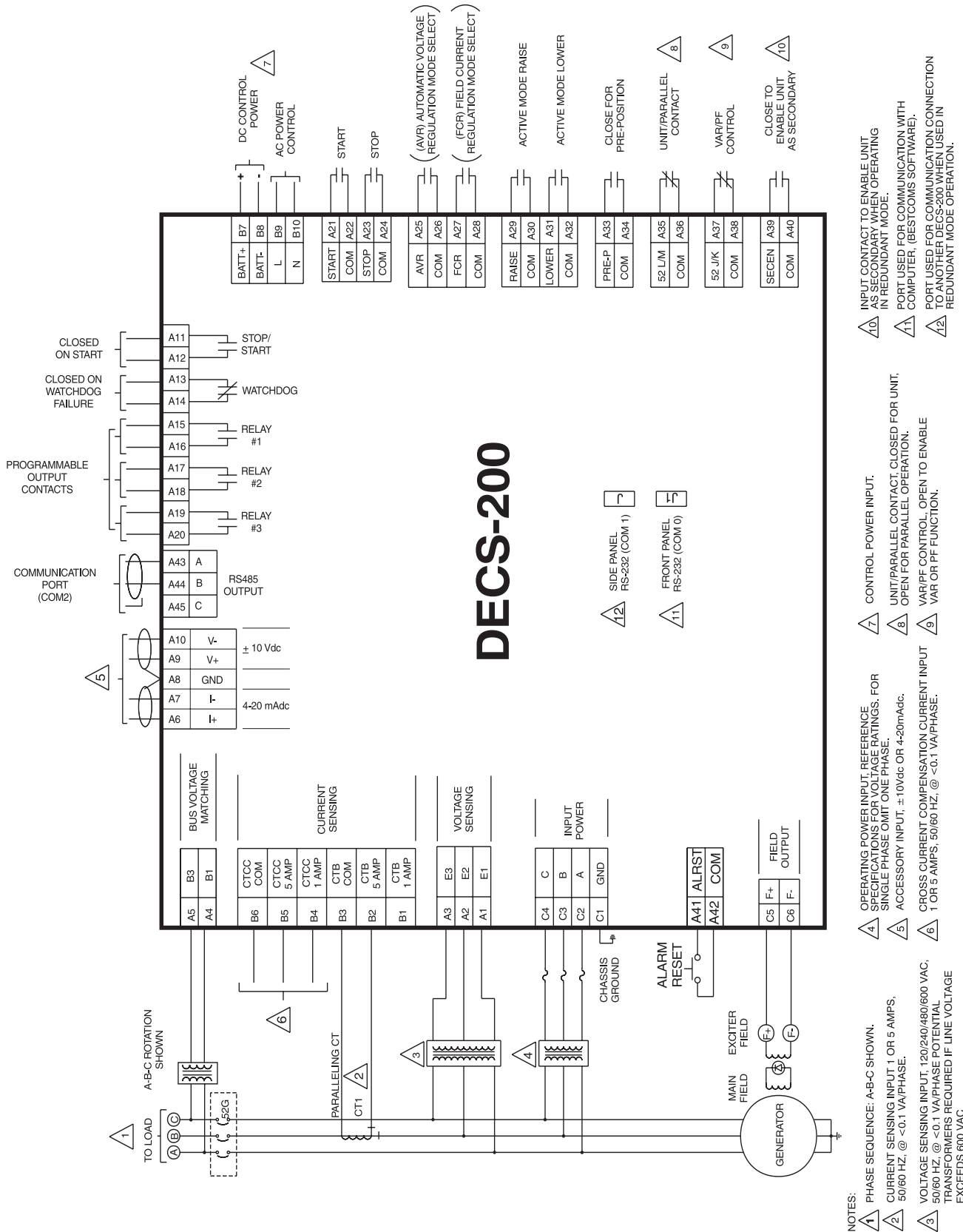

Figure 1 - Typical AC Connection Diagram



## FRONT and SIDE PANEL VIEWS

The front panel HMI (Human Machine Interface) is composed of several elements, including a backlit LCD screen, six (6) pushbuttons and six (6) LEDs. The LCD is the primary interface because it conveys the majority of the information between the DECS-200 and the user/operator. Front panel pushbuttons allow the user to view menu screens and modify the various screen settings and operating conditions. The LEDs annunciate their respective states.

- A) 64x128 pixel graphic LCD with backlighting. Primary source for receiving information from the DECS or when locally programming settings. Displays operations, set points, loop gains, metering, protection functions, system parameters and general settings.
- B) Pre-Position LED – Turns ON at the predefined setting (within the limits of the setpoints) of the current mode.
- C) Lower Limit LED – Turns ON at the minimum set point value of the current (active) mode.
- D) Upper Limit LED – Turns ON at the maximum set point value of the current mode.
- E) Scrolling Pushbuttons – Scrolls UP/DOWN/LEFT/RIGHT through the menu tree or when in the EDIT mode, the LEFT/RIGHT scrolling pushbuttons select the variable to change and the UP/DOWN scrolling pushbuttons change the variable.
- F) Reset Pushbutton – Cancels editing sessions and can be used as a quick-access to the metering screen.
- G) Serial Port COM0 – D-type 9 pin connector. This port is dedicated to RS-232 (ASCII commands) communication with a computer terminal or PC running a terminal emulation program such as BESTCOMS™.
- H) Edit Pushbutton – Enables settings changes. When the EDIT pushbutton is first pushed, an LED on the pushbutton turns ON to indicate the edit mode is active. When changes are complete (using the scrolling pushbuttons) and the EDIT pushbutton is pushed again, the LED turns OFF, indicating the changes are saved. If changes are not completed and saved within five minutes, the edit mode is exited without saving changes.
- I) Null Balance LED – Turns ON when the inactive modes (AVR, FCR, var, or PF) match the active mode.
- J) Internal tracking LED – All inactive modes (AVR, FCR, var, or PF) track the active mode to accomplish the bumpless transfer when changing active modes.

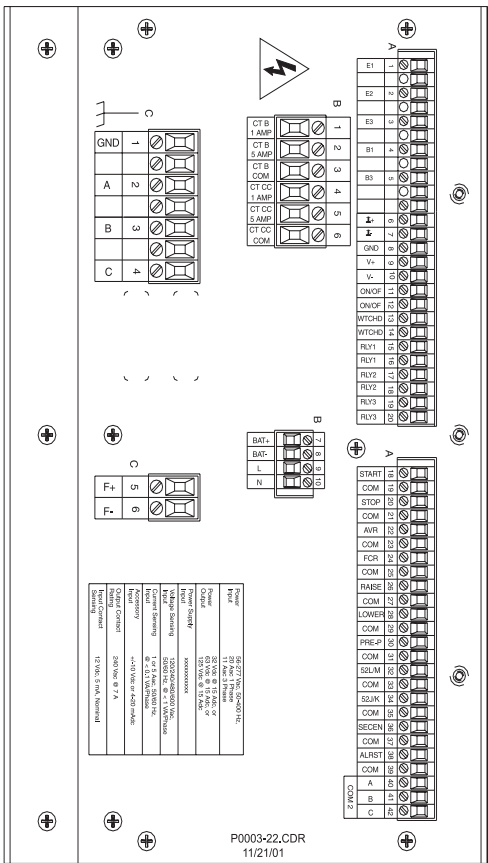
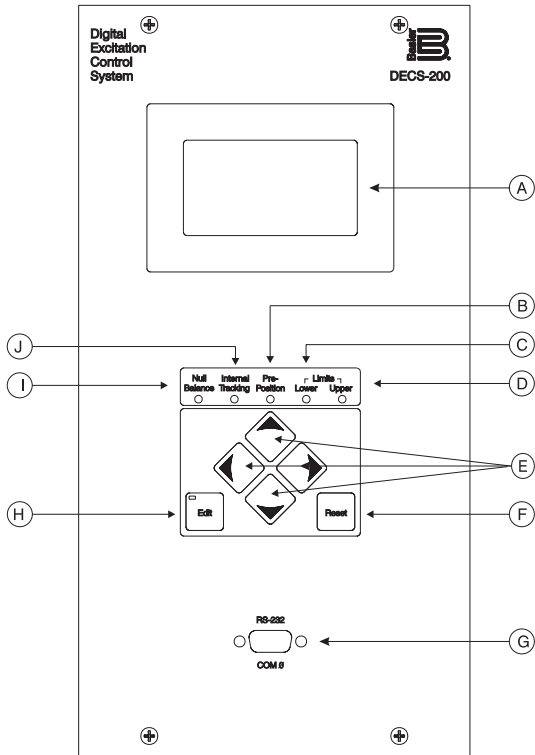
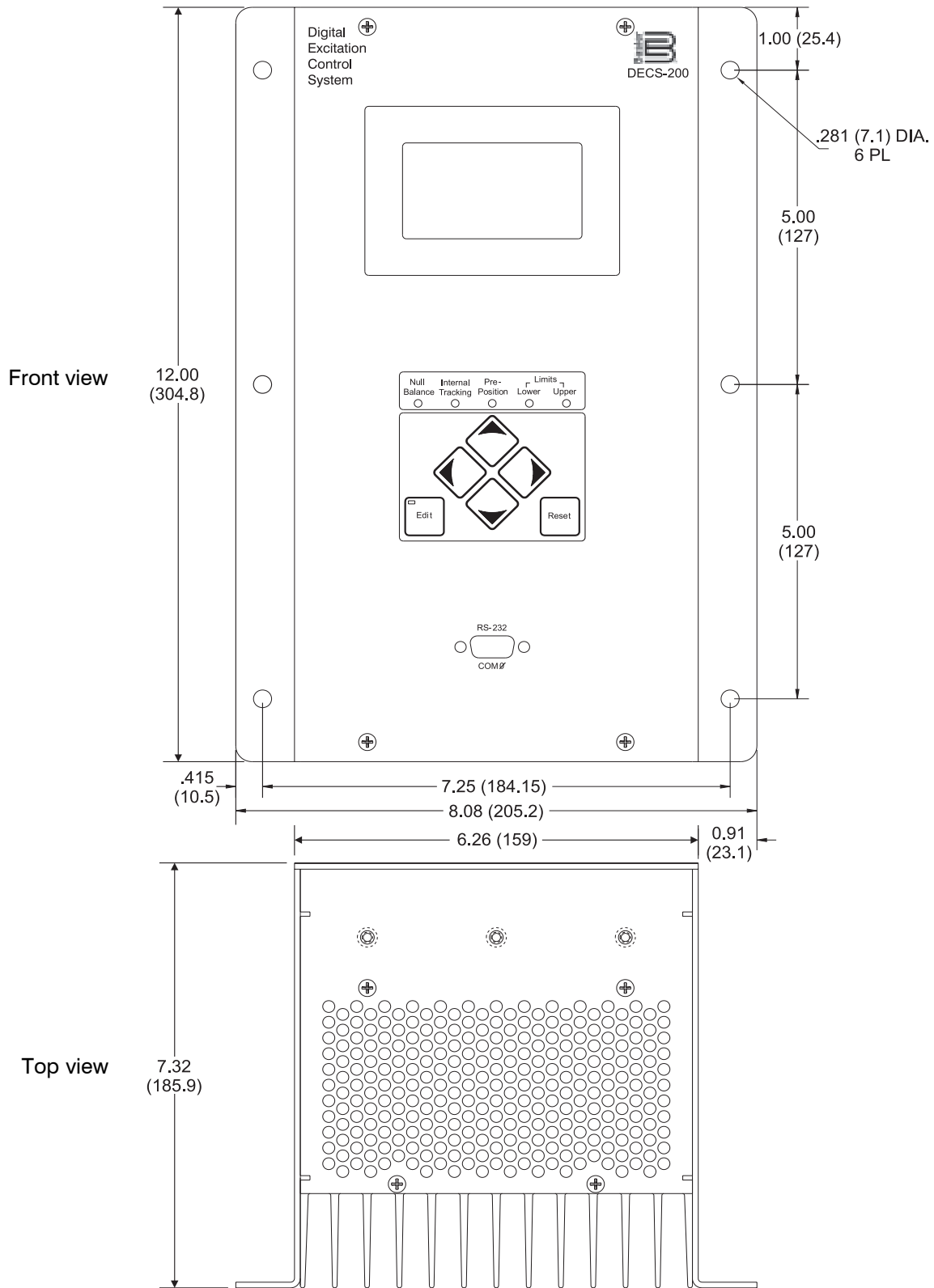

Figure 2 - Side Panel View

## DIMENSIONS



**Figure 3 - Dimensions**

# ACCESSORIES

- Front panel mounting bracket, Basler P/N 9360107100. See Figure 4.
- Interconnection cable for dual DECS-200 applications, Basler P/N 9310300032.
- Control Power Isolation Transformer, Basler P/N BE31449-001. Isolation required on AC control power input when dual control power sources are used.
- DECS Freewheeling Diode Module required in dual DECS-200 applications, Basler P/N 9293600101.
- Inrush Current Reduction Module required when operating power of the DECS-200 is fed via a station service source.
- The RDP-300 Remote Display Panel is a human-machine interface (HMI) used with a single or dual DECS-200 to provide remote control, to view metered quantities, and to provide annunciation of digital controller status and alarms. The RDP-300 uses a touch-sensitive six inch diagonal monitoring screen with RS-485 Modbus communication protocol, which may be located up to 4000 feet away from the DECS-200 controller(s).

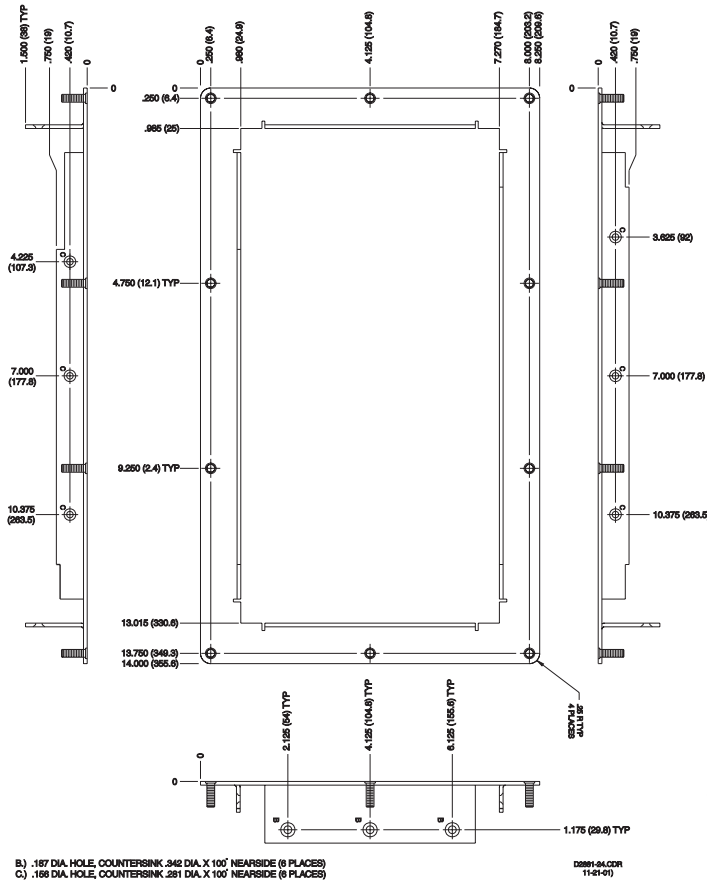

**Figure 5 - Front Panel Cutout Dimensions  
 (Requires mounting bracket shown in  
 Figure 4.)**

**Figure 4 - Front Panel Mounting Bracket,  
 P/N 9360107100**

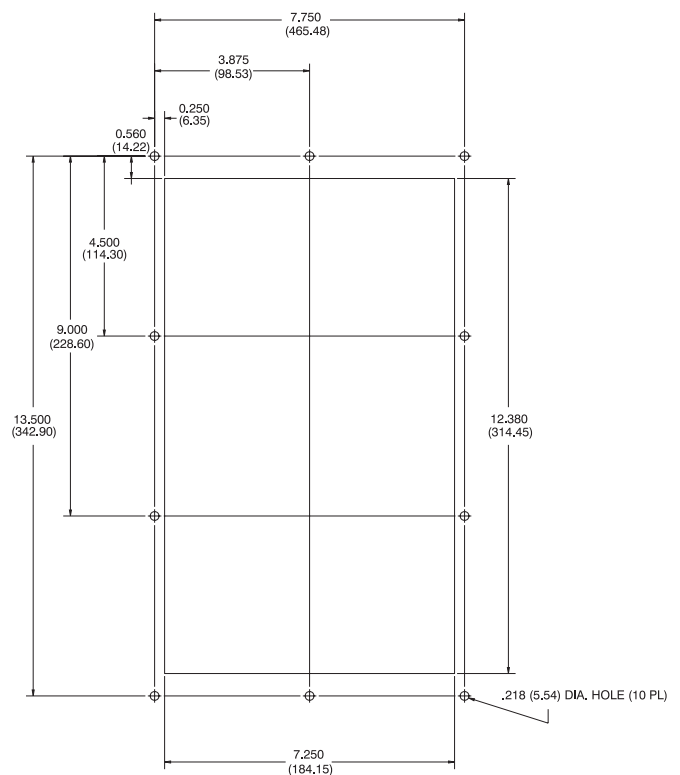

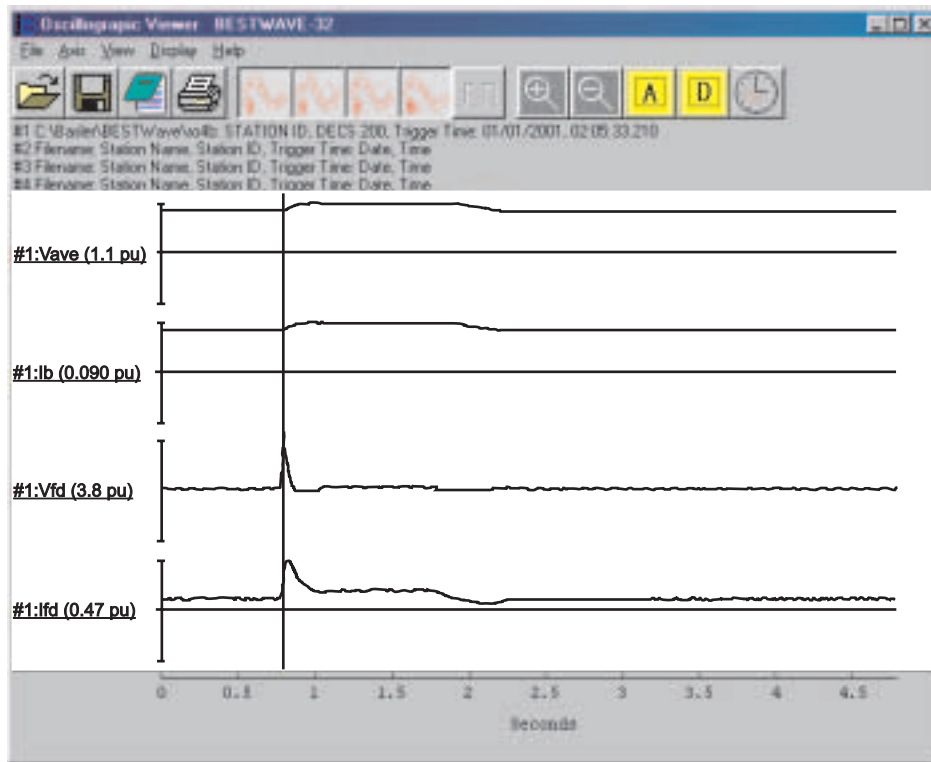

P0007-18.CDR  
08/10/01

Figure 6 - BESTwave Oscillography

## HOW TO ORDER

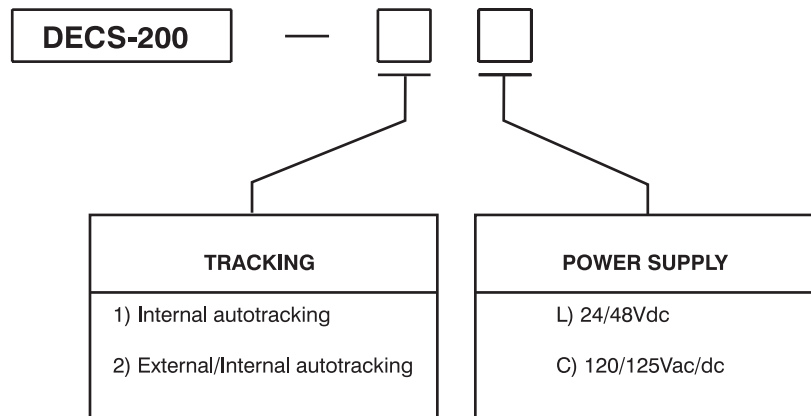

# B Basler Electric



P.A.E. Les Pins, 67319 Wasselonne Cedex FRANCE  
Tel +33 3.88.87.1010 Fax +33 3.88.87.0808  
e-mail: beifrance@basler.com

Route 143, Box 269, Highland, Illinois U.S.A. 62249  
Tel +1 618.654.2341 Fax +1 618.654.2351  
e-mail: info@basler.com

1300 North Zhongshan Road, Wujiang Economic Development Zone  
Suzhou, Jiangsu Province, PRC 215200  
Tel +86(0)512 6346 1730 Fax +86(0)512 6346 1760  
e-mail: beichina@basler.com

[www.basler.com](http://www.basler.com)