

Super-mini Signal Conditioners Mini-M Series

PULSE ISOLATOR

Functions & Features

- Galvanically isolates pulse rate signals
- Input frequency = output frequency
- Various outputs (relay, open collector and voltage pulses)
- CE marking
- UL approval for 24 V DC power

Typical Applications

- Isolating field pulse signals in order to reduce noises
- Changing e.g. dry contact signal to e.g. 5 V signals

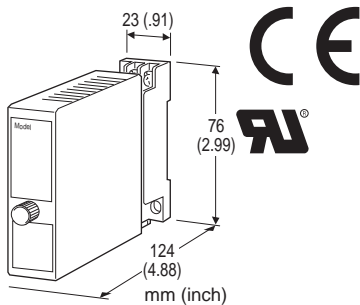

MODEL: M2PP-[1][2][3]-[4][5]

ORDERING INFORMATION

- Code number: M2PP-[1][2][3]-[4][5]
- Specify a code from below for [1] through [5].
(e.g. M2PP-33N-M2/CE/Q)
- Specify the specification for option code /Q
(e.g. /C01/S01)

[1] INPUT

- 1: Mechanical contact (max. frequency 30 Hz)
- 2: Open collector (max. frequency 10 kHz)
- 3: Voltage pulse (max. frequency 10 kHz)

[2] OUTPUT

- 1: Low frequency open collector (max. frequency 30 Hz)
 - 2: High frequency open collector (max. 10 kHz)
 - 3: 5 V pulse (max. frequency 10 kHz)
 - 4: 12 V pulse (max. frequency 10 kHz)
 - 5: 24 V pulse (max. frequency 10 kHz)
 - 6: Mercury relay contact (max. frequency 30 Hz)
- (Select '/N' for 'Standards & Approvals' code)
(Not conformed to RoHS Directive)

[3] OUTPUT LOGIC

- N: The same as the input
R: Inverted

[4] POWER INPUT

AC Power

M: 85 – 264 V AC (Operational voltage range 85 – 264 V, 47 – 66 Hz)

(Select '/N' for 'Standards & Approvals' code.)

M2: 100 – 240 V AC (Operational voltage range 85 – 264 V, 47 – 66 Hz)

('UL' is not selectable for 'Standards & Approvals' code.)

DC Power

R: 24 V DC

(Operational voltage range 24 V \pm 10 %, ripple 10 %p-p max.)

R2: 11 – 27 V DC

(Operational voltage range 11 – 27 V, ripple 10 %p-p max.)

(Select '/N' for 'Standards & Approvals' code.)

P: 110 V DC

(Operational voltage range 85 – 150 V, ripple 10 %p-p max.)

('UL' is not selectable for 'Standards & Approvals' code.)

[5] OPTIONS (multiple selections)

STANDARDS & APPROVALS (must be specified)

/N: Without CE or UL

/CE: CE marking

/UL: UL approval (CE marking)

OTHER OPTIONS

blank: none

/Q: Option other than the above (specify the specification)

(UL not available)

SPECIFICATIONS OF OPTION: Q (multiple selections)

COATING (For the detail, refer to M-System's web site.)

/C01: Silicone coating

/C02: Polyurethane coating

/C03: Rubber coating

TERMINAL SCREW MATERIAL

/S01: Stainless steel

GENERAL SPECIFICATIONS

Construction: Plug-in

Connection: M3 screw terminals (torque 0.8 N·m)

Housing material: Flame-resistant resin (black)

Isolation: Input to output to power

Frequency range: Input and output are the same.

Chattering protection: Filter provided for mechanical contact input

Input pulse sensing: DC coupled

INPUT SPECIFICATIONS

Excitation: 12 V DC @30 mA; shortcircuit protection

- **Open Collector**

Maximum frequency: 10 kHz

Pulse width time requirement: 10 μ sec. min. for ON and OFF

Sensing: Approx. 12 V DC @3 mA

ON/OFF level: $\leq 200 \Omega$ for ON, $\geq 100 \text{ k}\Omega$ for OFF

- **Mechanical Contact**

Maximum frequency: 30 Hz

Pulse width time requirement: 10 msec. min. for ON and OFF

Sensing: Approx. 12 V DC @3 mA

ON/OFF level: $\leq 200 \Omega$ for ON, $\geq 100 \text{ k}\Omega$ for OFF

- **Voltage Pulse**

Maximum frequency: 10 kHz

Pulse width time requirement: 10 μ sec. min. for high and low levels

Waveforms: Square or sine

Hi/Lo level: 2 - 50 V for high level; ≤ 1 V for low level

Input impedance: 10 k Ω min.

OUTPUT SPECIFICATIONS

- **Low Frequency Open Collector:**

50 V DC @100 mA (resistive load)

Maximum frequency: 30 Hz

Timer: Limits within 75 \pm 25 msec.

ON time for output logic non-inverted

OFF time for output logic inverted

Saturation voltage: 0.5 V DC

- **High Frequency Open Collector:**

50 V DC @100 mA (resistive load)

Maximum frequency: 10 kHz

Saturation voltage: 0.5 V DC

- **Voltage Pulse**

Maximum frequency: 10 kHz

High level: Rating (5, 12 or 24 V) ± 10 %

Low level: ≤ 0.5 V

Load resistance:

$\geq 250 \Omega$ for 5 V

$\geq 600 \Omega$ for 12 V

$\geq 1200 \Omega$ for 24 V

- **Mercury Relay Contact**

Maximum frequency: 30 Hz

Timer: Limits within 75 \pm 25 msec.

ON time for output logic non-inverted

OFF time for output logic inverted

Rated load: 132 V AC @200 mA ($\cos \phi = 1$)

30 V DC @200 mA (resistive load)

Maximum switching voltage: 350 V AC or 500 V DC

Maximum switching current: 200 mA AC or 300 mA DC

Maximum switching power: 26 VA or 6 W

Relay life: $\geq 5 \times 10^8$ cycles, mechanical

$\geq 5 \times 10^7$ cycles, electrical

INSTALLATION**Power Consumption**

- **AC Power input:**

Approx. 3 VA at 100 V

Approx. 4 VA at 200 V

Approx. 5 VA at 264 V

- **DC Power input:** Approx. 3 W

Operating temperature: -5 to +55°C (23 to 131°F)

Operating humidity: 30 to 90 %RH (non-condensing)

Mounting: Surface or DIN rail

Weight: 150 g (0.33 lbs)

PERFORMANCE

Insulation resistance: $\geq 100 \text{ M}\Omega$ with 500 V DC

Dielectric strength: 2000 V AC @1 minute (input to output to power to ground)

STANDARDS & APPROVALS**CE conformity:**

EMC Directive (2004/108/EC)

EN 61000-6-4 (EMI)

EN 61000-6-2 (EMS)

Low Voltage Directive (2006/95/EC)

EN 61010-1

Installation Category II

Pollution Degree 2

Max. operating voltage 300 V

Input or output to power: Reinforced insulation

Input to output: Basic insulation

Approval:

UL nonincendive Class I, Division 2,

Groups A, B, C, and D hazardous locations (UL 1604)

UL general safety requirements

(UL 61010B-1)

OUTPUT LOGIC

INPUT TYPE	PULSE LOGIC	INPUT	VOLTAGE PULSE OUTPUT	OPEN COLLECTOR or RELAY OUTPUT
Voltage Pulse Input	Non Inverted	H L	H L	OFF ON
	Inverted	H L	H L	OFF ON
Mechanical Contact Open Collector	Non Inverted	OFF ON	H L	OFF ON
	Inverted	OFF ON	H L	OFF ON

DIMENSIONS unit: mm (inch)

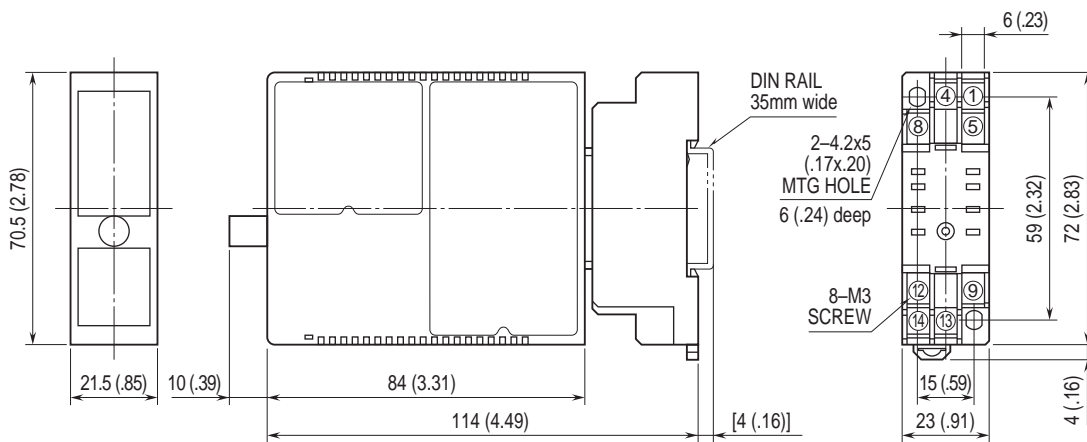

• When mounting, no extra space is needed between units.

SCHEMATIC CIRCUITRY & CONNECTION DIAGRAM

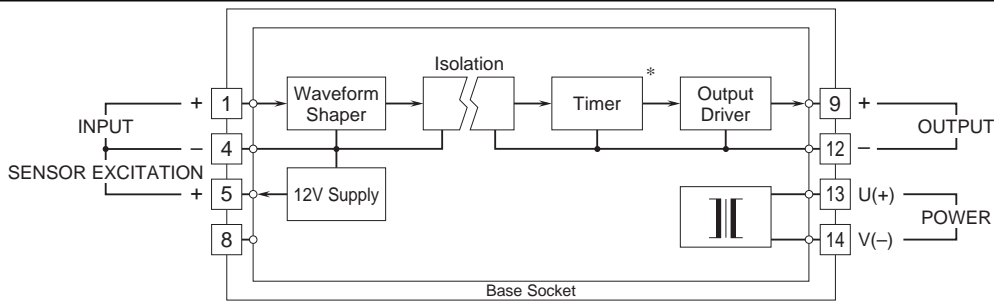

*Low freq. open collector and mercury relay output only.

Input Connection Examples

■ Mechanical Contact or Open Collector

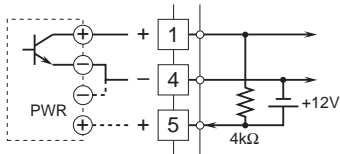

■ Voltage Pulse

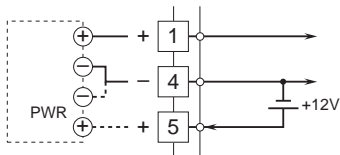

Output Connection Examples

■ Open Collector

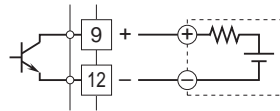

■ Voltage Pulse

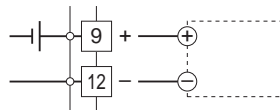

■ Relay
• AC Powered

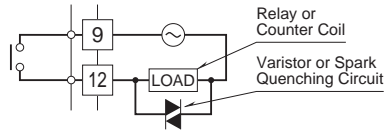

• DC Powered

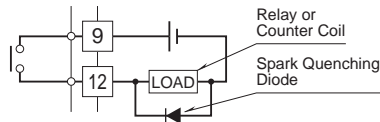

Specifications are subject to change without notice.