

Summit X480 Series



The Summit X480 series switch is a versatile, high-end Ethernet switch for data center, enterprise aggregation, and Carrier Ethernet deployments. Summit X480 helps optimize application performance for a variety of network deployments with its rich features and high scalability.

Summit X480 provides high density for Gigabit Ethernet in a small 1RU form factor for up to 48 ports in one system and 384 ports in a stacked system using backward compatible SummitStack™, high-speed SummitStack128 running at 128 gigabits per second, or SummitStack-V, which utilizes 10 GbE ports as stacking ports, enabling the use of standard cabling and optics technologies used for 10 GbE. Summit X480 also offers 10 Gigabit Ethernet connectivity for up to six ports in one system and 16 ports in a stacked system with the industry-standard XFP interface.

For emerging demands from voice/data convergence and storage, Summit X480 provides highly scalable Layer 2/3 switching and MPLS/H-VPLS by supporting up to 512K Layer 2 MAC addresses or 512K IPv4 Longest Prefix Match routing tables. Summit X480 enables data center, enterprise and Carrier Ethernet aggregation and core backbone deployment in AC-powered and DC-powered environments.

Summit X480 simplifies network operation with the ExtremeXOS modular OS, available across a wide range of Extreme Networks® Ethernet switches. The ExtremeXOS operating system provides high availability and simplicity with one OS everywhere in the network.

Target Applications

- Top-of-rack switch for servers in enterprise data centers
- High-performance core switch for a small network
- High-performance gigabit aggregation switch in a traditional three-tiered network
- Carrier Ethernet network switch that can aggregate connectivity for first mile access concentrators such as DSLAM and CMTS

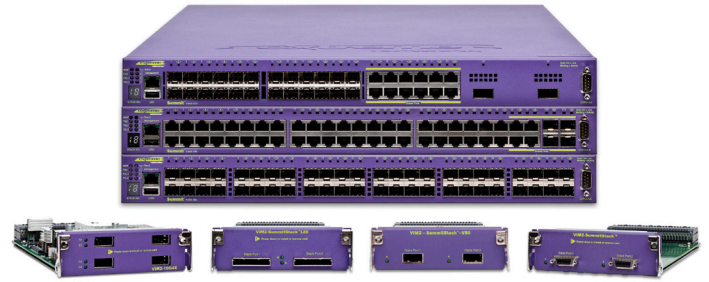

Summit® X480 Series—the scalable and versatile gigabit and 10 Gigabit Ethernet switch.

High-Performance Switching and Routing

- 48-port Gigabit Ethernet or 24-port gigabit and 2-port 10 Gigabit Ethernet connectivity in a 1RU form factor
- Optional 4-port 10 Gigabit Ethernet (GbE) to provide 40 Gbps uplinks
- Optional 40 Gbps stacking for up to eight switches in a stack to provide up to 384 Gigabit Ethernet connections in one logically integrated unit
- Optional 128 Gbps stacking for up to eight switches in a stack to provide high-speed stacking
- Optional stacking via 10 GbE ports (SummitStack-V), or optional SummitStack-V80 80 Gbps stacking
- Supports Layer 2 and Layer 3 switching, as well as MPLS/H-VPLS

High Scalability in a 1RU Compact Switch

- Up to 512K MAC address support for scalable Layer 2 networks
- Up to 512K IPv4 routes for scalable Layer 3 networks
- Up to 60K Access Control Lists (ACLs) for secure networks

High Availability

- ExtremeXOS® modular OS for highly available network operation
- Carrier-grade redundant networking protocol including Ethernet Automatic Protection Switching (EAPS)
- Internal redundant AC/DC power supply and field replaceable/hot swappable fan tray



Make Your Network Mobile

High-Performance and Highly Scalable Switching and Routing

Summit X480 offers core-class intelligent switching and routing with exceptional port density and high-performance stacking technology powered by the ExtremeXOS modular OS. With its high performance switching and routing, Summit X480 helps enhance the data center, Carrier Ethernet and enterprise aggregation network.

High-Performance Switching and Routing

Summit X480 is available in three different port configuration options: 24-port Gigabit Ethernet and 2-port 10 Gigabit Ethernet (Summit X480-24x), 48-port copper Gigabit Ethernet (Summit X480-48t), or 48-port fiber Gigabit Ethernet (Summit X480-48x). All front panel ports run at non-blocking, wire-speed performance and can carry wire-rate traffic towards the Versatile Interface Module-2 (VIM2) slot. Summit X480 offers flexible configuration by using optional VIM2 modules which are: 4-port 10 Gigabit Ethernet Module (VIM2-10G4X), 2-port SummitStack Module (VIM2-SummitStack), 2-port SummitStack128 Module (VIM2-SummitStack128) or 2-port SummitStack-V80 Module (VIM2-SummitStack-V80) (see Figure 1: Port configuration options for Summit X480 switches).

Flexible Port Configuration

Summit X480 offers flexible port configurations from standard configuration to optional VIM2 modules. For Summit X480-24x, half of the Gigabit Ethernet ports can handle dual personality—select from either 10/100/1000BASE-T copper Gigabit Ethernet or 100/1000BASE-X fiber Gigabit Ethernet connectivity. In the case of Summit X480-48t, the last four Gigabit Ethernet ports are configured as dual personality ports to provide flexibility between copper and fiber Gigabit Ethernet.

Through the VIM2 slot, Summit X480 can add an additional four 10 Gigabit Ethernet or SummitStack stacking ports. For stacking, depending upon the needs for bandwidth across the units in a stack, Summit X480 supports 40 Gbps SummitStack, 80 Gbps SummitStack-V80 or 128Gbps SummitStack128 through VIM2 option modules (See Figure 2: Summit X480-24x flexible port configuration). A third option, SummitStack-V, utilizes 10 GbE ports as stacking ports.

Summit X480 supports flexible 10 gigabit optical transceivers such as 10GBASE-SR, LR, ER and ZR as well as tunable DWDM. Tunable DWDM (Dense Wavelength Division Multiplexing) support allows service providers and others to tune XFP 10 Gigabit Ethernet optics to a specific frequency, reducing the need for additional fiber runs and XFP sparing. Digital Diagnostics Monitoring Interface support allows service providers to monitor and diagnose pluggable optics in real-time.

SummitStack – High-Performance Stacking

Summit X480 supports SummitStack, which provides 40 Gbps (VIM2-SummitStack), 80 Gbps (VIM2-SummitStack-V80) or 128 Gbps (VIM2-SummitStack128) of stacking bandwidth. High-speed 128 Gbps stacking is ideal for demanding applications where a high volume of traffic traverses through the stacking links, yet bandwidth is not compromised through stacking. High-speed stacking is very useful in applications such as top of rack when stacked with Summit X480 and Summit X650 (requires optional conversion cable) and gigabit aggregation in large enterprise or data center networks. With the longer stacking cables such as 5-meters, stacking can be configured through different racks horizontally in a row (see Figure 3) as opposed to typical stacking system installed vertically in a rack.

SummitStack-V – Flexible Stacking Over 10 Gigabit Ethernet

SummitStack-V capability utilizes 10 GbE ports as stacking ports, enabling the use of standard cabling and optics technologies used for 10 GbE such as XFP, SFP+, 10GBASE-T and XENPAK. SummitStack-V provides long-distance stacking connectivity of up to 40 km while reducing the cable complexity of implementing a stacking solution. SummitStack-V enabled 10 GbE ports must be physically direct-connected. SummitStack-V is compatible with Summit X450e, X450a, X460, X480, X650, X670 and X670V switches running the same version of ExtremeXOS.



High-Performance and Highly Scalable Switching and Routing

VIM Options	None (default option)	VIM2-10G4X	VIM2-SummitStack	VIM2-SummitStack-V80	VIM2-SummitStack128
Summit X480-24x	<ul style="list-style-type: none"> 24 x 100/1000BASE-X (SFP) 12 x 10/100/1000BASE-T (shared with the last 12 SFP ports) 2 x 10GBASE-X (XFP) 	<ul style="list-style-type: none"> 24 x 100/1000BASE-X (SFP) 12 x 10/100/1000BASE-T (shared with the last 12 SFP ports) 6 x 10GBASE-X (XFP) 	<ul style="list-style-type: none"> 24 x 100/1000BASE-X (SFP) 12 x 10/100/1000BASE-T (shared with the last 12 SFP ports) 2 x 10GBASE-X (XFP) 2 x SummitStack 	<ul style="list-style-type: none"> 24 x 100/1000BASE-X (SFP) 12 x 10/100/1000BASE-T (shared with the last 12 SFP ports) 2 x 10GBASE-X (XFP) 2 x SummitStack-V80 	<ul style="list-style-type: none"> 24 x 100/1000BASE-X (SFP) 12 x 10/100/1000BASE-T (shared with the last 12 SFP ports) 2 x 10GBASE-X (XFP) 2 x SummitStack128
Summit X480-48t	<ul style="list-style-type: none"> 48 x 10/100/1000BASE-T 4 x 100/1000BASE-X SFP (shared with the last 4 10/100/1000BASE-T ports) 	<ul style="list-style-type: none"> 48 x 10/100/1000BASE-T 4 x 100/1000BASE-X SFP (shared with the last 4 10/100/1000BASE-T ports) 4 x 10GBASE-X (XFP) 	<ul style="list-style-type: none"> 48 x 10/100/1000BASE-T 4 x 100/1000BASE-X SFP (shared with the last 4 10/100/1000BASE-T ports) 2 x SummitStack 	<ul style="list-style-type: none"> 48 x 10/100/1000BASE-T 4 x 100/1000BASE-X SFP (shared with the last 4 10/100/1000BASE-T ports) 2 x SummitStack-V80 	<ul style="list-style-type: none"> 48 x 10/100/1000BASE-T 4 x 100/1000BASE-X SFP (shared with the last 4 10/100/1000BASE-T ports) 2 x SummitStack128
Summit X480-48x	<ul style="list-style-type: none"> 48 x 100/1000BASE-X SFP 	<ul style="list-style-type: none"> 48 x 100/1000BASE-X SFP 4 x 10GBASE-X (XFP) 	<ul style="list-style-type: none"> 48 x 100/1000BASE-X SFP 2 x SummitStack 	<ul style="list-style-type: none"> 48 x 100/1000BASE-X SFP 2 x SummitStack-V80 	<ul style="list-style-type: none"> 48 x 100/1000BASE-X SFP 2 x SummitStack128

Figure 1: Port Configuration Options for Summit X480 Switches

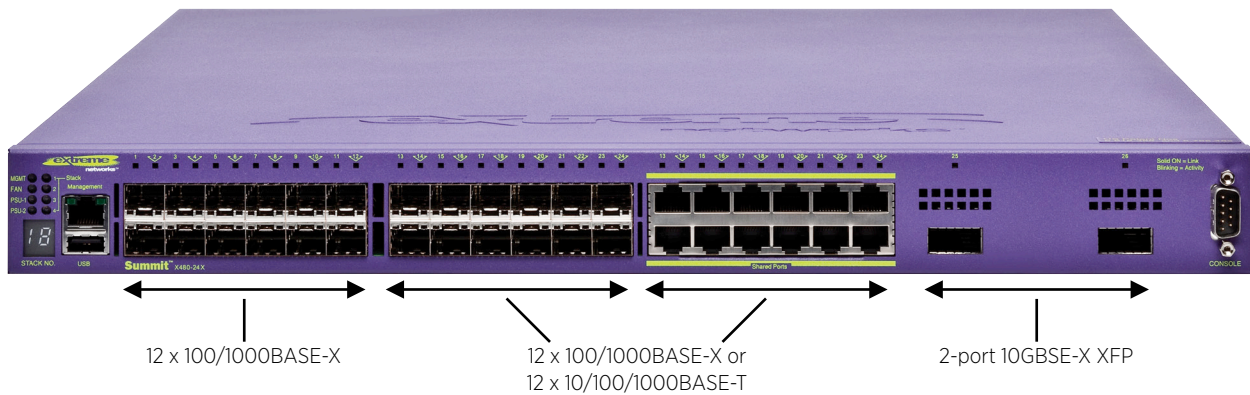

Figure 2: Summit X480-24x Flexible Port Configuration

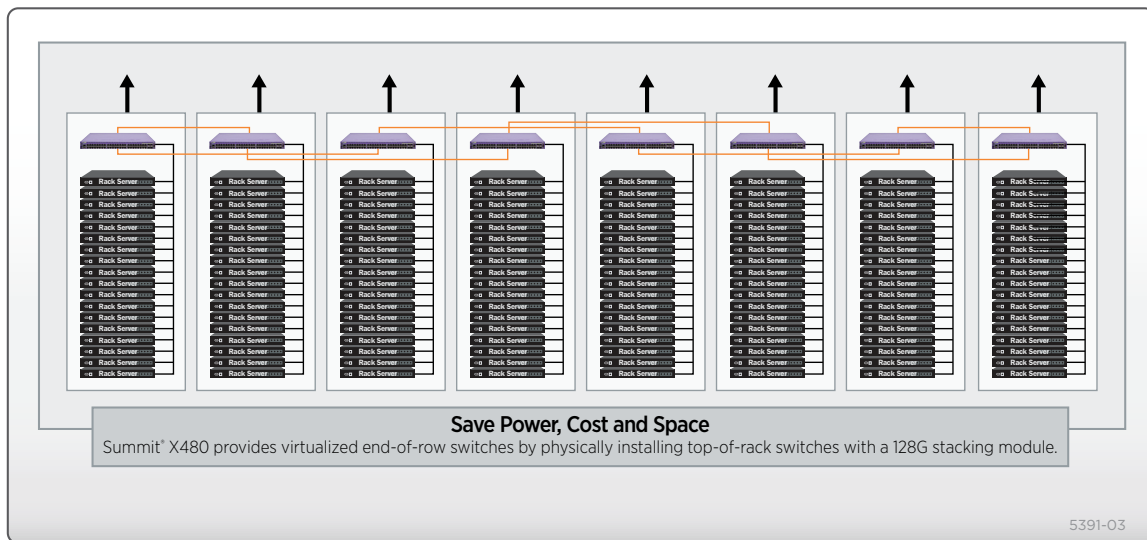

Figure 3: SummitStack Across Racks in a Row



High-Performance and Highly Scalable Switching and Routing

High Scalability in 1RU Compact Switch

Summit X480 supports highly scalable Layer 2 or Layer 3 networks, as well as highly secure networks. Summit X480 has expansion memory called TCAM built inside which can be partitioned by application types or by deployment scenarios. For larger Layer 2 network deployments, Summit X480 can

support up to 512K MAC addresses. Similarly for larger Layer 3 routing environments, Summit X480 can support core routing class scalability for up to 512K IPv4 routing LPM entries in hardware (See Figure 4: Summit X480 scalability).

Type	L2 MAC	L3 Host (IPv4/v6)	L3 LPM Route (IPv4/v6)	ACL (Ingress/Egress)
Lower Power Mode	32K	16K/8K	16K/8K	8K/1K
Default (Layer 2+Layer 3)	256K	16K/8K	256K/8K	8K/1K
Large Layer 2 Network Configuration	512K	16K/8K	16K/8K	8K/1K
Large Layer 3 Network Configuration	32K	16K/8K	512K/8K	8K/1K
Security Configuration	32K	16K/8K	16K/8K	60K/1K

Figure 4: Summit X480 Scalability

Supports Virtualized Data Centers

Summit X480 switches also support Direct Attach™, which eliminates the virtual switch layer, simplifying the network and improving performance. Direct Attach enables data center simplification by reducing network tiers from 4 or 5 tiers to just 3 or 2 tiers, depending on the size of the data center. To further enhance data center operations, Summit X480 switches

support XNV™ (ExtremeXOS Network Virtualization), a set of software modules for the ExtremeXOS based switching product portfolio, and available via the Data Center Feature Pack for Extreme Networks Ridgeline™, a network and service management application. XNV brings insight, control and automation for highly virtualized data centers to the network.



High-Performance and Highly Scalable Switching and Routing

Intelligent Switching and MPLS/H-VPLS Support

Summit X480 supports sophisticated and intelligent Layer 2 switching, as well as Layer 3 IPv4/IPv6 routing including policy-based switching/routing, Provider Bridges, bidirectional ingress and egress Access Control Lists, and bandwidth control by 8 Kbps granularity both for ingress and egress. To provide scalable network architectures used mainly for Carrier Ethernet network deployment, through a feature pack Summit X480

supports MPLS LSP based Layer 3 forwarding and Hierarchical VPLS (H-VPLS) for transparent LAN services. With H-VPLS, transparent Layer 3 networks can be extended throughout the Layer 3 network cloud by using a VPLS tunnel between the regional transparent LAN services typically built by Provider Bridges (IEEE 802.1ad) technology (see Figure 5: Summit X480 in a Carrier Ethernet application).

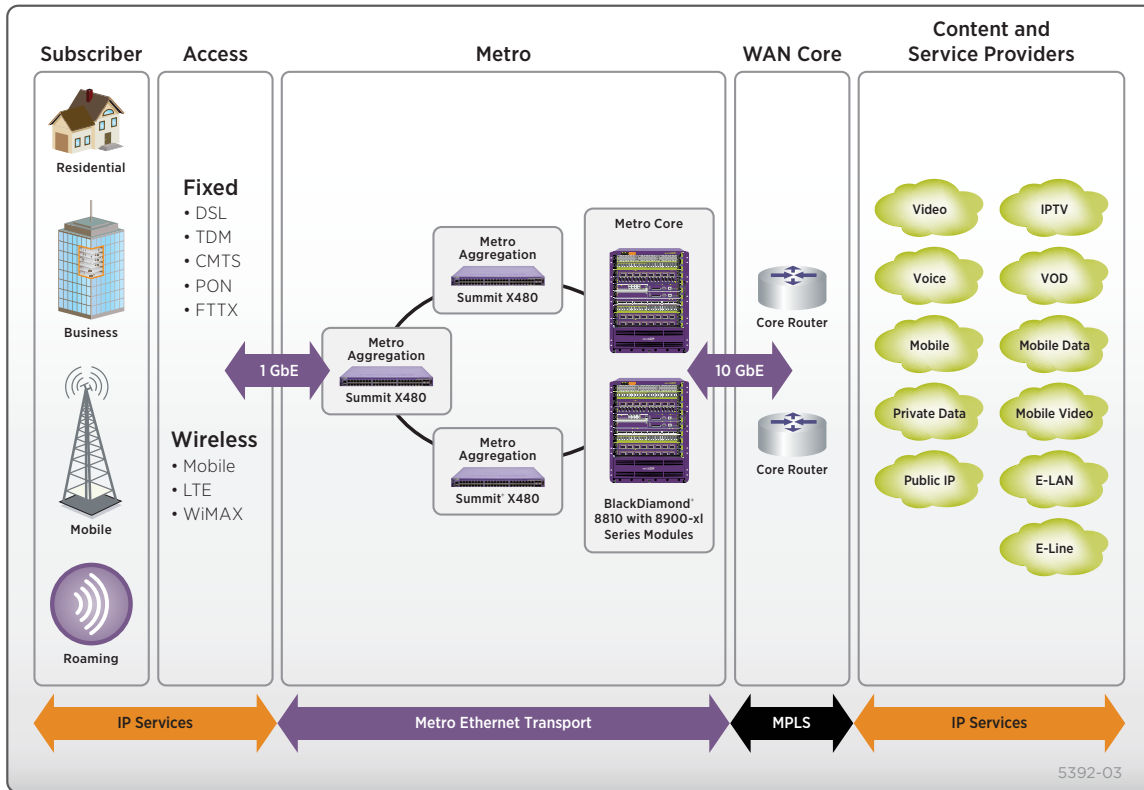

Figure 5: Summit X480 in a Carrier Ethernet Application



High Availability

Powered by the ExtremeXOS OS, Summit X480 supports process recovery and application upgrades without the need for a system reboot. Summit X480 provides the high network availability required for mission-critical servers and applications through its advanced modular OS, highly available hardware architecture and carrier-grade network redundancy protocols.

Modular Operating System for Continuous Operation

Preemptive Multitasking and Protected Memory

Summit X480 series switches allow each of many applications—such as Open Shortest Path First (OSPF) and Spanning Tree Protocol (STP)—to run as separate OS processes that are protected from each other. This drives increased system integrity and inherently protects against DoS attacks.

Process Monitoring and Restart

ExtremeXOS increases network availability using process monitoring and restart. Each independent OS process is monitored in real time. If a process becomes unresponsive or stops running, it can be automatically restarted.

Loadable Software Modules

The modular design of ExtremeXOS OS allows the upgrading of individual software modules, should this be necessary, leading to higher availability in the network (See Figure 7: ExtremeXOS modular design).

High Availability Network Protocols

Ethernet Automatic Protection Switching (EAPS)

EAPS allows the IP network to provide the level of resiliency and uptime that users expect from their traditional voice network. EAPS is more adaptable than Spanning Tree or Rapid Spanning Tree Protocols and offers sub-second (less than 50 milliseconds) recovery that delivers consistent failover regardless of the number of VLANs, network nodes or network topology. Since EAPS allows the network to recover almost transparently, Voice-over-IP (VoIP) calls will not drop and digital video feeds will not freeze or pixelize in most situations.

Spanning Tree/Rapid Spanning Tree Protocols

Summit X480 supports Spanning Tree (802.1D), Per VLAN Spanning Tree (PVST+), Rapid Spanning Tree (802.1w) and Multiple Instances of Spanning Tree (802.1s) protocols for Layer 2 resiliency.

Software-Enhanced Availability

Software-enhanced availability allows users to remain connected to the network even if part of the network infrastructure is down. Summit X480 continuously checks for problems in the uplink connections using advanced Layer 3 protocols such as OSPF, VRRP and Extreme Standby Router Protocol™ (ESRP, supported in Layer 2 or Layer 3), and dynamically routes traffic around the problem.

Equal Cost Multipath

Equal Cost Multipath (ECMP) routing allows uplinks to be load balanced for performance and cost savings while also supporting redundant failover. If an uplink fails, traffic is automatically routed to the remaining uplinks and connectivity is maintained.

Link Aggregation (802.3ad)

Link aggregation (LAG) allows trunking of up to eight links on a single logical connection. A maximum of 128 link aggregation groups can be created.

Multi-Switch LAG (M-LAG)

M-LAG can address bandwidth limitations and improve network resiliency, in part by routing network traffic around bottlenecks, reducing the risks of a single point of failure, and allowing load balancing across multiple switches.

Voice-Grade Stacking with SummitStack

All SummitStack stacking architecture is designed to support mission-critical applications by its highly available, rapid failover capability with n-1 master redundancy, distributed Layer 2 and Layer 3 switching, link aggregation across the stack, and distributed uplinks. SummitStack supports up to eight units in a stack, including any mix of Summit X650, X480, X460, X450a, X450e and X250e running the same version of ExtremeXOS and provides 50 milliseconds failover for path failure and hitless master/backup failover along with hitless protocol support such as OSPF graceful restart and Network Login user authentication.



High Availability

Alternatively, you may choose high-speed 80 Gbps stacking, which is ideal for demanding applications where a high volume of traffic traverses through the stacking links, yet bandwidth is not compromised through stacking. SummitStack-V80 also breaks the distance limitation for stacking technology by using QSFP+ technology. SummitStack-V80 can support passive copper cable (up to 5m), active multi-mode fiber cable (up to 100m), and QSFP+ optical transceivers which will be the standard technology for 40 GbE. With SummitStack-V80, the Summit X460 provides a flexible stacking solution inside the data center or central office to create a virtualized switching infrastructure across rows of racks. SummitStack-V80 is compatible with Summit X460, X480 and X670V switches running the same version of ExtremeXOS.

Summit X480 provides chassis-like management and availability with its SummitStack stacking technology (See Figure 8: SummitStack stacking architecture).

Hardware Redundancy

Summit X480 supports a dual redundant AC/DC power supply to provide high availability. The power supply can be hot-swapped and replaced should it fail. Summit X480 supports a hot-swappable, field replaceable fan.

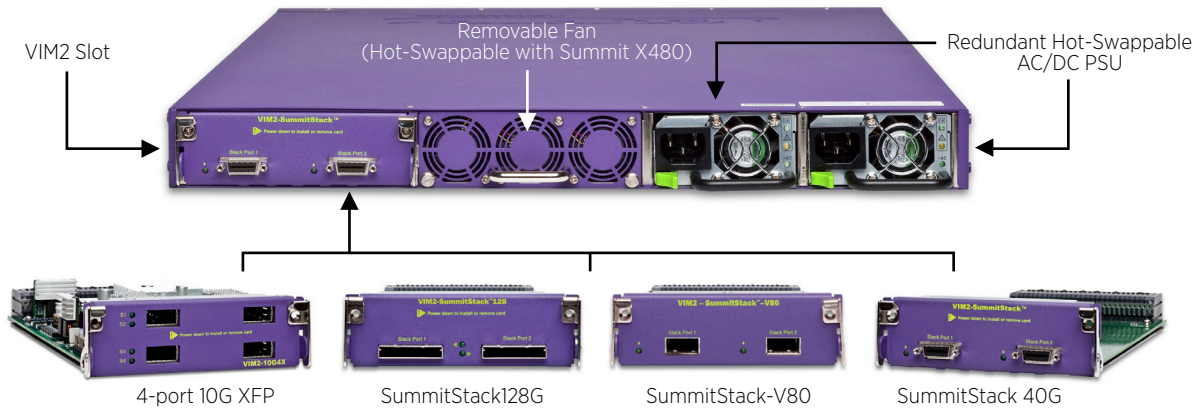

Figure 6: Summit X480 High Availability Design

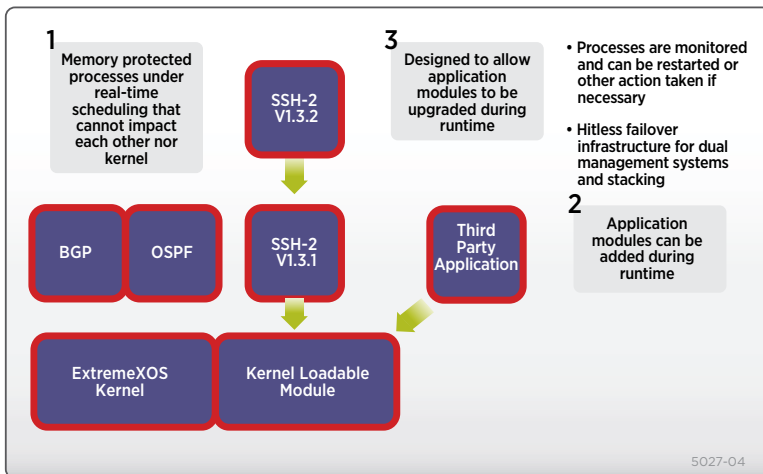

Figure 7: ExtremeXOS Modular Design

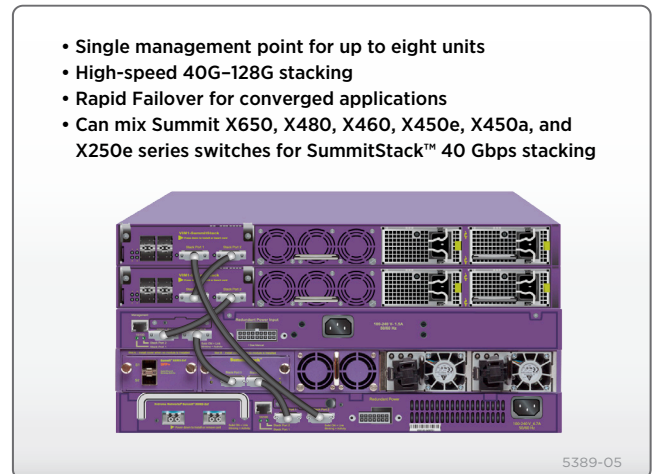

Figure 8: SummitStack Stacking Architecture



Comprehensive Security Management

Implementing a secure network means providing protection at the network perimeter as well as the core. Summit X480 uses advanced security functions in protecting your network from known or potential threats.

Robust IP and MAC Security Framework

NetLogin

Network Login provides three types of authentication—Web-based, MAC-based, and 802.1x—to properly authenticate network users against RADIUS servers. When combined with Extreme Networks Universal Port Manager (UPM), IT administrators can dynamically provision policies to associated network users based on roles or UPM profiles.

Media Access Control (MAC) Security

MAC security allows the lockdown of a port to a given MAC address and limiting the number of MAC addresses on a port. This can be used to dedicate ports to specific hosts or devices and avoid abuse of the port. In addition, an aging timer can be configured for the MAC lockdown, protecting the network from the effects of attacks using (often rapidly) changing MAC addresses.

IP Security

ExtremeXOS IP security framework protects the network infrastructure, network services and host computers from rogue access, spoofing and man-in-the-middle attacks. It also protects the network from statically configured and/or spoofed IP addresses and builds an external trusted database of MAC/IP/port bindings providing the traffic's source from a specific address for immediate defense.

Identity Manager

Identity Manager allows network managers to track users who access their network. User identity is captured based on NetLogin authentication, LLDP discovery and Kerberos snooping. ExtremeXOS uses the information to then report on the MAC, VLAN, computer hostname, and port location of the user. Further, Identity Manager can create both roles and policies, and then bind them together to create role-based profiles based on organizational structure or other logical groupings, and apply them across multiple users to allow appropriate access to network resources.

Private VLANs

Private VLANs provide port-to-port security to prevent unauthorized communication of users within the same VLAN. Unlike normal VLANs, ports enabled for Private VLANs cannot

communicate with other ports in the same VLAN over Layer 2 or Layer 3. Private VLAN ports can only communicate with a designated “uplink” port. In addition, a Private VLAN provides separation of broadcast domains within the same VLAN.

Threat Detection and Response

CLEAR-Flow Security Rules Engine

CLEAR-Flow provides first order threat detection and mitigation, and mirrors traffic to appliances for further analysis of suspicious traffic in the network.

Protocol Anomaly Detection

The Extreme Networks chipsets contain built-in hardware protocol checkers that support port security features for security applications, such as stateless DoS protection. The protocol checkers allow users to drop the packets based on conditions, which are checked for ingress packets prior to the Layer 2/Layer 3 entry table.

sFlow

sFlow® is a sampling technology that provides the ability to sample application-level traffic flows on all interfaces simultaneously.

IPFIX

IPFIX (Internet Protocol Flow Information eXport) defines an Internet standards-track protocol for a follow-on protocol to the proprietary Netflow. The technology is a complementary protocol to sFlow. IPFIX gathers information about network flows through the switch and sends the information to an external collector. Summit X480 includes hardware support to keep track of the flow records.

Port Mirroring

Summit X480 supports many-to-one and one-to-many port mirroring. This allows the mirroring of traffic to an external network appliance such as an intrusion detection device for trend analysis or for utilization by a network administrator for diagnostic purposes. Port mirroring can also be enabled across switches in a stack.



Comprehensive Security Management

Line-Rate ACLs

ACLs are one of the most powerful components used in controlling network resource utilization as well as protecting the network. ACLs are used for filtering the traffic, as well as classifying the traffic flow to control bandwidth, priority, mirroring, and policy-based routing/switching.

Denial of Service Protection

Summit X480 effectively handles Denial of Service (DoS) attacks. If the switch detects an unusually large number of packets in the CPU input queue, it assembles ACLs that automatically stop these packets from reaching the CPU. After a period of time, these ACLs are removed, and reinstalled if the attack continues.

Secure and Comprehensive Network Management

Summit X480 supports comprehensive network management through Command Line Interface (CLI), SNMP v1, v2c, v3, and ExtremeXOS ScreenPlay™ embedded XML-based Web user interface. With a variety of management options and consistency across other Extreme Networks modular and stackable switches, Summit X480 series switches provide ease of management for demanding converged applications.

Extreme Networks has developed tools that simplify and help in efficiently managing your network. Ridgeline network and service management provides fault, configuration, accounting, performance and security functions, allowing more effective management of Extreme Networks products, solutions and third-party devices, in a converged network.

For carrier networks, Ridgeline enables the shift from reactive circuit monitoring to proactive service management. The key features integrated into the Service Advisor Feature Pack unify service fulfillment, service assurance and service engineering to enable carriers to more effectively manage next-generation residential triple play, business Ethernet and Ethernet mobile backhaul services.



Target Applications

Top-of-Rack Switch for Servers in the Enterprise Data Centers

In the enterprise data center, many servers and storage systems are packed in racks, with all systems needing high-speed connectivity. A top-of-rack architecture is one way to simplify the cabling infrastructure and minimize the space requirements in the enterprise data center. Summit X480 is optimized to support high-density Gigabit Ethernet connectivity for servers and other network-attached devices and provides high-speed 80 Gbps or 128 Gbps stacking connectivity with the Summit X650 10 Gigabit Ethernet switch to provide the hybrid deployment for both gigabit and 10 gigabit enabled servers in the data centers.

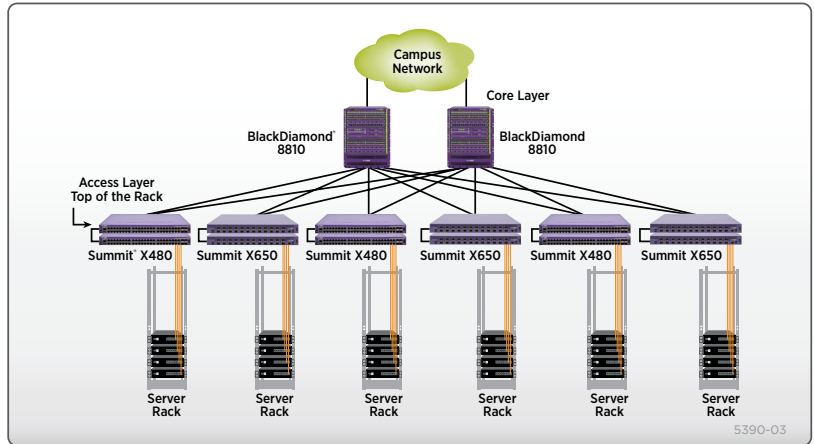

Figure 9: Top-of-Rack Architecture with Hybrid Deployment

High-Performance 10 Gigabit Core Switch for a Small Network and Aggregation Switch in a Traditional Three-Tiered Network

Summit X480 offers enterprise core-class scalability for both Layer 2 and Layer 3 switching. Summit X480 can support up to 512,000 Layer 2 MAC addresses or 512,000 IPv4 longest prefix matching routes. The Summit X480 switch can also be used in the network aggregation layer in an enterprise network. With its versatile design, Summit X480 can help simplify enterprise network deployment.

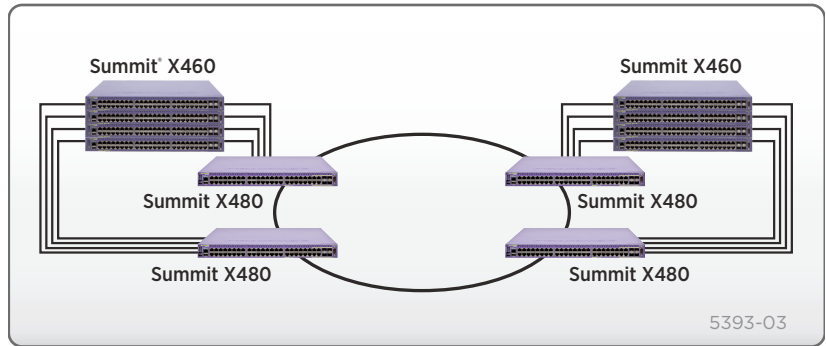

Figure 10: High-Performance 10G Core Switch

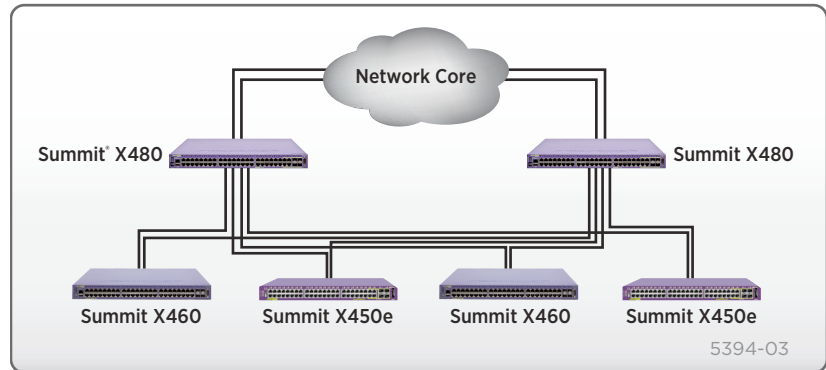

Figure 11: Summit X480 as an Aggregation Switch in a Three-Tier Network



Target Applications

Carrier Ethernet Network Switch that can Aggregate Connectivity for First Mile Access Concentrators

Summit X480 is an ideal service delivery platform for Carrier Ethernet networks. The advanced traffic management, resiliency and scalability features give it the flexibility to be deployed at the Provider Edge or as an aggregation switch. By supporting highly scalable Layer 2 and Layer 3 features along with MPLS/H-VPLS in hardware, Summit X480 can help simplify the network deployment.

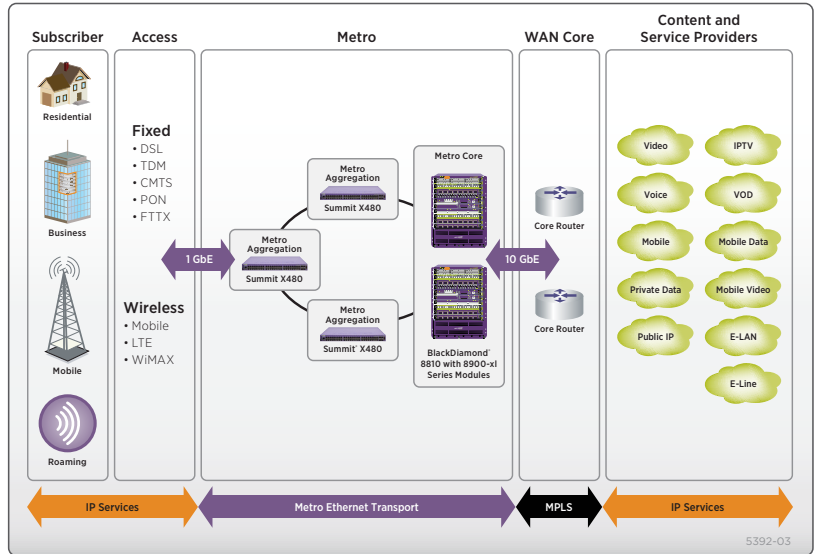

Figure 12: Summit X480 in a Carrier Ethernet Application



Technical Specifications

ExtremeXOS 12.5 Supported Protocols

Switching

- Switching (EAPS) and EAPsv2
- IEEE 802.1D – 1998 Spanning Tree Protocol (STP)
- IEEE 802.1D – 2004 Spanning Tree Protocol (STP and RSTP)
- IEEE 802.1w – 2001 Rapid Reconfiguration for STP, RSTP
- IEEE 802.1Q – 2003 (formerly IEEE 802.1s) Multiple Instances of STP, MSTP
- EMISTP, Extreme Multiple Instances of Spanning Tree Protocol
- PVST+, Per VLAN STP (802.1Q interoperable)
- Draft-ietf-bridge-rstpmib-03.txt – Definitions of Managed Objects for Bridges with Rapid Spanning Tree Protocol
- Extreme Standby Router Protocol (ESRP)
- IEEE 802.1Q – 1998 Virtual Bridged Local Area Networks
- IEEE 802.3ad Static load sharing configuration and LACP based dynamic configuration
- Software Redundant Ports
- Multi-switch Link Aggregation Groups (M-LAG)
- IEEE 802.1AB – LLDP Link Layer Discovery Protocol
- LLDP Media Endpoint Discovery (LLDP-MED), ANSI/TIA-1057, draft 08
- Extreme Discovery Protocol (EDP)
- Extreme Loop Recovery Protocol (ELRP)
- Extreme Link State Monitoring (ELSM)
- IEEE 802.1ag L2 Ping and traceroute, Connectivity Fault Management
- ITU-T Y.1731 Frame delay measurements

Management and Traffic Analysis

- RFC 2030 SNTP, Simple Network Time Protocol v4
- RFC 854 Telnet client and server
- RFC 783 TFTP Protocol (revision 2)
- RFC 951, 1542 BootP
- RFC 2131 BOOTP/DHCP relay agent and DHCP server
- RFC 1591 DNS (client operation)
- RFC 1155 Structure of Management Information (SMIv1)
- RFC 1157 SNMPv1
- RFC 1212, RFC 1213, RFC 1215 MIB-II, Ethernet-Like MIB & TRAPs
- RFC 1573 Evolution of Interface
- RFC 1650 Ethernet-Like MIB (update of RFC 1213 for SNMPv2)
- RFC 1901, 1905 – 1908 SNMPv2c, SMIv2 and Revised MIB-II
- RFC 2576 Coexistence between SNMP Version 1, Version 2 and Version 3
- RFC 2578 – 2580 SMIv2 (update to RFC 1902 – 1903)
- RFC 3410 – 3415 SNMPv3, user based security, encryption and authentication
- RFC 3826 – The Advanced Encryption Standard (AES) Cipher Algorithm in the SNMP User-based Security Model
- RFC 1757 RMON 4 groups: Stats, History, Alarms and Events

- RFC 2021 RMON2 (probe configuration)
- RFC 2613 SMON MIB
- RFC 2925 Ping/Traceroute MIB
- RFC 2668 802.3 MAU MIB
- draft-ietf-hubmib-mau-mib-v3-02.txt
- RFC 1643 Ethernet MIB
- RFC 1493 Bridge MIB
- RFC 2096 IPv4 Forwarding Table MIB
- RFC 2737 Entity MIB v2
- RFC 2233 Interface MIB
- RFC 3621 PoE-MIB (PoE switches only)
- IEEE 802.1ag MIB
- Secure Shell (SSH-2) client and server
- Secure Copy (SCP-2) client and server
- Secure FTP (SFTP) server
- sFlow version 5
- RFC 3917 IPFIX
- Configuration logging
- Multiple Images, Multiple Configs
- RFC 3164 BSD Syslog Protocol with Multiple Syslog Servers
 - 999 Local Messages (criticals stored across reboots)
- Extreme Networks vendor MIBs (includes FDB, PoE, CPU, Memory MIBs)
- XML APIs over Telnet/SSH and HTTP/HTTPS
- Web-based device management interface – ExtremeXOS ScreenPlay™
- IP Route Compression
- SFF-8472 DDMI (Digital Diagnostics Monitoring Interface)
- Stacking – SummitStack, SummitStack-V and SummitStack128

Security, Switch and Network Protection

- Secure Shell (SSH-2), Secure Copy (SCP-2) and SFTP client/server with encryption/authentication (requires export controlled encryption module)
- SNMPv3 user based security, with encryption/authentication (see above)
- RFC 1492 TACACS+
- RFC 2138 RADIUS Authentication
- RFC 2139 RADIUS Accounting
- RFC 3579 RADIUS EAP support for 802.1x
- RADIUS Per-command Authentication
- Access Profiles on All Routing Protocols
- Access Policies for Telnet/SSH-2/SCP-2
- Network Login – 802.1x, Web and MAC-based mechanisms
- IEEE 802.1x – 2001 Port-Based Network Access Control for Network Login
- Multiple supplicants with multiple VLANs for Network Login (all modes)
- Fallback to local authentication database (MAC and Web-based methods)
- Guest VLAN for 802.1x
- RFC 1866 HTML – Used for Web-based Network Login and ExtremeXOS ScreenPlay
- SSL/TLS transport – used for Web-based Network Login and ExtremeXOS ScreenPlay (requires export controlled encryption module)
- MAC Security – Lockdown and Limit
- IP Security – RFC 3046 DHCP Option 82 with port and VLAN ID
- IP Security – Trusted DHCP Server
- Layer 2/3/4 Access Control Lists (ACLs)
- RFC 2267 Network Ingress Filtering

- RPF (Unicast Reverse Path Forwarding) Control via ACLs
- Wire-speed ACLs
- Rate Limiting/Shaping by ACLs
- IP Broadcast Forwarding Control
- ICMP and IP-Option Response Control
- SYN attack protection
- CPU DoS Protection with traffic rate-limiting to management CPU
- Robust against common network attacks:
 - CERT (<http://www.cert.org>)
 - CA-2003-04: “SQL Slammer”
 - CA-2002-36: “SSHredder”
 - CA-2002-03: SNMP vulnerabilities
 - CA-98-13: tcp-denial-of-service
 - CA-98-01: smurf
 - CA-97-28: Teardrop_Land -Teardrop and “LAND” attack
 - CA-96-26: ping
 - CA-96-21: tcp_syn_flooding
 - CA-96-01: UDP_service_denial
 - CA-95-01: IP_Spoofing_Attacks_and_Hijacked_Terminal_Connections
 - IP Options Attack
- Host Attack Protection
 - Teardrop, boink, opentear, jolt2, newtear, nestea, syndrop, smurf, fraggle, papasmurf, synk4, raped, winfreeze, ping -f, ping of death, pepsi5, Latierra, Winnuke, Simping, Sping, Ascend, Stream, Land, Octopus

Security, Router Protection

- IP Security – DHCP enforcement via Disable ARP Learning
- IP Security – Gratuitous ARP Protection
- IP Security – DHCP Secured ARP/ARP Validation
- Routing protocol MD5 authentication

Security Detection and Protection

- CLEAR-Flow, threshold-based alerts and actions (*in non-SummitStack configuration only*)
- Identity Manager

IPv4 Host Services

- RFC 1122 Host Requirements
- RFC 768 UDP
- RFC 791 IP
- RFC 792 ICMP
- RFC 793 TCP
- RFC 826 ARP
- RFC 894 IP over Ethernet
- RFC 1027 Proxy ARP
- RFC 2068 HTTP server
- IGMP v1/v2/v3 Snooping with Configurable Router Registration Forwarding
- IGMP Filters
- PIM Snooping
- Static IGMP Membership
- Multicast VLAN Registration (MVR)

IPv4 Router Services

- RFC 1812 Requirements for IP Version 4 Routers
- RFC 1519 CIDR
- RFC 1256 IPv4 ICMP Router Discovery (IRDP)
- Static Unicast Routes
- Static Multicast Routes

Technical Specifications

- RFC 1058 RIP v1
- RFC 2453 RIP v2
- Static ECMP
- RFC 1112 IGMP v1
- RFC 2236 IGMP v2
- RFC 3376 IGMP v3
- RFC 2933 IGMP MIB
- RFC 2096 IPv4 Forwarding Table MIB
- RFC 1724 RIPv2 MIB
- RFC 3768 VRRPv2
- RFC 2787 VRRP MIB
- RFC 2328 OSPF v2 (Edge-mode)
- OSPF ECMP
- OSPF MD5 Authentication
- RFC 1587 OSPF NSSA Option
- RFC 1765 OSPF Database Overflow
- RFC 2370 OSPF Opaque LSA Option
- RFC 3623 OSPF Graceful Restart
- RFC 1850 OSPFv2 MIB
- RFC 2362 PIM-SM (Edge-mode)
- RFC 2934 PIM MIB
- RFC 3569, draft-ietf-ssm-arch-06.txt PIM-SSM PIM Source Specific Multicast
- draft-ietf-pim-mib-v2-01.txt
- Mtrace, a “traceroute” facility for IP Multicast: draft-ietf-idmr-traceroute-ipm-07
- Mrinfo, the multicast router information tool based on Appendix-B of draft-ietf-idmr-dvmp-03-11

IPv6 Host Services

- RFC 3587, Global Unicast Address Format
- Ping over IPv6 transport
- Traceroute over IPv6 transport
- RFC 5095, Internet Protocol, Version 6 (IPv6) Specification
- RFC 4861, Neighbor Discovery for IP Version 6, (IPv6)
- RFC 2463, Internet Control Message Protocol (ICMPv6) for the IPv6 Specification
- RFC 2464, Transmission of IPv6 Packets over Ethernet Networks
- RFC 2465, IPv6 MIB, General Group and Textual Conventions
- RFC 2466, MIB for ICMPv6
- RFC 2462, IPv6 Stateless Address Auto Configuration – Host Requirements
- RFC 1981, Path MTU Discovery for IPv6, August 1996 – Host Requirements
- RFC 3513, Internet Protocol Version 6 (IPv6) Addressing Architecture
- Telnet server over IPv6 transport
- SSH-2 server over IPv6 transport

IPv6 Interworking and Migration

- RFC 2893, Configured Tunnels
- RFC 3056, 6to4

IPv6 Router Services

- RFC 2462, IPv6 Stateless Address Auto Configuration – Router Requirements
- RFC 1981, Path MTU Discovery for IPv6, August 1996 – Router Requirements
- RFC 2710, IPv6 Multicast Listener Discovery v1 (MLDv1) Protocol
- Static Unicast routes for IPv6
- RFC 2080, RIPng
- RFC 2740 OSPF v3 (edge mode)
- Static ECMP

Core Protocols for Layer 2, IPv4 and IPv6

Requires Core License

- EAPsv2 Shared Ports – multiple interconnections between rings
- PIM-DM Draft IETF PIM Dense Mode draft-ietf-idmr-pim-dm-05.txt, draft-ietf-pim-dm-new-v2-04.txt
- RFC 3618 Multicast Source Discovery Protocol (MSDP)
- RFC 3446 Anycast RP using PIM and MSDP
- RFC 2740 OSPFv3, OSPF for IPv6
- RFC 1771 Border Gateway Protocol 4
- RFC 1965 Autonomous System Confederations for BGP
- RFC 2796 BGP Route Reflection (supersedes RFC 1966)
- RFC 1997 BGP Communities Attribute
- RFC 1745 BGP4/IDRP for IP-OSPF Interaction
- RFC 2385 TCP MD5 Authentication for BGPv4
- RFC 2439 BGP Route Flap Damping
- RFC 2918 Route Refresh Capability for BGP-4
- RFC 3392 Capabilities Advertisement with BGP-4
- RFC 4360 BGP Extended Communities Attribute
- RFC 4486 Subcodes for BGP Cease Notification message
- draft-ietf-idr-restart-10.txt Graceful Restart Mechanism for BGP
- RFC 4760 Multiprotocol extensions for BGP-4
- RFC 1657 BGP-4 MIB
- RFC 4893 BGP Support for Four-Octet AS Number Space
- Draft-ietf-idr-bgp4-mibv2-02.txt – Enhanced BGP-4 MIB
- RFC 1195 Use of OSI IS-IS for Routing in TCP/IP and Dual Environments (TCP/IP transport only)
- RFC 2763 Dynamic Hostname Exchange Mechanism for IS-IS
- RFC 2966 Domain-wide Prefix Distribution with Two-Level IS-IS
- RFC 2973 IS-IS Mesh Groups
- RFC 3373 Three-way Handshake for IS-IS Point-to-Point Adjacencies
- Draft-ietf-isis-restart-02 Restart Signaling for IS-IS
- Draft-ietf-isis-ipv6-06 Routing IPv6 with IS-IS
- Draft-ietf-isis-wg-multi-topology-11 Multi Topology (MT) Routing in IS-IS

QoS and VLAN Services

Quality of Service and Policies

- IEEE 802.1D – 1998 (802.1p) Packet Priority
- RFC 2474 DiffServ Precedence, including 8 queues/port
- RFC 2598 DiffServ Expedited Forwarding (EF)
- RFC 2597 DiffServ Assured Forwarding (AF)
- RFC 2475 DiffServ Core and Edge Router Functions

Traffic Engineering

- RFC 3784 IS-IS Externs for Traffic Engineering (wide metrics only)

VLAN Services: VLANs, vMANs

- IEEE 802.1Q VLAN Tagging
- IEEE 802.1v: VLAN classification by Protocol and Port
- Port-based VLANs
- Protocol-based VLANs

- MAC-based VLANs
- Multiple STP domains per VLAN
- Upstream Forwarding Only/Disable Flooding
- RFC 5517 Private VLANs
- VLAN Translation
- IEEE 802.1ad Provider Bridge Network, virtual MANs (vMANs)
- vMAN Ethertype Translation/Secondary vMAN Ethertype
- Multicast Support for PVLAN
- Multicast Support for VLAN Aggregation
- VLAN Aggregation

MPLS and VPN Services

Multi-Protocol Label Switching (MPLS)

Requires MPLS Feature Pack License

- RFC 2961 RSVP Refresh Overhead Reduction Extensions
- RFC 3031 Multiprotocol Label Switching Architecture
- RFC 3032 MPLS Label Stack Encoding
- RFC 3036 Label Distribution Protocol (LDP)
- RFC 3209 RSVP-TE: Extensions to RSVP for LSP Tunnels
- RFC 3630 Traffic Engineering Extensions to OSPFv2
- RFC 3811 Definitions of Textual Conventions (TCs) for Multiprotocol Label Switching (MPLS) Management
- RFC 3812 Multiprotocol Label Switching (MPLS) Traffic Engineering (TE) Management Information Base (MIB)
- RFC 3813 Multiprotocol Label Switching (MPLS) Label Switching Router (LSR) Management Information Base (MIB)
- RFC 3815 Definitions of Managed Objects for the Multiprotocol Label Switching (MPLS), Label Distribution Protocol (LDP)
- RFC 4090 Fast Re-route Extensions to RSVP-TE for LSP (Detour Paths)
- RFC 4379 Detecting Multi-Protocol Label Switched (MPLS) Data Plane Failures (LSP Ping)
- draft-ietf-bfd-base-09.txt Bidirectional Forwarding Detection

Layer 2 VPNs

Requires MPLS Feature Pack License

- RFC 4447 Pseudowire Setup and Maintenance using the Label Distribution Protocol (LDP)
- RFC 4448 Encapsulation Methods for Transport of Ethernet over MPLS Networks
- RFC 4762 Virtual Private LAN Services (VPLS) using Label Distribution Protocol (LDP) Signaling
- RFC 5085 Pseudowire Virtual Circuit Connectivity Verification (VCCV)
- RFC 5542 Definitions of Textual Conventions for Pseudowire (PW) Management
- RFC 5601 Pseudowire (PW) Management Information Base (MIB)
- RFC 5602 Pseudowire (PW) over MPLS PSN MIB
- RFC 5603 Ethernet Pseudowire (PW) MIB
- draft-ietf-l2vpn-vpls-mib-02.txt Virtual Private LAN Services (VPLS) MIB

Data Center

- Direct Attach (IEEE 802 VEPA) (Supported in a feature pack)
- XNV (ExtremeXOS Network Virtualization)

Technical Specifications

Summit X480

General Specifications

Performance

- 176 Gbps switch fabric bandwidth
- 224 Gbps, 448 Gbps (with VIM2-10G4X) aggregated switch bandwidth
- 71.4 Mpps, 101.2 Mpps (with VIM2-Summit-Stack), 166.7 Mpps (with VIM2-Summit-Stack128), 130.9 Mpps (with VIM2-10G4X) frame forwarding rate
- Less than 4 microsecond latency (64-byte)
- 9216 Byte maximum packet size (Jumbo Frame)
- 128 load sharing trunks, up to 8 members per trunk
- 4,094 VLANs (Port, Protocol, IEEE 802.1Q)
- 8,192 ingress and 1,024 egress ACL rules/ Front panel ports and /VIM2-10G4X module

CPU, Memory

- 64bit MIPS Processor Dual Core, 1GHz clock
- 1GB ECC DRAM
- 256MB Compact Flash
- USB port for external USB flash

Forwarding Tables and ACLs

Summit X480 provides flexible configuration options for various deployments.

Type	L2 MAC	L3 Host (IPv4/v6)	L3 LPM Route (IPv4/v6)	ACL (Ingress/Egress)
Lower Power Mode	32K	16K/8K	16K/8K	8K/1K
Default (Layer 2+Layer 3)	256K	16K/8K	256K/8K	8K/1K
Large Layer 2 Network Configuration	512K	16K/8K	16K/8K	8K/1K
Large Layer 3 Network Configuration	32K	16K/8K	512K/8K	8K/1K
Security Configuration	32K	16K/8K	16K/8K	60K/1K

Physical Specifications

Dimensions

Physical Dimensions

- Summit X480-24x switch
- Summit X480-48x switch
- Summit X480-48t switch
Height: 1.73 inches (4.4 cm)
Width: 17.4 inches (44.1 cm)
Depth: 19.0 inches (48.3 cm)
- VIM2-SummitStack module
- VIM2-10G4X module
- VIM2-SummitStack128 module
Height: 1.7 inches (4.3 cm)
Width: 5.2 inches (13.2 cm)
Depth: 9.9 inches (25.2 cm)
- Summit X480 fan module
Height: 1.7 inches (4.3 cm)
Width: 5.2 inches (13.2 cm)
Depth: 9.9 inches (25.2 cm)

QoS, Rate Limiting

- 8,192 ingress bandwidth meters/Front panel ports and /VIM2-10G4X module
- Ingress and egress bandwidth policing/rate limiting per flow/ACL
- 8 QoS egress queues/port
- Egress bandwidth rate shaping per egress queue and per port
- Rate Limiting Granularity: 8 Kbps

LED Indicators

- Per port status LED including power status
- System Status LEDs: management, fan and power

External Ports

- 12-port 100/1000BASE-X SFP, 12-port 100/1000BASE-X SFP and 10/100/1000BASE-T Combo, 2-port 10GBASE-X XFP, 1 open slot for VIM2 modules (Summit X480-24x)
- 44-port 10/100/1000BASE-T, 4-port 100/1000BASE-X SFP and 10/100/1000BASE-T Combo, 1 open slot for VIM2 modules (Summit X480-48t)

- 48-port 100/1000BASE-X SFP, 1 open slot for VIM2 modules (Summit X480-48x)
- 1-port RS-232c Serial (control port)
- 1 10/100/1000BASE-T out-of-band management port

External Ports for VIM2 Modules

- 4-port 10GBASE-X XFP (VIM2-10G4X)
- 2-port 20G SummitStack (VIM2-Summit-Stack)
- 2-port 64G SummitStack (VIM2-SummitStack128)

Option Slot

- Slot for Versatile Interface Module 2 (VIM2) available for Summit X480-24x, Summit X480-48t and Summit X480-48x

Power Supply Support

- Summit X480 AC PSU and Summit X480 DC PSU

Weight

- Summit X480-24x switch 20.9 lb (9.5 kg)
- Summit X480-48x switch 22.7 lb (10.3 kg)
- Summit X480-48t switch 21.2 lb (9.6 kg)
NOTE: Switch weights include installed fan module. They do not include installed VIM2 modules or PSUs.
- VIM2-SummitStack module 2.03 lb (0.92 kg)
- VIM2-10G4X module 2.76 lb (1.25 kg)
- VIM2-SummitStack128 module 2.05 lb (0.93 kg)
- Summit X480 fan module 0.45 lb (0.99 kg)

Fan Speed

- Minimum speed 4500 RPM
- Maximum speed 18000 RPM

Operating Specifications

- Operating Temperature Range: 0° C to 45° C (32° F to 113° F)
- Operating Humidity: 10% to 93% relative humidity, non-condensing

- Operating Altitude: 0-3,000 meters (9,850 feet)
- Operational Shock (Half Sine): 30 m/s² (3 g), 11ms, 60 Shocks
- Operational Random Vibration: 3-500 MHz @ 1.5g rms

Storage & Transportation Conditions (Packaged)

- Transportation Temperature: -40° C to 70° C (-40° F to 158° F)
- Storage and Transportation Humidity: 10% to 95% RH, non-condensing
- Packaged Shock (Half Sine): 180 m/s² (18 g), 6ms, 600 shocks
- Packaged Sine Vibration: 5-62 Hz @ Velocity 5mm/s, 62-500 Hz @ 0.2G
- Packaged Random Vibration: 5-20 Hz @ 1.0 ASD w/-3dB/oct. from 20-200 Hz
- 14 drops min on sides & corners @ 42" (<15 kg box)

Technical Specifications

Power Specifications

Summit X480-24x

Summit X480-24x with No Installed VIM (AC Power Supply)

- Nominal input ratings 100 to 240 V, 50/60 Hz, 3.5 A
- Input current 2.0 A @ 100 V (low-line) 0.9 A @ 240 V (high-line)
- Heat dissipation, Watts, BTU 195 W, 663 BTU/hr
- Power consumption, Watts, BTU 195 W, 663 BTU/hr

Summit X480-24x with VIM2-SummitStack Module (AC Power Supply)

- Nominal input ratings 100 to 240 V, 50/60 Hz, 3.5 A
- Input current 2.01 A @ 100 V (low-line) 0.88 A @ 240 V (high-line)
- Heat dissipation, Watts, BTU 200 W, 680 BTU/hr
- Power consumption, Watts, BTU 200 W, 680 BTU/hr

Summit X480-24x with VIM2-10G4X Module (AC Power Supply)

- Nominal input ratings 100 to 240 V, 50/60 Hz, 3.5 A
- Input current 2.4 A @ 100 V (low-line) 1.1 A @ 240 V (high-line)
- Heat dissipation, Watts, BTU 241 W, 823 BTU/hr
- Power consumption, Watts, BTU 241 W, 823 BTU/hr

Summit X480-24x with VIM2-SummitStack128 Module (AC Power Supply)

- Nominal input ratings 100 to 240 V, 50/60 Hz, 3.5 A
- Input current 2.08 A @ 100 V (low-line) 0.91 A @ 240 V (high-line)
- Heat dissipation, Watts, BTU 206 W, 704 BTU/hr
- Power consumption, Watts, BTU 206 W, 704 BTU/hr

Summit X480-24x with No Installed VIM (DC Power Supply)

- Nominal input ratings 48 V, 7.5 A
- Input current 3.25 A @ 48 V (low-line) 2.6 A @ 60 V (high-line)
- Heat dissipation, Watts, BTU 156 W, 532 BTU/hr
- Power consumption, Watts, BTU 156 W, 532 BTU/hr

Summit X480-24x with VIM2-SummitStack Module (DC Power Supply)

- Nominal input ratings 48 V, 7.5 A
- Input current 3.4 A @ 48 V (low-line) 2.7 A @ 60 V (high-line)
- Heat dissipation, Watts, BTU 161 W, 550 BTU/hr
- Power consumption, Watts, BTU 161 W, 550 BTU/hr

Summit X480-24x with VIM2-10G4X Module (DC Power Supply)

- Nominal input ratings 48 V, 7.5 A
- Input current 5.7 A @ 48 V (low-line) 4.2 A @ 60 V (high-line)
- Heat dissipation, Watts, BTU 246 W, 839 BTU/hr
- Power consumption, Watts, BTU 246 W, 839 BTU/hr

Summit X480-24x with VIM2-SummitStack128 Module (DC Power Supply)

- Nominal input ratings 48 V, 7.5 A
- Input current 3.5 A @ 48 V (low-line) 2.8 A @ 60 V (high-line)
- Heat dissipation, Watts, BTU 167 W, 569 BTU/hr
- Power consumption, Watts, BTU 167 W, 569 BTU/hr

Summit X480-48x

Summit X480-48x with No Installed VIM (AC Power Supply)

- Nominal input ratings 100 to 240 V, 50/60 Hz, 4.0 A
- Input current 2.0 A @ 100 V (low-line) 0.9 A @ 240 V (high-line)
- Heat dissipation, Watts, BTU 200 W, 675 BTU/hr
- Power consumption, Watts, BTU 200 W, 675 BTU/hr

Summit X480-48x with VIM2-SummitStack Module (AC Power Supply)

- Nominal input ratings 100 to 240 V, 50/60 Hz, 4.0 A
- Input current 2.01 A @ 100 V (low-line) 0.89 A @ 240 V (high-line)
- Heat dissipation, Watts, BTU 203 W, 692 BTU/hr
- Power consumption, Watts, BTU 203 W, 692 BTU/hr

Summit X480-48x with VIM2-10G4X Module (AC Power Supply)

- Nominal input ratings 100 to 240 V, 50/60 Hz, 4.0 A
- Input current 2.3 A @ 100 V (low-line) 1.0 A @ 240 V (high-line)
- Heat dissipation, Watts, BTU 227 W, 774 BTU/hr
- Power consumption, Watts, BTU 227 W, 774 BTU/hr

Summit X480-48x with VIM2-SummitStack128 Module (AC Power Supply)

- Nominal input ratings 100 to 240 V, 50/60 Hz, 4.0 A
- Input current 2.04 A @ 100 V (low-line) 0.89 A @ 240 V (high-line)
- Heat dissipation, Watts, BTU 202 W, 688 BTU/hr
- Power consumption, Watts, BTU 202 W, 688 BTU/hr

Summit X480-48x with No Installed VIM (DC Power Supply)

- Nominal input ratings 48 V, 8.0 A
- Input current 3.3 A @ 48 V (low-line) 2.6 A @ 60 V (high-line)
- Heat dissipation, Watts, BTU 158 W, 540 BTU/hr
- Power consumption, Watts, BTU 158 W, 540 BTU/hr

Summit X480-48x with VIM2-SummitStack Module (DC Power Supply)

- Nominal input ratings 48 V, 8.0 A
- Input current 3.4 A @ 48 V (low-line) 2.7 A @ 60 V (high-line)
- Heat dissipation, Watts, BTU 163 W, 556 BTU/hr
- Power consumption, Watts, BTU 163 W, 556 BTU/hr

Summit X480-48x with VIM2-10G4X Module (DC Power Supply)

- Nominal input ratings 48 V, 8.0 A
- Input current 5.7 A @ 48 V (low-line) 4.4 A @ 60 V (high-line)
- Heat dissipation, Watts, BTU 246 W, 839 BTU/hr
- Power consumption, Watts, BTU 246 W, 839 BTU/hr

Summit X480-48x with VIM2-SummitStack128 Module (DC Power Supply)

- Nominal input ratings 48 V, 8.0 A
- Input current 3.4 A @ 48 V (low-line) 2.7 A @ 60 V (high-line)
- Heat dissipation, Watts, BTU 165 W, 562 BTU/hr
- Power consumption, Watts, BTU 165 W, 562 BTU/hr

Summit X480-48t

Summit X480-48t with No Installed VIM (AC Power Supply)

- Nominal input ratings 100 to 240 V, 50/60 Hz, 3.0 A
- Input current 1.9 A @ 100 V (low-line) 0.8 A @ 240 V (high-line)
- Heat dissipation, Watts, BTU 182 W, 622 BTU/hr
- Power consumption, Watts, BTU 182 W, 622 BTU/hr

Summit X480-48t with VIM2-SummitStack Module (AC Power Supply)

- Nominal input ratings 100 to 240 V, 50/60 Hz, 3.0 A
- Input current 1.89 A @ 100 V (low-line) 0.84 A @ 240 V (high-line)
- Heat dissipation, Watts, BTU 187 W, 639 BTU/hr
- Power consumption, Watts, BTU 187 W, 639 BTU/hr

Technical Specifications

Summit X480-48t with VIM2-10G4X Module (AC Power Supply)

- Nominal input ratings 100 to 240 V, 50/60 Hz, 3.0 A
- Input current 2.34 A @ 100 V (low-line) 1.0 A @ 240 V (high-line)
- Heat dissipation, Watts, BTU 232 W, 793 BTU/hr
- Power consumption, Watts, BTU 232 W, 793 BTU/hr

Summit X480-48t with VIM2-SummitStack128 Module (AC Power Supply)

- Nominal input ratings 100 to 240 V, 50/60 Hz, 3.0 A
- Input current 1.89 A @ 100 V (low-line) 0.84 A @ 240 V (high-line)
- Heat dissipation, Watts, BTU 256 W, 871 BTU/hr
- Power consumption, Watts, BTU 256 W, 871 BTU/hr

Summit X480-48t with No Installed VIM (DC Power Supply)

- Nominal input ratings 48 V, 7.0 A
- Input current 3.1 A @ 48 V (low-line) 2.4 A @ 60 V (high-line)
- Heat dissipation, Watts, BTU 148 W, 503 BTU/hr
- Power consumption, Watts, BTU 148 W, 503 BTU/hr

Summit X480-48t with VIM2-SummitStack Module (DC Power Supply)

- Nominal input ratings 48 V, 7.0 A
- Input current 3.24 A @ 48 V (low-line) 2.5 A @ 60 V (high-line)
- Heat dissipation, Watts, BTU 153 W, 520 BTU/hr
- Power consumption, Watts, BTU 153 W, 520 BTU/hr

Summit X480-48t with VIM2-10G4X Module (DC Power Supply)

- Nominal input ratings 48 V, 7.0 A
- Input current 3.1 A @ 48 V (low-line) 2.4 A @ 60 V (high-line)
- Heat dissipation, Watts, BTU 148 W, 503 BTU/hr
- Power consumption, Watts, BTU 148 W, 503 BTU/hr

Summit X480-48t with VIM2-SummitStack128 Module (DC Power Supply)

- Nominal input ratings 48 V, 7.0 A
- Input current 3.2 A @ 48 V (low-line) 2.5 A @ 60 V (high-line)
- Heat dissipation, Watts, BTU 153 W, 522 BTU/hr
- Power consumption, Watts, BTU 153 W, 522 BTU/hr

Power Supply Units

Summit X480 AC PSU

For use with the Summit X480-24x, Summit X480-48x, and Summit X480-48t switches

Physical Specifications

- Height: 1.57 inches (4.0 cm)
- Width: 4.8 inches (12.3 cm)
- Depth: 13.31 Inches (33.8 cm)
- Weight 3.64 lb (1.65 kg)

Power Specifications

- Voltage input range 90 to 264 V
- Nominal input ratings 100 to 240 V, 50 to 60 Hz, 8 A
- Nominal input current at full loads 12 A @ 90 V (low-line) 5 A @ 230 V (high-line)
- Line frequency range 47 to 63 Hz
- Maximum inrush current 15 A
- Output 12 V, 37 A max, 450 Watts 3.3 V, 3 A max, 9.9 Watts
- Maximum continuous DC output shall not exceed 450 Watts
- Power supply input socket IEC 320 C14
- Power cord input plug IEC 320 C13
- Power supply cord gauge 18 AWG (0.75 mm²) up to 6 feet or 2 meters or 16 AWG (1.0 mm²) over 6 feet
- Efficiency 84% typical at full load, high line

Summit X480 DC PSU

For use with the Summit X480-24x, X480-48x, and X480-48t switches

Physical Specifications

- Height: 1.57 inches (4.0 cm)
- Width: 4.8 inches (12.3 cm)
- Depth: 13.31 Inches (33.8 cm)
- Weight 2.58 lb (1.17 kg)

Power Specifications

- Nominal Input -48 to -60 VDC, 24 A
- DC Voltage Input Range -40 to -75 V
- Maximum Input Amperages 13.5 A @ 40 V 11.2 A @ 48 V 7.5 A @ 72 V
- Inrush Current 10 A peak
- Inrush Energy 1.5 A2S
- Minimum wire size 14 AWG (1.5 mm²) copper stranded
- DC Output 12 V , 36.7 A/3.3 V, 3.0 A
- DC Output Power (W) 450 W

All Summit X480 Series Switches

Regulatory/Safety

North American Safety of ITE

- UL 60950-1 1st Ed., Listed Device (U.S.)
- CSA 22.2#60950-1-03 1st Ed. (Canada)
- Complies with FCC 21CFR 1040.10 (U.S. Laser Safety)
- CDRH Letter of Approval (U.S. FDA Approval)

European Safety of ITE

- EN60950-1:2006
- EN 60825-1+A2:2001 (Lasers Safety)
- TUV-R GS Mark by German Notified Body
- 2006/95/EC Low Voltage Directive

International Safety of ITE

- CB Report & Certificate per IEC 60950-1:2006 + National Differences
- AS/NZS 60950-1 (Australia/New Zealand)

EMI/EMC Standards

North America EMC for ITE

- FCC CFR 47 part 15 Class A (U.S.)
- ICES-003 Class A (Canada)

European EMC Standards

- EN 55022:2006 Class A
- EN 55024:A2-2003 Class A includes IEC 61000-4-2, 3, 4, 5, 6, 11
- EN 61000-3-2,8-2006 (Harmonics)
- EN 61000-3-3 1995+A2:2005 (Flicker)
- ETSI EN 300 386 v1.3.3, 2005-04 (EMC Telecommunications)
- 2004/108/EC EMC Directive

International EMC Certifications

- CISPR 22: 2006 Ed 5.2, Class A (International Emissions)
- CISPR 24:A2:2002 Class A (International Immunity)
- EC/EN 61000-4-2:2008 Electrostatic Discharge, 8kV Contact, 15 kV Air, Criteria A
- EC/EN 61000-4-3:2008 Radiated Immunity 10V/m, Criteria A
- EC/EN 61000-4-4:2005 Transient Burst, 1 kV, Criteria A
- IEC/EN 61000-4-5:2005 Surge, 2 kV L-L, 2 kV L-G, Level 3, Criteria A
- IEC/EN 61000-4-6:2007 Conducted Immunity, 0.15-80 MHz, 10V/m unmod. RMS, Criteria A
- EC/EN 61000-4-11:2004 Power Dips & Interruptions, >30%, 25 periods, Criteria C

Country Specific

- VCCI Class A (Japan Emissions)
- ACMA (C-Tick) (Australia Emissions)
- CCC Mark
- KCC Mark EMC Approval (Korea)

Telecom Standards

- EN/ETSI 300 386:2005-04 (EMC Telecommunications)
- EN/ETSI 300 019 (Environmental for Telecommunications)
- NEBS Level 3 compliant to portions of GR-1089 Issue 4 & GR-63 Issue 3 as defined in SR3580 with exception to filter requirement
- MEF 9
- MEF 14

IEEE 802.3 Media Access Standards

- IEEE 802.3ab 1000BASE-T
- IEEE 802.3z 1000BASE-X
- IEEE 802.3ae 10GBASE-X

Technical Specifications

Environmental Standards

- EN/ETSI 300 019-2-1 v2.1.2 (2000-09) – Class 1.2 Storage
- EN/ETSI 300 019-2-2 v2.1.2 (1999-09) – Class 2.3 Transportation
- EN/ETSI 300 019-2-3 v2.1.2 (2003-04) – Class 3.1e Operational
- EN/ETSI 300 753 (1997-10) – Acoustic Noise
- ASTM D3580 Random Vibration Unpackaged 1.5G

Warranty

- Ltd. 1-year on Hardware
- 90-days on Software
- For warranty details, visit www.extremenetworks.com/go/warranty

Ordering Information

Part Number	Name	Description
16301	Summit X480-48t	48 10/100/1000BASE-T, 4 100/1000BASE-X unpopulated SFP (shared), No PSU with two unpopulated PSU slots, one VIM2 slot, ExtremeXOS Advanced Edge license
16303	Summit X480-24x	24 100/1000BASE-X unpopulated SFP, 12 10/100/1000BASE-T (shared), 2 unpopulated XFP ports, No PSU with two unpopulated PSU slots, one VIM2 slot, ExtremeXOS Advanced Edge license
16304	Summit X480-48x	48 100/1000BASE-X unpopulated SFP, No PSU with two unpopulated PSU slots, one VIM2 slot, ExtremeXOS Advanced Edge license
16311	VIM2-SummitStack	VIM2-SummitStack, 2 SummitStack stacking ports
16312	VIM2-10G4X	VIM2-10G4X, 4 10GBASE-X XFP ports
16313	VIM2-SummitStack128	VIM2-SummitStack128, 2 x 64G stacking ports
16315	VIM2-SummitStack-V80	VIM2-SummitStack-V80, 2 x 40G stacking ports
16321	Summit X480 Core License	ExtremeXOS Core License for Summit X480 series switches
16322	Summit X480 MPLS Feature Pack	ExtremeXOS MPLS Feature Pack for Summit X480 series switches
11011	Direct Attach Feature Pack	Direct Attach Feature Pack for Summit X450a/X460/X480, Summit X650 and BlackDiamond 8800 Series with ExtremeXOS 12.5.1 or Greater
10916	Summit X480/X650 FAN Module	FAN module for Summit X480 and Summit X650 series switches, spare
10917	Summit X480 AC PSU	AC Power Supply module for Summit X480 series switches
10918	Summit X480 DC PSU	DC Power Supply module for Summit X480 series switches
10121	10GBASE-SR XFP	10GBASE-SR XFP Transceiver, 850nm, up to 300m on Multimode Fiber, LC Connector
10122	10GBASE-LR XFP	10GBASE-LR XFP Transceiver, 1310nm, up to 10km on Single-mode Fiber, LC Connector
10124	10GBASE-ER XFP	10GBASE-ER XFP Transceiver, 1550nm up to 40km on Single-mode Fiber, LC Connector
10125	10GBASE-ZR XFP	10GBASE-ZR XFP Transceiver, 1550nm, up to 80km on Single-mode Fiber, LC Connector
10200	Tunable DWDM XFP	10 Gigabit Ethernet XFP Tunable DWDM module, C-band, SMF 80km, LC connector
10051	1000BASE-SX SFP	1000BASE-SX SFP, LC Connector
10052	1000BASE-LX SFP	1000BASE-LX SFP, LC Connector
10053	1000BASE-ZX SFP	1000BASE-ZX SFP, Extra Long Distance SMF 70 km/21 dB Budget, LC Connector
10056	1000BASE-BX-D SFP	1000BASE-BX-D SFP, SMF (1490nm TX/1310nm RX Wavelength)
10057	1000BASE-BX-U SFP	1000BASE-BX-U SFP, SMF (1310nm TX/1490nm RX Wavelength)
10060	100FX/1000LX SFP ¹	100FX/1000LX SFP, SMF, LC Connector (Requires MCP and 6dB Attenuator for 100FX-MMF Operation)
10063	100FX SFP ¹	100FX SFP, MMF, LC Connector
10064	1000BASE-LX100 SFP	1000BASE-LX100 SFP, Extra Long Distance SMF 100 km/30dB Budget, LC Connector
10065	10/100/1000BASE-T SFP ¹	10/100/1000BASE-T, SFP, CAT 5 cable 100m, RJ-45 Connector
10067	100BASE-FX SFP	100M SFP, 100FX MMF, (1310nm, 2km multimode transmission) LC connector
10066	100BASE-LX10 SFP	100M SFP, 100LX10 SMF, (1310nm 10km singlemode transmission) LC connector
10058	100BASE-BX-D SFP	100M SFP, 100BASE-BX-D, SMF (1550nm TX/1310nm RX wavelength), 100 Mbps bidirectional
10059	100BASE-BX-U SFP	100M SFP, 100BASE-BX-U, SMF (1310nm TX/1550nm RX wavelength), 100 Mbps bidirectional

¹ Not supported on Combo ports

Ordering Information

Part Number	Name	Description
10312	QSFP+ passive copper cable, 1.0M	QSFP+ passive copper cable, 1.0M
10315	QSFP+ active fiber cable, 10M	QSFP+ active fiber cable, 10M
10318	QSFP+ active fiber cable, 100M	QSFP+ active fiber cable, 100M
16106	Stacking Cable, 0.5M	SummitStack/UniStack™ Stacking Cable, 0.5M
16107	Stacking Cable, 1.5M	SummitStack/UniStack Stacking Cable, 1.5M
16108	Stacking Cable, 3.0M	SummitStack/UniStack Stacking Cable, 3.0M
16105	Stacking Cable, 5.0M ²	SummitStack Stacking Cable, 5.0M
17030	Stacking Cable 64G, 1.0M	SummitStack128 Stacking Cable, 1.0M
17026	Stacking Cable 128G to 64G, 1.0M	Conversion cable for SummitStack256 and SummitStack128, 1.0M
17034	Stacking Cable 128G to 20G, 1.0M	Conversion cable for SummitStack256 and SummitStack, 1.0M
17038	Stacking Cable 64G to 20G, 1.0M	Conversion cable for SummitStack128 and SummitStack, 1.0M

² Not supported when using with Summit X650 and UniStack



Make Your Network Mobile

Corporate and North America
 Extreme Networks, Inc.
 3585 Monroe Street
 Santa Clara, CA 95051 USA
 Phone +1 408 579 2800

Europe, Middle East, Africa and South America
 Phone +31 30 800 5100

Asia Pacific
 Phone +65 6836 5437

Japan
 Phone +81 3 5842 4011

extremenetworks.com