



Muffin AC - MU2B1 - 028027
 (Family) (Model) (Part Number)



Electrical Specifications

Rated Voltage:	115 VAC
AC Frequency:	60 Hz
Power Supply:	14.0 Watts
Line Current:	0.16 Amps
Locked Rotor Current	0.25 Amps
Nominal Speed:	3100 RPM

Mechanical Specifications

Dimensions:	4.72in x 1.50in
Weight	17.2 oz
Max Airflow @ 0 in H ₂ O	102.0 CFM
Max Pressure @ 0 CFM	0.296 in H ₂ O
Noise	45.1 dBA

Fan Performance

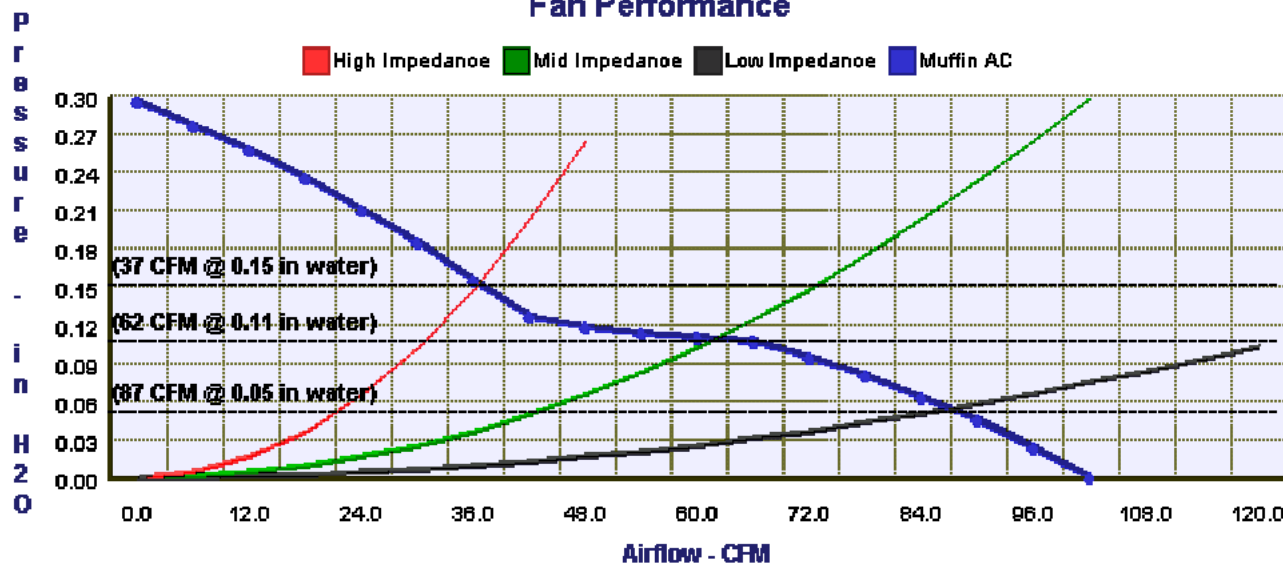



Mechanical Drawing

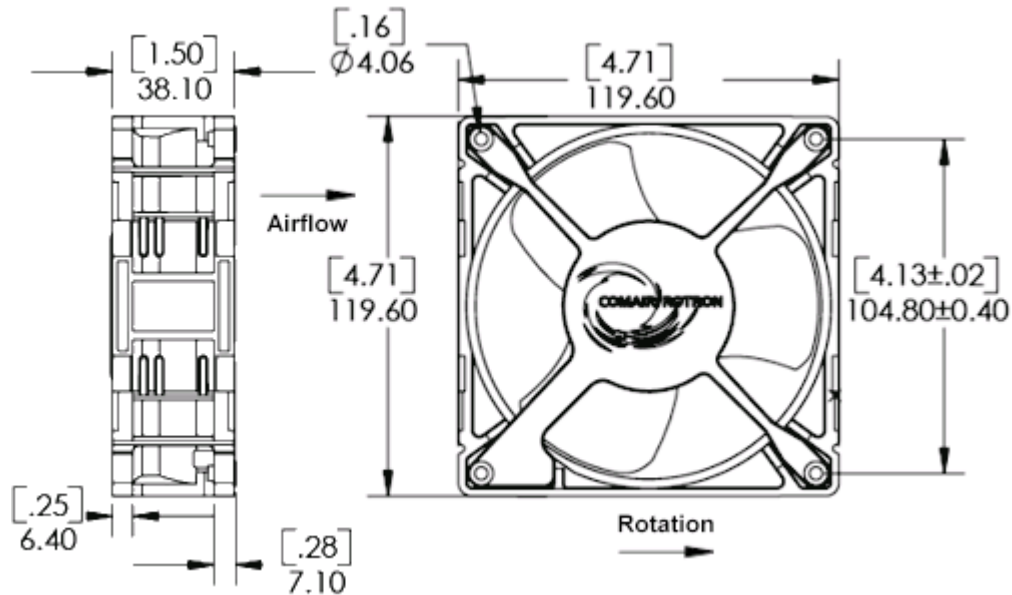

Options

Part Number	Model Number	Bearing Type	Fan Rotation	Termination	In-Stock <small>(Click 'Yes' for current stock)</small>
<input checked="" type="radio"/> 028027	MU2B1	Ball	Normal	Terminals	No
<input type="radio"/> 028028	MU2B2	Ball	Normal	Terminals, No Venturi	No
<input type="radio"/> 039666	MU2B4	Ball	Reverse	Terminals, No Venturi	No
<input type="radio"/> 028021	MU2A1	Sleeve	Normal	Terminals	No
<input type="radio"/> 028022	MU2A2	Sleeve	Normal	Terminals, No Venturi	No
<input type="radio"/> 027300	MU2A3	Sleeve	Reverse	Terminals	No
<input type="radio"/> 027301	MU2A4	Sleeve	Reverse	Terminals, No Venturi	No

Accessories (Click on part number for detailed drawing.)

428056
Plug and Cord

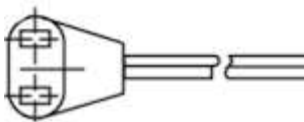

477663
Mounting Clip



551590
Filter Assembly

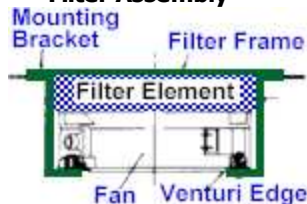

554148
Filter Guard Assembly

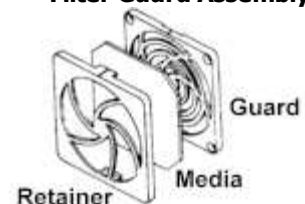

□ 552934
Finger Guard



□ 476042
Finger Guard

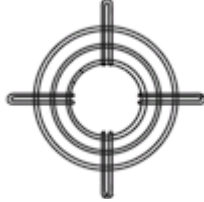

□ 550481
Finger Guard

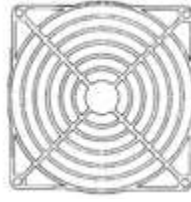

□ 551147
Finger Guard

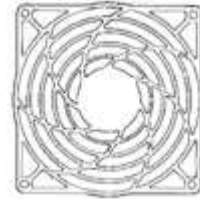

Comair Rotron, Inc.
Phone: 619.651.2000
sales@comairrotron.com

Comair Rotron Europe, Ltd.
Phone: +44.1527.520525
saleseurope@comairrotron.com

Comair Rotron Fan Company Ltd.
Phone: +86.21.52260581
salesasia@comairrotron.com

Print Date: Monday, March 22, 2010 at 11:14:04 - AC Fan Datasheet - Web Version 1.0 Rev. A