

Super-mini Signal Conditioners Mini-M Series

DC/FREQUENCY CONVERTER

Functions & Features

- Provides a pulse rate output in proportion to DC input signal
- CE marking
- UL approval

Typical Applications

- Totalizing applications in combination with a counter

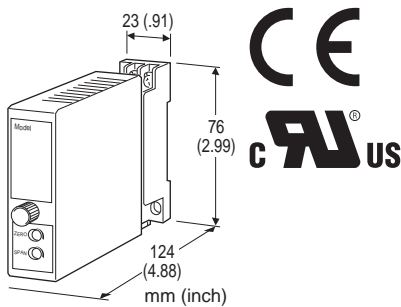

MODEL: M2AP-[1][2]-[3][4]

ORDERING INFORMATION

Specify a code from below for each [1] through [4].

- Code number: M2AP-[1][2]-[3][4]
(e.g. M2AP-61-M2/CE/Q)

Specify variables.

- Output frequency range (e.g. 0 - 500 Hz)
- Specify the specification for option code /Q
(e.g. /C01/S01)

[1] INPUT

Current

- A: 4 - 20 mA DC (Input resistance 250 Ω)
- D: 0 - 20 mA DC (Input resistance 50 Ω)
- G: 0 - 1 mA DC (Input resistance 1000 Ω)
- H: 10 - 50 mA DC (Input resistance 100 Ω)
- Z: Specify current (See INPUT SPECIFICATIONS)
(0 % input must be 0 mA.)

Voltage

- 3: 0 - 1 V DC (Input resistance 1 MΩ min.)
- 4: 0 - 10 V DC (Input resistance 1 MΩ min.)
- 5: 0 - 5 V DC (Input resistance 1 MΩ min.)
- 6: 1 - 5 V DC (Input resistance 1 MΩ min.)
- 0: Specify voltage (See INPUT SPECIFICATIONS)
(0 % input must be 0 V.)

[2] OUTPUT

- 1: Open collector (max. frequency 1 kHz)
- 2: 5 V pulse (max. frequency 1 kHz)
- 3: Mercury relay contact (max. frequency 30 Hz)
(Select '/N' for 'Standards & Approvals' code.)
(Not conformed to RoHS Directive)

[3] POWER INPUT

AC Power

M: 85 - 264 V AC (Operational voltage range 85 - 264 V, 47 - 66 Hz)

(Select '/N' for 'Standards & Approvals' code.)

M2: 100 - 240 V AC (Operational voltage range 85 - 264 V, 47 - 66 Hz)

(90 - 264 V for UL)

DC Power

R: 24 V DC

(Operational voltage range 24 V ±10 %, ripple 10 %p-p max.)

R2: 11 - 27 V DC

(Operational voltage range 11 - 27 V, ripple 10 %p-p max.)

(Select '/N' for 'Standards & Approvals' code.)

P: 110 V DC

(Operational voltage range 85 - 150 V, ripple 10 %p-p max.)

(Select '/N' for 'Standards & Approvals' code.)

[4] OPTIONS (multiple selections)

STANDARDS & APPROVALS (must be specified)

/N: Without CE or UL

/CE: CE marking

/UL: UL approval (CE marking)

OTHER OPTIONS

blank: none

/Q: Option other than the above (specify the specification)

(UL not available)

SPECIFICATIONS OF OPTION: Q (multiple selections)

COATING (For the detail, refer to M-System's web site.)

/C01: Silicone coating

/C02: Polyurethane coating

/C03: Rubber coating

TERMINAL SCREW MATERIAL

/S01: Stainless steel

GENERAL SPECIFICATIONS

Construction: Plug-in

Connection: M3 screw terminals (torque 0.8 N·m)

Housing material: Flame-resistant resin (black)

Isolation: Input to output to power

Zero adjustment: 0 - 5 % (front)

Span adjustment: 95 to 105 % (front)

INPUT SPECIFICATIONS

- **DC Current:**
Shunt resistor attached to the input terminals (0.5 W)
Specify input resistance value for code Z.
- **DC Voltage:** 0 - 300V DC
Minimum span: 1V
Input resistance: 1 MΩ min.

OUTPUT SPECIFICATIONS

- **Open Collector:** 30 V DC @100 mA (resistive load)
Frequency range: 0 - 10 pulses/hour through 1 kHz
Saturation voltage: 0.6 V DC
- **5 V Pulse**
Frequency range: 0 - 10 pulses/hour through 1 kHz
Hi level: 3.0 - 5.5 V
Lo level: ≤ 0.5 V
Load resistance: 250 Ω min.
- **Mercury Relay Contact**
Frequency range: 0 - 10 pulses/hour through 30 Hz
Timer: Limits ON time ≤ 75 ±25 millisec.
Rated load: 132 V AC @200mA (cos φ = 1)
30 V DC @200 mA (resistive load)
Maximum switching voltage: 350 V AC or 500 V DC
Maximum switching current: 200 mA AC or 300 mA DC
Maximum switching power: 26 VA or 6 W
Relay life: ≥ 5 × 10⁸ cycles, mechanical
≥ 5 × 10⁷ cycles, electrical

OUTPUT PULSE WIDTH

- **Frequency less than 500 Hz at 100% input**
→ Duty ratio 20% (See the figure below)

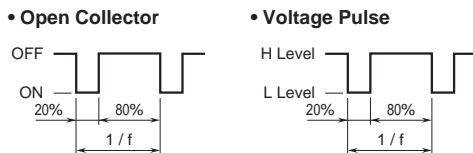

- **Frequency greater than 500 Hz at 100% input**
→ See the figure and equation below.

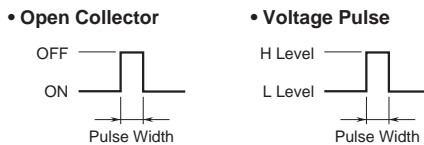

$$\text{Pulse Width [millisec.]} = \frac{1}{2.09 \times 100\% \text{ Frequency [kHz]}}$$

- **Mercury Relay Contact**
→ See the figure below. ON pulse width is limited within 75 ±25 ms when the output frequency is low.

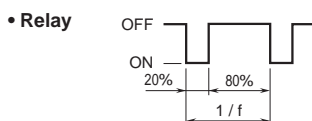

INSTALLATION

- Power Consumption**
- **AC Power input:**
Approx. 3 VA at 100 V
Approx. 4 VA at 200 V
Approx. 5 VA at 264 V
- **DC Power input:** Approx. 3 W
- Operating temperature:** -5 to +55°C (23 to 131°F)
- Operating humidity:** 30 to 90 %RH (non-condensing)
- Mounting:** Surface or DIN rail
- Weight:** 150 g (0.33 lbs)

PERFORMANCE in percentage of span

- Accuracy:** ±0.1 %
- Temp. coefficient:** ±0.015 %/°C (±0.008 %/°F)
- Response time:** Approx. 3 sec. (0 - 90 %)
- Line voltage effect:** ±0.1 % over voltage range
- Insulation resistance:** ≥ 100 MΩ with 500 V DC
- Dielectric strength:** 2000 V AC @1 minute (input to output to power to ground)

STANDARDS & APPROVALS

- CE conformity:**
EMC Directive (2004/108/EC)
EN 61000-6-4 (EMI)
EN 61000-6-2 (EMS)
Low Voltage Directive (2006/95/EC)
EN 61010-1
Installation Category II
Pollution Degree 2
Max. operating voltage 300 V
Input or output to power: Reinforced insulation
Input to output: Basic insulation

- Approval:**
UL/C-UL nonincendive Class I, Division 2,
Groups A, B, C, and D hazardous locations
(UL 1604, CAN/CSA-C22.2 No.213)
UL/C-UL general safety requirements
(UL 61010B-1, CAN/CSA-C22.2 No.1010-1)

DIMENSIONS unit: mm (inch)

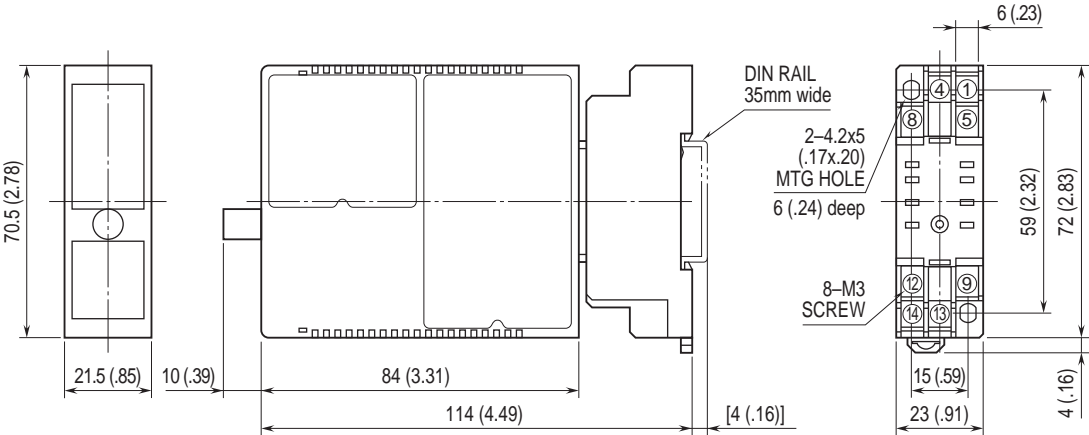

• When mounting, no extra space is needed between units.

TERMINAL ASSIGNMENTS unit: mm (inch)

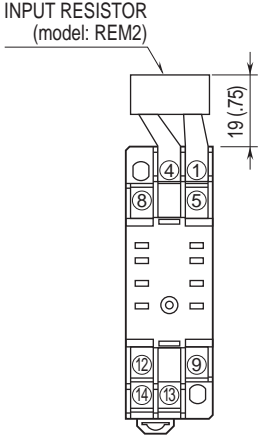

Input shunt resistor attached for current input.

SCHEMATIC CIRCUITRY & CONNECTION DIAGRAM

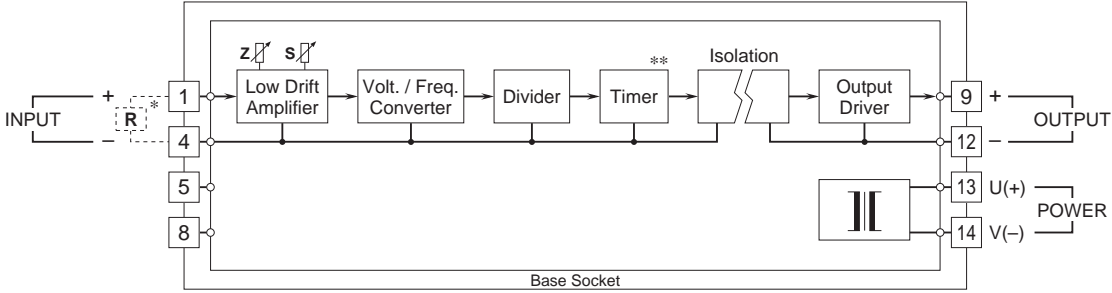

* Input shunt resistor attached for current input.
 **Mercury relay contact only.

Output Connection Examples

■ **Open Collector**

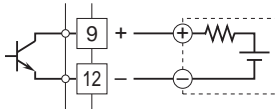

■ **Voltage Pulse**

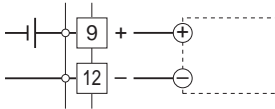

■ **Relay**

• **AC Powered**

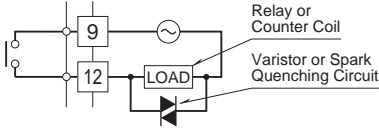

• **DC Powered**

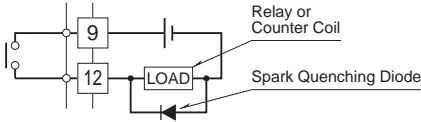

Specifications are subject to change without notice.