

**INPUT CHARACTERISTICS:****RHD-6400/6460P**

- VOLTAGE: 95 ~ 264 VAC FULL RANGE
- FREQUENCY : 47 ~ 63 Hz
- INPUT CURRENT: 8.0 / 4.0 A FOR 115 / 230 VAC PER MODULE
- INRUSH CURRENT: 65A / 125A MAX. FOR 115 / 230 VAC PER MODULE

**OUTPUT CHARACTERISTICS:**

OUTPUT VOLTAGE	OUTPUT CURRENT		REGULATION		OUTPUT
	MIN.[A]	MAX.[A]	LOAD	LINE	RIPPLE & NOISE MAX. [P-P]
5V	5.0	35/40	± 5%	± 1%	60mV
12V	2.5	20/32	± 5%	± 1%	100mV
-5V	0	0.8	± 5%	± 1%	100mV
-12V	0	1	± 5%	± 1%	100mV
3.3V	1.0	28/30	± 5%	± 1%	60mV
+5VSB	0.1	2.0	± 5%	± 1%	60mV

REMARKS: XX / XX : 400W / 460W;

TOTAL POWER OUTPUT NOT EXCEED 400 / 460W

- TEMPERATURE RANGE : OPERATING 0°C --- 40°C, STORAGE -20°C --- 70°C
- HOLD UP TIME: 16 ms MINIMUM AT FULL LOAD & NORMAL INPUT VOLTAGE
- DIELECTRIC WITHSTAND: INPUT / OUTPUT 1500 VAC FOR 1 MINUTE  
INPUT TO FRAME GROUND 1500 VAC FOR 1 MINUTE
- EFFICIENCY: 65% TYPICAL, AT FULL LOAD
- POWER GOOD SIGNAL: ON DELAY 100 ms TO 500 ms, OFF DELAY 1 ms
- OVER LOAD PROTECTION: 110 ~ 160% MAX.
- OVER CURRENT PROTECTION : 6 CHANNELS
- OPEN LOOP PROTECTION
- SHORT CIRCUIT PROTECTION
- DOUBLE OVER VOLTAGE PROTECTION:  
**+5V → 5.7V ~ 6.5V, 3.3V → 3.9 ~ 4.3V, 12V → 13.6 ~ 15V**
- EMI NOISE FILTER: FCC CLASS B, CISPR22 CLASS B
- SAFETY: UL 1950, CSA 22.2 NO/ 950, TÜV IEC 950
- REMOTE ON / OFF CONTROL
- FAULTY ALARM METHODS : LED, BUZZER, TTL SIGNAL
- HOT-SWAPPABLE / HOT-PLUGGABLE 1 + 1 REDUNDANCY FUNCTION
- BUILT-IN ACTIVE POWER FACTOR CORRECTOR
- DIMENSION: 213.2(H) X 153.4(W) X 183(D) mm--RHD;  
189(H) X 167(W) X 183(D) mm--RHI; 106(H) X 354(W) X 194.2(D) mm--RHH
- COOLING : TWO 80 mm DC FANS
- USED 48 PINS INDUSTRIAL CONNECTORS

修訂 REVISIONS		日期 DATE
版次 REV.	記號 DESCRIPTION	
A2	增加抽牙及訊號線孔	JAN-28-2002

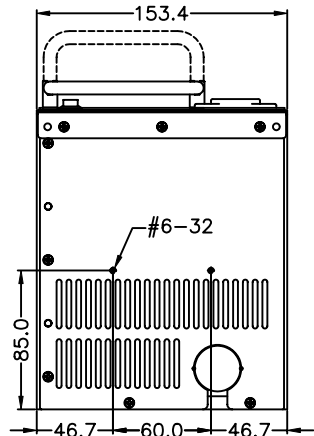
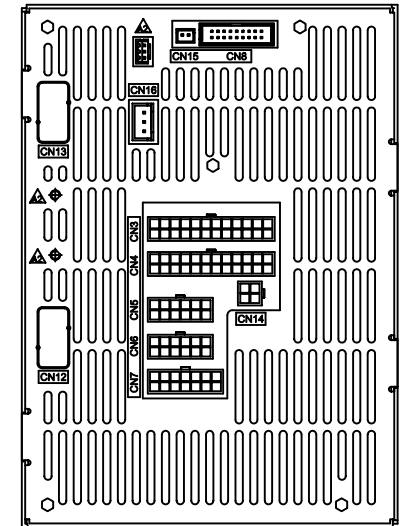
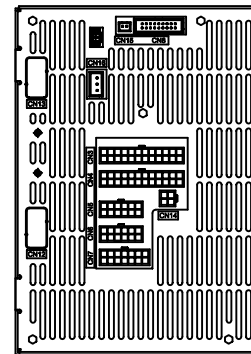
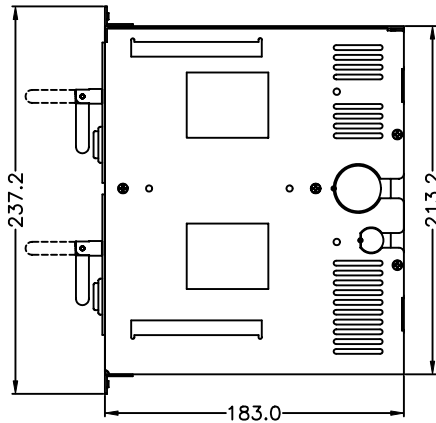
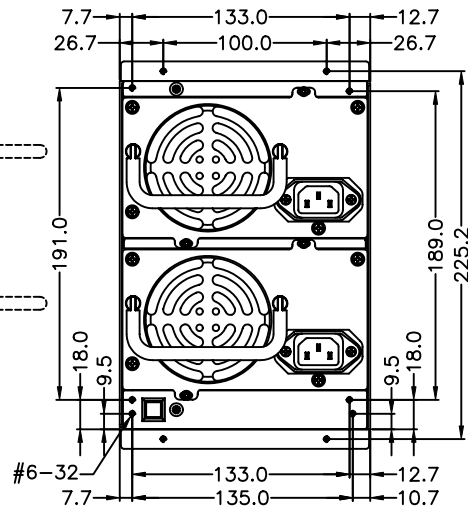
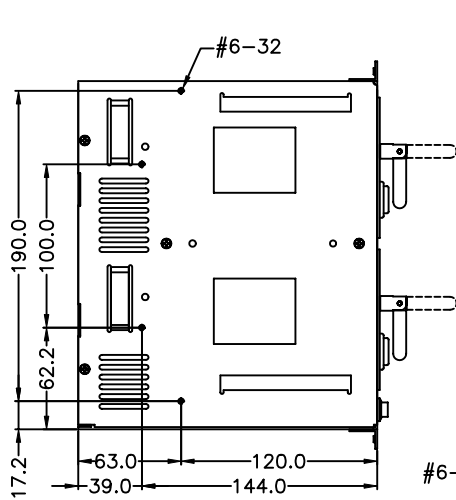
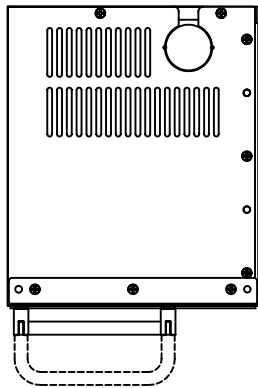

SCALE 1.5:1

容許公差:  
TOLERANCES:  
.XXX ±.025  
.XX ±.100  
.X ±.250

材料規格:  
MATERIAL:

核准者:  
APPROVE BY:

日期:  
DATE:

投影法:  
PROJECTION:  
第三角法

審核者:  
CHECK BY:  
繪圖者:  
DRAW BY:

日期:  
DATE:

JAN-28-2002

新巨企業股份有限公司  
ZIPPY TECHNOLOGY CORP.  
POWER DIVISION

品名:  
MODEL NO: RHD 外觀尺寸圖

料號:  
PART NO:

圖號: RHD0MA00 檔號: RHD0MA00  
DRAW NO: RHD0MA00 FILE NO: RHD0MA00

單位: mm 版次: A2 規格: A0 編號: OF  
UNITS: mm REV. NO: A2 SPEC: A0 SHEET: OF