

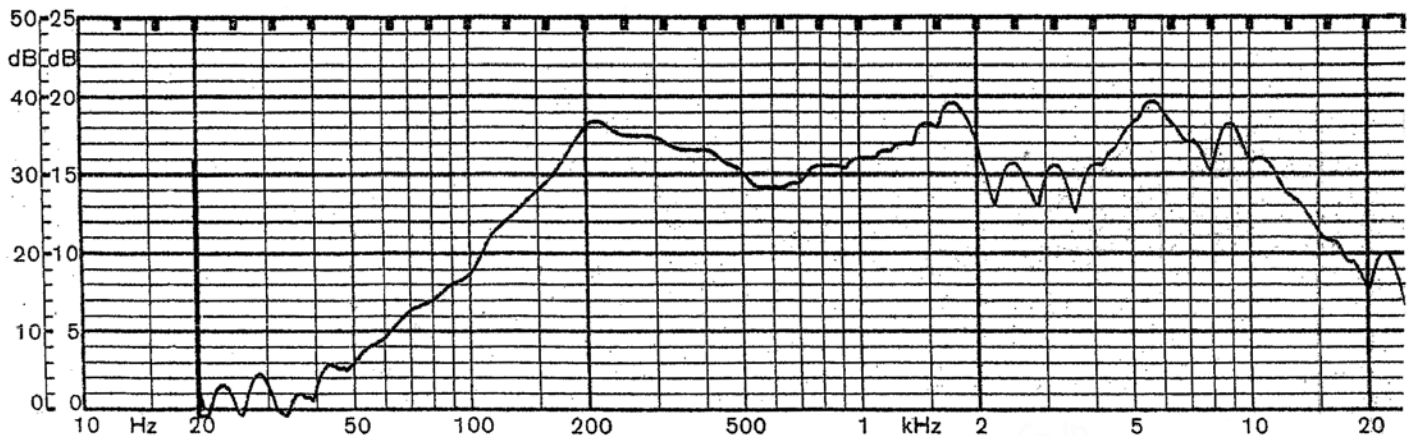

Specifications

Nominal Size	77 mm (3.00 in)	(See attached drawing)
Impedance	8 Ohm \pm 15%	at 800 Hz 1 V
Resonant frequency	190 Hz \pm 38 Hz	at 1 V
Sound pressure level	90 dB/w \pm 3 dB	1 w 50 cm ave. at 0.8K, 1.0K, 1.2K, 1.4K Hz
Response	Fo Hz ~ 7 KHz max 10 dB	
Input power	Nominal 1 W	Handling capacity 2 W
Operation	must be normal at program source 1 W	
Buzz, rattle, etc.	must be normal at sine wave 2.82 V	
Magnet	Size: 13 x 10 mm	
Load test	White noise 1 W	for 5 hours
Heat test	70 \pm 2° C	20-50% R.H. 5 hours
Humidity test	40 \pm 2° C	90-95% R.H. 5 hours

Frequency Response Curve

Potentiometer range	50 dB
Rectifier	RMS
Lower limit frequency	20 Hz
Wr. speed	100 mm/sec



Zero level 60 dB

REV.	DESCRIPTION	DATE
A	NEW DRAWING	9/15/2006

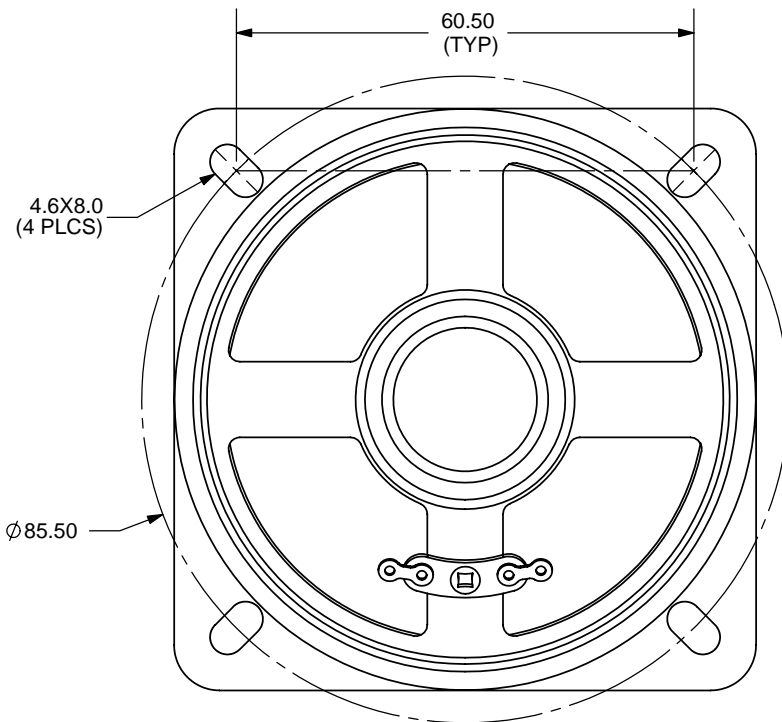
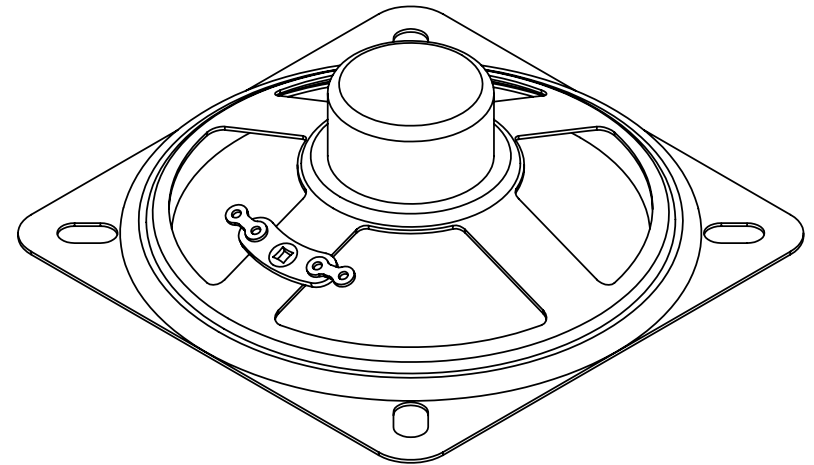
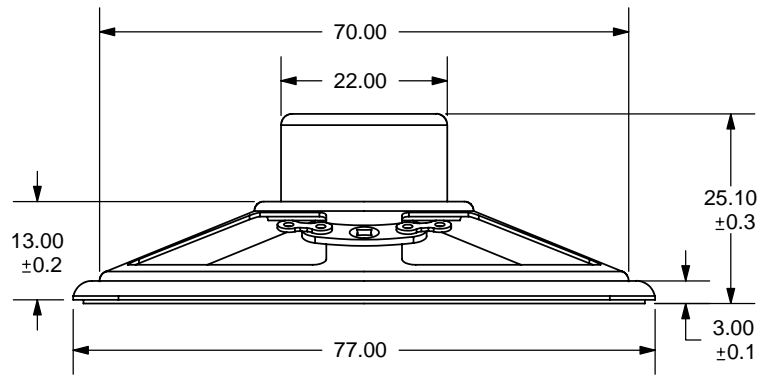

TOLERANCE:
±0.5mm UNLESS OTHERWISE
SPECIFIED



20050 SW 112th Ave.
Tualatin, OR 97062
Phone: 503-643-4899
800-275-4899
Fax: 503-372-1266
Website: www.cui.com

TITLE: Square frame paper cone - alnico magnet		REV: A
PART NO. GA0776	UNITS: MM [INCHES]	
DRAWN BY: ZRJ	APPROVED BY:	SCALE: 1:1

PC FILE NAME:
GA0776

COPYRIGHT 2006 BY CUI INC.