

MODEL TL-2450

TECHNICAL DATA

(Typical values @+25°C for batteries stored for one year or less)

■ Nominal capacity @ 0.5 mA, to 2V	0.55 Ah
■ Rated voltage	3.6 V
■ Maximum recommended continuous current	5 mA
■ Maximum pulse current capability	10 mA
■ Weight	8.8g (0.310 oz)
■ Volume	2.60 cc
■ Operating temperature range	-55°C to +85°C
■ Li metal content	approx. 0.2 g
■ U.L. Component Recognition MH 12193	

TADIRAN LITHIUM BATTERIES

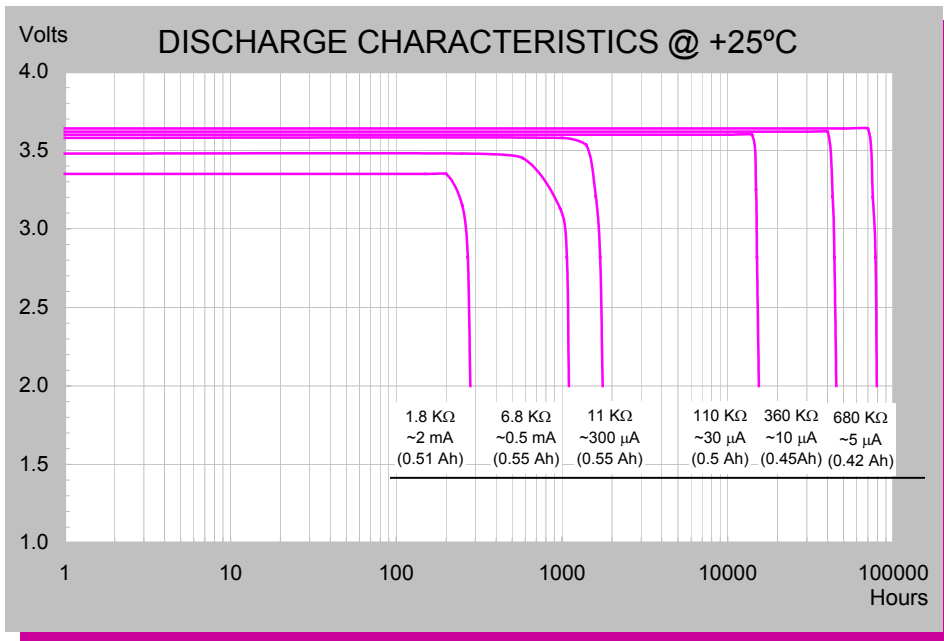
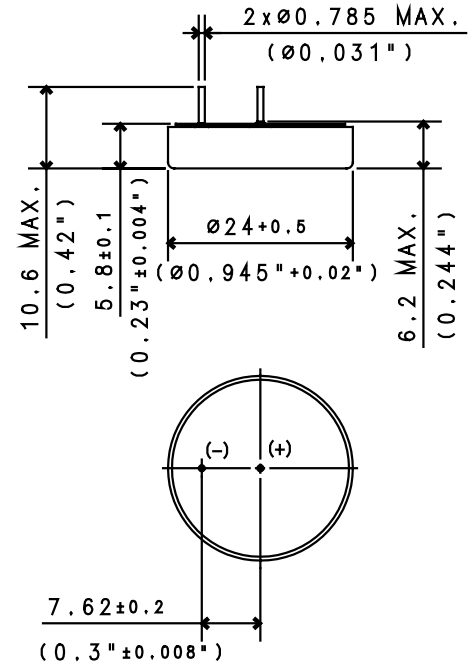

ADDITIONAL INFORMATION
 SUFFIX - /P TIN PLATED NICKEL PINS
 CATALOGUE NO.: 15-2450-41000

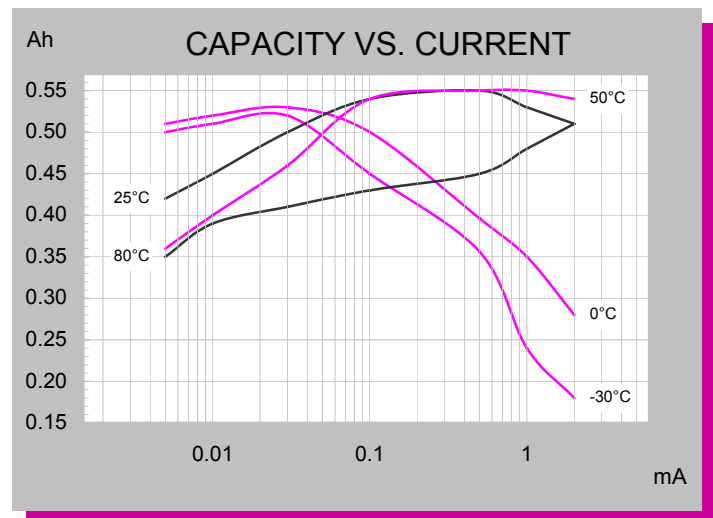
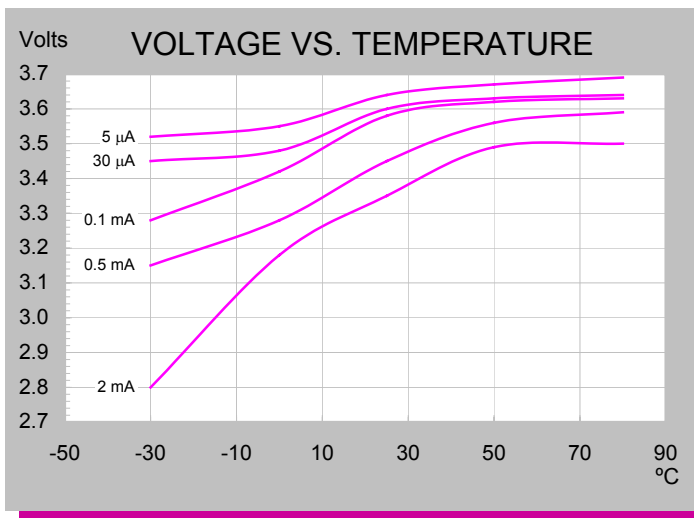

iXtra - Long Term High Performance

Note: Any presentations in this data sheet concerning performance are for information purpose only and are not construed as warranties either expressed or implied, of future performance. Rev. D 11/05

TL-2450

CELL FEATURES

- 3.6 V Primary lithium-thionyl chloride (Li-SOCl₂)
- Fast voltage recovery after long term storage and/or usage
- High energy density
- High and stable operating voltage
- Low self discharge rate
- 10 years shelf life
- Wafer construction
- Hermetic glass-to-metal-sealing
- Non-flammable electrolyte
- Non-restricted for transportation

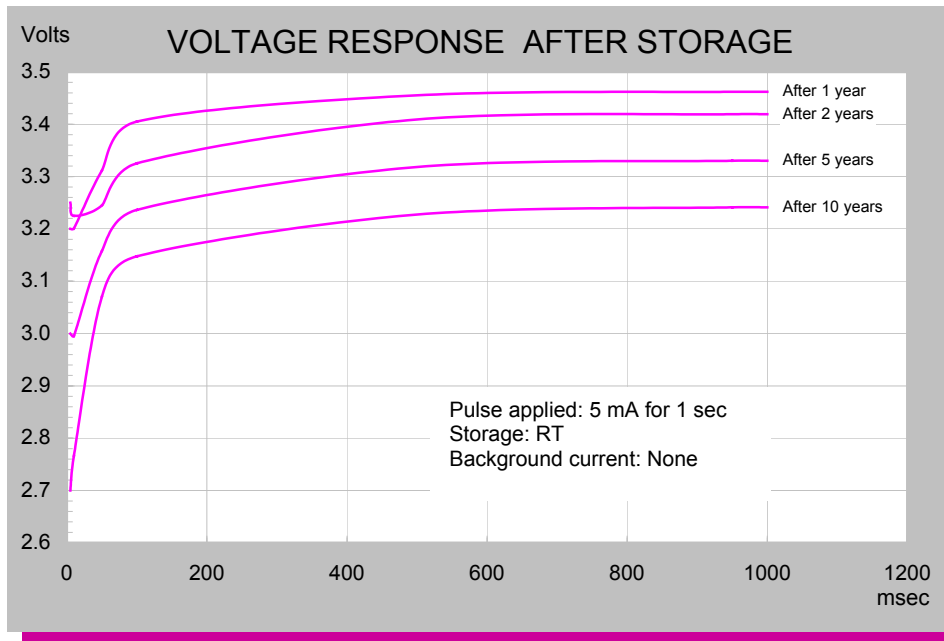

TADIRAN LITHIUM BATTERIES

MAIN APPLICATIONS

- Utility meters (elect., water & gas)
- Automatic meter reading
- RF systems
- Sensors & monitoring systems
- Tracking systems
- Wireless security systems
- Automotive electronics
- Industrial electronics
- Ultra Low Power (ULP) devices
- Others

STORAGE CONDITIONS

- Cells should be stored in a clean & dry (less than 30 % RH) area
- Temp. should not exceed +30 °C

For updated information please visit our website www.tadiranbat.com

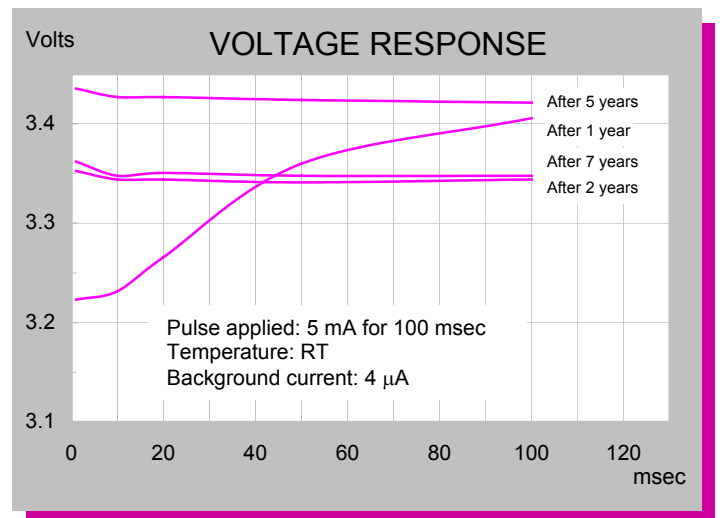
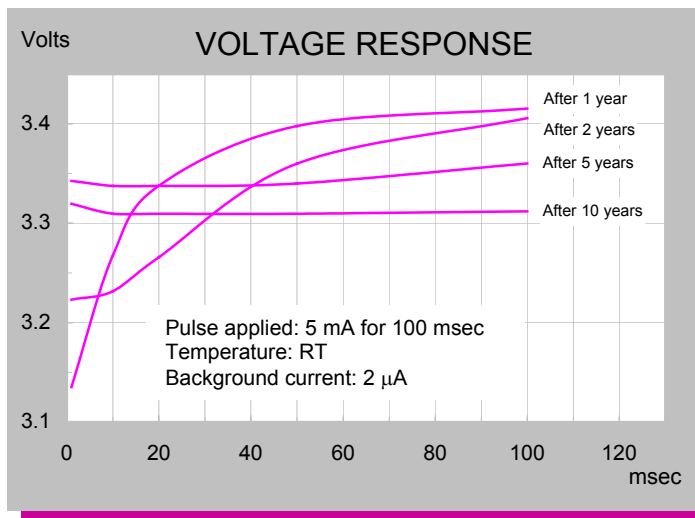

iXtra - Long Term High Performance

Note: Any presentations in this data sheet concerning performance are for information purpose only and are not construed as warranties either expressed or implied, of future performance. Rev. D 11/05