



- *Incandescent lamp emission*
- *Optic adjustment of the sensitivity*
- *8, 28 and 50 mm lenses available*
- *Dark/light mode selector*

## TL10 SERIES

The **TL10** series is composed of analog contrast sensors with incandescent lamp emission with long life and easy interchangeability.

The sensors present a mechanical multi-turn optic adjuster for the sensitivity regulation, a switch for the dark/light operating mode selection and a red LED that signals the NPN transistor output activation.

Different models are available with 8, 28 and 50 mm lenses.

The sensors of the **TL10** series and relative accessories are available as spare parts. Contrast sensors of the **TL $\mu$**  series are recommended for replacements, new applications and improved performances.

## TECHNICAL DATA

<b>Power supply:</b> .....	10 ... 30 Vdc, reverse polarity protection 4.5 Vac for lamp emission
<b>Consumption:</b> .....	50 mA max.
<b>Light emission:</b> .....	4.5 V (0,8 A) incandescent lamp
<b>Spot dimension:</b> .....	5 x 1 mm (8 mm lens) 6 x 2.5 mm (28 mm lens) 8 x 2.5 mm (50 mm lens)
<b>Operating distance:</b> .....	8 ... 12 mm (8 mm lens) 28 ... 36 mm (28 mm lens) 46 ... 54 mm (50 mm lens)
<b>Depth of field:</b> .....	±2 mm (8 mm lens) ±4 mm (28 and 50 mm lenses)
<b>Setting:</b> .....	mechanical multi-turn actuator
<b>Indicators:</b> .....	red OUTPUT LED
<b>Output type:</b> .....	NPN
<b>Saturation voltage:</b> .....	1.4 V max.
<b>Output current:</b> .....	100 mA max., short-circuit protection
<b>Response time:</b> .....	50 µs max.
<b>Switching frequency:</b> .....	10 KHz max.
<b>Operating mode :</b> .....	dark/light selectable
<b>Connection:</b> .....	3 m Ø 5.5 mm cable cable with Amphenol connector
<b>Electrical protection:</b> .....	class 1
<b>Mechanical protection:</b> .....	IP67
<b>Housing material:</b> .....	ZAMA
<b>Lens material:</b> .....	glass
<b>Weight:</b> .....	600 g max.
<b>Operating temperature:</b> .....	-10 ... +55°C
<b>Storage temperature:</b> .....	-20 ... +70°C
<b>Fibre operating temperature:</b> .....	-30 ... +60°C
<b>Reference standard:</b> .....	EN 60947-5-2
<b>Certifications:</b> .....	CE

## DETECTION DIAGRAMS

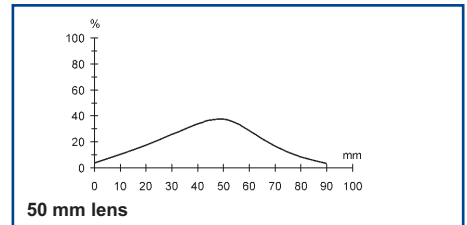
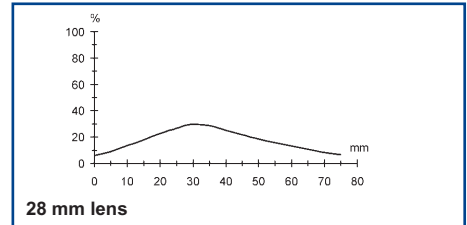
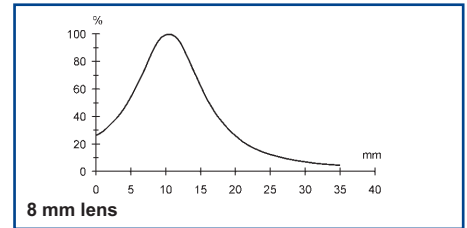

The operating distances indicate the detection distance with excess gain 2.

The detection diagrams indicate the typical operating distance with excess gain 1.

## CONNECTIONS

### CABLE VERSIONS

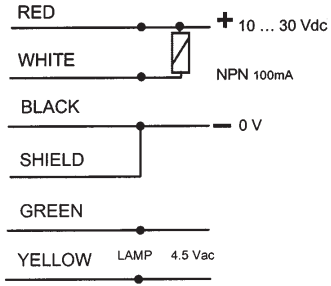

### AMPHENOL CONNECTOR VERSIONS

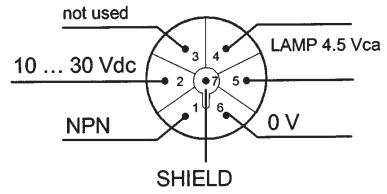

## DIMENSIONS

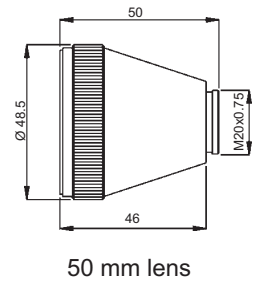
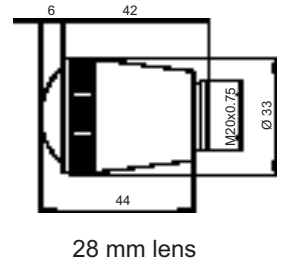
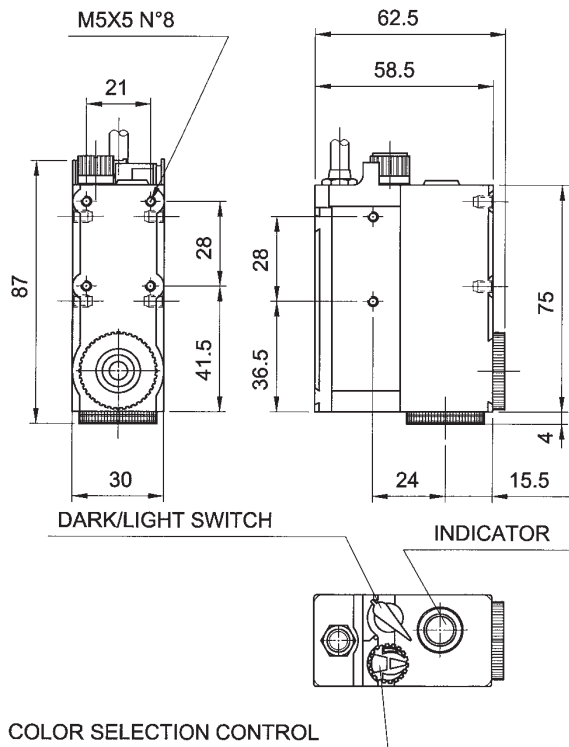

## MODEL SELECTION AND ORDER INFORMATION

MODEL	OPTICS	SPOT	CONNECTION	OUTPUT	CODE N°
TL10-011	8 mm	vertical	cable	NPN	S917660100
TL10-012	8 mm	vertical	Amphenol connector	NPN	S917660105
TL10-011L	8 mm	horizontal	cable	NPN	S917660102
TL10-021	28 mm	vertical	cable	NPN	S917660101
TL10-031	50 mm	vertical	cable	NPN	S917660103

## ACCESSORY SELECTION AND ORDER INFORMATION

MODEL	DESCRIPTION	CODE N°
010066	6V/6W lamp vertical spot (standard vers.)	S2600030
010067	6V/6W lamp horizontal spot (90° vers.)	S2610300

Please refer also to **Sensor Accessories**

The sensors of the **TL10** series and relative accessories are available as spare parts. Contrast sensors of the **TL $\mu$**  series are recommended for replacements, new applications and improved performances.

**Distributed by:**

### HEADQUARTERS

#### DATASENSOR SpA

via Lavino, 265 - 40050 Monte San Pietro, BO - Italy  
 Tel. +39 051/6765611 • Fax +39 051/6759324  
 www.datasensor.com • e-mail info@datasensor.com

Datasensor SpA endeavours to continuously improve and renew its products; for this reason the technical data and contents of this catalogue may undergo variations without prior notice. For correct installation and use Datasensor SpA can guarantee only the data indicated in the instruction manual supplied with the products.