

# FEATURED PRODUCT - SERIES RKW PROGRAMMABLE



**DIN-RAIL MOUNTABLE**

1500W, 600W and 300W RKW Models

The Programmable-Series RKW are industrial-grade single-output power supplies in the 300, 600 and 1500 watt sizes. They provide d-c outputs from 3.3 volts to 48 volts from a-c mains 85-265V a-c with power factor correction (PFC). They are fully enclosed, fan-cooled power supplies. All models feature overvoltage and overcurrent protection and remote error sensing and feature a remote on-off control, remote voltage trimming and master-slave paralleling with a current balance function. The RKW conform to EN60950 following the provisions of the Low Voltage Directive 73/23/EEC and 93/68/EEC for the CE mark. Conducted EMI is suppressed to FCC Class B, VCCI Class B, EN55011-B and EN55022-B. The 300 and 600 watt models meet the radiated noise limits of FCC Class B and EN55022 Class B. The RKW 1500 watt models meet the Class A limits for both conducted and radiated EMI, but can be upgraded to Class B with a noise filter, PN 245-0031. Consult factory for details.



**CE** RKW are CE marked per the Low Voltage Directive (LVD), EN60950.

## FEATURES

- Output indicator, green LED.
- Remote on-off logic control.
- Remote error sensing.
- Parallel operation for redundancy or to increase current.
- Current share circuitry to equalize current.
- Remote voltage programming by resistance.
- Remote voltage programming by voltage.
- Master-slave operation.
- Power fail logic signal.
- Thermal protection.
- Overvoltage protection.
- Overcurrent protection.
- Power factor corrected, wide-range a-c input.
- DIN-Rail mountable. For information, consult factory.

RKW Programmable modules can be individually installed or may be combined into a custom power assembly for multi-output requirements. Please see pages 131-135 for details on Kepco's Power Assembly Program.



## RKW PROGRAMMABLE MODEL TABLE

MODEL	OUTPUT	ADJUSTMENT RANGE	OVP SETTING (1)	OUTPUT CURRENT	CURRENT LIMIT	SHORT CIRCUIT CURRENT	SWITCHING RIPPLE	NOISE	EFFICIENCY (%) TYPICAL	
	Volts		Volts	Amps -10 to +50°C	Amps(2)	Amps	mV p-p	mV p-p(3)	100V a-c	200V a-c
<b>300 WATT MODELS</b>										
RKW 3.3-70K	3.3	1.8-3.6	3.96-4.62	70	73.5-91	90	80	120	68	72
RKW 5-60K	5	3.5-6.0	6.0-7.0	60	63.0-78.0	82	80	120	74	78
RKW 12-27K	12	7.2-14.4	14.4-16.8	27	28.4-35.1	35	120	150	76	80
RKW 15-22K	15	10.5-18.0	18.0-21.0	22	23.1-28.6	29	120	150	77	81
RKW 24-14K	24	16.8-28.8	28.8-33.6	14	14.7-18.2	20	150	200	80	84
RKW 28-12K	28	19.6-33.6	33.6-38.4	12	12.6-15.6	17	150	200	80	84
RKW 48-7K	48	33.6-52.8	50.5-58.0	7	7.4-9.1	11	200	300	81	85
<b>600 WATT MODELS</b>										
RKW 3.3-150K	3.3	1.8-3.6	3.96-4.62	150	156-186	180	80	120	74	78
RKW 5-120K	5	3.5-6.0	6.0-7.0	120	126-156	160	80	120	76	81
RKW 12-53K	12	7.2-14.4	14.4-16.8	53	55.6-68.9	65	150	200	80	84
RKW 15-43K	15	10.5-18.0	18.0-21.0	43	45.1-55.9	55	150	200	81	85
RKW 24-27K	24	16.8-28.8	28.8-33.6	27	28.3-35.1	35	200	300	82	86
RKW 28-23K	28	19.6-33.6	33.6-38.4	23	24.1-29.8	29	200	300	82	86
RKW 48-13K	48	33.6-52.8	52.8-60.0	13	13.7-16.9	19	300	400	84	87
<b>1500 WATT MODELS</b>										
RKW 3.3-375K	3.3	1.8-3.6	3.96-4.62	375	390-430	430	100	200	73	77
RKW 5-300K	5	3.5-6.0	6.0-7.0	300	315-350	350	100	200	77	82
RKW 12-125K	12	7.2-14.4	14.4-16.8	125	130-140	152	150	200	80	84
RKW 15-100K	15	10.5-18.0	18.0-21.0	100	105-115	135	150	200	82	86
RKW 24-65K	24	16.8-28.8	28.8-33.6	65	68-72	80	200	300	82	86
RKW 28-55K	28	19.6-33.6	33.6-38.4	55	57.7-63.2	70	200	300	82	86
RKW 48-32K	48	33.6-52.8	52.8-60.0	32	33.6-36.8	45	300	400	84	88

- (1) An overvoltage shuts down the output. Recover by resetting the RC terminals. The overvoltage setting tracks the REF voltage.  
 (2) The current limit is rectangular. If overcurrent persists for more than 30 seconds, the output shuts down. Reset by resetting the RC terminals.  
 (3) Bandwidth 100MHz. Ripple and noise will be approximately 1.5 times these values in the operating temperature range -10-0°C.  
 The ripple and noise values tabulated are valid when the output is derated as shown in figure 1 from 50-65°C.

### PROGRAMMABLE POWER 300-1500 WATTS

The new Kepco RKW Programmable power supplies are more than high-efficiency switch-mode boxes. Beyond their wide-range a-c (or d-c) input, beyond their power factor correction (PFC) to reduce harmonic corruption of the a-c mains, beyond the current-share capacity that allows multi-unit paralleling, the RKW are **fully programmable** by either external voltage (0-5V) or by resistance.

The output will track the programming signal with remarkable fidelity as the traces to the right show. Of course, the RKW have large output capacitors so the time constant will depend upon load – and at very light loads or no load, the discharge response will be slow.

Note particularly the linearity of the RKW power supply's response to square and triangular programming inputs. A 0-5V signal programs the output from 0 to maximum output. A 0-5.5V programming signal will control the RKW to 10% over the rated nominal output.

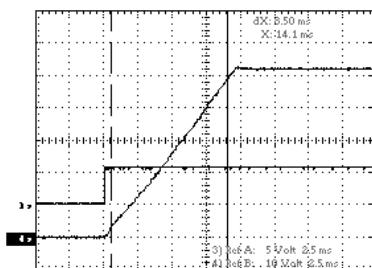

Output voltage from 0V goes to 52.8V (CH2)  
Rising Time = 8.50 mS

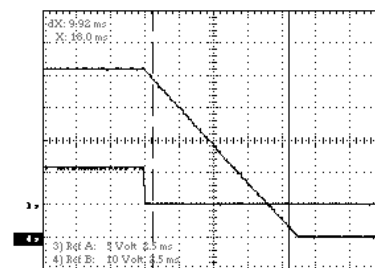

Output voltage from 52.8V goes to 0V (CH2)  
Falling Time = 9.92 mS

## RKW PROGRAMMABLE GENERAL SPECIFICATIONS

SPECIFICATION		RATING/DESCRIPTION	CONDITION
Temperature	Operating	-10 to +50°C	See rating curves, figure 1
	Start up	-20 to -10°C	
	Storage	-30 to +75°C	
Humidity	Operating	10 to 95% RH	Wet bulb temperature <35°C No condensation
	Storage	10 to 95% RH	
Vibration	5-10Hz	10mm amplitude	Sweep time 10 min. 1 hr each axis, not operating
	10-200Hz	2g	
Shock	Acceleration	30g 1/2 sine pulse duration 11 ±5 msec	3 shocks each axis, not operating
Withstand Voltage	Input-Output	a-c 3.0KV 1 min.	Cutout current <sup>(1)</sup>
	Input-Ground	a-c 2.0KV 1 min.	Cutout current <sup>(1)</sup>
	Output-Ground	a-c 500V 1 min.	Cutout current <sup>(1)</sup>
Insulation Resistance	Input-Output	>100MΩ	500V d-c <sup>(2)</sup>
	Input-Ground	>100MΩ	500V d-c <sup>(2)</sup>
	Output-Ground	>100MΩ	500V d-c <sup>(2)</sup>
Safety Standards		UL1950	Certified by UL
		CSA C22.2 No. 950-95	
		EN 60950	Certified by TÜV

(1) Cutout current: 300 and 600W models = 100mA; 1500W models = 300mA.

(2) Normal temperature (15-35°C) and humidity (10% -85% RH).

## RKW FUNCTIONS

DESCRIPTION	300W	600W	1500W
Oversvoltage	yes	yes	yes
Overcurrent	yes	yes	yes
Thermal Protection	yes	yes	yes
PFC	yes	yes	yes
Remote On-Off	yes	yes	yes
External Voltage Adjust	yes	yes	yes
Remote Sense	yes	yes	yes
Parallel Operation	yes	yes	yes
Master-Slave Operation	yes	yes	yes
Series Operation	yes	yes	yes
Current Balance	yes	yes	yes
Operation Indicator	yes	yes	yes
Power Fail Alarm	yes	yes	yes
Fan	yes	yes	yes (two)

**FIGURE 1**  
Output Power vs. Ambient Temperature  
300, 600, 1500W Models

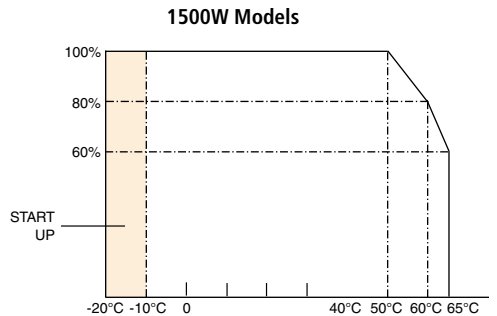
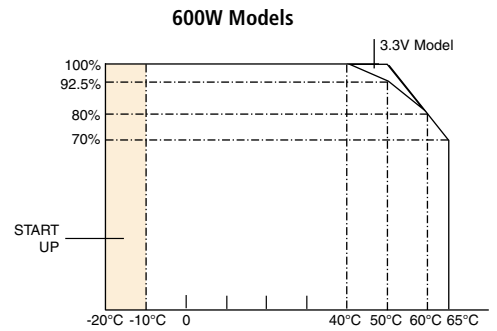
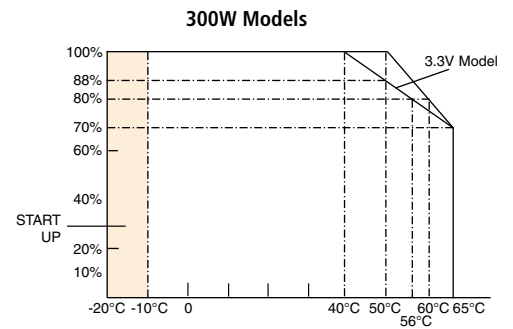



Model RKW 12-27K  
300 Watts



Model RKW 48-13K  
600 Watts



Model RKW 12-125K  
1500 Watts

### RKW PROGRAMMABLE COMMON INPUT CHARACTERISTICS

SPECIFICATIONS	RATING/DESCRIPTION	CONDITION
Input Voltage Range	85-265V a-c 110-370V d-c <sup>(2)</sup>	0-100% load, -10 to +50°C
Input Frequency Range	47-66Hz	0-100% load, -10 to +50°C
EMI Conducted Noise <sup>(1)</sup>	FCC Class B, VCCI-Class B EN55011-B, EN55022-B	300-600W models. 1500W models require noise filter: PN 245-0031
	Radiated Noise <sup>(1)</sup>	
Immunity To Electrostatic Discharge (ESD)	EN61000-4-2 Level 4	Normal operation
Radiated Susceptibility	EN61000-4-3 Level 3	Normal operation
Electrical Fast Transient	EN61000-4-4 Level 3	Normal operation
Surge Withstand	EN61000-4-5 Level 4	No damage
Conducted Susceptibility	EN61000-4-6 Level 3	Normal operation
Power Freq Mag Field	EN61000-4-8 Level 4	Normal operation
Voltage Dips, Short Interruptions and Voltage Variations	EN61000-4-11	Normal operation
Input Harmonics	EN61000-3-2	

- (1) The 300 and 600W RKW meet radiated and conducted FCC Class B and EN55022 Class B limits. The RKW 1500W models meet radiated and conducted FCC Class A and EN55022 Class A. The radiated and conducted emissions of the 1500W models are reduced to the Class B level by the use of a noise filter, PN 245-0031. Consult factory.
- (2) Safety agency approval applies only to a-c input operation.

### RKW PROGRAMMABLE MODEL-SPECIFIC INPUT CHARACTERISTICS

SPECIFICATION	CONDITION	300W	600W	1500W
Input Current Amps	100-120V a-c	4.4	8.4	22
	200-240V a-c	2.2	4.2	11
(5V-48V models)				
Input Current Amps	100-120V a-c	3.6	7.2	18
	200-240V a-c	1.8	3.6	9
(3.3V models)				
Surge Current Amps, typ <sup>(1)</sup>	120V a-c	20	30	20
	240V a-c	40	60	40
Fuse Value Amps		10	15	30
Switching Frequency		200KHz	140KHz	140KHz <sup>(2)</sup>
Leakage Current typ (mA)	120V a-c	0.24	0.45	0.5
	240V a-c	0.31	0.6	1.1
Leakage Current max (mA)	120V a-c	0.3	0.75	0.8
	240V a-c	0.38	0.75	1.6
Power Factor	120V a-c	0.99	0.99	0.99
	240V a-c	0.99	0.95	0.95

- (1) First surge only, not including the current flow into the EMI filter.
- (2) Model RKW 3-375K: 100KHz.



## RKW PROGRAMMABLE COMMON OUTPUT CHARACTERISTICS

SPECIFICATIONS		RATING/DESCRIPTION	CONDITION
Source Effect	typ	0.1% (1)	85-132 or 170-265V a-c
	max	0.2% (1)	
Load Effect	typ	See model specific output ratings	0-100% load
Temperature Effect	typ	0.5%	-10°C to +65°C
	max	1.0%	
Combined Effect	typ	±0.9% (2)	Source, load and temperature
	max	±1.8% (2)	
Time Effect (drift)	typ	0.2%	0.5-8 hours
	max	0.5%	
Transient Recovery Characteristic	Excursion	±4% maximum	50-100% load transient time >50µsec
	Recovery	1millisecond max	
Start Up Time	100V a-c	See model specific output ratings	
Hold Up Time	100V a-c	See model specific output ratings	
Remote Error Sensing	3.3V models	0.15V	Voltage compensation per line
	5V models	0.25V	
	12-48V models	0.4V	

(1) 3.3V models: 600 and 1500W: 0.15% typ, 0.3% max; 300W: 5mV typ, 10mV max.

(2) 3.3V models: 600 and 1500W: ±1.1% typ, ±2.2% max.

## RKW PROGRAMMABLE MODEL-SPECIFIC OUTPUT CHARACTERISTICS

SPECIFICATION	CONDITION	300W	600W	1500W
Load Effect	typ	0.2%	0.3%	0.3%
	max	0.4%(2)	0.6%(1)	0.6%(1)
Start Up Time typ msec	100V a-c	280	280	280
	240V a-c	150	100	180
Start Up Time max msec	100V a-c	350	350	500
	240V a-c	210	150	400
Hold Up Time typ msec	100V a-c	30	30	35
	240V a-c	40	40	40
Hold Up Time min msec	100V a-c	20	20	20
	240V a-c	20	20	20

(1) 3.3V models: 0.45% typ, 0.9% max.

(2) 3.3V models: 10mV typ, 20mV max.

## RKW PROGRAMMABLE MECHANICAL SPECIFICATIONS

SPECIFICATION		300W	600W	1500W
Dimensions English	Height	3.62"	3.62"	3.62"
	Width	3.15"	4.72"	7.48"
	Length	6.89"	7.87"	11.81"
Dimensions Metric	Height	92mm	92mm	92mm
	Width	80mm	120mm	190mm
	Length	175mm	200mm	300mm
Weight	English	3.96 lb.	6.6 lb.	13.2 lb.
	Metric	1.8Kg	3.0Kg	6.0Kg
Cooling		1 fan		2 fans
Mounting		3 surface (see figure 2)		

FIGURE 2  
Mounting Directions  
300, 600, 1500W Models

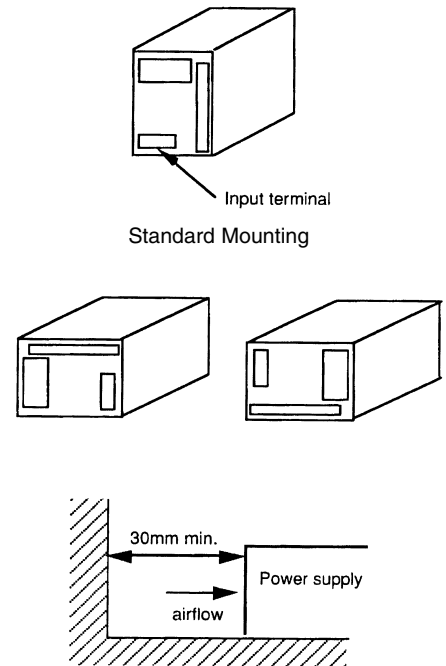

The fan should be situated at intervals of 30mm min. from other equipment in a well ventilated area.

## OUTLINE DIMENSIONAL DRAWINGS

Fractional dimensions in light face type are in inches, **dimensions in bold face type are in millimeters.**

### RKW 300W Models

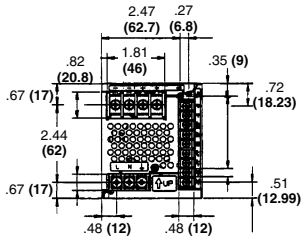

FRONT VIEW

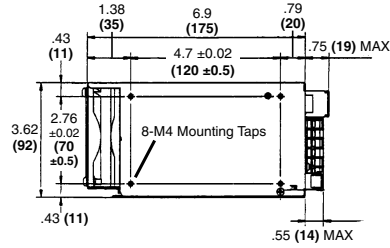

SIDE VIEW

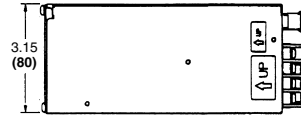

TOP VIEW

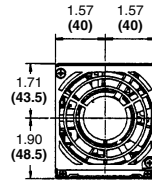

REAR VIEW

### RKW 600W Models

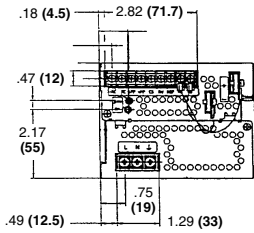

FRONT VIEW

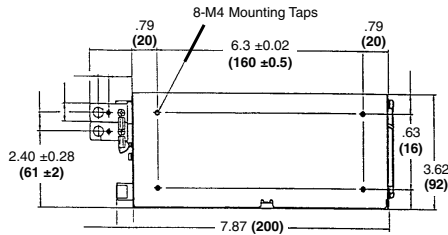

SIDE VIEW

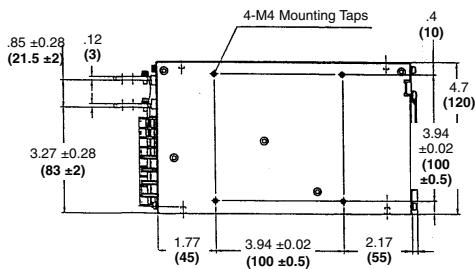

TOP VIEW

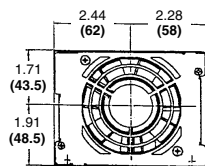

REAR VIEW

### RKW 1500W Models

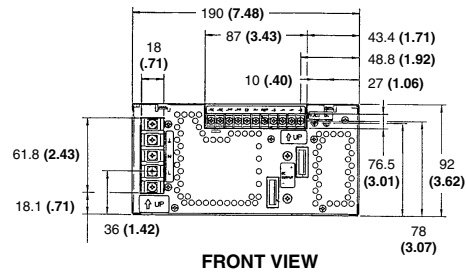

FRONT VIEW

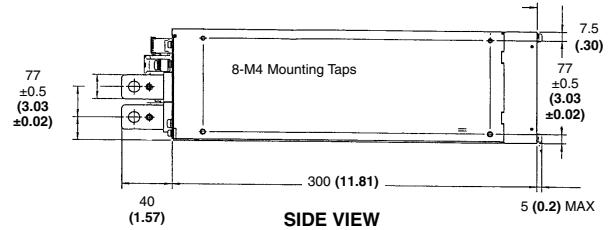

SIDE VIEW

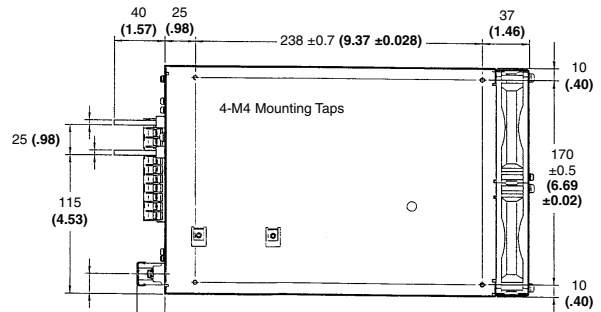

TOP VIEW

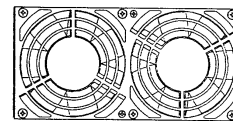

REAR VIEW

