



Document Version: 0.2
Date: 2006/02/06

Product Functional Specification

20.1 inch WSXGA+ Color TFT LCD Module
Model Name: M201EW01 V3

Preliminary Specification
 Final Specification



Note: This Specification is subject to change without notice.

AU OPTRONICS CORPORATION

Product Specification

20.1" Wide SXGA+ Color TFT-LCD Module

Model Name: M201EW01 V.3

Approved by	Prepared by
<i>CCChiu</i>	<i>Chris Peng</i>

DDBU Marketing Division / AU Optronics corporation

Customer	Checked & Approved by

Contents

1.0 Handling Precautions	6
2.0 General Description	7
2.1 Display Characteristics.....	7
2.2 Optical Characteristics.....	8
3.0 Functional Block Diagram	12
4.0 Absolute Maximum Ratings	13
4.1 TFT LCD Module.....	13
4.2 Backlight Unit.....	13
4.3 Absolute Ratings of Environment.....	13
5.0 Electrical characteristics	14
5.1 TFT LCD Module.....	14
5.1.1 Power Specification.....	14
5.1.2 Signal Electrical Characteristics.....	15
5.2 Backlight Unit.....	16
6.0 Signal Characteristic	17
6.1 Pixel Format Image.....	17
6.2 The input data format.....	17
6.3 Signal Description.....	18
6.4 Timing Characteristics.....	19
6.4.1 Timing diagram.....	20
6.5 Power ON/OFF Sequence.....	21
7.0 Connector & Pin Assignment	22
7.1 TFT LCD Module.....	22
7.2 Backlight Unit.....	23
7.3 Signal for Lamp connector.....	23
8.0 Reliability	25
9.0 Environment	26
9.1 Temperature and Humidity.....	26
9.1.1 Operating Conditions.....	26
9.1.2 Shipping Conditions.....	26
9.2 Atmospheric Pressure.....	26
10.0 Safety	27
10.1 Sharp Edge Requirements.....	27
10.2 Materials.....	27
10.2.1 Toxicity.....	27
10.2.2 Flammability.....	27



10.3 Capacitors 27

11.0 Other requirement 28

11.1 National Test Lab Requirement..... 28

11.2 Label 28

12.0 Mechanical Characteristics 29

--	--	--	--	--

1.0 Handling Precautions

- 1) Since front polarizer is easily damaged, pay attention not to scratch it.
- 2) Be sure to turn off power supply when inserting or disconnecting from input connector.
- 3) Wipe off water drop immediately. Long contact with water may cause discoloration or spots.
- 4) When the panel surface is soiled, wipe it with absorbent cotton or other soft cloth.
- 5) Since the panel is made of glass, it may break or crack if dropped or bumped on hard surface.
- 6) Since CMOS LSI is used in this module, take care of static electricity and insure human earth when handling.
- 7) Do not open nor modify the Module Assembly.
- 8) Do not press or pat the panel surface by fingers, hand or tooling
- 9) Do not press the reflector sheet at the back of the module to any directions.
- 10) In case if a module has to be put back into the packing container slot after once it was taken out from the container, do not press the center of the CCFL reflector edge. Instead, press at the far ends of the CCFL reflector edge softly. Otherwise the TFT module may be damaged.
- 11) At the insertion or removal of the Signal Interface Connector, be sure not to rotate nor tilt the Interface Connector of the TFT module.
- 12) After installation of the TFT module into an enclosure (Desktop monitor Bezel, for example), do not twist nor bend the TFT Module even momentary. At designing the enclosure, it should be taken into consideration that no bending/twisting forces are applied to the TFT module from outside. Otherwise the TFT module may be damaged.

2.0 General Description

This specification applies to the 20.1 inch-wide Color TFT-LCD Module M201EW01.

The display supports the WSXGA+ (1680(H) x 1050(V)) screen format and 16.7M colors (RGB 8-bits data).

All input signals are 2 Channel LVDS interface compatible.

This module does not contain an inverter card for backlight.

2.1 Display Characteristics

The following items are characteristics summary on the table under 25 °C condition:

ITEMS	Unit	SPECIFICATIONS
Screen Diagonal	[mm]	511.13 (20.1"Wide)
Active Area	[mm]	433.44 (H) x 270.90(V)
Pixels H x V		1680(x3) x 1050
Pixel Pitch	[mm]	0.258 (per one triad) x 0.258
Pixel Arrangement		R.G.B. Vertical Stripe
Display Mode		Normally Black by AUO AMVA
White Luminance (Center)	[cd/m ²]	300 cd/m ² @7mA (Typ)
Contrast Ratio		1000 : 1 (Typ)
Optical Response Time	[msec]	16ms (Typ, on/off) ; 8ms (Average, grey to grey)
Color Saturation		72% NTSC
Nominal Input Voltage VDD	[Volt]	+12 V
Power Consumption (VDD line + CCFL line)	[Watt]	30W(Typ) (w/o Inverter, All white pattern)
Weight	[Grams]	2950 (Typ)
Physical Size	[mm]	459.4(W) x 296.4(H) x 22.8(D) (Typ)
Electrical Interface		Even/Odd R/G/B data, 3 sync signal, Clock
Support Color		16.7M colors (RGB 8-bit data)
Temperature Range		
Operating	[°C]	0 to +50
Storage (Shipping)	[°C]	-20 to +60
Surface Treatment		Hard-coating (3H), Anti-Glare treatment

2.2 Optical Characteristics

The optical characteristics are measured under stable conditions at 25 °C:

Item	Unit	Conditions	Min.	Typ.	Max.	Note
Viewing Angle	[degree]	Horizontal (Right)	75	89	-	
	[degree]	CR = 10 (Left)	75	89	-	
	[degree]	Vertical (Up)	75	89	-	
	[degree]	CR = 10 (Down)	75	89	-	
Contrast ratio		Normal Direction	750	1000		
Response Time	[msec]	Rising Time	-	11	25	Note 1
	[msec]	Falling Time	-	5	15	Note 1
	[msec]	Rising + Falling	-	16	40	Note 1
	[msec]	Grey to Grey (average)	-	8	-	Note 2
Color / Chromaticity Coordinates (CIE)		Red x	0.610	0.641	0.670	
		Red y	0.322	0.353	0.382	
		Green x	0.258	0.289	0.318	
		Green y	0.598	0.626	0.658	
		Blue x	0.114	0.142	0.174	
		Blue y	0.046	0.078	0.106	
Color Coordinates (CIE) White		White x	0.283	0.313	0.343	
		White y	0.299	0.329	0.359	
White Luminance at CCFL 7.0mA (central point)	[cd/m ²]		240	300	-	
Luminance Uniformity	[%]		75	80	-	Note 3
Crosstalk (in75Hz)	[%]				1.5	Note 4
Flicker	DB				-20	Note 5

Equipment: Pattern Generator, Power Supply, Digital Voltmeter, Luminance meter (PR 880, BM-5A , BM 7 ,CS-1000, & EZContrast*)

Aperture : 1° with 100cm viewing distance (VD) or 2° with 50cm viewing distance (VD)

Test Point: Center (VESA point 9)

Environment: < 1 lux

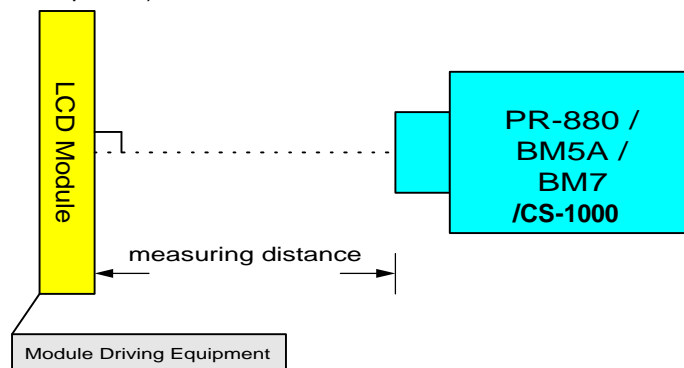

*1 EZ Contrast is different measurement tool with very close viewing distance.

Note 1: Definition of Response time

The output signals of photodetector are measured when the input signals are changed from “Black” to “White” (rising time), and from “White” to “Black” (falling time), respectively. The response time is interval between the 10% and 90% of amplitudes.

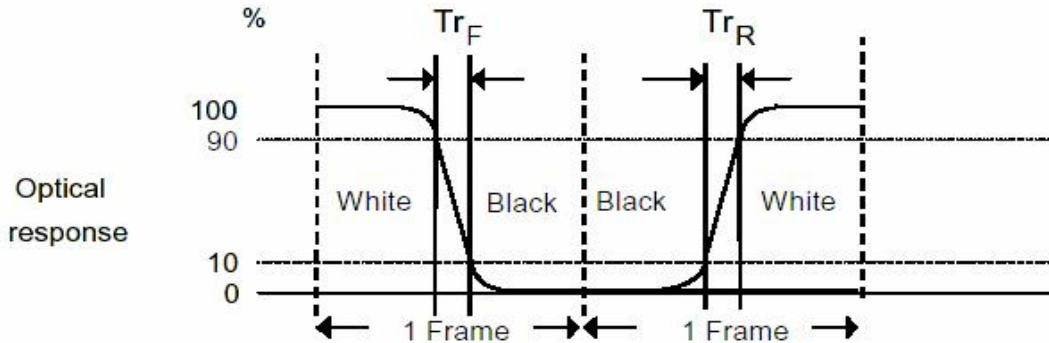

Note 2: Over-Drive and Response time:

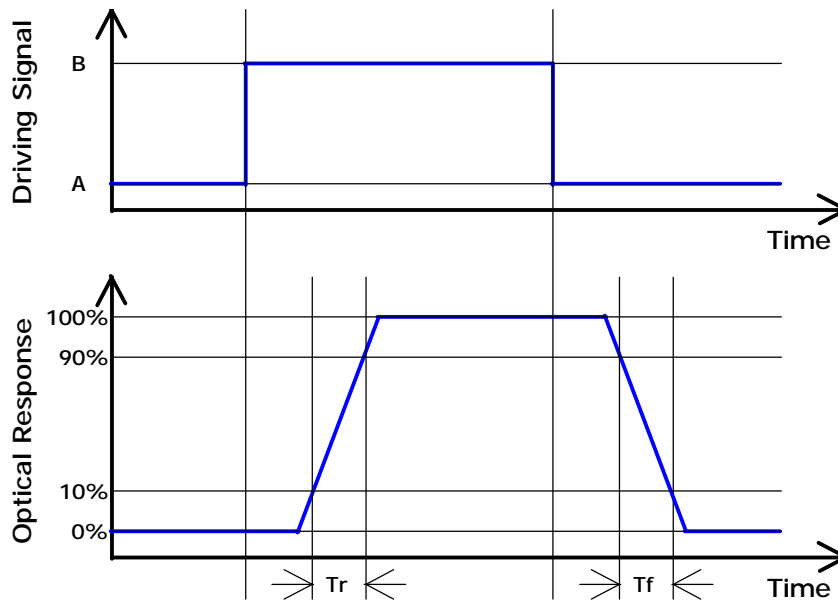

Algorithm:

$$| \text{Level A} - \text{Level B} | \geq 16 \text{ then average } Tr \leq 8\text{ms} \ \& \ \text{average } Tf \leq 8\text{ms}$$

Note 3: Brightness uniformity of these 9 points is defined as below

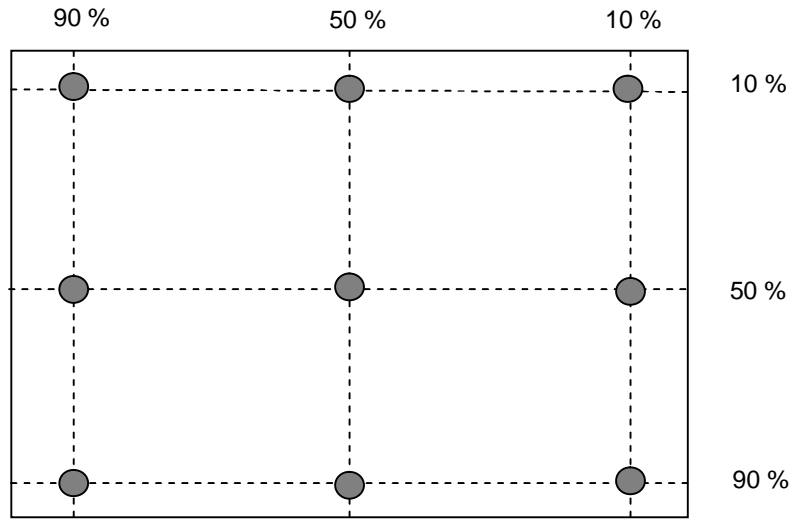

$$\text{Uniformity} = \frac{\text{Minimum Luminance in 9 points (1-9)}}{\text{Maximum Luminance in 9 Points (1-9)}} \times 100\%$$

Note 4: Crosstalk is defined as below :

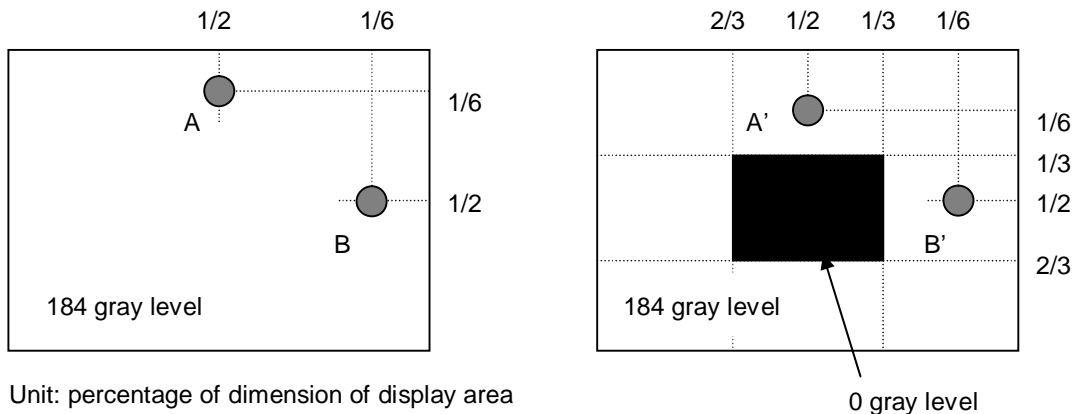

Unit: percentage of dimension of display area

$|L_A - L_{A'}| / L_A \times 100\% = 1.5\% \text{ max.}$, L_A and L_B are brightness at location A and B

$|L_B - L_{B'}| / L_B \times 100\% = 1.5\% \text{ max.}$, $L_{A'}$ and $L_{B'}$ are brightness at location A' and B'

Note5: Test Patern: Subchecker Pattern

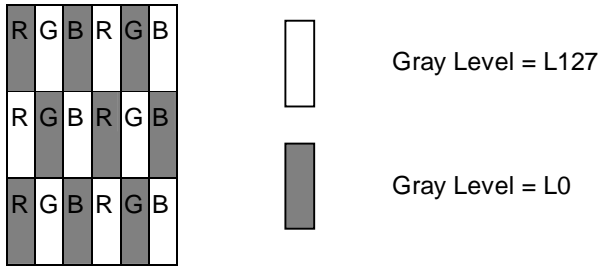

Method: Record dBV & DC value with (WESTAR)TRD-100

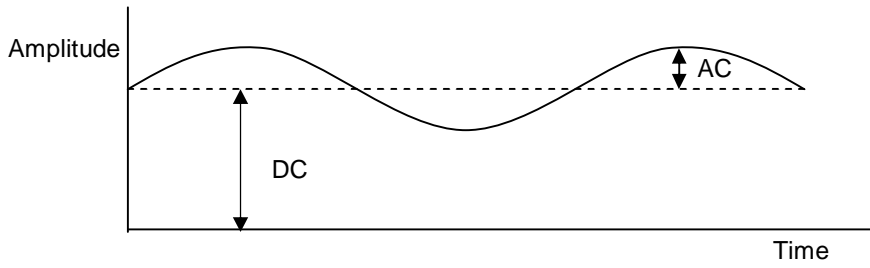

$$\text{Flicker (dB)} = 20 \log \frac{\text{AC Level(at 30 Hz)}}{\text{DC Level}}$$

3.0 Functional Block Diagram

The following diagram shows the functional block of the 20.1 inches wide Color TFT/LCD Module:

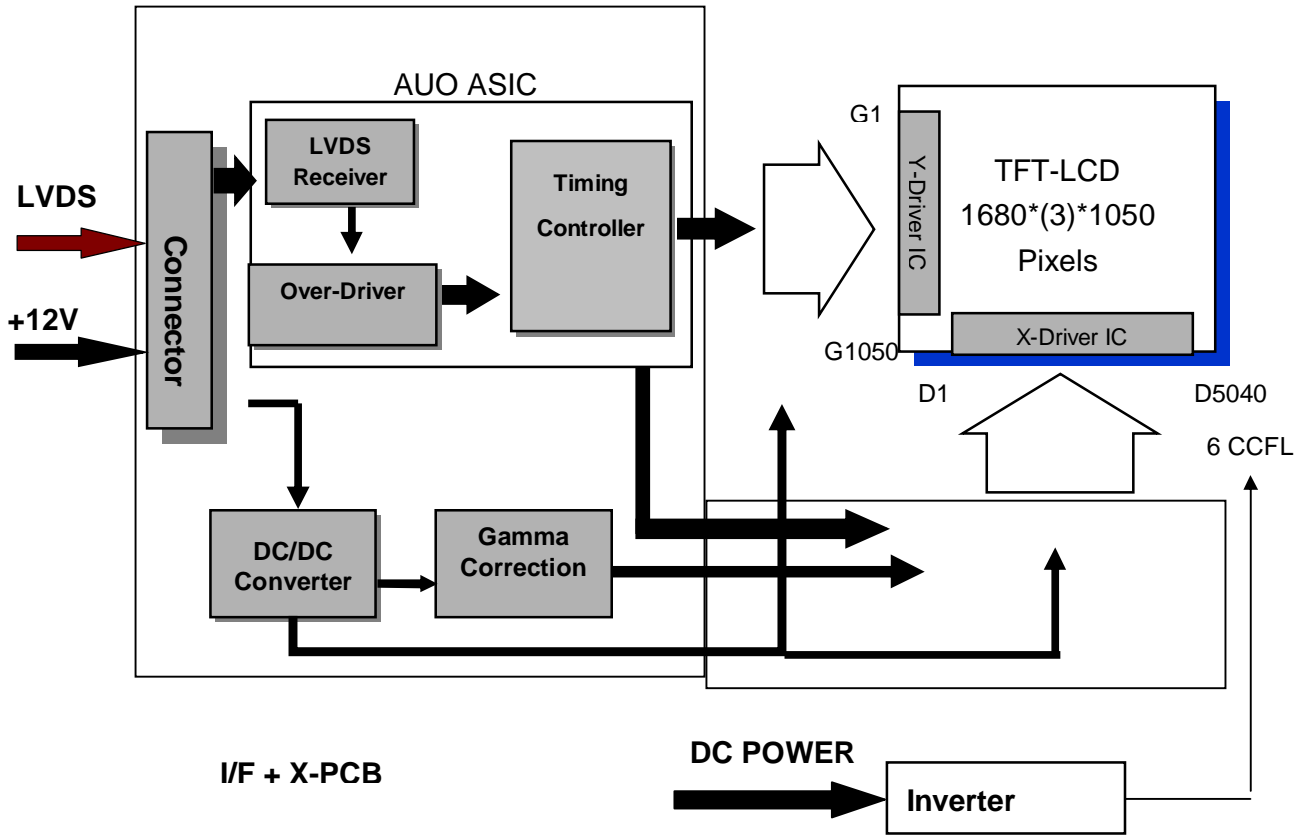

JAE: FI-XB30SSL-HF15

JST: BHSR-02VS-1 (2 pin)
BHSR-05VS-1 (5 pin)

Mating Type:
JAE: FI-X30S-H

Mating Type:
SM02B-BHSS-1-TB (2 pin)
SM04(9-E2)B-BHS-1-TB (5 pin)

4.0 Absolute Maximum Ratings

Absolute maximum ratings of the module is as following:

4.1 TFT LCD Module

Item	Symbol	Min	Max	Unit	Conditions
Logic/LCD Drive	VIN	-0.3	14	[Volt]	Note 1,2

4.2 Backlight Unit

Item	Symbol	Min	Max	Unit	Conditions
CCFL Current	ICFL	-	8	[mA] rms	Note 1,2

4.3 Absolute Ratings of Environment

Item	Symbol	Min	Max	Unit	Conditions
Operating Humidity	HOP	5	90	[%RH]	Note
Storage Temperature	TST	-20	+60	[°C]	Note
Storage Humidity	HST	5	90	[%RH]	Note

Note 1: With in Ta (25°C)

Note 2: Permanent damage to the device may occur if exceed maximum values

Relative Humidity %

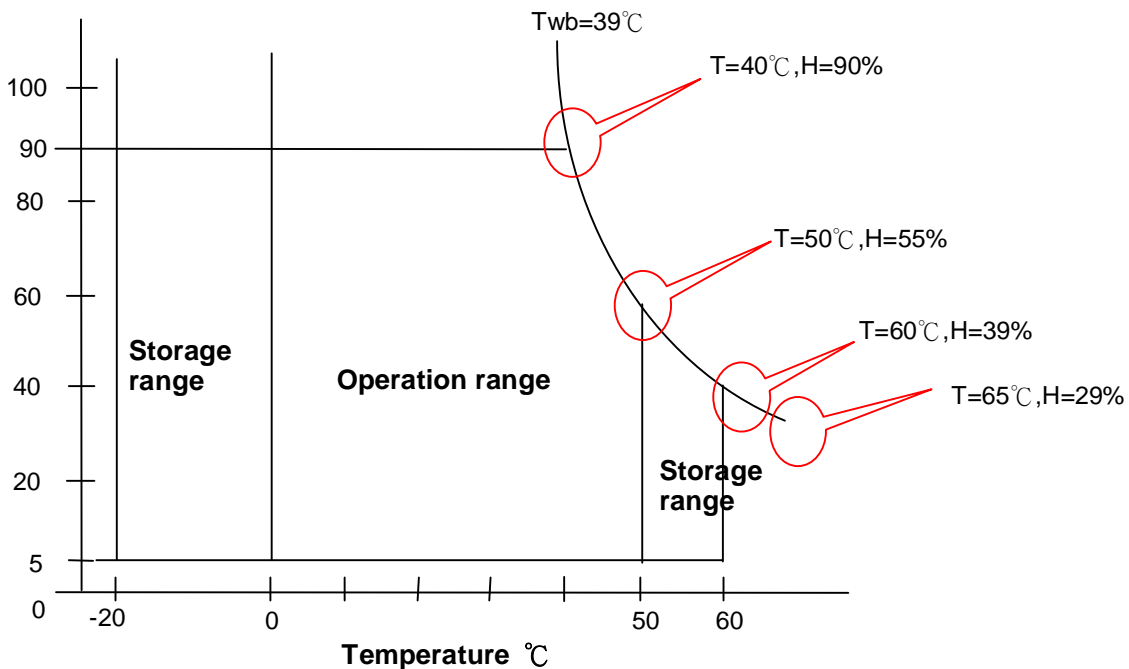

5.0 Electrical characteristics

5.1 TFT LCD Module

5.1.1 Power Specification

Input power specifications are as follows;

(C) Copyright AU Optronics
 2005 All Rights Reserved.
 No Reproduction and Redistribution Allowed.

Symbol	Parameter	Min	Typ	Max	Units	Condition
VDD	Logic/LCD Drive Voltage	10.8	12	13.2	[Volt]	± 10%
IDD	VDD current	-	550	650	[mA]	Vin=12V , All White Pattern, at 60Hz
Irush	LCD Inrush Current	-	-	2.5	[A]	Note
PDD	VDD Power	-	6.6	8	[Watt]	Vin=12V , All White Pattern, at 60Hz
VDDrp	Allowable Logic/LCD Drive Ripple Voltage			100	[mV] p-p	

Note: Measurement conditions:

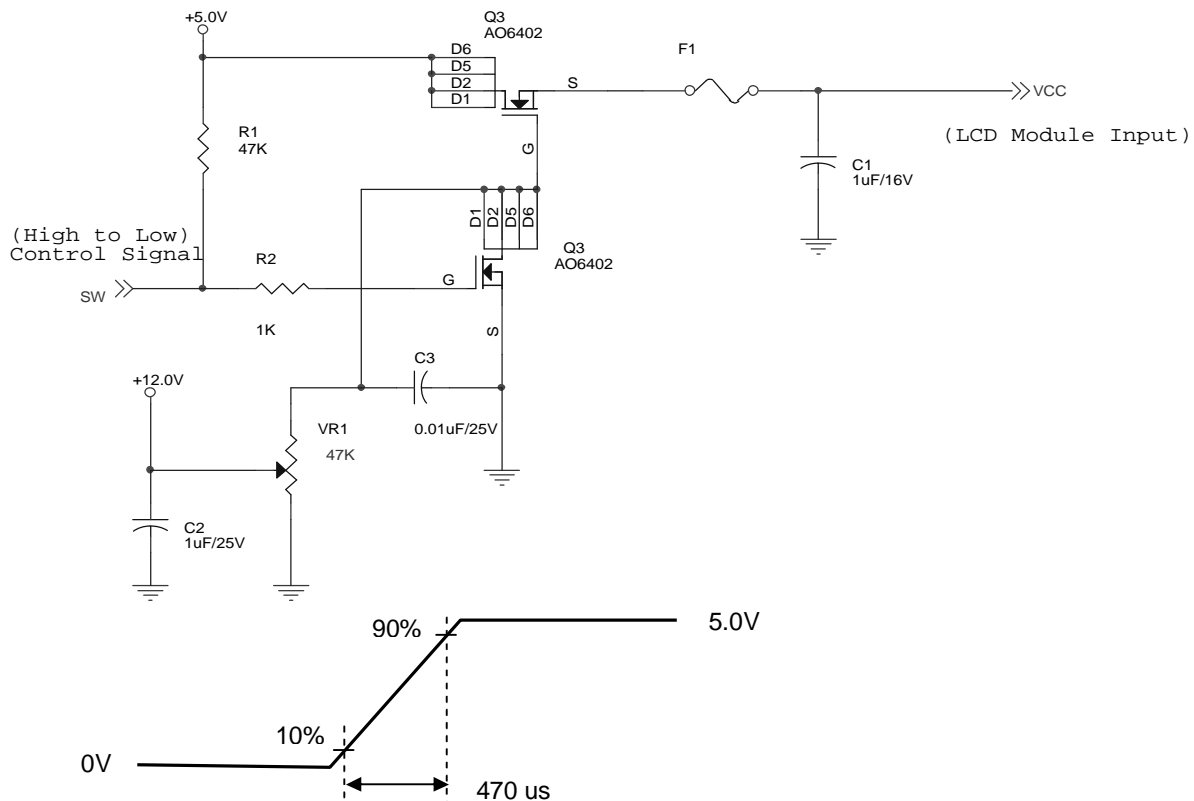

Vin rising time

5.1.2 Signal Electrical Characteristics

Input signals shall be low or Hi-Z state when Vin is off

It is recommended to refer the specifications of SN75LVDS82DGG (Texas Instruments) in detail.

Each signal characteristics are as follows;

Symbol	Parameter	Min	Typ	Max	Units	Condition
--------	-----------	-----	-----	-----	-------	-----------

VTH	Differential Input High Threshold	-	-	+100	[mV]	VICM = 1.2V Note
VTL	Differential Input Low Threshold	-100	-	-	[mV]	VICM = 1.2V Note
VID	Input Differential Voltage	100	400	600	[mV]	Note
VICM	Differential Input Common Mode Voltage	+1.0	+1.2	+1.5	[V]	VTH/VTL = ±100mV Note

Note: LVDS Signal Waveform

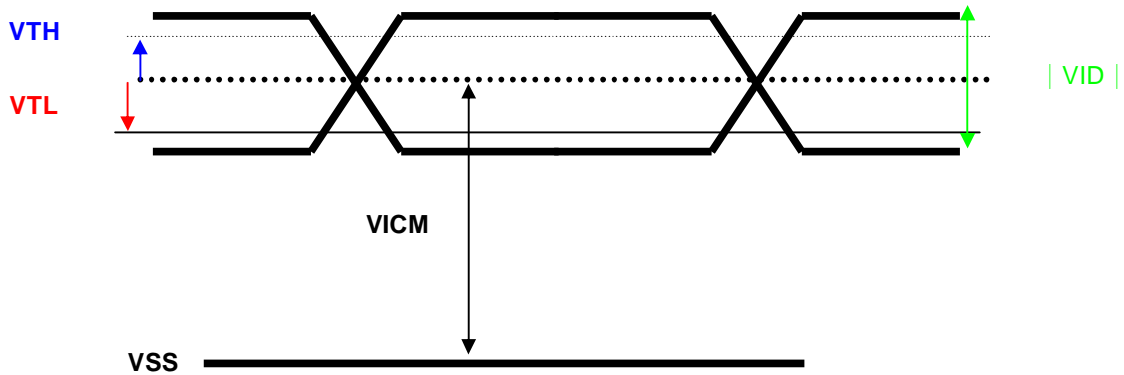

5.2 Backlight Unit

Parameter guideline for CCFL Inverter

Symbol	Parameter	Min.	Typ.	Max.	Unit	Condition
ISCFL	CCFL standard current	6.5	7.0	7.5	[mA] rms	(Ta=25°C) Note 1

IRCFL	CCFL operation range	3.0	7.0	8.0	[mA] rms	(Ta=25°C)
FCFL	CCFL Frequency	40	55	80	[KHz]	(Ta=25°C) Note 2
ViCFL (0°C)	CCFL Ignition Voltage (End of the lamp wire connector)	2120	-		[Volt] rms	(Ta=0°C) Note 3
ViCF (25°C)	CCFL Ignition Voltage (End of the lamp wire connector)	1625	-		[Volt] rms	(Ta=25°C) Note 3
VCFL	CCFL Operation Voltage	750 @8mA	783 @7mA	936 @3mA	[Volt] rms	(Ta=25°C) Note 4
PCFL	CCFL Power consumption (for reference)	-	32.9	-	[Watt]	(Ta=25°C) Note 5
LTCFL	CCFL life Time	40,000	50,000	-	[Hour]	(Ta=25°C) Note 6

Note 1: CCFL standard current is measured at 25±2°C.

Note 2: CCFL Frequency should be carefully determined to avoid interference between inverter and TFT LCD

Note 3: ViCFL means Ignition Voltage for both ends of the lamp, and CCFL inverter should be able to give out a power that has a generating capacity of over ViCFL for ignition

Note 4: CCFL operation voltage is measured at 25±2°C.

Note 5: The variance of CCFL power consumption is ±10%. Power is calculated for reference (ICFL×VCFL×6=PCFL).

Note 6: Definition of life: brightness becomes 50% or less than the minimum luminance value of CCFL..The typical life time of CCFL is on the condition at 6.0 mA lamp current.

6.0 Signal Characteristic

6.1 Pixel Format Image

Following figure shows the relationship of the input signals and LCD pixel format.

	1			2												1679			1680		
1st Line	R	G	B	R	G	B										R	G	B	R	G	B

1050 Line	R	G	B	R	G	B										R	G	B	R	G	B

6.2 The input data format

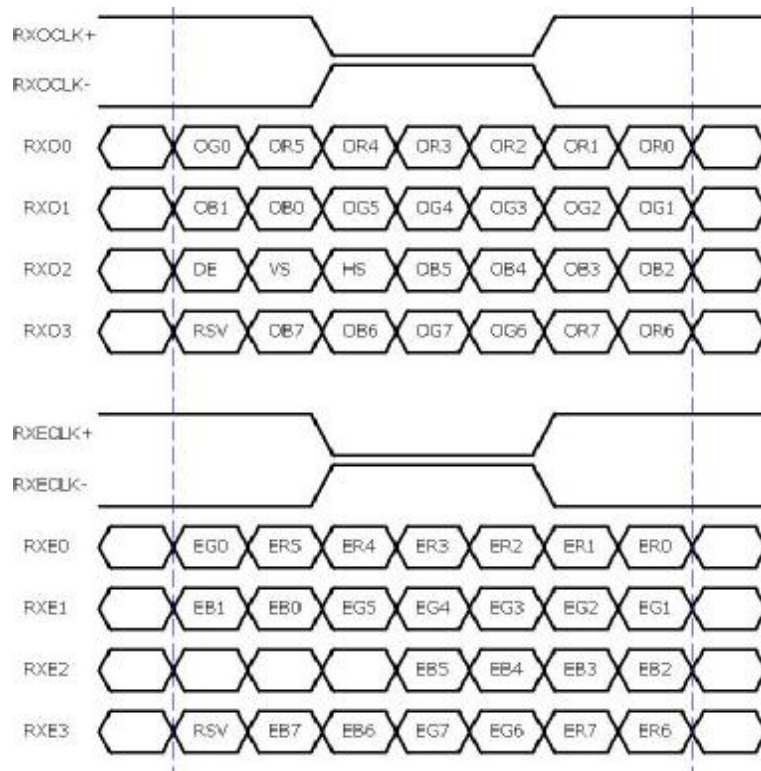

Note 1: R/G/B data 7:MSB, R/G/B data 0:LSB
 O = "First Pixel Data"
 E = "Second Pixel Data"

6.3 Signal Description

The module using one LVDS receiver SN75LVDS82(Texas Instruments) or compatible. LVDS is a differential signal technology for LCD interface and high speed data transfer device. Transmitter shall be

SN75LVDS83(negative edge sampling) or compatible . The first LVDS port(RxOxxx) transmits odd pixels while the second LVDS port(RxExxx) transmits even pixels.

PIN #	SIGNAL NAME	DESCRIPTION
1	RxO0-	Negative LVDS differential data input (Odd data)
2	RxO0+	Positive LVDS differential data input (Odd data)
3	RxO1-	Negative LVDS differential data input (Odd data)
4	RxO1+	Positive LVDS differential data input (Odd data)
5	RxO2-	Negative LVDS differential data input (Odd data, H-Sync,V-Sync,DSPTMG)
6	RxO2+	Positive LVDS differential data input (Odd data, H-Sync,V-Sync,DSPTMG)
7	GND	Power Ground
8	RxOC-	Negative LVDS differential clock input (Odd clock)
9	RxOC+	Positive LVDS differential clock input (Odd clock)
10	RxO3-	Negative LVDS differential data input (Odd data)
11	RxO3+	Positive LVDS differential data input (Odd data)
12	RxE0-	Negative LVDS differential data input (Even clock)
13	RxE0+	Positive LVDS differential data input (Even data)
14	GND	Power Ground
15	RxE1-	Positive LVDS differential data input (Even data)
16	RxE1+	Negative LVDS differential data input (Even data)
17	GND	Power Ground
18	RxE2-	Negative LVDS differential data input (Even data)
19	RxE2+	Positive LVDS differential data input (Even data)
20	RxEC-	Negative LVDS differential clock input (Even clock)
21	RxEC+	Positive LVDS differential clock input (Even clock)
22	RxE3-	Negative LVDS differential data input (Even data)
23	RxE3+	Positive LVDS differential data input (Even data)
24	GND	Power Ground
25	NC	No contact (For AUO test only)
26	NC	No contact (For AUO test only)
27	NC	No contact (For AUO test only)
28	POWER	Power
29	POWER	Power
30	POWER	Power

Note1: Start from left side

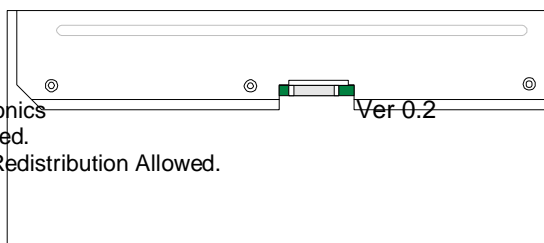

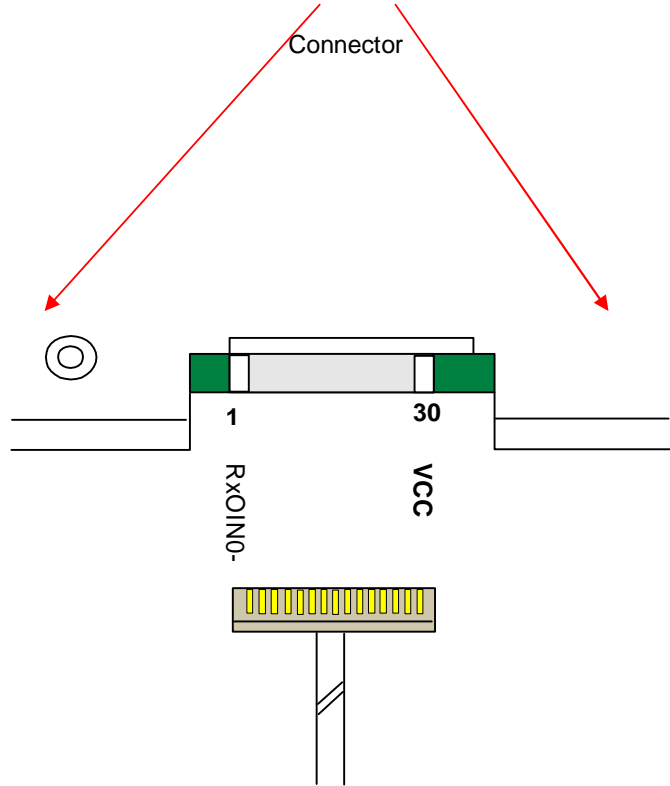

Note2: Input signals of odd and even clock shall be the same timing.

6.4 Timing Characteristics

Basically, interface timings described here is not actual input timing of LCD module but output timing of SN75LVDS82DGG (Texas Instruments) or equivalent.

Signal	Item	Symbol	Min	Typ	Max	Unit
Vertical Section	Period	T_v	1061	1087	1600	Th
	Active	$T_{disp(v)}$	1050	1050	1050	Th
	Blanking	$T_{bp(v)}+T_{fp(v)}+PW_{vs}$	11	37	550	Th
Horizontal Section	Period	T_h	920	1128	1400	Tclk
	Active	$T_{disp(h)}$	840	840	840	Tclk
	Blanking	$T_{bp(h)}+T_{fp(h)}+PW_{hs}$	80	288	560	Tclk
Clock	Period	T_{clk}	12.3	13.6	16.67	ns
	Frequency	Freq	60	73.5	81	MHz
Frame rate	Frame rate	F	55	60	75	Hz

Note : DE mode only

6.4.1 Timing diagram

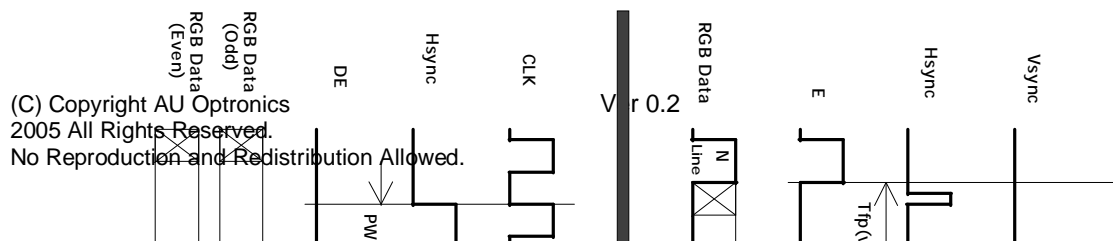

(C) Copyright AU Optonics
2005 All Rights Reserved.
No Reproduction and Redistribution Allowed.

6.5 Power ON/OFF Sequence

Vin power and lamp on/off sequence is as follows. Interface signals are also shown in the chart. Signals from any system shall be Hi-Z state or low level when Vin is off.

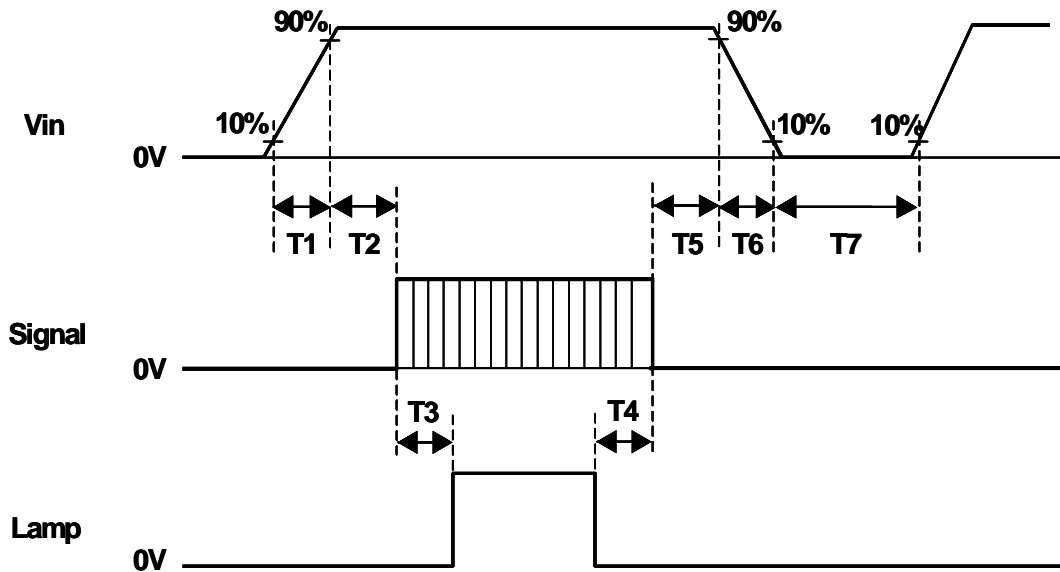

Symbol	Values			Unit
	Min	Typ	Max	
T1	0.5	-	10	[ms]
T2	0.5	40	50	[ms]
T3	200	-	-	[ms]
T4	200	-	-	[ms]
T5	0.5	16	50	[ms]
T6	-	-	10	[ms]
T7	1000	-	-	[ms]

7.0 Connector & Pin Assignment

Physical interface is described as for the connector on module.

These connectors are capable of accommodating the following signals and will be following components.

7.1 TFT LCD Module

Connector Name / Designation	Interface Connector / Interface card
Manufacturer	JAE or compatible
Type Part Number	FI-XB30SSL-HF15
Mating Housing Part Number	JAE: FI-X30S-H

Pin#	Signal Name	Pin#	Signal Name
1	RxO0-	2	RxO0+
3	RxO1-	4	RxO1+
5	RxO2-	6	RxO2+
7	GND	8	RxOC-
9	RxOC+	10	RxO3-
11	RxO3+	12	RxE0-
13	RxE0+	14	GND
15	RxE1-	16	RxE1+
17	GND	18	RxE2-
19	RxE2+	20	RxEC-
21	RxEC+	22	RxE3-
23	RxE3+	24	GND
25	NC	26	NC
27	NC	28	Power
29	Power	30	Power

7.2 Backlight Unit

Connector Name / Designation	Lamp Connector / Backlight lamp
-------------------------------------	---------------------------------

Manufacturer	JST
Type Part Number	BHSR-02VS-1 (CN3/CN4) BHSR-05VS-1 (CN2/CN5)
Mating Type Part Number	SM02B-BHSS-1-TB (2pin) SM04 (9-E2) B-BHS-1-TB (5pin)

7.3 Signal for Lamp connector

	Connector No.	Pin No.	Color	Function
Upper	CN2	1	Pink	High Voltage (Lamp 1)
		2	Sky Blue	High Voltage (Lamp 2)
		3	NC	NC
		4	Black	Low Voltage (Lamp 1)
		5	Dark Blue	Low Voltage (Lamp 2)
	CN3	1	White	High Voltage (Lamp 3)
		2	White	Low Voltage (Lamp 3)
Lower	CN4	1	White	High Voltage (Lamp 4)
		2	White	Low Voltage (Lamp 4)
	CN5	1	Pink	High Voltage (Lamp 6)
		2	Sky Blue	High Voltage (Lamp 5)
		3	NC	NC
		4	Black	Low Voltage (Lamp 6)
		5	Dark Blue	Low Voltage (Lamp 5)

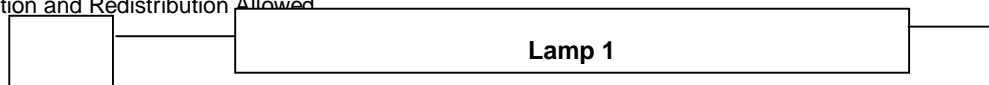

8.0 Reliability

Reliability test condition

No	<i>Test Item</i>	<i>Test Condition</i>
-----------	-------------------------	------------------------------

1	Temperature Humidity Bias (THB)	50°C, 80%, 300hours
2	High Temperature Operation (HTO)	50°C, 300hours
3	Low Temperature Operation (LTO)	0°C, 300hours
4	High Temperature Storage (HTS)	60°C, 300hours
5	Low Temperature Storage (LTS)	-20°C, 300hours
6	Thermal Shock Test (TST)	-20°C/30min, 60°C/30min, 100 cycles
7	On/Off Test	On/10sec, Off/10sec, 30,000 cycles
8	Shock Test (Non-Operating)	50G, 20ms, Half-sine wave ($\pm X$, $\pm Y$, $\pm Z$)
9	Vibration Test (Non-Operating)	1.5G(10~200Hz P- P), 30 Minutes each Axis (X, Y, Z)
10	Drop test	Package test: The drop height is 60cm.
11	ESD (ElectroStatic Discharge)	Contact Discharge: $\pm 8KV$, 150pF(330 Ω) 1sec, 8 points, 25 times/ point Air Discharge: $\pm 15KV$, 150pF(330 Ω) 1sec, 8 points, 25 times/ point
12	Altitude Test	Operation:10,000 ft Non-Operation:30,000 ft

9.0 Environment

The display module will meet the provision of this specification during operating condition or after storage

or shipment condition specified below. Operation at 10% beyond the specified range will not cause physical damage to the unit.

9.1 Temperature and Humidity

9.1.1 Operating Conditions

The display module operates error free, when operated under the following conditions;

Temperature	0 °C to 50 °C
Relative Humidity	5% to 90%
Wet Bulb Temperature	39.0 °C

9.1.2 Shipping Conditions

The display module operates error free, after the following conditions;

Temperature	-20 °C to 60 °C
Relative Humidity	5% to 90%
Wet Bulb Temperature	39.0 °C

9.2 Atmospheric Pressure

The display assembly is capable of being operated without affecting its operations over the pressure range as following specified;

	Pressure	Note
Maximum Pressure	1040hPa	0m = sea level
Minimum Pressure	674hPa	3048m = 10.000 feet

Note : Non-operation attitude limit of this display module = 30,000 feet. = 9145 m.

10.0 Safety

10.1 Sharp Edge Requirements

There will be no sharp edges or comers on the display assembly that could cause injury.

10.2 Materials

10.2.1 Toxicity

There will be no carcinogenic materials used anywhere in the display module. If toxic materials are used, they will be reviewed and approved by the responsible ADT Toxicologist.

10.2.2 Flammability

All components including electrical components that do not meet the flammability grade UL94-V1 in the module will complete the flammability rating exception approval process.

The printed circuit board will be made from material rated 94-V1 or better. The actual UL flammability rating will be printed on the printed circuit board.

10.3 Capacitors

If any polarized capacitors are used in the display assembly, provisions will be made to keep them from being inserted backwards.

11.0 Other requirement

11.1 National Test Lab Requirement

The display module will satisfy all requirements for compliance to

UL 1950, First Edition
 CSA C22.2 No.950-M89
 EEC 950
 EN 60 950

U.S.A. Information Technology Equipment
 Canada, Information Technology Equipment
 International, Information Technology Equipment
 International, Information Processing Equipment
 (European Norm for IEC950)

11.2 Label

The label is on the panel as shown below:



