



Highlights

- *Constant Force (CF) patented lift-and-pivot motion technology produces smooth adjustment* 
- *Position your LCD or TV for maximum comfort and productivity*
- *Weight capacity adjusts to hold 5–20 lbs (2.3–9.1 kg)*
- *13" (330 mm) vertical range ergonomically meets the eye height of more than nine out of ten adults*
- *Allows monitor to be rotated for portrait/landscape viewing*
- *Upgrade LCDs with improved ergonomic adjustability*
- *Internal cable management routes cables neatly under arm*
- *Easily attaches to LCDs that are VESA® MIS-D, 100/75, C compliant*
- *2007 Adex Award, gold* 

Ergotron® LX

Desk and Wall Mount LCD Arms



More motion. Less effort. Feel the difference.

Ergotron's LX LCD Arms include Constant Force (CF) patented lift-and-pivot motion technology. With a light touch of your hand you can easily lift, swing, tilt or turn your display.

- Increase viewing comfort—help reduce eye, back and neck strain
- Reposition your display with just a touch
- Excellent price performance
- Arm extends LCD up to 24" and 33" when a second extension is used—push it back out of the way
- Wall Mount or Desk Mount installation

The LX LCD Arm is the perfect desk or wall mount accessory to add flexibility and superior ergonomics to your LCD monitor or TV. Sleek and streamlined, it frees up space and allows you to easily position your display for greater productivity. It's ideal for home and office use, especially in situations where several people use the same display.



Patented CF lift-and-pivot motion technology is utilized in display pivot and body of arm.

The LX LCD Arm is compatible with displays that are VESA MIS-D compliant. Simply remove existing base of the display, match up hole pattern (75 or 100 mm) and attach display to the LX with four screws.

Screen height, viewing angle and viewing distance are all easily adjusted for each user.

Cables are guided along underside of arm for a clutter-free work area.

Desk clamp base uses little space yet ensures stability even as display is adjusted. Attach Arm at any height on pole. (LX Arm shown in black.)

Adjustment range of the LX Arm allows LCD to be lowered into a position that is comfortable for people wearing bifocals or using a tablet PC (at left, LX Arm mounted on Ergotron Wall Track).

LX LCD Arm can be used without its extension or with a second 9-inch extension.



Range of Motion

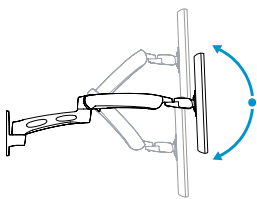

13" (330 mm) height range

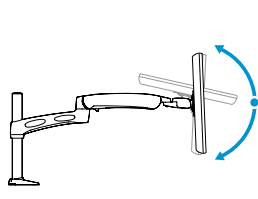

LCD tilts +5/-75° forward/back

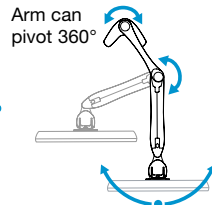

Arm can pivot 360°
LCD pans 180° right/left

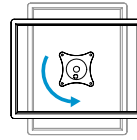

LCD rotates 90° portrait/landscape

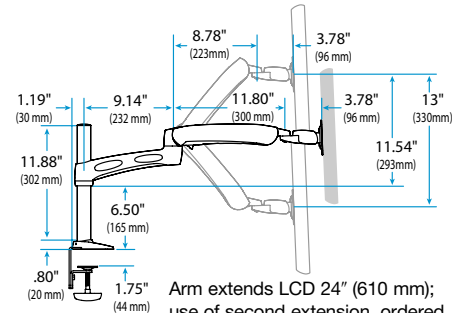

Arm extends LCD 24" (610 mm); use of second extension, ordered separately, extends Arm 33" (838 mm)

Basic Specifications

Descriptions:

- LX Desk Mount LCD Arm
Commercial Part Number: 45-179-194 (silver)
45-179-195 (black)
- LX Wall Mount LCD Arm
Commercial Part Number: 45-180-194 (silver)
45-180-195 (black)
- LX Extension
Commercial Part Number: 45-189-194 (silver)
45-189-195 (black)

Weight Capacity: 5–20* lbs (2.3–9.1 kg)

* System weight capacity is reduced by using two extensions. See installation manual or ergotron.com for details.

Shipping Weight: 11 lbs (5 kg)

Warranty: 5 year

Attachment Options:

- Desk Mount (clamp and grommet bases included): clamp to surfaces 1/2–1-7/8" (12.7–47.6 mm) thick or grommet mount through holes 5/16–2" (7.9–51 mm) wide and up to 2-1/2" (63.5 mm) thick.
- Wall Mount: attach directly to sturdy vertical surface. Wall track or wall plate recommended (order separately).

Display Interface Options:

- VESA FDMI MIS-D, 100/75, C (hole pattern: 100 x 100 mm & 75 x 75 mm)

© 2009 Ergotron, Inc. rev. 08/05/2009 870-05-056 Content is subject to change without notification.

Americas Sales and Corporate Headquarters

St. Paul, MN USA
(800) 888-8458
+1-651-681-7600
www.ergotron.com
sales@ergotron.com

EMEA Sales

Amersfoort, The Netherlands
+31 33 45 45 600
www.ergotron.com
info.eu@ergotron.com

APAC Sales

Singapore
www.ergotron.com
info.apac@ergotron.com

Worldwide OEM Sales

www.ergotron.com
info.oem@ergotron.com

