

FloorSource Raised Floor Boxes

The Walker FloorSource Series offers the largest selection of raised floor boxes in the industry. The FloorSource Raised Floor Boxes are the pinnacle of functionality, flexibility, accessibility, and capacity when it comes to raised floor box applications. They have many applications, some of which are PBX rooms, MIS processing rooms, IRS regional processing centers, university computer labs, and financial institutions. Walker provides three unique styles of boxes which allow the user a variety of combinations for power and communication. Best of all, FloorSource Raised Floor Boxes are compatible with the Walkerflex® Manufactured Wiring System.

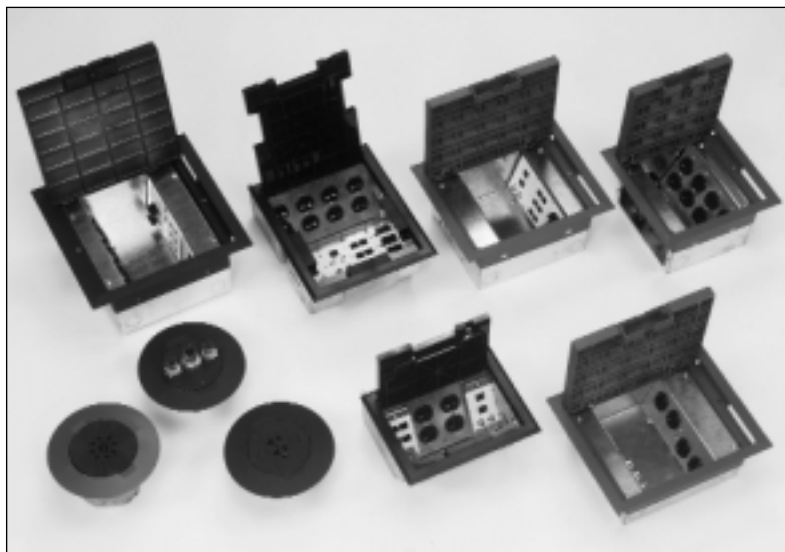

Walker FloorSource Series offer flexibility, accessibility, and capacity.

Features & Benefits

- **Locking tabs help secure box to floor panel.** This allows for quick and easy installation.
- **Units can be prewired for power.** Prewired units reduce labor costs for field installation.
- **Large multi-compartment boxes.** Provides adequate wiring capacity and easily isolates power and communication services.
- **Boxes have several different depth profiles.** These profiles quickly and easily allow the end-user to meet different raised floor depth requirements.
- **Flexible box designs.** Allows the end-user to configure what services they want and need.
- **Activate™ UTP, coaxial, audio, video, and fiber optic inserts.** A wide variety of media interface inserts to insure a reliable, cost effective activation for today's most demanding communication system designs.
- **Meets UL Standard UL514A and Canadian Standard C22.2, No. 18-22, and bears the Listing Mark.**

AF Series Raised Floor Boxes

AF1*

The AF1 Raised Floor Box provides three separate compartments that accommodate a combination of both power and communication devices. This combination is accomplished due to the built-in service dividers. These dividers are arranged in a single-double, single-gang configuration. Polycarbonate hinged lid and trim flange are available for carpet or tile applications, as well as a color choice of black, brown, or gray.

**AF1 box available in a prewired (power) version. Consult your Wiremold sales representative for ordering information.*

Description	Dimension
Overall Trim Ring	8 3/4" x 6 3/4" [222mm x 171mm]
Module Depth Overall	5" [127mm]
Panel Opening	8" x 6" [203mm x 152mm]
Cover Size	7 1/2" x 5" [191mm x 127mm]
Activation Chamber Volume	130 cu in. [2130 cu cm]
User Volume	78.6 cu in. [1288 cu cm]
Total Volume	208.6 cu in. [3418 cu cm]



Optional prewired version shown.

AF3*

The AF3 Raised Floor Box provides four separate compartments that accommodate up to eight communications or power devices. The top panel has a unique built-in service divider that accommodates a combination of power and communication. These dividers are arranged in a single-double, single-gang configuration. The lower panel provides single-gang activation points in a single service configuration. Polycarbonate hinged lid and trim flange are available for carpet or tile applications, as well as a color choice of black, brown, or gray.

**AF3 box available in a prewired (power) version. Consult your Wiremold sales representative for ordering information.*

Description	Dimension
Overall Trim Ring	8 3/4" x 10 3/4" [222mm x 273mm]
Module Depth Overall	5" [127mm]
Panel Opening	8" x 10" [203mm x 254mm]
Cover Size	7 1/2" x 9 1/2" [191mm x 242mm]
Activation Chamber Volume	220 cu in. [3604 cu cm]
User Volume	180 cu in. [2948 cu cm]
Total Volume	300 cu in. [4915 cu cm]

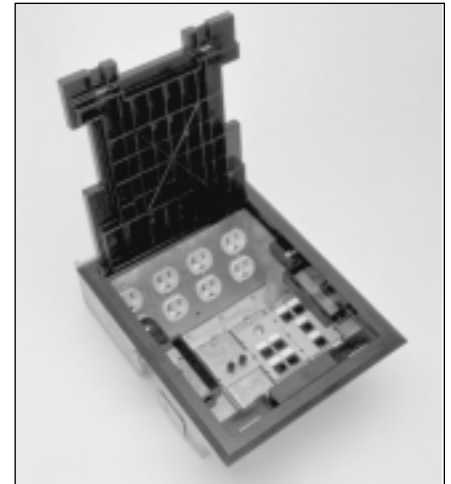

Optional prewired version shown.

Features & Benefits

- **Two locking tabs.** Provides secure access assembly to floor panel for ease of installation.
- **Die-cast aluminum bottom housing.** Provides added strength and reliability.
- **Units can be prewired for power.** Prewired units reduce labor costs for field installation.
- **Integral die-cast aluminum flange on bottom housing.** Provides added strength when mounted in raised floor panel.

Ordering Information for AF Series Floor Boxes

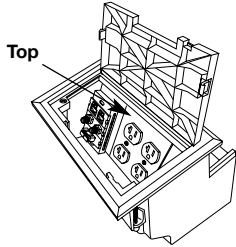
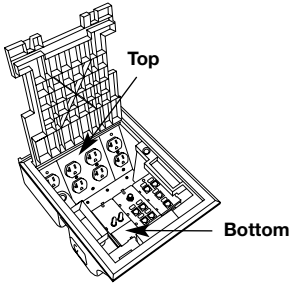
Catalog No./Item	Description/Specifications
AF1- KC AF1- KT AF1- NC AF1- NT AF1- YC AF1- YT	AF1 with Black Carpet Cover and Trim – 8" x 6" [203mm x 152mm]. AF1 with Black Tile Cover and Trim – 8" x 6" [203mm x 152mm]. AF1 with Brown Carpet Cover and Trim – 8" x 6" [203mm x 152mm]. AF1 with Brown Tile Cover and Trim – 8" x 6" [203mm x 152mm]. AF1 with Gray Carpet Cover and Trim – 8" x 6" [203mm x 152mm]. AF1 with Gray Tile Cover and Trim – 8" x 6" [203mm x 152mm].
 <p>Top</p>	
<p>AF2 (Optional Prewired Version of AF1)</p>	
AF3- KC AF3- KT AF3- NC AF3- NT AF3- YC AF3- YT	AF3 with Black Carpet Cover and Trim – 8" x 10" [203mm x 254mm]. AF3 with Black Tile Cover and Trim – 8" x 10" [203mm x 254mm]. AF3 with Brown Carpet Cover and Trim – 8" x 10" [203mm x 254mm]. AF3 with Brown Tile Cover and Trim – 8" x 10" [203mm x 254mm]. AF3 with Gray Carpet Cover and Trim – 8" x 10" [203mm x 254mm]. AF3 with Gray Tile Cover and Trim – 8" x 10" [203mm x 254mm].
 <p>Top</p> <p>Bottom</p>	
<p>AF4 (Optional Prewired Version of AF3)</p>	

NOTE: All boxes and plates are sold separately. AF1 and AF3 are boxes only. AF2 and AF4 are the prewired power versions of AF1 and AF3.

Upper (Top) Panel Device Plates for AF1 and AF3 Boxes

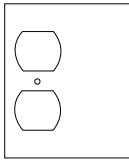
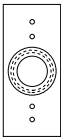
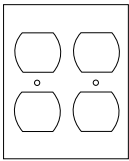
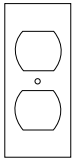
Catalog No./Item	Description/Specifications
SGT-DP SGT-B SGT-ACT	Single-Gang Plate – For duplex device. Single-Gang Plate – Blank. Single-Gang Plate – For Activate™ inserts. Accepts three 2A inserts (sold separately).
SGT-H* SGT-1KO DGT-2DP* DGT-DP/B* DGT-B* DGT-ACT*	Single-Gang Plate – For Heyco bushing/opening, single receptacle. Accepts three 2A inserts (sold separately). – 1" [25mm] KO. Double-Gang Plate – For two duplex devices. Double-Gang Plate – For one duplex device and blank. Double-Gang Plate – Blank. Double-Gang Plate – With one Activate™ bezel. Accepts three 2A inserts (sold separately).
 <p>SGT-B</p>  <p>DGT-DP/B</p>  <p>SGT-H</p>  <p>DGT-2DP</p>  <p>SGT-DP</p>	

*All DGT plates are for center top compartment only. Do not use single receptacles larger than 1 3/4" [44mm] diameter.

Lower (Bottom) Panel Device Plates for AF3 Boxes Only

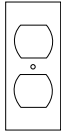
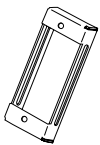
Catalog No./Item	Description/Specifications
SGB-DP SGB-B SGB-ACT	Single-Gang Plate – For duplex device. Single-Gang Plate – Blank. Single-Gang Plate – For Activate™ inserts. Accepts three 2A inserts (sold separately).
 <p>SGB-B</p>  <p>SGB-DP</p>  <p>SGB-ACT</p>	

NOTE: AF1 and AF3 Series boxes are available in an optional prewired configuration. All boxes and plates are sold separately. Lower panel accommodates four single-gang plates.

AC Series Raised Floor Boxes

AC8850 and AC8105

The AC8850 and AC8105 are boxes with a 5" [127mm] depth design, with the AC8105 providing an extra 2" [51mm] of width for additional wiring capacity. These boxes can accommodate four duplex power receptacles on one side. The communication plate will accept at least three communication bezels for up to 18 ports of activation.



Devices shown in photo are not supplied.

Description	AC8850 Dimension	AC8105 Dimension
Overall Trim Ring	9 1/4" x 9 1/4" [235mm x 235mm]	9 1/4" x 11 1/4" [235mm x 286mm]
Module Depth Overall	5" [127mm]	5" [127mm]
Panel Opening	8" x 8" [203mm x 203mm]	8" x 10" [203mm x 254mm]
Cover Size	7 11/16" x 7 11/16" [195mm x 195mm]	7 11/16" x 9 11/16" [195mm x 246mm]
Activation Chamber Volume	97.22 cu in. [1593 cu cm]	111.08 cu in. [1820 cu cm]
User Volume	102.22 cu in. [1674 cu cm]	151.97 cu in. [2490 cu cm]
Total Volume	199.22 cu in. [3264 cu cm]	262.97 cu in. [4309 cu cm]

AC8840 and AC8104

The AC8840 and AC8104 are boxes with a 4" [102mm] depth design, with the AC8104 providing an extra 2" [51mm] of width for added wiring capacity. These boxes can accommodate two duplex power receptacles on one side. The communication plate will accept two communication bezels for up to 12 ports of activation.

The AC Series offers greater capacity than any 4" [102mm] box on the market. All styles provide two, large-capacity compartments that can be divided when needed.



Devices shown in photo are not supplied.

Description	AC8840 Dimension	AC8104 Dimension
Overall Trim Ring	9 1/4" x 9 1/4" [235mm x 235mm]	9 1/4" x 11 1/4" [235mm x 286mm]
Module Depth Overall	4" [102mm]	4" [102mm]
Panel Opening	8" x 8" [203mm x 203mm]	8" x 10" [203mm x 254mm]
Cover Size	7 11/16" x 7 11/16" [195mm x 195mm]	7 11/16" x 9 11/16" [195mm x 246mm]
Activation Chamber Volume	63.92 cu in. [1047 cu cm]	76.87 cu in. [1260 cu cm]
User Volume	84.34 cu in. [1382 cu cm]	130.09 cu in. [2131 cu cm]
Total Volume	152.34 cu in. [2496 cu cm]	201.09 cu in. [3295 cu cm]

Features & Benefits

- **Locking toggle.** Secures access assembly to floor panel for ease of installation.

■ **Cable guard.** Shields wires from mechanical damage
- due to kicks and knocks.

■ **Reversible cover.** May be rotated 180° for changes in workstation locations.

AC Series Raised Floor Boxes (Continued)

AC10105

The AC10105 box with a 5" [127mm] depth is a square profile box that provides a full eight-gangs of power and/or communication device capacity. The AC10105 also provides increased plug-in volume which is ideal for the additional space needed when plugging in transformer type plugs.

Description	Dimension
Overall Trim Ring	11 1/2" x 11 1/2" [292mm x 292mm]
Module Depth Overall	5" [127mm]
Panel Opening	10" x 10" [254mm x 254mm]
Cover Size	9 5/8" x 9 5/8" [245mm x 245mm]
Activation Chamber Volume	115 cu in. [1884 cu cm]
User Volume	243 cu in. [3981 cu cm]
Total Volume	358 cu in. [5865 cu cm]

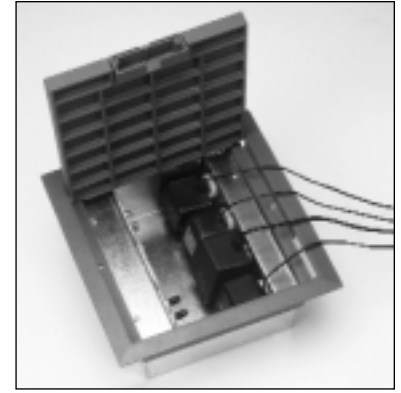

Devices shown in photo are not supplied.

Ordering Information for AC Series (Box Only) Raised Floor Boxes

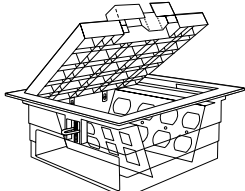
Catalog No./Item	Description/Specifications
<p>AC8840 AC8850 AC8104 AC8105 AC10105</p> 	<p>8" x 8" x 4" Box – [203mm x 203mm x 102mm]. 8" x 8" x 5" Box – [203mm x 203mm x 127mm]. 8" x 10" x 4" Box – [203mm x 254mm x 102mm]. 8" x 10" x 5" Box – [203mm x 254mm x 127mm]. 10" x 10" x 5" Box – [254mm x 254mm x 127mm].</p>

NOTE: All 4" [102mm] deep boxes supplied with two-power duplex receptacle knockout plate. All 5" [127mm] deep boxes supplied with four-power duplex receptacle knockout plate.

Ordering Information for AC Series (Power Plates Only) Raised Floor Boxes

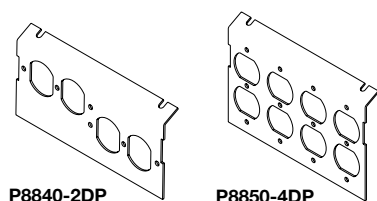
Catalog No./Item	Description/Specifications
<p>P8840-2DP P8850-4DP P8104-2DP P8105-4DP P10105-4DP</p> 	<p>AC8840 Power Plate – Two duplex KOs. AC8850 Power Plate – Four duplex KOs. AC8104 Power Plate – Two duplex KOs. AC8105 Power Plate – Four duplex KOs. AC10105 Power Plate – Four duplex KOs.</p>

Ordering Information for AC Series (Communication Plates Only) Raised Floor Boxes

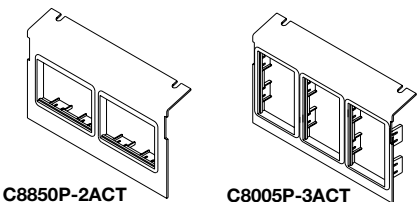
Catalog No./Item	Description/Specifications
<p>C8004P-2DBP C8004P-2ACT C8850P-ACT C8850P-2ACT C8005P-3ACT C8005P-3DBP C10105P-B C10105P-4DP C10105P-3ACT</p> 	<p>AC8840 & AC8104 Plate – Two duplex KOs. AC8840 & AC8104 Plate – With two Activate 6A bezels. AC8850 Plate – With one Activate 6A bezel. AC8850 Plate – With two Activate 6A bezels. AC8850 & AC8105 Plate – With three Activate 6A bezels. AC8850 & AC8105 Plate – Three duplex KOs. AC10105 Plate – Blank. AC10105 Plate – Four duplex KOs. AC10105 Plate – Three Activate 6A bezels.</p>

NOTE: All communication plates sold separately.

Interlink Activate™ Connectivity System for the FloorSource Series

- Wide variety of inserts for voice, data, audio, and video.
- Category 5e inserts and keystone jacks exceed ANSI/TIA/EIA568-A-5 Category 5e component performance requirements and utilize universal wiring for both T568A/B.
- Combine up to three 2A inserts within the 6A single-gang opening for true multi-media capabilities.
- Inserts feature a front loading snap-in design for ease of installation, addition, and configuration changes.
- Port labeling can be provided through use of optional icon buttons, labels, and label templates which can be downloaded from www.wiremold.com.
- For use with FloorSource, the Activate inserts snap directly into mini adapter bezels in the AC Series or Activate mounting brackets in the AF Series. Depending on the depth of the box selected, you get three, six, or nine inserts per Activate plate, allowing total flexibility for your data and communication requirements.

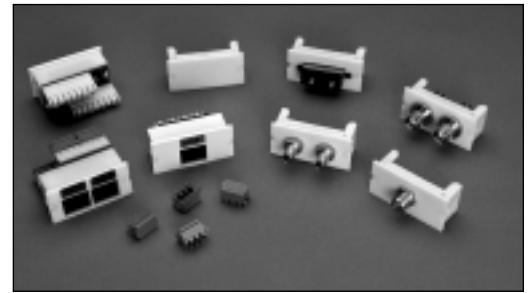

Common Workstation Inserts

Insert With:	2A Size	
	Single Port	Dual Port
1 or 2 RJ45, T568A/B, Category 5e Jacks	2A145-C5E	2A245-C5E
1 or 2 RJ12, 6W, USOC Category 3 Jacks	2A112-U	2A212-U
1 Duplex SC Connector	—	2A-2SC
Dual ST Multi-Mode Connector	—	2A-2ST-MM
1 or 2 RCA Audio Connectors	2A-1RCA	2A-2RCA
1 or 2 BNC Connectors	2A-1BNC	2A-2BNC
1 or 2 Video "F" Connectors	2A-1F	2A-2F
1 BNC and 1 Video "F" Connector	—	2A-BNC-F
Keystone/Open System Insert (Unloaded)	2A-U1KEY*	2A-U2KEY*
Blank Insert	2A-BL	—
3-Way Binding Post Audio Connector	—	2A-2RBBP
1 Super VHS Connector	2A-1SVHS	—

NOTE: Standard color for Activate Inserts is Ivory, for other colors add one of the following: -WH White, -BK Black, -GY Gray (matches aluminum and nonmetallic products), -G Gray (matches gray steel raceways).

*See chart for discrete keystone jacks.

Discrete Keystone Jacks

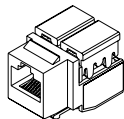
	Wiring Type	Catalog Number
	Category 5e, RJ45, T568A/B	AC-C5EKEY

NOTE: Standard color is Ivory, for other colors add one of the following: -WH White, -BK Black, -GY Gray (matches aluminum and nonmetallic products), -RD Red, -BL Blue, -GR Green, -YL Yellow, -OR Orange.

Labeling Options *

Assorted Icon Labels – 30 Labels (5 Sheets)	IL-30-A-XX
Voice Icon Labels – 30 Labels (5 Sheets)	IL-30-V-XX
Data Icon Labels – 30 Labels (5 Sheets)	IL-30-D-XX
Voice Icon Buttons (100/Package)	DI-02V-XX
Data Icon Buttons (100/Package)	DI-02D-XX

*Replace XX in part number with one of the following to identify color: -BL Blue, -GR Green, -GY Gray, -OR Orange, -RD Red, -VL Violet, -WH White, -YL Yellow.

Mounting Plates and Bezels for FloorSource

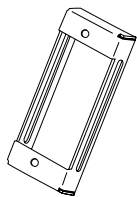
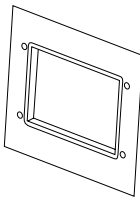
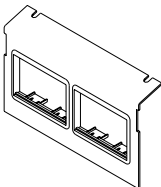
AF SERIES		AC SERIES
<p>SGT-ACT or SGB-ACT</p>  <p>Single-Gang Activate Bracket for installing Activate Inserts into AF boxes (6A openings).</p>	<p>DGT-ACT</p>  <p>Double-Gang Plate includes Activate Mini Adapter Bezel for AF boxes (6A openings).</p>	<p>C8850P-2ACT</p>  <p>AC Series Communication Plate includes Activate Mini Adapter Bezel (AC-MAB) (6A openings).</p>

For other standard types of inserts and labeling options see ED683 for the full Activate System product offering.

RC Series Raised Floor Boxes

Today's offices require new flexibility to accommodate changing technologies. Building designers are looking for ways to lower installation costs. The FloorSource RC Series round flush floor box is the perfect solution.

The RC Series is available in three styles, two of which include a unique slide feature over the receptacle that keeps dirt and dust out of the devices when they are not activated.

The RC Series provides a flush, aesthetically pleasing solution for low-profile installations. It has a standard gray carpet flange that is also available in a black and a forged-brass finish. All styles in the RC Series come pre-assembled for ease of installation.

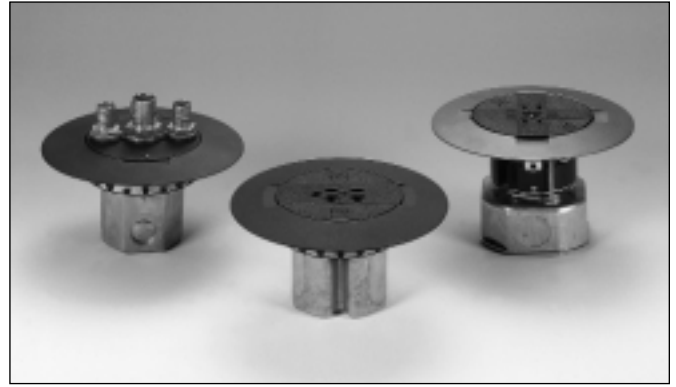

The RC Series feature a unique slide feature over the receptacle that helps eliminate the accumulation of dirt and dust when not activated.

Features & Benefits

- **Flush profile.** Provides an aesthetic appearance.
- **Round design.** Allows for easy installation, orientation in any direction.
- **Multiple service capability.** Allows single or double duplex receptacles and communications/data service in one unit.
- **Poke-thru style gripper pad.** For easy installation.

Ordering Information for RC Series Raised Floor Boxes

Catalog No./Item	Description/Specifications
RC860	Assembled Dual Service Unit - Std gray finish prewired with 15A receptacle from J-Box.
RC860-20A	Assembled Dual Service Unit - Std gray finish prewired with 20A receptacle from J-Box.
RC800-Q	Assembled Dual Service Unit - Std gray finish prewired with 15A Quad receptacle.
RC860-6	Assembled Dual Service Unit - Std gray finish complete with two 1/2" [12.7mm] and one 3/4" [19.1mm] connector plugs.

NOTE: Catalog numbers listed above have optional black and solid brass flanges available.

RC Series Raised Floor Boxes

Catalog No. RC860-20A

Total Depth - 3.194" [81mm]

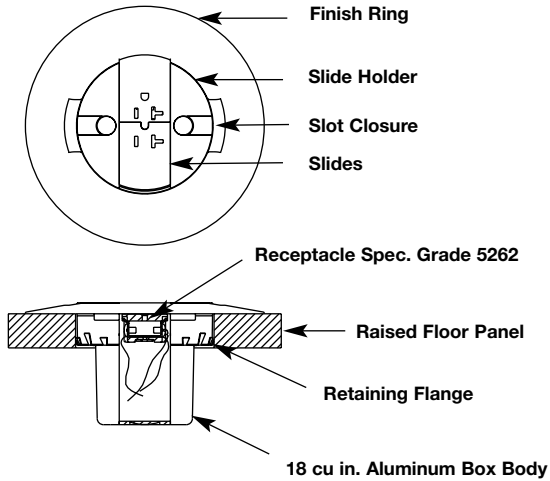

Catalog No. RC860-6

Total Depth - 3.194" [81mm]

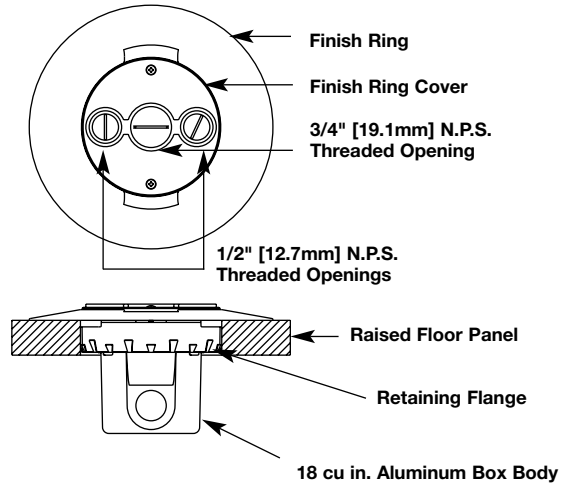

Catalog No. RC800-Q

Total Depth - 4.151" [105mm]

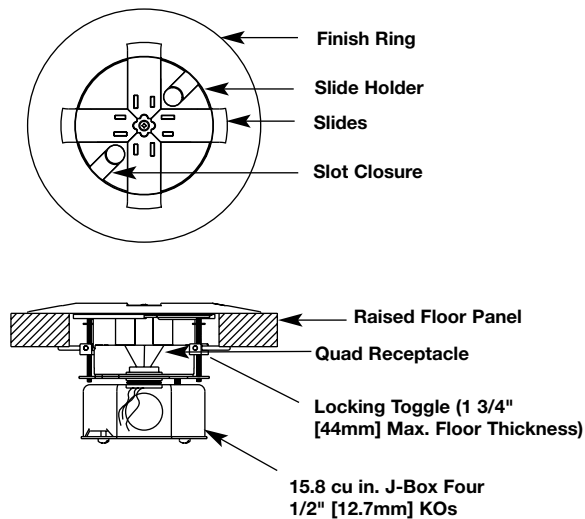

NOTE: Use a 4" [102mm] hole saw with outside diameter of 4 1/16" [103mm].

WIREMOLD®
Walker® Infloor Systems

The Wiremold Company

In U.S.:
60 Woodlawn Street • West Hartford, CT 06110
1-800-621-0049 • FAX 860-232-2062

In Canada:
850 Gartshore Street • Fergus, Ontario N1M 2W8
1-800-741-7957 • FAX 519-843-5980

International Sales:

1000 Innovation Drive • Williamstown, WV 26187
304-375-1093 • FAX 304-375-1099

