

# SOM-6765

## Intel® Atom™ Processor COM-Express Type 2 Compact Module

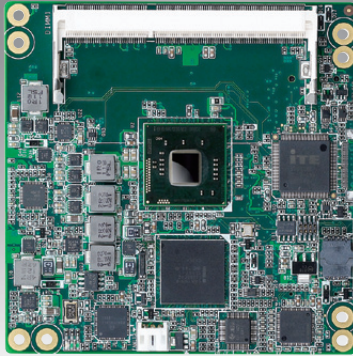





**NEW**





iManager susiAccess  CE FCC

### Features

- Embedded Intel® Atom™ Processor N2600/N2800/D2550 + NM10
- Intel Gfx support DX9 and OpenGL 3.0
- Supports VGA, 18/24 bit LVDS
- Supports DDR3 memory up to 1066 4GB
- Supports 2 PCIe x1, 4 PCI Master, LPC, SMBus, I2C Bus, 2 SATAII, EIDE, 8 USB2.0, GbE
- Supports iManager, SUSIAccess and Embedded Software APIs

**Software APIs:**  Watchdog  PC  SMBus  H/W Monitor  GPIO  Brightness Control

**Utilities:**  BIOS flash  Monitoring  Embedded Security ID

### Specifications

Form Factor	COM-Express R2.0 Compact Module, Type 2 Pin-out.			
Processor System	CPU	Intel Atom Processor N2600 1.6 GHz, 2 x 512 KB L2 Cache Intel Atom Processor N2800 1.86GHz, 2 x 512 KB L2 Cache Intel Atom Processor D2550 1.86GHz, 2 x 512KB L2 Cache		
	System Chipset	NM10		
	BIOS	AMI 16 Mbit Flash BIOS		
Memory	Technology	Support DDR3 1066 MHz for N2800/D2550, DDR3 800 MHz for N2600		
	Max. Capacity	Up to 4 GB for N2800/D2550, up to 2 GB for N2600		
	Socket	1 x 204-pin SODIMM Socket		
Display	Chipset	Intel Gfx integrated in Atom Processor		
	Graphic Engine	Intel Gfx 640 MHz for N2800/D2550: 400 MHz for N2600, supports DX9, OpenGL 3.0, MPEG2/VC1/H.264 HW Decoder		
	LVDS	18-bit up to 1366x768 for N2600/N2800 and 24-bit up to 1440 x 900 for D2550		
	VGA	1920 x 1200		
	Digital Display Interface	2 ports shared with HDMI/DVI/DisplayPort (Option)		
	TV Out	-		
	SDVO	-		
Dual Display	CRT + LVDS, CRT + DDI (Option)			
	LVDS + DDI (Option)			
Ethernet	Chipset	Intel 82583 Gigabit Ethernet		
	Speed	10/100/1000 Mbps		
WatchDog Timer	65536 level timer interval, from 0-65535 sec, multi-level, multi-option watchdog timer			
Expansion	2 PCIe x1 (Option for 4 PCIe x1), 4 PCI masters, LPC, SMBus, I2C Bus			
I/O	PATA	1 EIDE (UDMA 100)		
	SATA	2 SATAII (300 MB/s)		
	USB	8 USB 2.0		
	Audio	High definition audio interface		
	GPIO	8-bit GPIO		
Power	Power Type	ATX, AT		
	Power Supply Voltage	+12 V and +5 VSB for ATX, +12V for AT		
	Power Consumption (Typical)	6765N2600 (2G DDRIII 800)	6765D2550 (4G DDRII 1066)	6765N2800 (4G DDRIII 1066)
		+12 V @ 0.5 A	+12 V @ 0.67 A	+12 V @ 0.58 A
	Power Consumption (Max, test in Burn In Test)	6765N2600 (2G DDRIII 800)	6765D2550 (4G DDRIII 1066)	6765N2800 (4G DDRIII 1066)
	+12 V @ 0.65 A	+12 V @ 0.8 A	+12 V @ 0.79 A	
Environment	Operating Temperature	0 - 60° C (32 - 140° F)		
	Operating Humidity	0% - 90% relative humidity, non-condensing		
Mechanical	Dimensions	95 x 95 mm (3.74" x 3.74")		

## Block Diagram

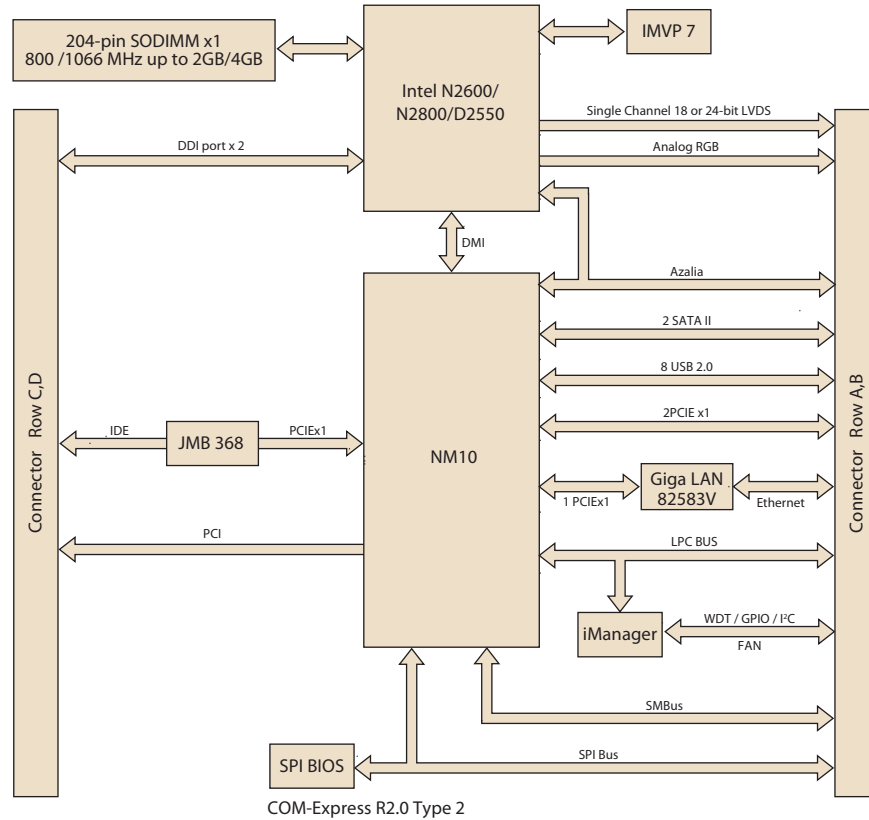

COM-Express R2.0 Type 2

## Ordering Information

Part No.	CPU	L2 Cache	Chipset	LVDS	VGA	HDMI/DVI/DisplayPort (Option)	Giga LAN	HD Audio	PCIe x1	PCI	USB 2.0	SATA II	LPC	SMBus	iC Bus	ATX Power	AT Power	Thermal Solution	Operating Temp.
SOM-6765N-S6A1E	Atom N2600	1 MB	NM10	18-bit	Yes	2	1	Yes	2	4	8	2	1	1	1	Yes	Yes	Passive	0 ~ 60° C
SOM-6765NZ-S6A1E	Atom N2600	1 MB	NM10	18-bit	Yes	2	1	Yes	2	4	8	2	1	1	1	Yes	Yes	Passive	-20 ~ 80° C
SOM-6765NZ2-S6A1E	Atom N2600	1 MB	NM10	18-bit	Yes	2	1	Yes	2	4	8	2	1	1	1	Yes	Yes	Passive	-40 ~ 85° C
SOM-6765N-S8A1E	Atom N2800	1 MB	NM10	18-bit	Yes	2	1	Yes	2	4	8	2	1	1	1	Yes	Yes	Passive	0 ~ 60° C
SOM-6765NZ-S8A1E	Atom N2800	1 MB	NM10	18-bit	Yes	2	1	Yes	2	4	8	2	1	1	1	Yes	Yes	Passive	-20 ~ 80° C
SOM-6765NZ2-S8A1E	Atom N2800	1 MB	NM10	18-bit	Yes	2	1	Yes	2	4	8	2	1	1	1	Yes	Yes	Passive	-40 ~ 85° C
SOM-6765D-S8A1E	Atom D2550	1 MB	NM10	24-bit	Yes	2	1	Yes	2	4	8	2	1	1	1	Yes	Yes	Active	0 ~ 60° C
SOM-6765DZ-S8A1E	Atom D2550	1 MB	NM10	24-bit	Yes	2	1	Yes	2	4	8	2	1	1	1	Yes	Yes	Active	-20 ~ 80° C
SOM-6765DZ2-S8A1E	Atom D2550	1 MB	NM10	24-bit	Yes	2	1	Yes	2	4	8	2	1	1	1	Yes	Yes	Active	-40 ~ 85° C

Note: Passive = fanless; Active = with fan

## Development Board

Part No.	Description
SOM-DB5700G-00A2E	Development board for COM-Express GLAN Rev.A2

## Optional Accessories

Part No.	Description
1960048815N001	Semi-Heatsink 95 x 95 x 17 mm
1960048819N001	Semi-Cooler 95 x 95 x 33.5 mm with 12V fan

## Packing List

Part No.	Description	Quantity
-	SOM-6765 CPU Module	1
1960053504N001	Heatspreader	1