



JQE Power Supplies

## JQE MODEL TABLE

MODEL	d-c OUTPUT RANGE		OUTPUT IMPEDANCE				MAX. INPUT AMPS at 125V a-c
	VOLTS	AMPS	VOLTAGE MODE		CURRENT MODE		
			SERIES R	SERIES L <sup>(1)</sup>	SHUNT R	SHUNT C <sup>(2)</sup>	
<b>QUARTER-RACK</b>							
JQE 6-10M	0-6	0-10	30μΩ	1μH	50kΩ	3kμF	2.0
JQE 15-6M	0-15	0-6	125μΩ	1μH	84kΩ	1kμF	2.1
JQE 25-4M	0-25	0-4	300μΩ	1μH	125kΩ	700μF	2.2
JQE 36-3M	0-36	0-3	600μΩ	1μH	165kΩ	400μF	2.2
JQE 55-2M	0-55	0-2	1.4mΩ	1μH	250kΩ	220μF	2.3
JQE 75-1.5M	0-75	0-1.5	2.5mΩ	1μH	330kΩ	160μF	2.3
JQE 100-1M	0-100	0-1	5mΩ	2μH	500kΩ	110μF	2.1
<b>HALF-RACK</b>							
JQE 6-22M	0-6	0-22	14μΩ	0.5μH	23kΩ	5.8kμF	4.2
JQE 6-45M	0-6	0-45	7μΩ	0.5μH	11kΩ	8kμF	9.0
JQE 15-12M	0-15	0-12	63μΩ	0.5μH	42kΩ	2.7kμF	4.0
JQE 15-25M	0-15	0-25	30μΩ	0.5μH	20kΩ	4.5kμF	8.4
JQE 25-10M	0-25	0-10	125μΩ	0.5μH	50kΩ	2.4kμF	5.3
JQE 25-20M	0-25	0-20	63μΩ	0.5μH	25kΩ	4.3kμF	10.5
JQE 36-8M	0-36	0-8	225μΩ	0.5μH	62.5kΩ	1.4kμF	6.0
JQE 36-15M	0-36	0-15	120μΩ	0.5μH	33kΩ	3.6kμF	9.5
JQE 55-5M	0-55	0-5	550μΩ	1μH	100kΩ	850μF	5.0
JQE 55-10M	0-55	0-10	275μΩ	1μH	50kΩ	2.1kμF	9.0
JQE 75-3M	0-75	0-3	1.25mΩ	1μH	165kΩ	850μF	4.0
JQE 75-8M	0-75	0-8	469μΩ	1μH	62.5kΩ	1.2kμF	10.0
JQE 100-2.5M	0-100	0-2.5	2mΩ	1μH	200kΩ	600μF	4.5
JQE 100-5M	0-100	0-5	1.25mΩ	1μH	100kΩ	600μF	8.4
JQE 150-1.5M	0-150	0-1.5	5mΩ	2μH	330kΩ	440μF	4.6
JQE 150-3.5M	0-150	0-3.5	2.2mΩ	2μH	140kΩ	440μF	8.7
<b>FULL-RACK</b>							
JQE 6-90M	0-6	0-90	3.5μΩ	0.5μH	3.5kΩ	17.6kμF	15.7
JQE 15-50M	0-15	0-50	15μΩ	0.5μH	10kΩ	12kμF	16.6
JQE 25-40M	0-25	0-40	31μΩ	0.5μH	12.5kΩ	14kμF	21.0
JQE 36-30M	0-36	0-30	60μΩ	0.5μH	16kΩ	11kμF	19.0
JQE 55-20M	0-55	0-20	138μΩ	1μH	25kΩ	7.3kμF	18.0
JQE 75-15M	0-75	0-15	250μΩ	1μH	33kΩ	4.2kμF	18.0
JQE 100-10M	0-100	0-10	0.62mΩ	1μH	50kΩ	2.2kμF	17.0
JQE 150-7M	0-150	0-7	1.1mΩ	2μH	72kΩ	1kμF	18.0

(1) For determining dynamic impedance in voltage mode.

(2) For determining dynamic impedance in current mode.

Series JQE power supplies are systems-type voltage stabilizers with current limiting. They are available in a variety of ratings: 100 watts in a 1/4-rack package, 250-500 watts in a 1/2-rack package, and 1000 watts in a full-rack package.

The tabulation of the effective series resistance and inductance in voltage mode and the effective shunt resistance and shunt capacitance in current mode, is done to allow a calculation of the output impedance versus frequency.

### FEATURES

- 10 turn voltage control for exceptional resolution.
- Analog output control by resistance: 1000Ω/Volt; or by a voltage delivering 0-1mA.
- Digital listen only control using SN-series digital interfaces.
- Current limited, front panel control (not programmable) 10%-105% I<sub>O</sub> max.
- JQE can control current with an external current-sense resistor.





Model JQE 25-4M Quarter Rack



Model JQE 100-2.5M Half Rack

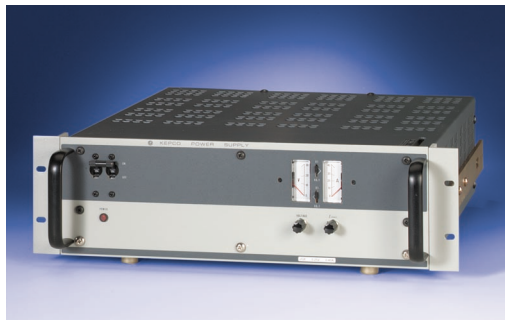

Model JQE 25-40M Full Rack



JQE are CE marked per the Low Voltage Directive (LVD), EN61010-1.



## JQE GENERAL SPECIFICATIONS

SPECIFICATION	RATING/DESCRIPTION	CONDITION	
<b>INPUT</b>			
a-c Voltage	105-125, 210-250V a-c	User selectable	
Current	See model table	Max load, 115V a-c	
Frequency	47-65Hz	Range	
<b>OUTPUT</b>			
d-c Output	Series pass	Transistor	
Type of Stabilizer	Voltage stabilizer	Current limited	
Voltage	0 to 100% of rating	Adjustment range for temp 0-71°C	
Current	0 to 100% of rating		
Error Sense	0.5V per load wire	Static voltage allowance	
Isolation Voltage	500V d-c or peak	Output to ground	
Leakage Current	<5 microamperes	rms at 115V a-c	
Output to Ground	<50 microamperes	p-p at 115V a-c	
Series Connection	500V	Max voltage off ground	
Parallel Connection	Automatic	Use current mode limiting	
	Current sharing	Use master-slave connection	
	Redundancy type	External steering diodes	
OVP	Not available		
<b>CONTROL</b>			
Type	Voltage	Fixed input, variable gain	
	Current	Differential comparison	
Voltage	Local	10-turn precision rheostat	
	Remote Analog	1000 ohms per volt or 0 to 1mA control current	
	Remote Digital	Use SN/SNR interface	12 bit Listen-only
Current	Local	Multiturn pot	
	Remote Analog	Not provided	See Series ATE models
Dynamics	Normal (slow)	dV/dt = I/C	See tabulated value of C in the model table
	Fast mode	Not provided	See Series ATE models
<b>MECHANICAL</b>			
Input Connection	Detachable IEC type 3-wire	¼ and ½ rack size	
	Permanently wired	Full rack size	
Output Connections	Front panel binding posts	Models under 15A	
	Rear barrier strip	¼ and ½ size	
	Rear compression studs	Full rack size	
Meters	Two 1½" vertical 3%, analog	Front panel	
Indicators	Neon	Pilot	
Mounting (in std 19" racks)	Use RA 24 rack adapter	¼ and ½ size	
	Mounting "ears" provided	Full rack	
Cooling	Forced air	Exhaust to rear	
Dimensions (HxWxD)	inches	5 <sup>7</sup> / <sub>32</sub> x 4 <sup>9</sup> / <sub>32</sub> x 17 <sup>3</sup> / <sub>16</sub>	¼ rack size
	mm	132.6 x 105.6 x 436.6	
	inches	5 <sup>7</sup> / <sub>32</sub> x 8 <sup>1</sup> / <sub>32</sub> x 17 <sup>3</sup> / <sub>8</sub>	½ rack size
mm	132.6 x 211.9 x 441.3		
inches	5 <sup>7</sup> / <sub>32</sub> x 19 x 17 <sup>1</sup> / <sub>4</sub>	Full rack size	
mm	177 x 482.6 x 504.8		
Finish: Fed Std 595	Light gray, color 26440	Front panel, 2 tone	
Weight (packed for shipment)	18lb (8.2Kg)	¼ rack size	
	37lb (16.8Kg)	½ rack size (250W)	
	49lb (22.3Kg)	½ rack size (500W)	
	97lb (44.1Kg)	Full rack size	

## JQE STATIC SPECIFICATIONS

INFLUENCE QUANTITY	OUTPUT EFFECTS		AMPLIFIER OFFSETS <sup>(6)</sup>		REFERENCE 6.2V±5%
	VOLTAGE MODE	CURRENT MODE <sup>(1)</sup>	VOLTAGE $\Delta E_{IO}$	CURRENT $\Delta I_{IO}$	
Source 105-125/210V a-c	<0.0005%	<0.005%	<10 $\mu$ V	<2nA	0.0001%
Load No load-full load	<0.005% or 0.2mV <sup>(2)</sup>	<0.01%	<200 $\mu$ V	<5nA	—
Time 8-hours (drift)	<0.01% or 1mV <sup>(2)</sup>	>0.02%	<20 $\mu$ V	<2nA	0.005%
Temp. Per °C	<0.01% <sup>(3)</sup>	<0.02% <sup>(3)</sup>	<20 $\mu$ V	<5nA	0.005%
Ripple and Noise <sup>(4)</sup>	rms p-p <sup>(5)</sup>	<0.2mV <0.1% of $I_O$ max.	—	—	—

- (1) External current sensing, using the voltage amplifier. Effects are measured for a 1-Volt current sensing voltage drop.
- (2) Whichever is greater.
- (3) Typical temperature effect coefficients are: 0.005% per °C voltage mode; 0.01% per °C externally sensed current mode.
- (4) One terminal grounded or connected so that the common-mode current does not flow through the load or (in current-mode) through a sensing resistor.
- (5) 20Hz to 10MHz.
- (6) The output effect can be calculated by the relationship:  

$$\Delta E_O = \pm E_r(R_f/R_i) \pm \Delta E_{IO}(1+R_f/R_i) \pm I_{IO}(R_f)$$
 where  $R_f$  is the feedback resistor, and  $R_i$  is the input resistor from the reference,  $E_r$ .

The tabulated offsets, more particularly their change as a function of source, time and temperature, allow a user to calculate performance of the uncommitted amplifier(s) with user specified input and feedback components. The formula for this is given in the static specifications table footnote.

### OUTLINE DIMENSIONAL DRAWINGS

Fractional dimensions in light face type are in inches, dimensions in bold face type are in millimeters.  
 Tolerance:  $\pm 1/64"$  (0.4) between mounting holes  
 $\pm 1/32"$  (0.8) other dimensions  
 Panels: Per Mil. Std. 189

The 1/4 rack and 1/2 rack size JQE power supplies can be rack mounted using RA 24. See page 77.

### JQE QUARTER-RACK MODELS

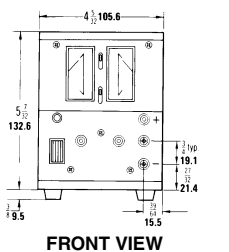

FRONT VIEW

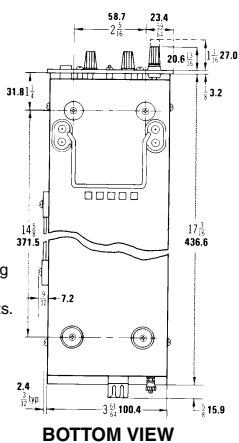

BOTTOM VIEW

To rack mount, remove handle, feet and bail. Use (4) 8-18 x 5/8" thread cutting screws into plastic inserts.

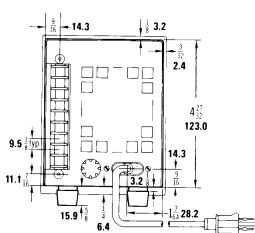

REAR VIEW

### JQE HALF-RACK MODELS

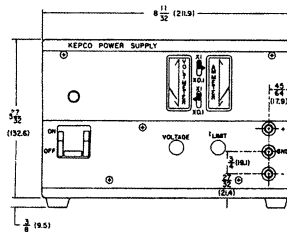

FRONT VIEW

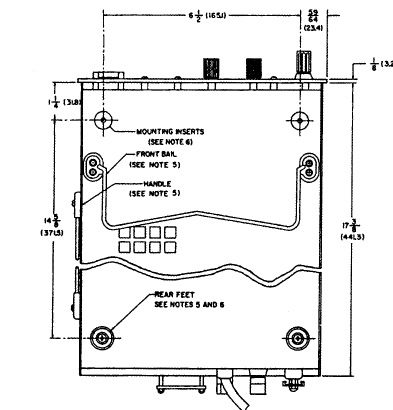

BOTTOM VIEW

To rack mount, remove handle, feet and bail. Use (4) 8-18 x 5/8" thread cutting screws into plastic inserts.

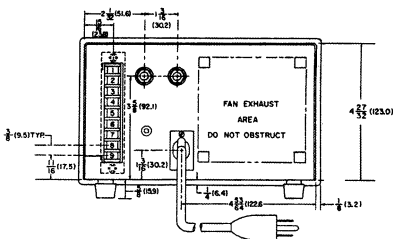

REAR VIEW

### JQE FULL-RACK MODELS

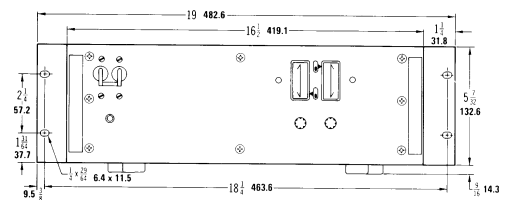

FRONT VIEW

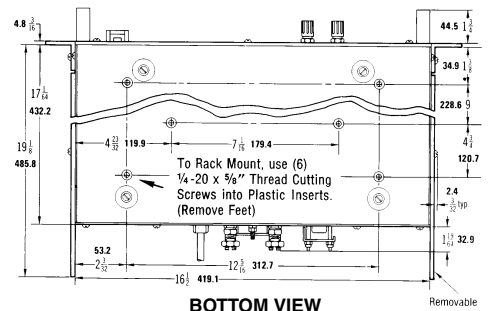

BOTTOM VIEW

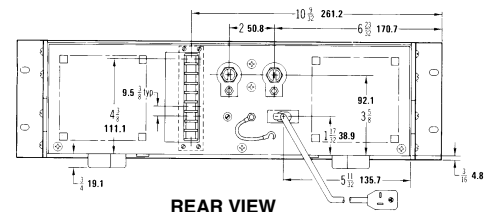

REAR VIEW

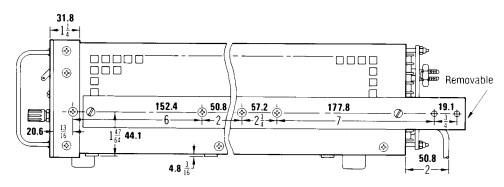

SIDE VIEW