

General Purpose Transistors

NPN Silicon

2N4401

ON Semiconductor Preferred Device

MAXIMUM RATINGS

Rating	Symbol	Value	Unit
Collector–Emitter Voltage	V_{CE0}	40	Vdc
Collector–Base Voltage	V_{CB0}	60	Vdc
Emitter–Base Voltage	V_{EB0}	6.0	Vdc
Collector Current — Continuous	I_C	600	mAdc
Total Device Dissipation @ $T_A = 25^\circ\text{C}$ Derate above 25°C	P_D	625 5.0	mW mW/°C
Total Device Dissipation @ $T_C = 25^\circ\text{C}$ Derate above 25°C	P_D	1.5 12	Watts mW/°C
Operating and Storage Junction Temperature Range	T_J, T_{stg}	-55 to +150	°C

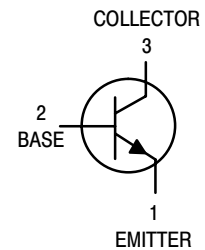
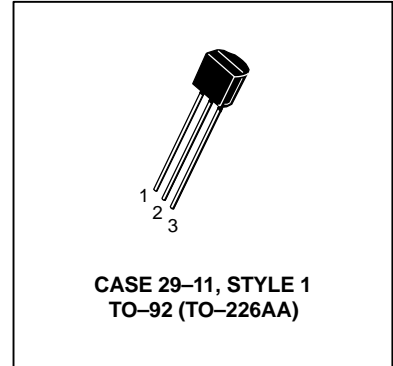

THERMAL CHARACTERISTICS

Characteristic	Symbol	Max	Unit
Thermal Resistance, Junction to Ambient	$R_{\theta JA}$	200	°C/W
Thermal Resistance, Junction to Case	$R_{\theta JC}$	83.3	°C/W

ELECTRICAL CHARACTERISTICS ($T_A = 25^\circ\text{C}$ unless otherwise noted)

Characteristic	Symbol	Min	Max	Unit
----------------	--------	-----	-----	------

OFF CHARACTERISTICS

Collector–Emitter Breakdown Voltage ⁽¹⁾ ($I_C = 1.0 \text{ mAdc}, I_B = 0$)	$V_{(BR)CEO}$	40	—	Vdc
Collector–Base Breakdown Voltage ($I_C = 0.1 \text{ mAdc}, I_E = 0$)	$V_{(BR)CBO}$	60	—	Vdc
Emitter–Base Breakdown Voltage ($I_E = 0.1 \text{ mAdc}, I_C = 0$)	$V_{(BR)EBO}$	6.0	—	Vdc
Base Cutoff Current ($V_{CE} = 35 \text{ Vdc}, V_{EB} = 0.4 \text{ Vdc}$)	I_{BEV}	—	0.1	μAdc
Collector Cutoff Current ($V_{CE} = 35 \text{ Vdc}, V_{EB} = 0.4 \text{ Vdc}$)	I_{CEX}	—	0.1	μAdc

1. Pulse Test: Pulse Width $\leq 300 \mu\text{s}$, Duty Cycle $\leq 2.0\%$.

Preferred devices are ON Semiconductor recommended choices for future use and best overall value.

2N4401

ELECTRICAL CHARACTERISTICS ($T_A = 25^\circ\text{C}$ unless otherwise noted) (Continued)

Characteristic	Symbol	Min	Max	Unit
ON CHARACTERISTICS(1)				
DC Current Gain ($I_C = 0.1 \text{ mAdc}$, $V_{CE} = 1.0 \text{ Vdc}$) ($I_C = 1.0 \text{ mAdc}$, $V_{CE} = 1.0 \text{ Vdc}$) ($I_C = 10 \text{ mAdc}$, $V_{CE} = 1.0 \text{ Vdc}$) ($I_C = 150 \text{ mAdc}$, $V_{CE} = 1.0 \text{ Vdc}$) ($I_C = 500 \text{ mAdc}$, $V_{CE} = 2.0 \text{ Vdc}$)	h_{FE}	20 40 80 100 40	— — — 300 —	—
Collector–Emitter Saturation Voltage ($I_C = 150 \text{ mAdc}$, $I_B = 15 \text{ mAdc}$) ($I_C = 500 \text{ mAdc}$, $I_B = 50 \text{ mAdc}$)	$V_{CE(sat)}$	— —	0.4 0.75	Vdc
Base–Emitter Saturation Voltage ($I_C = 150 \text{ mAdc}$, $I_B = 15 \text{ mAdc}$) ($I_C = 500 \text{ mAdc}$, $I_B = 50 \text{ mAdc}$)	$V_{BE(sat)}$	0.75 —	0.95 1.2	Vdc

SMALL–SIGNAL CHARACTERISTICS

Current–Gain — Bandwidth Product ($I_C = 20 \text{ mAdc}$, $V_{CE} = 10 \text{ Vdc}$, $f = 100 \text{ MHz}$)	f_T	250	—	MHz
Collector–Base Capacitance ($V_{CB} = 5.0 \text{ Vdc}$, $I_E = 0$, $f = 1.0 \text{ MHz}$)	C_{cb}	—	6.5	pF
Emitter–Base Capacitance ($V_{EB} = 0.5 \text{ Vdc}$, $I_C = 0$, $f = 1.0 \text{ MHz}$)	C_{eb}	—	30	pF
Input Impedance ($I_C = 1.0 \text{ mAdc}$, $V_{CE} = 10 \text{ Vdc}$, $f = 1.0 \text{ kHz}$)	h_{ie}	1.0	15	k ohms
Voltage Feedback Ratio ($I_C = 1.0 \text{ mAdc}$, $V_{CE} = 10 \text{ Vdc}$, $f = 1.0 \text{ kHz}$)	h_{re}	0.1	8.0	$\times 10^{-4}$
Small–Signal Current Gain ($I_C = 1.0 \text{ mAdc}$, $V_{CE} = 10 \text{ Vdc}$, $f = 1.0 \text{ kHz}$)	h_{fe}	40	500	—
Output Admittance ($I_C = 1.0 \text{ mAdc}$, $V_{CE} = 10 \text{ Vdc}$, $f = 1.0 \text{ kHz}$)	h_{oe}	1.0	30	μmhos

SWITCHING CHARACTERISTICS

Delay Time	($V_{CC} = 30 \text{ Vdc}$, $V_{BE} = 2.0 \text{ Vdc}$, $I_C = 150 \text{ mAdc}$, $I_{B1} = 15 \text{ mAdc}$)	t_d	—	15	ns
Rise Time		t_r	—	20	ns
Storage Time	($V_{CC} = 30 \text{ Vdc}$, $I_C = 150 \text{ mAdc}$, $I_{B1} = I_{B2} = 15 \text{ mAdc}$)	t_s	—	225	ns
Fall Time		t_f	—	30	ns

1. Pulse Test: Pulse Width $\leq 300 \mu\text{s}$, Duty Cycle $\leq 2.0\%$.

SWITCHING TIME EQUIVALENT TEST CIRCUITS

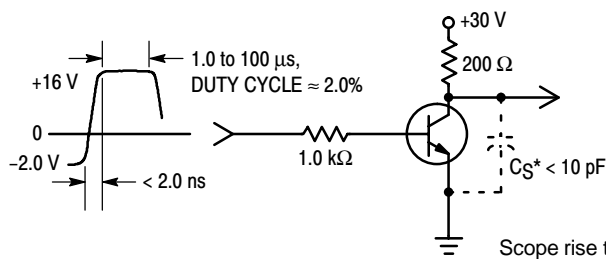

Figure 1. Turn–On Time

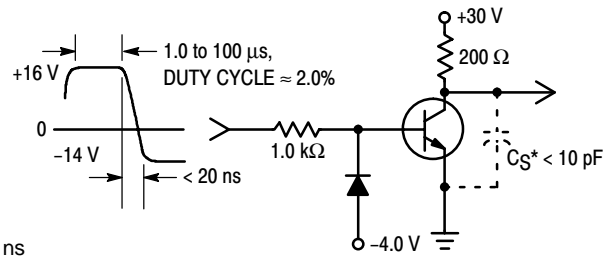

Figure 2. Turn–Off Time

Scope rise time $< 4.0 \text{ ns}$
*Total shunt capacitance of test jig connectors, and oscilloscope

2N4401

TRANSIENT CHARACTERISTICS

— 25°C - - - 100°C

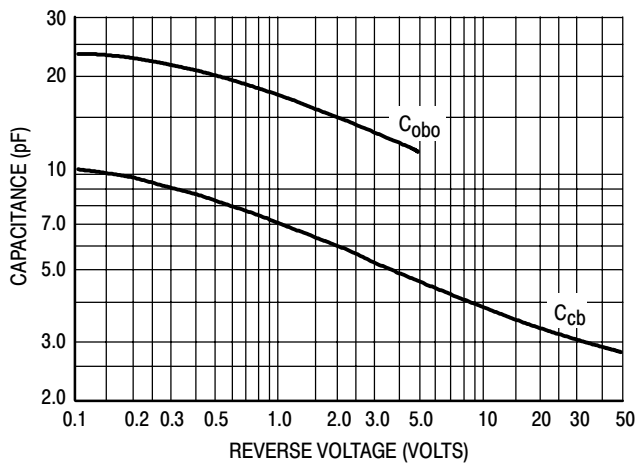

Figure 3. Capacitances

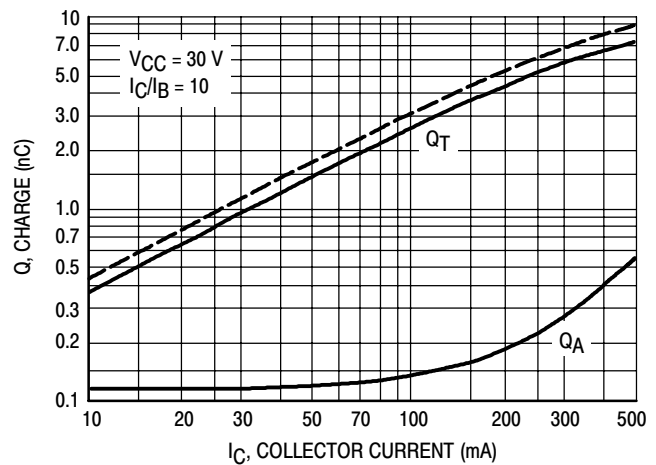

Figure 4. Charge Data

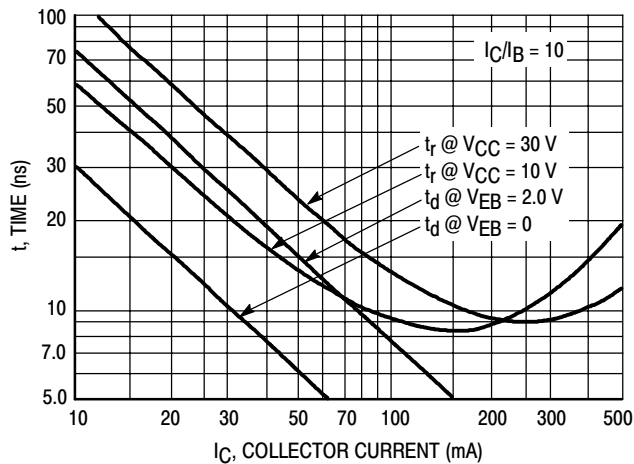

Figure 5. Turn-On Time

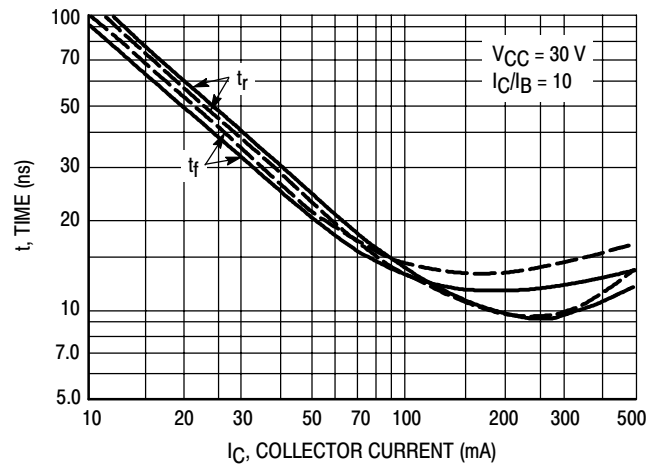

Figure 6. Rise and Fall Times

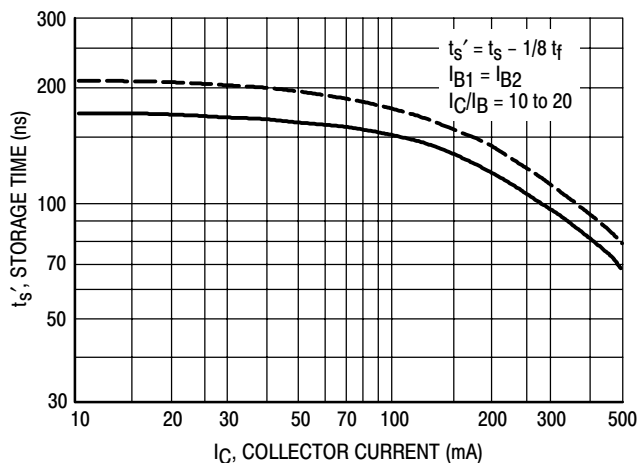

Figure 7. Storage Time

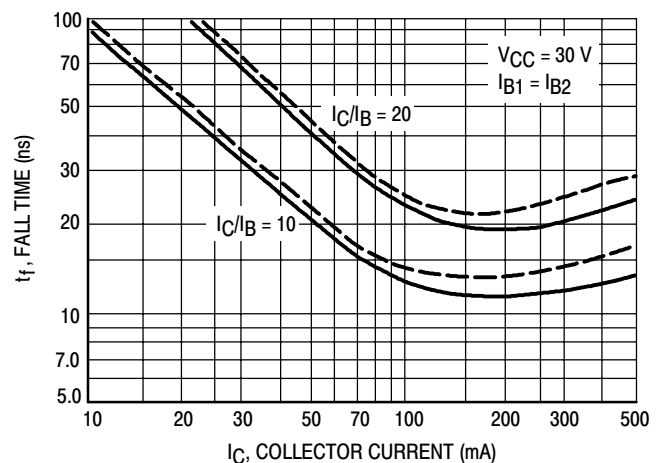

Figure 8. Fall Time

2N4401

SMALL-SIGNAL CHARACTERISTICS NOISE FIGURE

$V_{CE} = 10 \text{ Vdc}$, $T_A = 25^\circ\text{C}$; Bandwidth = 1.0 Hz

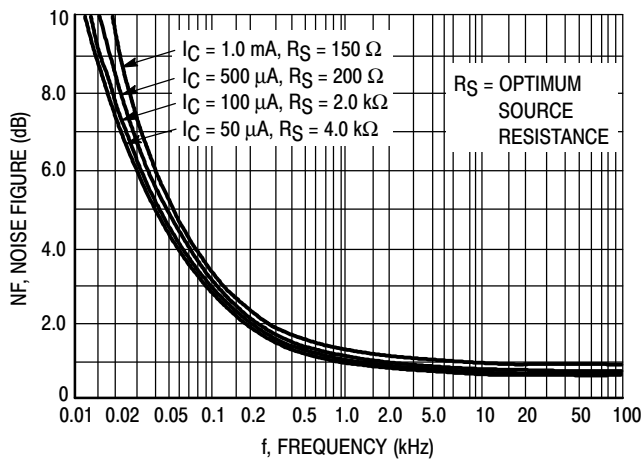

Figure 9. Frequency Effects

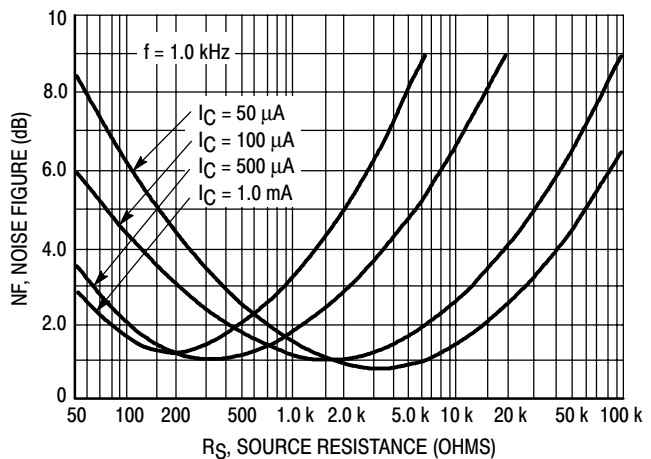

Figure 10. Source Resistance Effects

h PARAMETERS

$V_{CE} = 10 \text{ Vdc}$, $f = 1.0 \text{ kHz}$, $T_A = 25^\circ\text{C}$

This group of graphs illustrates the relationship between h_{fe} and other “h” parameters for this series of transistors. To obtain these curves, a high-gain and a low-gain unit were

selected from the 2N4401 lines, and the same units were used to develop the correspondingly numbered curves on each graph.

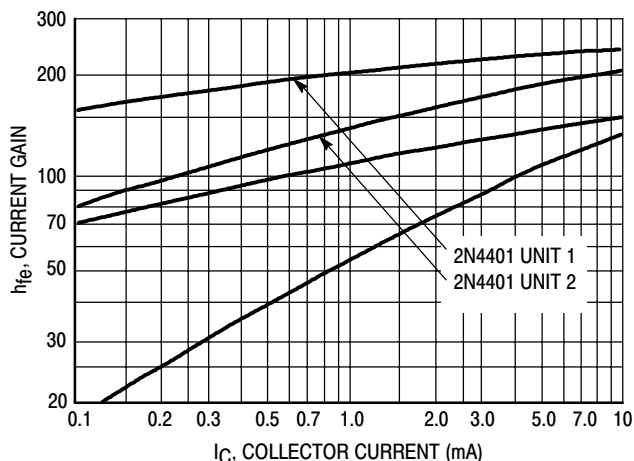

Figure 11. Current Gain

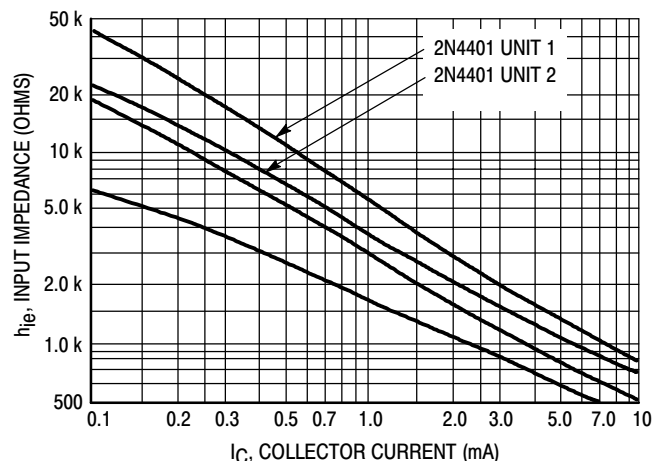

Figure 12. Input Impedance

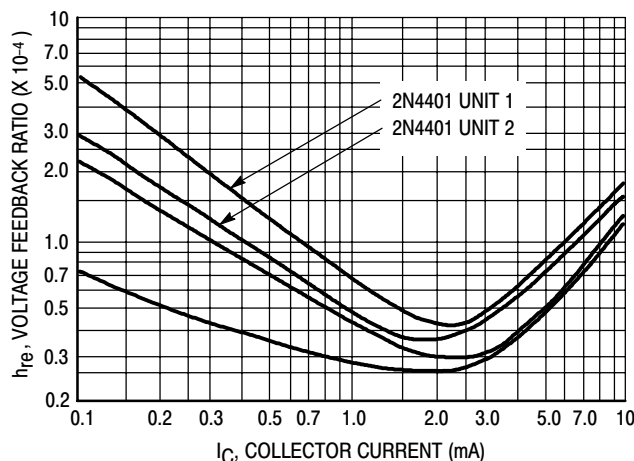

Figure 13. Voltage Feedback Ratio

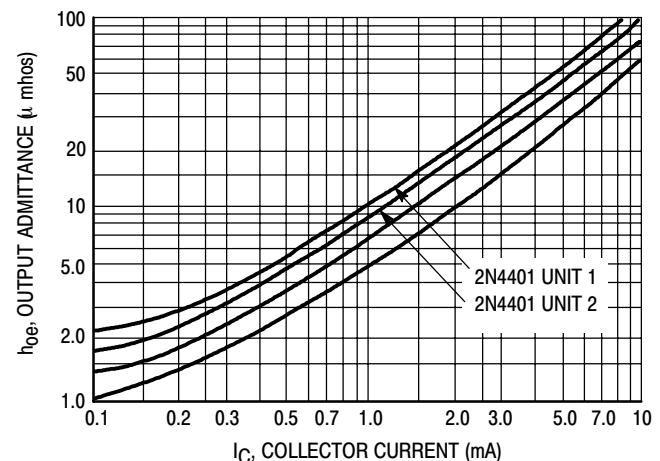

Figure 14. Output Admittance

2N4401

STATIC CHARACTERISTICS

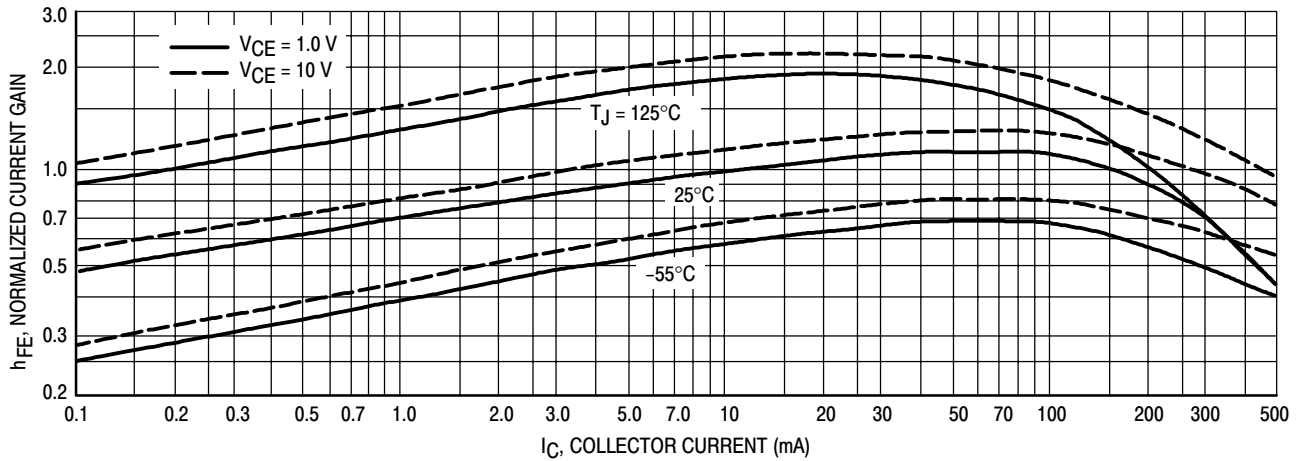

Figure 15. DC Current Gain

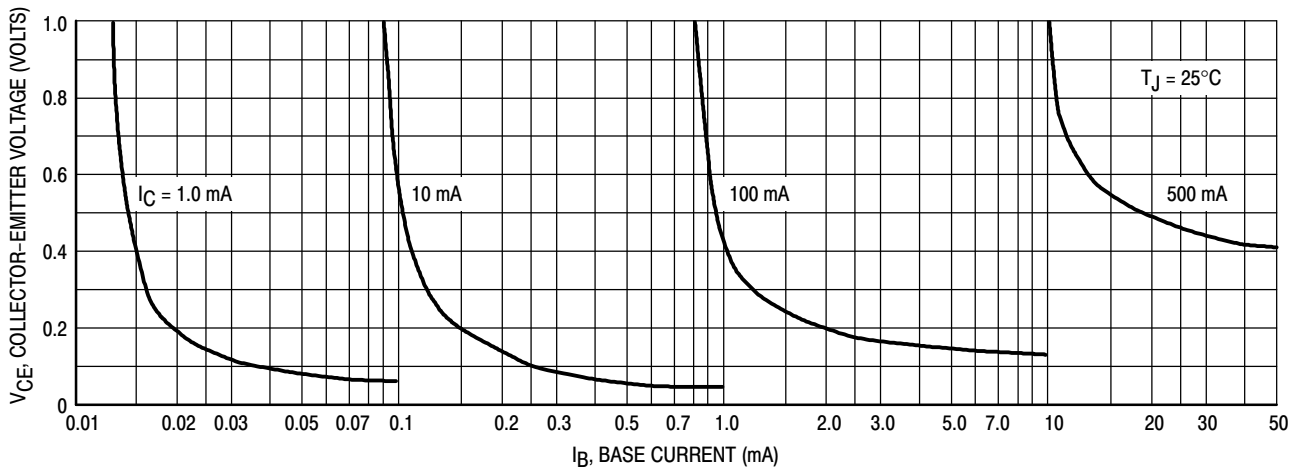

Figure 16. Collector Saturation Region

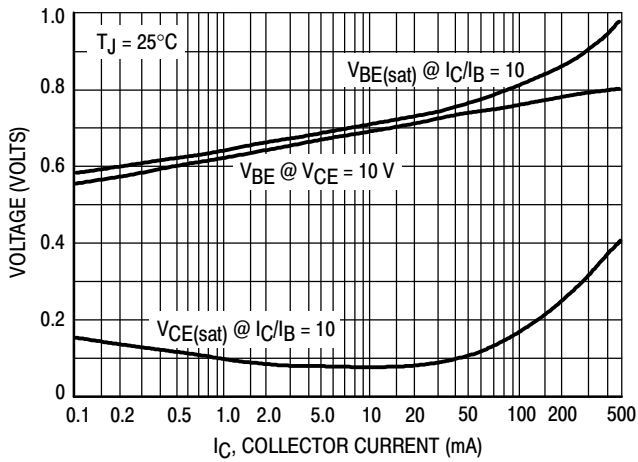

Figure 17. "On" Voltages

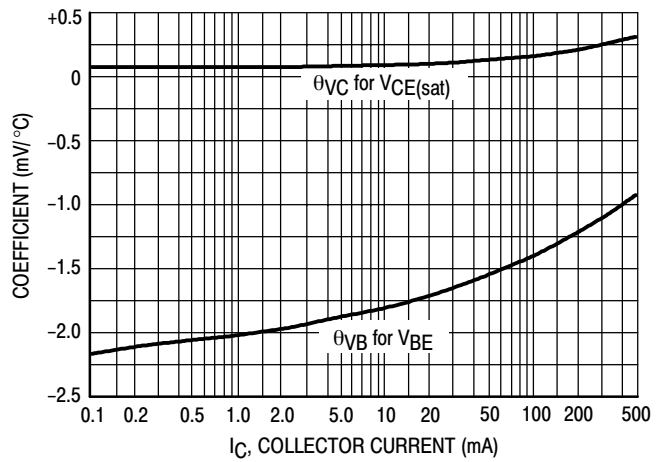
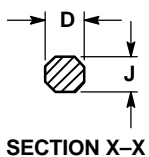
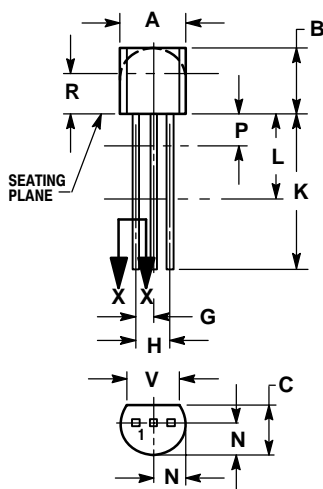

Figure 18. Temperature Coefficients

2N4401

PACKAGE DIMENSIONS

TO-92 (TO-226)
CASE 29-11
ISSUE AL



STYLE 1:
PIN 1. EMITTER
2. BASE
3. COLLECTOR

NOTES:

1. DIMENSIONING AND TOLERANCING PER ANSI Y14.5M, 1982.
2. CONTROLLING DIMENSION: INCH.
3. CONTOUR OF PACKAGE BEYOND DIMENSION R IS UNCONTROLLED.
4. LEAD DIMENSION IS UNCONTROLLED IN P AND BEYOND DIMENSION K MINIMUM.

DIM	INCHES		MILLIMETERS	
	MIN	MAX	MIN	MAX
A	0.175	0.205	4.45	5.20
B	0.170	0.210	4.32	5.33
C	0.125	0.165	3.18	4.19
D	0.016	0.021	0.407	0.533
G	0.045	0.055	1.15	1.39
H	0.095	0.105	2.42	2.66
J	0.015	0.020	0.39	0.50
K	0.500	---	12.70	---
L	0.250	---	6.35	---
N	0.080	0.105	2.04	2.66
P	---	0.100	---	2.54
R	0.115	---	2.93	---
V	0.135	---	3.43	---

Notes

ON Semiconductor and  are trademarks of Semiconductor Components Industries, LLC (SCILLC). SCILLC reserves the right to make changes without further notice to any products herein. SCILLC makes no warranty, representation or guarantee regarding the suitability of its products for any particular purpose, nor does SCILLC assume any liability arising out of the application or use of any product or circuit, and specifically disclaims any and all liability, including without limitation special, consequential or incidental damages. "Typical" parameters which may be provided in SCILLC data sheets and/or specifications can and do vary in different applications and actual performance may vary over time. All operating parameters, including "Typicals" must be validated for each customer application by customer's technical experts. SCILLC does not convey any license under its patent rights nor the rights of others. SCILLC products are not designed, intended, or authorized for use as components in systems intended for surgical implant into the body, or other applications intended to support or sustain life, or for any other application in which the failure of the SCILLC product could create a situation where personal injury or death may occur. Should Buyer purchase or use SCILLC products for any such unintended or unauthorized application, Buyer shall indemnify and hold SCILLC and its officers, employees, subsidiaries, affiliates, and distributors harmless against all claims, costs, damages, and expenses, and reasonable attorney fees arising out of, directly or indirectly, any claim of personal injury or death associated with such unintended or unauthorized use, even if such claim alleges that SCILLC was negligent regarding the design or manufacture of the part. SCILLC is an Equal Opportunity/Affirmative Action Employer.

PUBLICATION ORDERING INFORMATION

Literature Fulfillment:

Literature Distribution Center for ON Semiconductor
P.O. Box 5163, Denver, Colorado 80217 USA
Phone: 303-675-2175 or 800-344-3860 Toll Free USA/Canada
Fax: 303-675-2176 or 800-344-3867 Toll Free USA/Canada
Email: ONlit@hibbertco.com

N. American Technical Support: 800-282-9855 Toll Free USA/Canada

JAPAN: ON Semiconductor, Japan Customer Focus Center
4-32-1 Nishi-Gotanda, Shinagawa-ku, Tokyo, Japan 141-0031
Phone: 81-3-5740-2700
Email: r14525@onsemi.com

ON Semiconductor Website: <http://onsemi.com>

For additional information, please contact your local Sales Representative.