



PROCESS AUTOMATION

INSTALLATION AND OPERATION MANUAL

SK-KVM-XXX SERIES STATION EXTENDERS





Table of contents

I. System introduction	2
II. SK-KVM-XXX-NR - CAT5, VGA & PS2	4
Models	5
Cables	5
Installation	6
Division 2 mounting bracket	6
Applying power	6
Keyboard commands	7
Adjusting the video	8
Product specifications	10
Troubleshooting	10
III. SK-KVM-XXX-CW - CAT5, DVI & USB	12
Models	13
Cables	13
Installation	13
Division 2 mounting bracket	14
Transmitter to receiver cabling	14
Applying power	14
LED indicators	14
Operating instructions-transmitter KVM access	15
DDC information	15
Product specifications	15
Troubleshooting	15
IV. SK-KVM-XXX-FW - DVI TO FIBER	16
Models	17
Cables	17
Installation	17
Division 2 mounting bracket	18
Transmitter to receiver cabling	18
Applying power	18
LED indicators	18
Operating instructions-transmitter KVM access	18
DDC information	19
Product specifications	19
Troubleshooting	19
V. SERVICE INFORMATION	20
VI. SAFETY	20
VII. FCC/IC STATEMENTS	21
VIII. EU DECLARATION OF CONFORMITY	21

System introduction

Thank you for choosing the Pepperl+Fuchs enhanced KVM operator workstation extender. The SK-KVM-XXX is the result of Pepperl+Fuchs commitment to providing state-of-the-art solutions for today's demanding workplace. The SK-KVM-XXX has proven to be a valuable investment for any business, big or small, that has a need to access host PCs from receiver locations.

The SK-KVM-XXX system consists of two units, a transmitter unit and a receiver unit. The transmitter unit connects to your host PC. The receiver unit connects to a keyboard, one monitor and a mouse. The transmitter and receiver units are connected together with industry-standard CAT-5, CAT-5e, or CAT-6 shielded or unshielded, solid core twisted-pair cable terminated with RJ45 connectors, or by means of fiber optic cable (model dependent). Pepperl+Fuchs' SK-KVM-XXX models can extend 400 feet to 1300 feet from the host PC.

Using the SK-KVM-XXX allows users to locate computers in a secure area and access them from other unsecured areas. Since the SK-KVM-XXX series is also rated for Class I/Div. 2 hazardous areas, computers used in safe industrial environments can be accessed receiverly in the hazardous location.

Features

- Extend a KVM operator workstation from a host PC using a single CAT-x cable: up to 650 feet at resolutions of 1600 x 1200 @ 60Hz, 1,000 feet for the resolutions of 1280 x 1024 @ 75Hz
- Extend a KVM operator workstation from a host PC using 50 µm multi-mode fiber cable: up to 1300 feet at resolutions of 1920 x 1200 @ 60Hz
- Supports industry-standard DVI or VGA video input
- Supports PCs, serial, and full stereo audio
- Supports PS/2 or USB keyboard/mouse and all PC video formats
- The SK-KVM-XXX uses a microprocessor to emulate the keyboard and mouse for plug and play operation.
- The keyboard and mouse on the receiver unit do not have to be connected for the PC to boot; only the transmitter unit must be connected to the PC
- Integrated skew compensation adjusts all colors
- Low frequency (LF) and high frequency (HF) equalization adjustments for optimum video tuning
- Compatible with Windows, Windows NT, OS/2, Unix, Linux and other operating systems
- Fully automatic KVM sharing on a first-come first-serve basis using the transmitter access model
- On a transmitter access unit, computers video is displayed on both KVM operator workstations monitors except in the private mode
- Transmitter or receiver KVM operator workstation can inhibit the other on the transmitter access models
- Stereo audio can be transmitted in either direction simultaneously. Many serial devices like a touchscreen can plug directly into the receiver unit (serial/audio model).
- Status indicator LEDs on each RJ45/Fiber connector
- Surge protection on each RJ45 port
- All settings and video tuning performed from the receiver unit and saved in flash memory
- Receiver unit is flash upgradeable



Compatibility

Computers	PCs with standard PS/2 or USB keyboards and mice
Monitors	VGA to UXGA HV, Composite, Sync-on-green, DVI-D
Keyboards	PS/2 or USB types of keyboard
Mouse	PS/2, USB (2- or 3-button), Wheel mouse Microsoft IntelliMouse
Serial devices	Touchscreens, graphic tablets, serial printers/plotters, computer terminals, serial mice, other standard asynchronous serial devices. Compatible up to 19.2 kBaud
Audio devices	Compatible sound cards Amplified or non-amplified microphone Amplified computer stereo speakers Other audio devices that transmit/receive signals less than 5 volts peak-to-peak

Pepperl+Fuchs' Web Site

Visit our web site at www.pepperl-fuchs.us for additional information on the SK-KVM-XXX and other products designed for industrial HMI applications.

Disclaimer

While every precaution has been taken in the preparation of this manual, the manufacturer assumes no responsibility for errors or omissions. Neither does the manufacturer assume any liability for damages resulting from the use of the information contained herein. The manufacturer reserves the right to change the specifications, functions, or circuitry of the product without notice.

The manufacturer cannot accept liability for damages due to misuse of the product or other circumstances outside the manufacturer's control. The manufacturer will not be responsible for any loss, damage, or injury arising directly or indirectly from the use of this product.

Model SK-KVM-XXX-NR CAT5, VGA & PS2

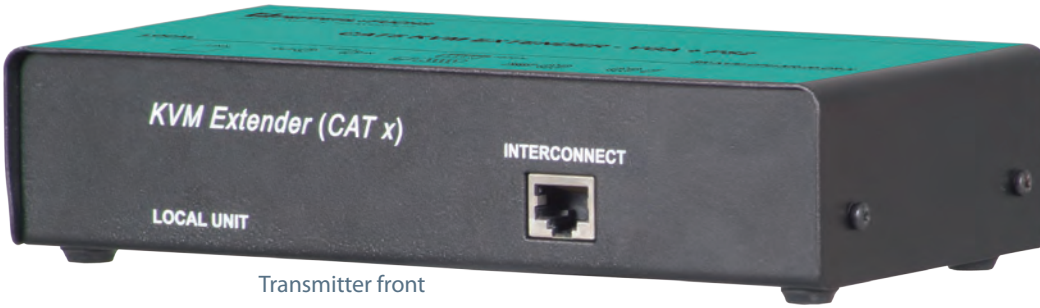

Transmitter front



Transmitter back



Receiver front



Receiver back



Single video models

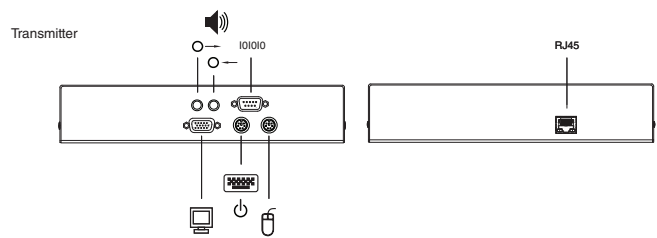

Figure 1. Transmitter

Connectors	
Front	
RJ45	CATx cable connection
Rear transmitter single with serial/audio	
HD15M	host PC video connection
MiniDin-6	(2) host PC keyboard and mouse connections
DB9F	Serial connector
Audio	(2) 3.5 mm stereo connectors

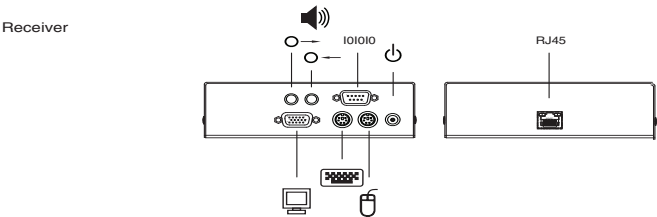

Figure 2. Receiver

Connectors	
Front	
RJ45	CATx cable connection (front panel)
Rear transmitter single with serial/audio	
HD15F	host PC video connection
MiniDin-6	(2) host PC keyboard and mouse connections
DB9M	Serial connector
Audio	(2) 3.5 mm stereo connectors
Power	9 V power adapter connector

Cables

Transmitter unit to host PC cable

A host PC adapter cable is used to connect from the transmitter unit to a host PC's keyboard, video monitor and mouse ports. The Serial/Audio models use a male-to-male cable configured on both ends with an HD15M VGA connector, two MiniDin-6 connectors for the PS/2 keyboard and mouse, a 3.5mm audio cable, and a DB9MF serial cable. Max transmitter unit to host PC cable length is 20 feet using standard cabling. Using coax cabling, this distance can be extended, but care should be taken because power for the transmitter unit is obtained from the connected host PC's keyboard port. Extended distances may require the use of an additional power supply for the transmitter unit.

Receiver unit to KVM workstation cable

The keyboard, video monitor, and mouse cables on a KVM operator workstation can connect directly to the SK-KVM-XXX-NT receiver unit or dual unit connectors if they are HD15M Video connector and PS/2, MiniDin-6 keyboard and mouse connectors. Stereo speakers and a microphone can connect directly to the receiver unit's audio ports.

Transmitter unit to receiver unit cable

The transmitter unit is connected to the receiver unit with up to 1,000 feet of standard CAT-x UTP/STP "solid core" cable terminated with RJ45 connectors.

Serial cable

To connect the transmitter unit to the host PC's DB9 serial port, you can use a standard DB9MF serial 1:1 (DTE-DCE) cable. The receiver units "SERIAL" port is wired as DTE (the same as the host PC's serial port). To connect a serial printer or other DTE devices to the receiver unit, you will need a null-modem (crossover) cable between the receiver unit and the device. Select Xon/Xoff software flow control on the printer and PC. A serial touchscreen can be connected directly to the receiver unit's serial port.

Audio cable

SK-KVM-XXX-NR models with audio are configured with two 3.5 mm stereo audio jacks on both the transmitter and receiver unit. Standard 3.5 mm stereo audio cables can be used to connect between the transmitter units "LINE IN" connector and a sound card's "LINE OUT" connector. The receiver unit's "LINE OUT" connects to a pair of powered computer speakers.

If you want to use a microphone on the receiver unit, follow this set-up:

- a) Connect the "LINE OUT" connector on the transmitter unit to the "MIC" input on the host PC's sound card
- b) Connect a microphone to the receiver units "LINE IN" connector
- c) Adjust the sound card to provide an additional +20dB of amplification.

NOTE: If you are using a powered microphone, connect it directly to the "LINE IN" connector on the receiver unit and connect the transmitter units "LINE OUT" connector to the sound cards "LINE IN" connector.

The video performance will vary with different cable types. The SK-KVM-XXX-NR makes it easy to adjust the skew and video compensation with simple keyboard commands.

Installation

Please refer to the safety section first before proceeding with any installation or configuration of the SK-KVM-XXX-NR.

Installation consists of three easy steps.

1. Connect the cables to the equipment
2. Applying power
3. Adjust the video channels (if needed)

For systems that only require running video through the SK-KVM-XXX-NR with no keyboard or mouse or use extended cable lengths between the transmitter unit and a computer or KVM switch, supplemental power should be supplied to the transmitter unit. The transmitter unit gets its power from the keyboard port of the host PC.

When installing the SK-KVM-XXX-NR, locate the transmitter unit as close as possible to the host PC. Keep the host PC and KVM cables as short as possible but still give some freedom of movement. Using shorter cables keeps the video noise to a minimum and reduces installation costs. Provide adequate air circulation to assure that the maximum operating temperature is not exceeded.

Wherever the SK-KVM-XXX-NR transmitter and receiver units are located, they should be on a secure surface and free from obstructions and objects that may cause damage to the units.

Connecting the cables

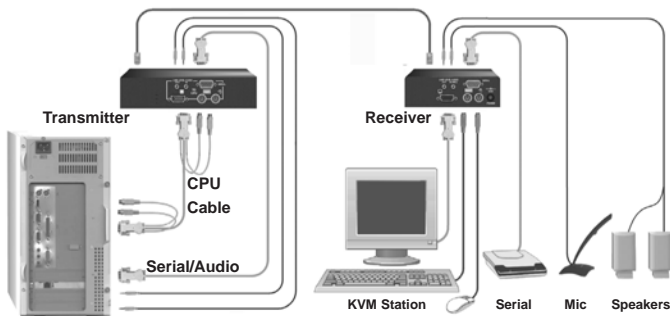

Figure 3. Cabling

Transmitter unit to host PC cabling

Refer to Figure 1 and Figure 3.

The keyboard, video, and mouse ports on the host PC are connected to the keyboard, video, and mouse ports on the SK-KVM-XXX-NR plus using an appropriate host PC adapter cable.

Transmitter KVM access models

Using models with transmitter KVM access, a second KVM operator workstation can be connected to the transmitter unit. The KVM operator workstation's keyboard, video monitor, and mouse cables can generally be connected directly to the transmitter access keyboard, monitor, and mouse ports on the transmitter unit.

Receiver unit to KVM operator workstation cabling

Refer to Figure 2 and Figure 3.

On the receiver unit, the KVM operator workstation's keyboard, monitor, and mouse cables are connected directly to the SK-KVM-XXX-NR keyboard, monitor, and mouse connectors.

Receiver unit to KVM operator workstation cabling

On the receiver unit, the KVM operator workstation's keyboard, monitor, and mouse cables are connected directly to the SK-KVM-XXX-NR keyboard, monitor, and mouse connectors. Connect a second monitor to view the second video source.

Division 2 mounting bracket

Mounting brackets are required for mounting Division 2 locations. The brackets include plates that hold the cables so that they remain securely attached. Mounting clips are also included for DIN rail attachment.

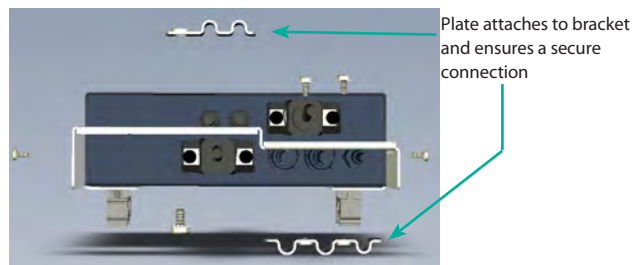
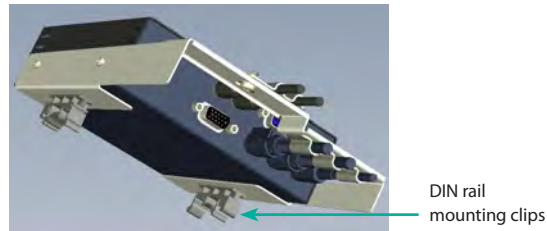
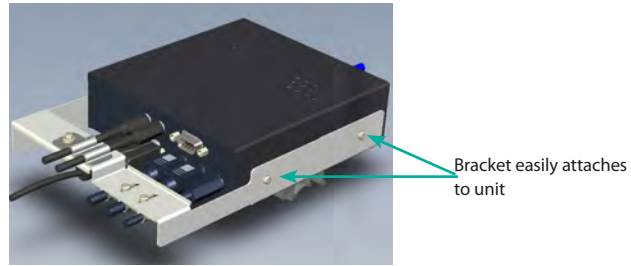

Figure 4. Div.2 mounting bracket

The bracket attaches easily to the units. First, remove the round rubber feet from the bottom of the unit. Then, simply remove the the screws on the side of the unit; attach DIN rail mounting clips; place the unit in the bracket frame; attach the frame to the unit using the same screws.

Applying power

Transmitter: The transmitter unit gets its power from the keyboard port of the host PC. Connect the transmitter to the host PC with the appropriate PS2 cable.

Receiver: The receiver unit must be supplied by an ITE Listed external power supply marked either "Class 2" or "LPS" that is suitable for use in Class I, Division 2, Groups A, B, C, and D hazardous locations.

NOTE: An isolated power supply must be used to ensure proper operation. Failure to use an isolated power supply could result in damage or failure to the KVM extender. This type of fault is not covered by the warranty.



Keyboard commands

Video adjustments

Video adjustments are performed from the receiver unit using simple keyboard commands. The following table shows the keyboard commands and key sequences used to initiate the command.

NOTE: Use only the numeric keys above the keyboard to initiate keyboard commands from the receiver unit. Do not use the numeric keypad.

Command	Key Sequence
Command mode	[L-Ctrl] + [L-Shift] + [F10]
Exit Command mode and save	[ESC]
Exit Command mode without saving	[L-Shift] + [ESC]
Select channel 1, 2, 3, or 4	[1] / [2] / [3] / [4]
Select channel 0	[0] (select all channels)
Reset EQ & delay values	[L-Ctrl] + [Home]
Next assisted EQ setting	[L-Ctrl] + [PgUp]
Previous assisted EQ setting	[L-Ctrl] + [PgDn]
Increase RED delay	[R] + [R-arrow]
Decrease RED delay	[R] + [L-arrow]
Increase Green delay	[G] + [R-arrow]
Decrease Green delay	[G] + [L-arrow]
Increase Blue delay	[B] + [R-arrow]
Decrease Blue delay	[B] + [L-arrow]
Toggle RED delay	[L-Ctrl] + [R]
Toggle GREEN delay	[L-Ctrl] + [G]
Toggle BLUE delay	[L-Ctrl] + [B]
Reset EQ values	[L-Ctrl] + [End]
Increase LF EQ (Course)	[L] + [Up Arrow]
Decrease LF EQ (Course)	[L] + [Dn Arrow]
Increase LF EQ (Fine)	[L] + [R-Arrow]
Decrease LF EQ (Fine)	[L] + [L-Arrow]
Increase HF EQ (Course)	[H] + [Up Arrow]
Decrease HF EQ (Course)	[H] + [Dn Arrow]
Increase HF EQ (Fine)	[H] + [R-Arrow]
Decrease HF EQ (Fine)	[H] + [L-Arrow]
Reset keyboard and mouse	[F1]
Send NULL mouse byte	[F3]
Reset to factory defaults	[L-Ctrl] + [F9]
Toggle Unit Private Mode	[Scroll Lock]

NOTE: All keyboard commands are initiated from the receiver unit. Before any keyboard command can be issued, the unit must be in the command mode and a channel selected.

Keyboard command descriptions

Command mode – [L-Ctrl] + [L-Shift] + [F10]

Entering the command mode sends the receiver units keyboard instructions to the SK-KVM-XXX-NR instead of the connected computer. In the command mode, the yellow LED on the receiver unit's RJ45 connector for channel 1 will light indicating that the unit is in the command mode. The keyboard status LEDs (Num lock, Caps Lock, and Scroll Lock) will flash indicating which channel is selected. The Command mode automatically times out after 30 seconds of inactivity, saves all settings, and returns the keyboard to normal functions.

No. of keyboard status LED flashes	Video channel selected
1	Channel 1 (default, all models)

Exit Command mode and save – [Esc]

Pressing the Esc key while in the command mode will save all configuration changes made and exit the command mode.

Exit Command mode without saving – [L-Shift] + [Esc]

Pressing the left shift key and the Esc key while in the command mode will exit the command mode without saving any configuration changes.

Select Channel 1 – [1]

Pressing 1 while in the command mode selects channel one and all configuration adjustments apply to channel 1 only. Keyboard status LEDs flash once.

Reset EQ & Delay values – [L-Ctrl] + [Home]

Issuing this command resets the LF and HF equalization and the red, green, and blue delay values for the selected channel.

Next Assisted EQ setting – [L-Ctrl] + [PgUp]

This command resets the LF and HF equalization settings, then each time the command is issued, incrementally steps through a table of preset LF and HF equalization values for different cable lengths in 25 m increments from 0 to 375 m. After finding the best setting, fine tuning of the HF and LF equalization may be needed. Perform the fine tuning after adjusting for any color skew.

Previous Assisted EQ setting – [L-Ctrl] + [PgDn]

This command decreases the LF and HF equalization settings by 25 m. Use this command in conjunction with the Next Assisted EQ setting command to obtain the best setting for the select channel.

Increase RED delay – [R] + [R-Arrow]

Each time this command is issued, the RED video component is delayed an incremental step from 0 to 42 ns max. in 2.8 ns steps.

Decrease RED delay – [R] + [L-Arrow]

Use this command along with the increase RED delay to properly align the RED video component.

Increase GREEN delay – [G] + [R-Arrow]

Each time this command is issued, the GREEN video component is delayed an incremental step from 0 to 42 ns max. in 2.8 ns steps.

Decrease GREEN delay – [G] + [L-Arrow]

Use this command along with the increase GREEN delay to properly align the GREEN video component.

Increase BLUE delay – [B] + [R-Arrow]

Each time this command is issued, the BLUE video component is delayed an incremental step from 0 to 42 ns max. in 2.8 ns steps.

Decrease BLUE delay – [B] + [L-Arrow]

Use this command along with the increase BLUE delay to properly align the BLUE video component.

Toggle RED delay – [L-Ctrl] + [R]

Each time this command is issued, the RED video component delay is toggled between 0 and 19 ns.

Toggle GREEN delay – [L-Ctrl] + [G]

Each time this command is issued, the GREEN video component delay is toggled between 0 and 19 ns.

Toggle BLUE delay – [L-Ctrl] + [B]

Each time this command is issued, the BLUE video component delay is toggled between 0 and 19 ns.

(Refer to Figure 7 for LF and HF adjustments)

Reset EQ values – [L-Ctrl] + [End]

Issuing this command will reset the HF and LF equalization values for the selected video channel to zero. Color delay values are not affected.

Increase LF EQ (Course) – [L] + [Up Arrow]

Use the Increase LF EQ adjustment to remove black smears to the right of large objects.

Decrease LF EQ (Course) – [L] + [Dn Arrow]

Use the Decrease LF EQ adjustment along with the Increase LF EQ to obtain the sharpest image.

Increase LF EQ (Fine) – [L] + [R-Arrow]

Use the Increase LF EQ adjustment to remove black smears to the right of large objects.

Decrease LF EQ (Fine) – [L] + [L-Arrow]

Use the Decrease LF EQ adjustment along with the Increase LF EQ to obtain the sharpest image.

Increase HF EQ (Course) – [H] + [Up Arrow]

Use the Increase HF EQ adjustment to sharpen the image.

Decrease HF EQ (Course) – [H] + [Dn Arrow]

Use the Decrease HF EQ adjustment along with the Increase LF EQ to obtain the sharpest image.

Increase HF EQ (Fine) – [H] + [R-Arrow]

Use the Increase HF EQ adjustment to sharpen an image.

Decrease HF EQ (Fine) – [H] + [L-Arrow]

Use the Decrease HF EQ adjustment along with the Increase LF EQ to obtain the sharpest image.

Reset keyboard and mouse – [F1]

Pressing the [F1] key while in the command mode resets the keyboard and mouse, then exits the command mode. Use this command if the keyboard or mouse lock up or the mouse does not initialize properly.

Send NULL mouse byte – [F3]

Pressing the [F3] key while in the command mode will send a NULL byte to the system and then exits the command mode. Use this command to re-synchronize an out of sync mouse. This command may need to be issued several times to re-sync the mouse.

Reset to factory defaults – [L-Ctrl] + [F9]

The reset to factory default command will reset the HF and LF equalization values, all color delay values and configurations for all channels to the original factory defaults and exit the command mode.

Toggle unit private mode – [Scroll Lock]

SK-KVM-XXX-NR models with transmitter KVM access have a private mode available which can inhibit the transmitter or receiver unit. When the transmitter or receiver unit issues this command, it blanks the monitor and prevents the other unit from being used until the private mode command is issued again. To indicate that a unit is in the private mode, the scroll lock LED will slowly flash. To cancel the private mode, enter the Command Mode and press the Scroll Lock key again.

Transmitter unit keyboard commands (dual transmitter model only)

To initiate a transmitter unit keyboard command, first press the "HOT-KEY" then the command. The default "HOT-KEY" is the right control key. To change the default "HOT-KEY" from the right control key to the left control key, enter the Command mode and press [F7]. This toggles the "HOT-KEY" from the right control key to the left control key. When the [F7] key is pressed, the "HOT-KEY" change is saved and the unit exits the Command mode and returns to normal operation.

The transmitter user can start a private session by pressing the "HOT-KEY" (right control key), then the scroll lock key. When the transmitter unit is in the private mode, the Scroll Lock LED on the transmitter unit flashes and all three LEDs on the receiver unit will illuminate. The receiver monitor is blanked and the keyboard and mouse are disabled.

Reset the transmitter keyboard and mouse

If the transmitter keyboard or mouse locks up, you can reset them by issuing the reset command. Press the "HOT-KEY", then [Num Pad Left Arrow] (generally the "4" key on the numeric keypad)

Send NULL mouse byte

If there is erratic movement of the mouse pointer, issue the NULL mouse byte command. This sends a null mouse byte to the system and exits the command mode. Some operating system's mouse drivers may automatically re-synchronize the mouse signal if there is no mouse activity for a few seconds.

Adjusting the video

All video adjustments are performed from the receiver unit. Make sure all connections are in place and the video from the computer(s) connected to the transmitter unit are powered up and operating properly.

A test card has been developed for assisting in the video skew and color delay adjustments. If possible, display this test card on the receiver unit to adjust. The card can be found on the Installation and Operation Manual CD.

If displaying the test card is not possible, display some text in a large font on a white background. Also open a windows application and check the text in the tool bars and icons on the desktop for clarity and correct colors.

The RED, GREEN, and BLUE delay for a selected channel can be adjusted to obtain the clearest image. If possible, use the on-line test card to perform the skew adjustments. (See Figure 5.)

First enter the Command mode ([L-Ctrl] + [L-Shift] + [F10]) then select a channel to adjust [1, 2, 3, 4, or 0] and then display the test card. The color skew adjustment lines on the test card are equally divided into RED, GREEN, and BLUE. If the colors on the line are not aligned, adjust the skew by increasing the color delay for the faster color(s). Refer to the example in Figure 5.



Figure 5. Color skew delay compensation

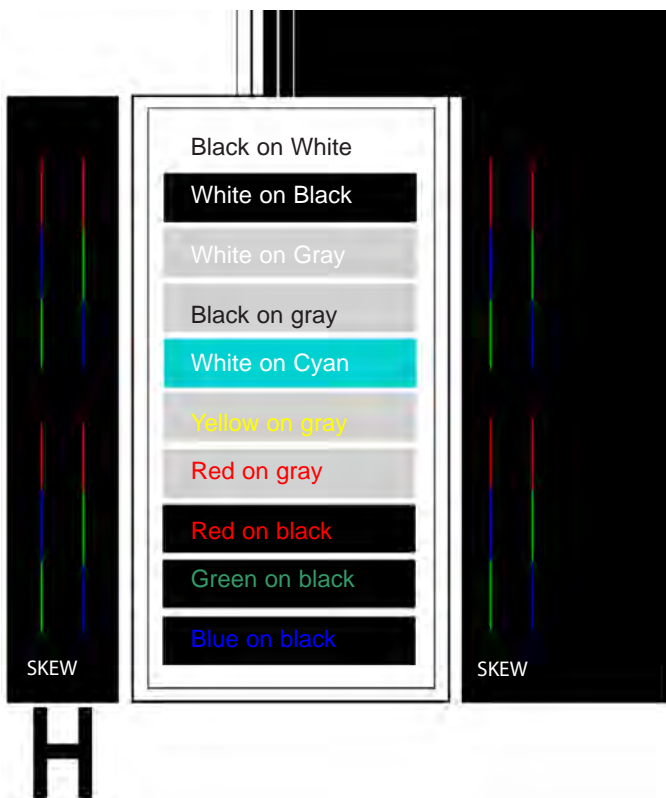

Figure 6. Video test card

To begin adjusting the LF and HF equalization, display the text card as shown in Figure 5. Observe the "H" in the lower left corner of the test card. Compare it with the example shown in Figure 6 and adjust the LF or HF equalization to obtain sharp clean image edges.

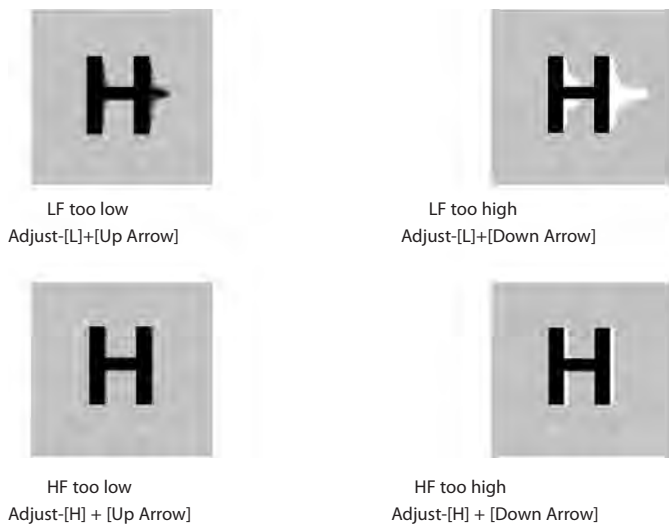

Figure 7. HF / LF adjustment guide

In summary, adjusting the video consists of:

- Enter the Command Mode
- Select the video channel to adjust
- Display the test card or a created straight line graphic that is equally divided into three color parts, RED, GREEN, and BLUE
- Adjust the RED, GREEN, and BLUE delay to align the three colors Observe the "H" in the lower left corner of the test card or display some text on a white background.
- Adjust LF and HF Equalization to eliminate smearing or bright streaks
- Save the settings
- On the dual and quad models, select the next video channel to adjust and perform steps 3 – 7 on this and all other channels.

When you enter the "Command Mode" to adjust a channel's video, the yellow LED on the Rj45 connector for channel one will light (not blink). When you are adjusting the video, keyboard commands are directed to the SK-KVM-XXX-NR receiver unit. Mouse activity is temporarily halted until you exit the command mode. When you select a channel to adjust the video, the status LEDs on the keyboard will blink, indicating which channel is selected. (See Table 2.)

Operating instructions

Once the receiver and transmitter units are connected and configured, the receiver KVM operator workstation's keyboard, video monitor and mouse will function as if it were directly connected to the host PC. All applications, upgrades and PC configurations can be performed normally.

Each RJ45 connector on the receiver unit has two LEDs. The left LED is yellow, the right one is green. The green LED on all channels will flash if a video signal is being received from the transmitter unit. If no video signal is being received, the green LED will remain "ON." The yellow LED on channel one only will flash indicating that the keyboard and mouse are active.

Product specifications

Maximum resolution	1600 x 1200 @ 60 Hz Less than 650 feet / 200M) 1280 x 1024 @ 75 Hz 650 -1,000 feet / 200 – 300M)
Video compatibility	VGA to UXGA, RGB
Video levels	0.7V P-P
Video coupling	DC
Sync type	Separate/composite TTL level Sync on green Sync polarity is preserved.
Keyboard	PC/AT, PS/2
Skew adjustment	2.8 ns steps / 42 ns max per color
Mouse	Standard PS/2 two/three button Standard wheel mice Logitech 3-button PS/2
Serial data	Format: Transparent Signals: TX, RX, RTS, CTS, DTR, DSR Baud rate: 19.2K max
Audio data	Digitized, bi-directional stereo audio Input level: 4.0 V P-P Input impedance: 47K ohms
Transmitter power	From PC keyboard port
Receiver power	12 V, 10 W regulated (auto-sensing 100 – 240 VAC input)
Connectors	Video to PC – HD15M Video to KVM – HD15F Keyboard / mouse: MiniDin-6 Serial: Transmitter unit – DB9F (DCE) Receiver unit – DB9M (DTE) Audio – 3.5 mm stereo audio jacks Interconnect: CAT-5, 5e, 6
Temp/Humidity	32 °F-104 °F / 0 °C-40 °C / 5% to 90% RH

Troubleshooting

The troubleshooting section is used as a guide to understanding the capabilities of the and for general troubleshooting. If you have any problems or questions concerning the installation, operation or usage of the SK-KVM-XXX-NR that is not covered in this manual, please contact Pepperl+Fuchs for technical support.

Image is not sharp / smeared

- Improper video equalization adjustment.
- Check CATx cable connections.
- If you are using an LCD panel, adjust the panel's clock and phase.

Separated colors / colored borders on text and icons

- Improper skew settings, adjust color delays.
- Check CATx cable connections.

No video on receiver monitor

- No power applied to transmitter unit.
- Check keyboard connection on transmitter unit, local unit power is obtained from the host PC keyboard connection.
- host PC's keyboard port does not supply adequate power for the local unit. Use an external 5 V power adapter.

Monitor goes blank for a few seconds

- Check CATx cable routing to assure it is not routed near power lines or other power sources that can cause interference.
- Check the system grounding.

Incorrect graphic mode on boot-up

- If the host PC's graphic card supports VESA DDC, configure the graphic driver for the exact make and model of the video monitor. KVM does not support Plug-and-Play (DDC) monitor selections.

Video is unstable / excess jitter

- If you are using an LCD panel, adjust the panel's clock and phase.
- Power off and on the receiver unit.

Only video is required, but no picture appears

- The probable cause is that power to the local unit is not applied. The local unit obtains its power from the host PC's keyboard port. A keyboard cable must be connected from the local unit to the host PC even if no keyboard is required. A supplementary power supply can be obtained that connects to the local units keyboard connector.

System does not detect a PS/2 mouse

- Keyboard and mouse cables reversed on the local unit.
- Cable is loose; re-seat mouse cable on the host PC and the local unit.
- Ensure that the keyboard cable to the local unit is connected to provide adequate power to the local unit.
- If you are connecting the local unit to a host PC with power applied, connect the mouse cable to the host PC before you connect the keyboard cable to ensure the mouse is correctly detected.
- Re-boot PC.



Keyboard error on boot-up

- Press [F1] or [Esc] and if this corrects the problem, modify the BIOS setting to disable keyboard testing during boot-up.

No sound at the receiver units speakers or headphones

- Audio cable loose or defective.
- Audio cable in the wrong connector.
- Sound card "Line Out" muted.

No sound at the host PC's speakers when using a microphone on the receiver unit

- Microphone cable in wrong connector.
- Sound card "MIC" input muted.
- Microphone signal not amplified; increase sound card amplification by +20db. Add "MIC" jumper on the receiver units daughter board to increase signal. Do not add this jumper if the microphone is already a powered microphone.

Serial device does not function

- Serial cable loose or defective.
- Flow control incorrectly set on unit or host PC.
- Connect serial device directly to the host PC's serial port and check to determine if the problem is a PC or KVM problem.



Transmitter front



Transmitter back



Receiver front



Receiver back



Single video models

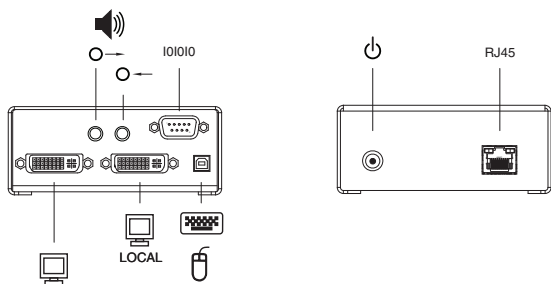

Figure 8. Transmitter

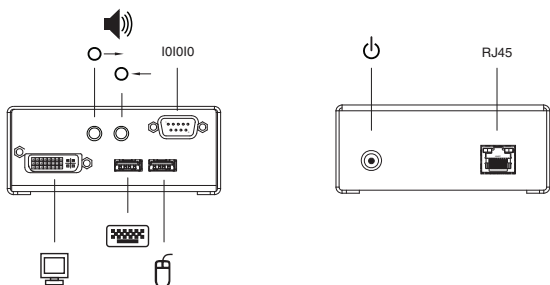

Figure 9. Receiver

Connectors	
Front	
RJ45	CATx cable connection (front panel)
Power	5 VDC power adaptor connector
Rear local single with serial/audio	
DVI-D	KVM video connection
USB(2)	Type A receiver/ (1) Type B
DB9M	Serial connector

Cables

Transmitter unit to host PC cable

host PC cables connect from the transmitter to a host PC's keyboard, video monitor and mouse ports.

Transmitter/receiver to KVM operator workstation cable

The keyboard, video monitor, and mouse cables on a KVM operator workstation can connect directly to the receiver or transmitter KVM ports.

Transmitter unit to receiver unit cable

The transmitter is connected to the receiver with up to 450 feet of CATx cable (CAT5, 5e, 6, or 7).

Serial cables

The transmitter's serial feature is incorporated in the DVI connector and is connected to the computer's serial connector (DB9M) using a DVI to DVI/DB9F cable.

A serial device connects directly to the receiver's DB9M connector.

Audio cables

The transmitter audio in/out features are incorporated in the DVI connector and connects to a computers speaker and microphone ports using a DVI to 3.5mm stereo cable. Stereo speakers and a microphone connect directly to the receivers audio input/output ports.

Installation

Please refer to the safety section first before proceeding with any installation or configuration of the SK-KVM-XXX-CW DVI CATX.

When installing SK-KVM-XXX-CW DVI CATX, locate the transmitter as close as possible to the host PC or switch. Keep the cables as short as possible but still give some freedom of movement. Using shorter cables keeps the video noise to a minimum and reduces installation costs. When mounting the units in a rack provide adequate air circulation to assure that the maximum operating temperature is not exceeded.

Wherever the transmitter and receiver units are located, they should be on a secure surface and free from obstructions and objects that may cause damage to the units.

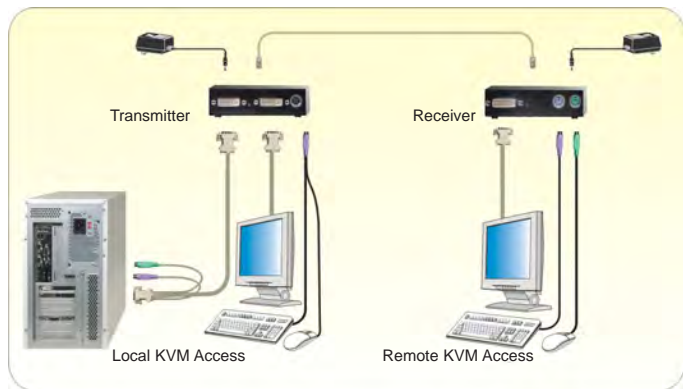

Figure 10. Typical cabling configurations

(See Figure 8 for the connector locations for your model.)

NOTE: Transmitter access provides for a second KVM operator workstation connected to the transmitter. Damage to the unit can occur if the DVI connectors are connected incorrectly. Make sure the DVI connector to the computer is NOT connected to a DVI monitor. The serial and audio transmitter connects to the computers serial and audio ports (Line in / Microphone).

Division 2 mounting bracket

Mounting brackets are required for mounting Division 2 locations. The brackets include plates that hold the cables so that they remain securely attached. Mounting clips are also included for DIN rail attachment.

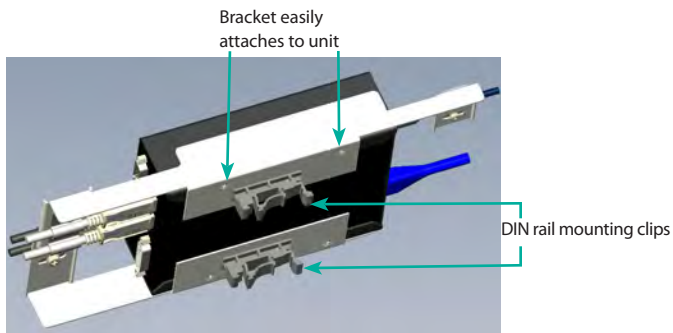
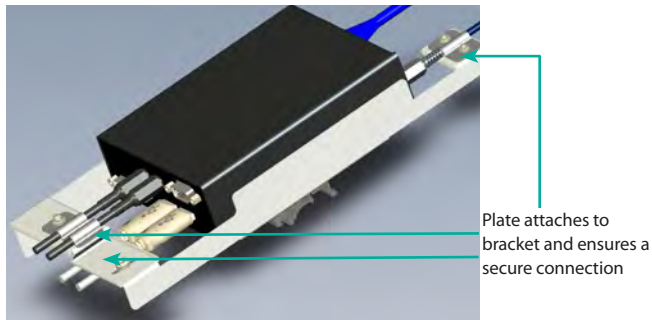

Figure 11. Div. 2 mounting bracket

The bracket attaches easily to the units. First, remove the round rubber feet from the bottom of the unit. Then, simply remove the screws on the bottom of the bracket frame; attach DIN rail mounting clips; place the unit in the bracket frame; attach the frame to the unit using the same screws.

Transmitter to receiver cabling

Cable type	Maximum distance
CAT5, 5e, 6, or 7	450 ft / 140 m

Applying power

Transmitter: With all cable connections made, plug in the provided power adapters to a 110/220-volt source and to the power connector on the transmitter. Only use the power adapter provided for the transmitter. The red LED next to the power connector indicates power is applied to the unit.

Receiver: The receiver unit must be supplied by an ITE Listed external power supply marked either "Class 2" or "LPS" that is suitable for use in Class I, Division 2, Groups A, B, C and D Hazardous Locations.

NOTE: An isolated power supply must be used to ensure proper operation. Failure to use an isolated power supply could result in damage or failure to the KVM extender. This type of fault is not covered by the warranty.

LED indicators

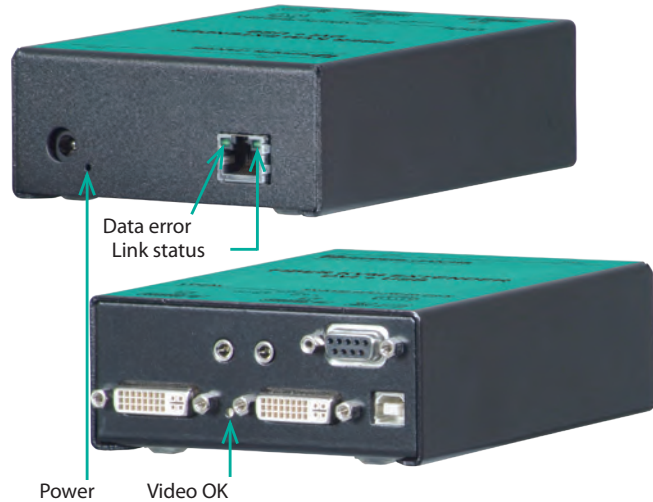

Figure 12. LEDs

Power (Red)

- Off - No power applied, device not ready
- On - Power applied, device ready

Data Error (Green)

- Off - No errors, device ready
- Blinking / On - Transmitter / Receiver communication not established, cable too long, attenuation too high, excess EMI interference

Link Status (Green)

- Blinking - No CATx cable connection detected
- On - transmitter / receiver communication established, device ready

Video OK (Green)

- Off - No video signal detected
- On - Video signal detected, device ready

NOTE: The USB models only support USB keyboards and mice. Other USB devices such as touch screen, graphic tablets, barcode readers or similar devices are supported but not guaranteed. Scanners, web cams, USB drives, etc are not supported. The KVM (USB models) will only support two USB devices at the same time.

Operating instructions-local KVM access

Operation of your computer is no different than having your keyboard, monitor, and mouse connected directly to the computer. All functions, applications, upgrades and other items can be done normally. The only difference is the computer can be up to 450 feet away.

SK-KVM-XXX-CW DVI CATx with local KVM access allows an additional KVM operator workstation to be connected to the transmitter. The host PC can easily be operated from the receiver KVM operator workstation or the local KVM operator workstation but not simultaneously.

The transmitter or local unit is active during boot-up and the connected host PC's video is displayed on both the local and receiver KVM operator workstations monitor. To activate the receiver KVM operator workstation, simply press any key on the receiver KVM operator workstations keyboard. Control is passed to the receiver KVM operator workstation. To activate the local KVM operator workstation, press any key on the KVM operator workstation's keyboard.

The dual video models have the capability of connecting the transmitter to two video sources. The two video sources are sent to the receiver and displayed on its two video monitors. Video source one should be connected to the computer's primary DVI video port that is associated with the keyboard and mouse.

DDC information

By default, the SK-KVM-XXX-CW DVI CATx uses its own internal DDC table. In some configurations it may be necessary to redefine the source of the DDC information. The SK-KVM-XXX-CW DVI CATx can use the internal DDC table, the DDC information from the local video, or download the DDC information from the receiver video monitor. Adjustments are made on the local unit to use the default DDC information, the LOCAL monitor's DDC information, or the REMOTE monitor's DDC information. For more information on this, please contact Pepperl+Fuchs technical support.

Product specifications

Maximum resolution	DVI – 1920 x 1200 @ 60Hz
Video compatibility	DVI-D
Keyboard	USB
Mouse	USB
Transmitter power	90-240 VAC adapter to 5VDC / app. 10W
Receiver power	90-240 VAC adapter to 5VDC / app. 10w
Connectors	Video to PC – DVI-I Video to KVM – DVI-I Keyboard: USB Mouse: USB Interconnect: RJ45
Temp/Humidity	0 °C-50 °C / 80% RH max
Weight	0.65 lbs / 0.3 kg (each unit)
Dimensions	H: 1.375 in / 3.0 cm W: 4.125 in / 10.0 cm D: 5.625in / 14.4 cm

Troubleshooting

The troubleshooting section is used as a guide to understanding the capabilities of the SK-KVM-XXX-CW DVI CATx and for general troubleshooting. If you have any problems or questions concerning the installation, operation or usage of the SK-KVM-XXX-CW DVI CATx that is not covered in this manual, please contact Pepperl+Fuchs for technical support.

There isn't a picture

- Check the power supply connection at the local unit. Is the Power (Red LED) at the local unit illuminated? If not, the internal power-supply may be damaged or there may be an internal error.
- Check the power supply connection at the receiver unit. Is the Power (Red LED) at the receiver unit illuminated? If not, the internal power-supply may be damaged or there may be an internal error.
- Check that the Interconnection cable is connected at the local unit and the receiver unit. Is the Link Status LED illuminated? If not, there may be a problem with the Interconnection cable.
- Are there errors through data transmission over CATx cable (cable too long, too high attenuation, or too much EMI interferences)? Is the Data Error LED illuminated or blinking? If yes, check cable length and environment.
- Video Okay LED is dark: host PC does not provide a video signal. Check graphic card settings. Try connecting a monitor to the local output to see if there is a signal.

Keyboard

The PC boots with no error messages but the keyboard does not work

- Wrong cable plugged in, keyboard and mouse cables reversed.
- Try a different model of keyboard. If the new keyboard works then original one may be incompatible
- Check that the Interconnection cable is connected at the local unit and the receiver unit. Is the Link Status LED illuminated?

PS2-Mouse

A mouse cursor appears on the screen, but the mouse doesn't work

- Wrong cable plugged in, keyboard and mouse cables reversed.
 - Try a different model of mouse
- The system does not detect a PS/2 mouse, or the application cannot find the mouse.
- Ensure that the local unit is connected to the PC keyboard port to provide power



Transmitter front



Transmitter back



Receiver front



Receiver back

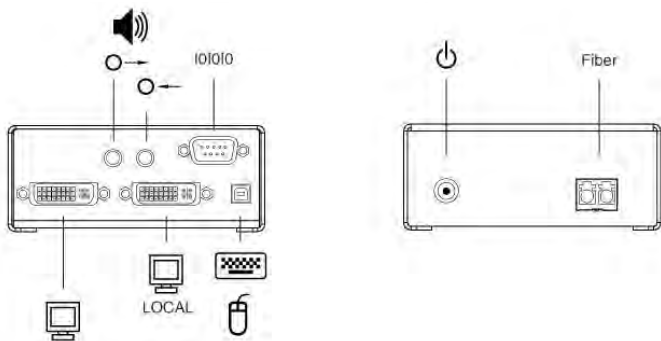

Figure 13. Transmitter

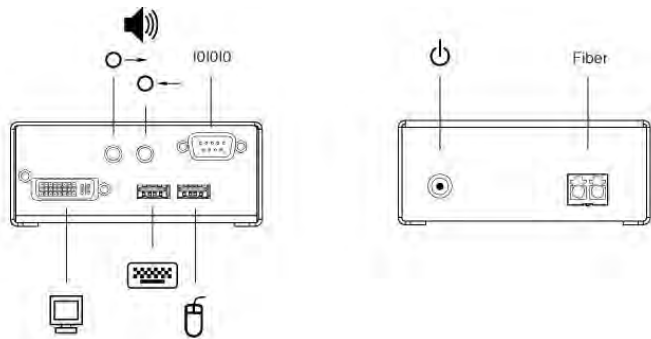

Figure 14. Receiver

Cables

*See Attachment B for cable part numbers

Transmitter unit to host PC cable

Host PC cables connect from the transmitter to a host PC's keyboard, video monitor and mouse ports. A "Y" PS/2 cable for the keyboard and mouse are needed.

Receiver to KVM operator workstation cable

The keyboard, video monitor, and mouse cables on a KVM operator workstation can connect directly to the receiver or a transmitter with local KVM access.

Transmitter unit to receiver unit cable

The transmitter is connected to the receiver with up to 1,300 feet of fiber cable.

Installation

Please refer to the safety section first before proceeding with any installation or configuration of the - SK-KVM-XXX-FW DVI Fiber.

When installing the SK-KVM-XXX-FW DVI Fiber, locate the transmitter as close as possible to the host PC or switch. Keep the cables as short as possible but still give some freedom of movement. When mounting the units in a rack provide adequate air circulation to assure that the maximum operating temperature is not exceeded.

Wherever the transmitter and receiver units are located, they should be on a secure surface and free from obstructions and objects that may cause damage to the units.

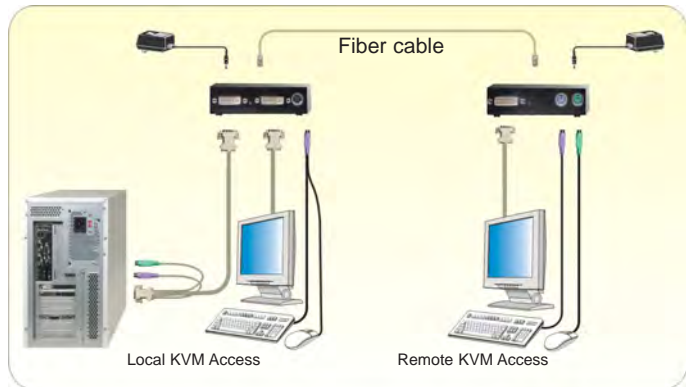

Figure 15. Typical cabling configurations

(See Figure 13 for the connector locations for your model)

NOTE: Using the local access model, a second KVM operator workstation can be connected to the transmitter.

Refer to Figure 13 for the set-up for your system application. Connect the local USB model transmitter as shown below (single or dual video). A USB hub is used for local keyboard and mouse connections to the computer.

Division 2 mounting bracket

Mounting brackets are required for mounting Division 2 locations. The brackets include plates that hold the cables so that they remain securely attached. Mounting clips are also included for DIN rail attachment.

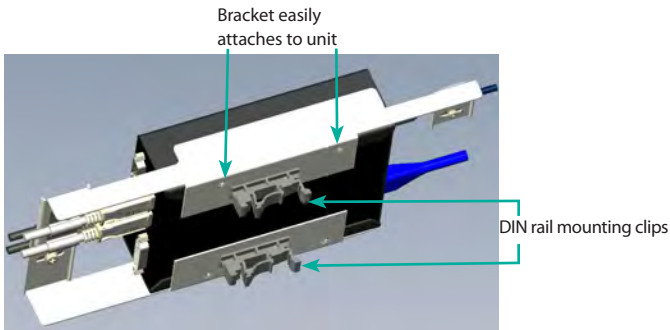
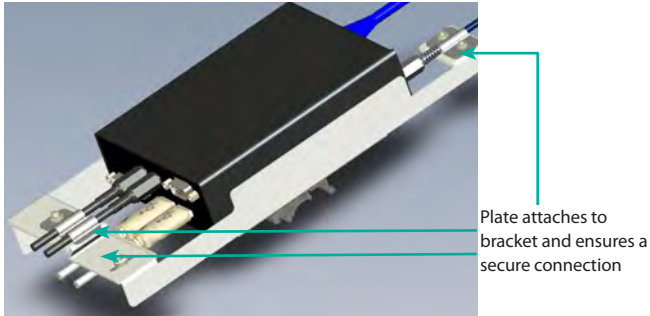

Figure 16. Div. 2 mounting bracket

The bracket attaches easily to the units. First, remove the round rubber feet from the bottom of the unit. Then, simply remove the screws on the bottom of the bracket frame; attach DIN rail mounting clips; place the unit in the bracket frame; attach the frame to the unit using the same screws.

Transmitter to receiver cabling

Cable type (w/ LC connectors)	Maximum distance
62.5 μm Multimode-Fiber	650 ft / 200 m
50.0 μm Multimode-Fiber	1300ft / 400m

Applying power

Transmitter: With all cable connections made, plug in the provided power adapters to a 110/220-volt source and to the power connector on the transmitter. Only use the power adapter provided for the transmitter. The red LED next to the power connector indicates power is applied to the unit.

Receiver: The receiver unit must be supplied by an ITE Listed external power supply marked either "Class 2" or "LPS" that is suitable for use in Class I, Division 2, Groups A, B, C and D Hazardous Locations.

NOTE: An isolated power supply must be used to ensure proper operation. Failure to use an isolated power supply could result in damage or failure to the KVM extender. This type of fault is not covered by the warranty.

Diagnostic LED indicators

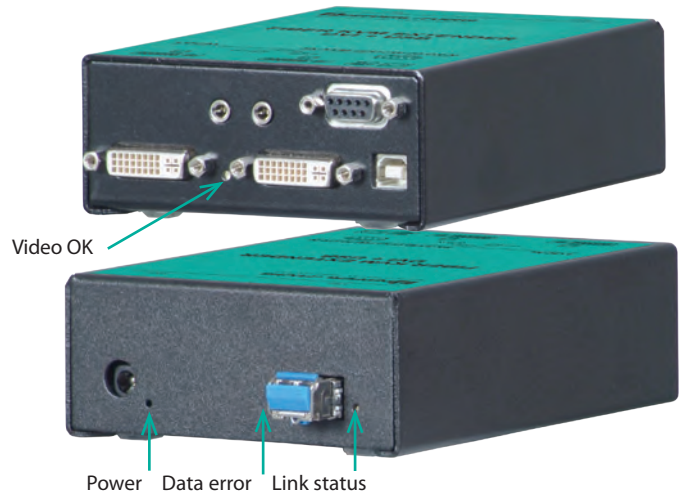

Figure 17. LEDs

Power (Red)

- Off – No power applied, device not ready
- On- Power applied, device ready

Data Error (Green)

- Off - No errors, device ready
- Blinking / On – transmitter/receiver communication not established

Link Status (Green)

- Blinking – No Fiber cable connection detected
- On – transmitter/receiver communication established, device ready

Video OK (Green)

- Off – No video signal detected
- On – Video signal detected, device ready

Operating instructions

Operation of your computer is no different than having your keyboard, monitor, and mouse connected directly to the computer. All functions, applications, upgrades and other items can be done normally. The only difference is the computer can be up to 1,300 feet away.

Transmitter access on the SK-KVM-XXX-FW DVI Fiber allows an additional KVM operator workstation to be connected to the transmitter. The host PC can easily be operated from the receiver KVM operator workstation or the local KVM operator workstation but not simultaneously.

The transmitter or local unit is active during boot-up and the connected host PC's video is displayed on both the local and receiver KVM operator workstations monitor. To activate the receiver KVM operator workstation, simply press any key on the receiver KVM operator workstations keyboard. Control is passed to the receiver KVM operator workstation. To activate the local KVM operator workstation, press any key on the KVM operator workstation's keyboard.

NOTE: The USB models only support USB keyboards and mice. Other USB devices such as Touch Screen, graphic tablets, Barcode readers or similar devices are supported but not guaranteed. Scanners, web cams, USB drives, etc are not supported. The SK-KVM-XXX-FW DVI Fiber (USB models) will only support two USB devices at the same time.

DDC information

By default, the SK-KVM-XXX-FW DVI Fiber uses its own internal DDC table. In some configurations it may be necessary to redefine the source of the DDC information. The SK-KVM-XXX-FW DVI Fiber can use the internal DDC table, the DDC information from the local video, or download the DDC information from the receiver video monitor. Adjustments are made on the local unit to use the default DDC information, the LOCAL monitor's DDC information, or the REMOTE monitor's DDC information. For more information on this, please contact Pepperl+Fuchs technical support.

Product specifications

Maximum resolution	1920 x 1200 @ 60Hz over all allowed distances all lower resolutions with refresh rates of at least 75 Hz
Video compatibility	DVI-D
Keyboard	USB
Mouse	USB
Power adapter	90-240 VAC adapter to 5 VDC / app. 10 W
Transmitter power	750 mA
Receiver power	750 mA
Connectors	Video to PC – DVI-D Video to KVM – DVI-D Keyboard: USB Mouse: USB Interconnect: Fiber type LC
Fiber cable length	62.5µm Multimode-Fiber 650 ft / 200m 50.0µm Multimode-Fiber 1300 ft / 400m
Temp/Humidity	0 °C – 50 °C / 80% non-condensing max
Indicators (LEDs)	Front panel – power Video check - LED Data error / status - LEDs
Weight	App. 1.3 lbs each (0.6 kg each)
Dimensions	H: 1.375 in / 3.0 mm W: 4.125 in / 10.0 mm D: 5.625in / 14.4 mm

Troubleshooting

The troubleshooting section is used as a guide to understanding the capabilities of the SK-KVM-XXX-FW DVI Fiber and for general troubleshooting. If you have any problems or questions concerning the installation, operation or usage of the SK-KVM-XXX-FW DVI Fiber that is not covered in this manual, please contact Pepperl+Fuchs for technical support.

There isn't a picture

- Check the power supply connection at the local unit. Is the Power (Red LED) at the local unit illuminated? If not, the internal power-supply may be damaged or there may be an internal error.
- Check the power supply connection at the receiver unit. Is the Power (Red LED) at the receiver unit illuminated? If not, the internal power-supply may be damaged or there may be an internal error.
- Check that the Interconnection cable is connected at the local unit and the receiver unit. Is the Link Status LED illuminated? If not, there may be a problem with the Interconnection cable.
- Are there Errors through data transmission over fiber Cable? Is the Data Error LED illuminated or blinking? If yes, check cable length and environment.
- Video Okay LED is dark: host PC does not provide a video signal – Check settings of the graphic card. Try connecting a monitor to the local output, to see, whether there is a signal or not.

Keyboard

The PC boots with no error messages but the keyboard doesn't work

- Wrong cable plugged in, keyboard and mouse cables reversed.
- Try a different model of keyboard. If the new keyboard works then original one may be incompatible
- Check that the Interconnection cable is connected at the local unit and the receiver unit. Is the Link Status LED illuminated?

Service information

Maintenance and repair

This unit does not contain any internal user-serviceable parts. In the event a unit needs repair or maintenance, you must first obtain a Return Authorization (RA) number from Pepperl+Fuchs, Inc. This Return Authorization number must appear on the outside of the shipping container.

See Limited Warranty for more information.

When returning a unit, it should be double-packed in the original container or equivalent, insured and shipped to:

Pepperl+Fuchs
 Attn: RA _____
 1600 Enterprise Pkwy
 Twinsburg, OH 44087 USA

Safety

The SK-KVM-XXX KVM extenders have been tested for conformance to safety regulations and requirements, and have been certified for international use. Like all electronic equipment, the SK-KVM-XXX should be used with care. To protect yourself from possible injury and to minimize the risk of damage to the unit, read and follow these safety instructions.

- Follow all instructions and warnings marked on this unit.
- Except where explained in this manual, do not attempt to service this unit yourself.
- Do not use this unit near water.
- Assure that the placement of this unit is on a stable surface or rack mounted.
- Provide proper ventilation and air circulation.
- Keep power cord and connection cables clear of obstructions that might cause damage to them.
- Use only a grounded AC source.
- Keep objects that might damage this unit and liquids that may spill, clear from this unit. Liquids and foreign objects might come in contact with voltage points that could create a risk of fire or electrical shock.
- Operate this unit only when the cover is in place.
- Do not use liquid or aerosol cleaners to clean this unit. Always unplug this unit from its electrical outlet before cleaning.
- Unplug this unit from the electrical outlet and refer servicing to a qualified service center if any of the following conditions occur:
 - The power cord or connection cables are damaged or frayed.
 - The unit has been exposed to any liquids.
 - The unit does not operate normally when all operating instructions have been followed.
 - The unit has been dropped or the case has been damaged.
 - The unit exhibits a distinct change in performance, indicating a need for service.

Safety and EMC regulatory Statements

Safety information



Documentation reference symbol. If the product is marked with this symbol, refer to the product documentation to get more information about the product.

WARNING A WARNING in the manual denotes a hazard that can cause injury or death.

CAUTION A CAUTION in the manual denotes a hazard that can damage equipment.

Do not proceed beyond a WARNING or CAUTION notice until you have understood the hazardous conditions and have taken appropriate steps.

Grounding

These are Safety Class I products and have protective earthing terminals. There must be an un-interruptible safety earth ground from the main power source to the product's input wiring terminals, power cord, or supplied power cord set. Whenever it is likely that the protection has been impaired, disconnect the power cord until the ground has been restored.

Servicing

There are no user-serviceable parts inside these products. Only service-trained personnel must perform any servicing, maintenance, or repair.

The user may adjust only items mentioned in this manual.



FCC/IC Statements, EU Declaration of Conformity

FEDERAL COMMUNICATIONS COMMISSION AND INDUSTRY CANADA RADIO-FREQUENCY INTERFERENCE STATEMENTS

This equipment generates, uses and can radiate radio frequency energy and if not installed and used properly, that is in strict accordance with the manufacturer's instructions may cause interference to radio communication. It has been tested and found to comply with the limits for a Class A digital device in accordance with the specifications of Part 15 of FCC rules, which are designed to provide reasonable protection against such interference when the equipment is operated in a commercial environment. Operation of this equipment in a residential area is likely to cause interference, in which case the user at his own expense will be required to take whatever measures may be necessary to correct the interference. Changes or modifications not expressly approved by the party responsible for compliance could void the user's authority to operate the equipment.

This digital apparatus does not exceed the Class A limits for radio noise emission from digital apparatus set out in the Radio Interference Regulation of Industry Canada.

Le présent appareil numérique n'émet pas de bruits radioélectriques dépassant les limites applicables aux appareils numériques de la classe A prescrites dans le Règlement sur le brouillage radioélectrique publié par Industrie Canada.

EUROPEAN UNION DECLARATION OF CONFORMITY ACCORDING TO COUNCIL DIRECTIVE 89/336EEC & 73/23EEC



This equipment is in conformity with the protection requirements of the following Council Directives:
The Declaration of Conformity is based upon compliance of the product with the following harmonized standards:

- | | |
|-------------------|--------------------|
| EN55022: 1998 | EN61000-4-5: 1995 |
| EN55024: 1998 | EN61000-4-6: 1996 |
| EN61000-4-2: 1995 | EN61000-4-11: 1994 |
| EN61000-4-3: 1995 | EN60950: 2000 |
| EN61000-4-4: 1995 | |

SUITABLE FOR USE IN CLASS I, DIVISION 2, GROUPS A, B, C AND D HAZARDOUS LOCATIONS, OR NONHAZARDOUS LOCATIONS ONLY.

WARNING - EXPLOSION HAZARD - DO NOT DISCONNECT EQUIPMENT WHILE THE CIRCUIT IS LIVE OR UNLESS THE AREA IS KNOWN TO BE FREE OF IGNITABLE CONCENTRATIONS.

WARNING - EXPLOSION HAZARD - SUBSTITUTION OF ANY COMPONENT MAY IMPAIR SUITABILITY FOR CLASS I, DIVISION 2.

Must be supplied by an ITE Listed external power supply marked either "Class 2" or "LPS" that is suitable for use in Class I, Division 2, Groups A, B, C and D Hazardous Locations.

For models employing the RJ45 connector, chassis must be reliably earthed.

PROCESS AUTOMATION – PROTECTING YOUR PROCESS



For over a half century, Pepperl+Fuchs has provided new concepts for the world of process automation. Our company sets standards in quality and innovative technology. We develop, produce and distribute electronic interface modules, Human-Machine Interfaces and hazardous location protection equipment on a global scale, meeting the most demanding needs of industry. Our worldwide presence, combined with flexible operating systems in our production and service organizations, enable us to offer complete individual solutions – wherever and whenever you need us. We are the recognized experts in our technologies – Pepperl+Fuchs has earned a strong reputation by supplying the world's largest process industry companies with the broadest line of proven components for a diverse range of applications.

1 Worldwide/German Headquarters
Pepperl+Fuchs GmbH
Mannheim · Germany
Tel. +49 621 776 2222
E-Mail: pa-info@de.pepperl-fuchs.com

2 Asia Pacific Headquarters
Pepperl+Fuchs PTE Ltd.
Singapore
Company Registration No. 199003130E
Tel. +65 6779 9091
E-Mail: pa-info@sg.pepperl-fuchs.com

3 Central/Western Europe &
Africa Headquarters
Pepperl+Fuchs N.V.
Schoten/Antwerp · Belgium
Tel. +32 3 6442500
E-Mail: pa-info@be.pepperl-fuchs.com

4 Middle East Headquarters
Pepperl+Fuchs M.E (FZE)
Dubai · UAE
Tel. +971 4 883 8378
E-Mail: pa-info@ae.pepperl-fuchs.com

5 North/Central America Headquarters
Pepperl+Fuchs Inc.
Twinsburg · Ohio · USA
Tel. +1 330 486 0002
E-Mail: pa-info@us.pepperl-fuchs.com

6 Northern Europe Headquarters
Pepperl+Fuchs GB Ltd.
Oldham · England
Tel. +44 161 6336431
E-Mail: pa-info@gb.pepperl-fuchs.com

7 Southern/Eastern Europe Headquarters
Pepperl+Fuchs Elcon srl
Sulbiate · Italy
Tel. +39 039 62921
E-Mail: pa-info@it.pepperl-fuchs.com

8 South America Headquarters
Pepperl+Fuchs Ltda.
São Bernado do Campo · SP · Brazil
Tel. +55 11 4339 9935
E-Mail: pa-info@br.pepperl-fuchs.com

www.pepperl-fuchs.com

 **PEPPERL+FUCHS**
PROTECTING YOUR PROCESS