

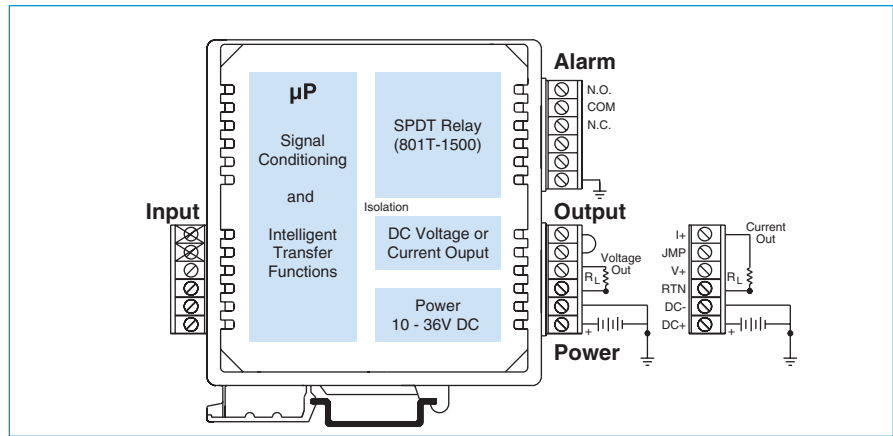

Transmitter w/alarm



801T Transmitters

Thermocouple, RTD, Millivolt, and Resistance Input

Models

801T-0500: Universal temperature transmitter
801T-1500: Transmitter with limit alarm

Input Ranges

TC types: J, K, T, R, S, E, B, N
Millivolt: $\pm 15.625\text{mV}$ to $\pm 1.0\text{V}$ DC
RTD: 100 ohm Pt, 120 ohm Ni, 10 ohm Cu
Resistance: 0 to 500 ohms

Output Ranges

0 to 1mA, 0 to 20mA, 4 to 20mA DC
0 to 5V, 0 to 10V DC

Limit Alarm

SPDT electro-mechanical relay (-1500 unit only)

Power Requirement

10 to 36V DC

Approvals

CE marked. UL, cUL listed.

Description

These transmitters isolate and convert sensor inputs to noise-free, proportional DC current or voltage output signals. An optional relay output adds a local limit alarm function.

Each unit offers a selection of input and output ranges, as well as several signal conditioning options. This flexibility enables a single IntelliPack to handle a broad range of applications. As your needs change, you can easily reconfigure the unit for different ranges or functions.

Setup is very easy. IntelliPack modules are quickly configured with the user-friendly Windows software program. Field adjustments are simple with the module's front-panel push-buttons and status LEDs. Once configured, IntelliPacks operate independent of any host computer.

Special Features

- High-resolution Sigma-Delta A/D converter delivers high accuracy with low noise.
- Advanced microcontroller provides intelligent signal processing power for linearization, averaging, and square root computations.
- Windows 95/98/ME/NT/XP/2000 software configuration speeds setup and replacement.
- Multi-purpose inputs and outputs reduce spare stock requirements.
- Relay output option provides local limit alarm capability.

Performance

General Input

Analog to Digital Converter (ADC)
16-bit Σ - Δ A/D converter.

Resolution

$\pm 0.005\%$ of span or 0.1°C .

Ambient Temperature Effect

Better than $\pm 0.005\%$ of input span per $^\circ\text{C}$ or $\pm 1\mu\text{V}$, whichever is greater.

Noise Rejection

Normal Mode: Better than 40dB @ 60Hz.
Common Mode: Better than 130dB @ 60Hz.

Input Response Time (for input step change)

Less than 200mS typical
to 98% of final output value.

Input Overvoltage Protection

Bipolar Transient Voltage Suppressors (TVS).

Thermocouple Input

Thermocouple Input Ranges

Thermocouple type user configured. Signal linearization, cold-junction compensation, and open circuit or lead break detection are included.

TC	$^\circ\text{C}$ Range ($^\circ\text{F}$ Range)	Accuracy
J	-210 to 760°C (-346 to 1400°F)	$\pm 0.5^\circ\text{C}$
K	-200 to 1372°C (-328 to 2502°F)	$\pm 0.5^\circ\text{C}$
T	-260 to 400°C (-436 to 752°F)	$\pm 0.5^\circ\text{C}$
R	-50 to 1768°C (-58 to 3214°F)	$\pm 1.0^\circ\text{C}$
S	-50 to 1768°C (-58 to 3214°F)	$\pm 1.0^\circ\text{C}$
E	-200 to 1000°C (-328 to 1832°F)	$\pm 0.5^\circ\text{C}$
B	260 to 1820°C (500 to 3308°F)	$\pm 1.0^\circ\text{C}$
N	-230 to 1300°C (-382 to 2372°F)	$\pm 1.0^\circ\text{C}$

Thermocouple Break Detection

TC sensor failure can be configured for either upscale or downscale.

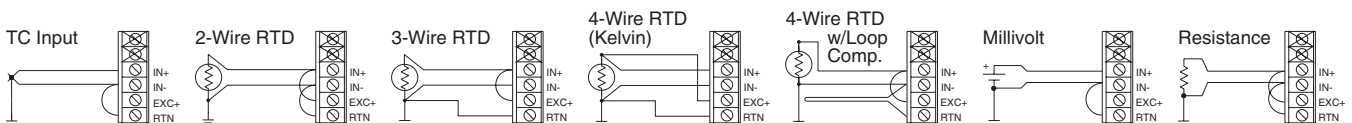



■ RTD Input

RTD Input Ranges

100 ohm Platinum, 120 ohm Nickel, or 10 ohm Copper; user-configured.

RTD	°C Range (°F Range)	Accuracy
Pt ¹	-200 to 850°C (-328 to 1562°F)	±0.25°C
Pt ²	-200 to 850°C (-328 to 1562°F)	±0.25°C
Ni	-80 to 320°C (-112 to 608°F)	±0.25°C
Cu	-200 to 260°C (-328 to 500°F)	±1.00°C

Alpha: Pt¹ ($\alpha = 1.3850$), Pt² ($\alpha = 1.3911$), Ni ($\alpha = 1.6720$), Cu ($\alpha = 1.4272$).

2, 3, or 4-wire configurations supported. Module provides sensor excitation, linearization, lead-wire compensation, and sensor break detection.

RTD Excitation Current

1mA DC typical, all types.

RTD Lead-Wire Compensation

25 ohms per lead.

RTD Break Detection

RTD sensor failure can be configured for either upscale or downscale.

■ Millivolt Input

DC Millivolt/Voltage Input Ranges

±1.0V	±125mV	±31.25mV
±500mV	±62.5mV	±15.625mV
±250mV		

Millivolt Accuracy

Better than ±0.05% of input span.

■ Resistance Input

Resistance Input Range

0 to 500 ohms.

Resistance Accuracy

±0.05 ohms.

■ Output (DC V/mA)

D/A Converter

16-bit Σ - Δ .

Current Output

Ranges: 0-1mA, 0-20mA, 4-20mA.

Compliance: 10V minimum (500 ohm load).

Accuracy: 0.025% of span.

Voltage Output

Ranges: 0-5V, 0-10V.

Compliance: 10mA maximum with short circuit protection. 1 ohm output impedance.

Accuracy: 0.025% of span.

Accuracy (overall input to output)

0.075% of span.

■ Output (Relay)

Relay

One SPDT electro-mechanical relay.

Relay Ratings (CSA ratings)

25V DC @ 5A.

120/240V AC @ 5A.

Relay Time Delay

Adjustable alarm delay of up to 25 seconds.

Contact Material

Silver-cadmium oxide (AgCdO).

Expected Mechanical Life

20 million operations.

■ Environmental

Ambient Temperature

Operating: -25 to 70°C (-13 to 158°F).

Storage: -40 to 85°C (-40 to 185°F).

Relative Humidity

5 to 95%.

Power Requirements

10 to 36V DC. 75mA @ 24V. 120mA @ 15V.

Isolation (optical)

4-way (input/output/relay/power).

1500V AC for 60 seconds or 250V AC continuous.

Radiated Field Immunity (RFI)

EN61000-4-3, EN50082-1.

Electromagnetic Field Immunity (EMI)

Less than ±0.25% of output span effect under the influence of electromagnetic fields from switching solenoids, commutator motors, and drill motors.

Electrical Fast Transient (EFT)

EN61000-4-4, EN50082-1.

Surge Withstanding Capability (SWC)

EN61000-4-5, EN50082-1.

Electrostatic Discharge (ESD)

EN61000-4-2, EN50082-1.

Radiated Emissions

EN50081-1 for Class B equipment.

Approvals

CE, UL listed (USA, Canada).

UL3121 - general product safety.

■ Configuration

Software Configuration

Units are fully programmable via the Windows 95/98/ME/2000/NT/XP IntelliPack Configuration Program. Configuration downloads from PC through EIA232 serial port using Acromag 800C-SIP kit.

Field Configuration

Output, zero/full-scale, relay setpoint and deadband are configurable via push-buttons and a standard calibrator.

LED Indicators

LEDs indicate power, status, calibration, and alarm.

■ Physical

Enclosure

Case: Self-extinguishing NYLON type 6.6 polyamide thermoplastic UL94 V-2 NEMA Type 1 enclosure.

Connectors (Removable Terminal Blocks)

Wire Range: AWG #14-22 (AWG #12 stranded only).

Printed Circuit Boards

Military grade FR-4 epoxy glass circuit board.

Dimensions

1.05W x 4.68H x 4.35D inches.

26.7W x 118.9H x 110.5D millimeters.

Shipping Weight

1 pound (0.45 Kg) packed.

■ Ordering Information

IMPORTANT: All IntelliPacks require initial software configuration (order 800C-SIP). See Note 1 below.

801T-0500

IntelliPack transmitter (TC/RTD/mV/resistance input).

801T-1500

Same as above, plus an SPDT relay output.

800C-SIP

Software Interface Package.

Only one kit is required for all IntelliPack models. See diagram on Page 47 for included parts.

5034-225

USB-to-RS232 adapter. See page 91 for more info.

PS5R-D24

Power supply (24V DC, 2.1A).

See Power Supplies on page 183.

TBK-B01

Optional terminal block kit, barrier strip style, 2 pcs. (Does not include terminal block for input wiring.)

TBK-S01

Optional terminal block kit, spring clamp style, 2 pcs. (Does not include terminal block for input wiring.)

NOTE 1: To order factory configuration, call Acromag for a configuration form which must accompany your order. Also, append "-C" to model number (example: 801T-1500-C). 800C-SIP kit is still recommended.



Optional terminal blocks: barrier strip (left) and spring clamp (right). Cage clamp terminal is standard.



Dimensions

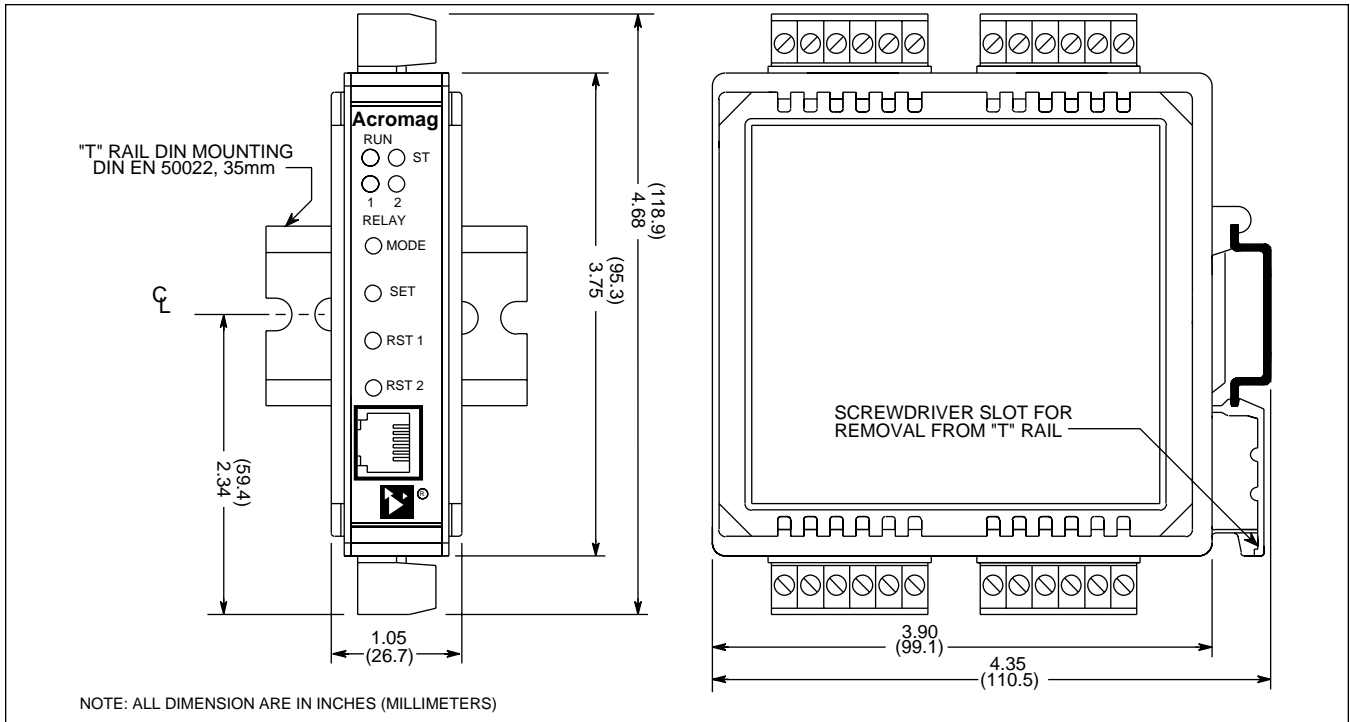



Accessories

Terminal Blocks

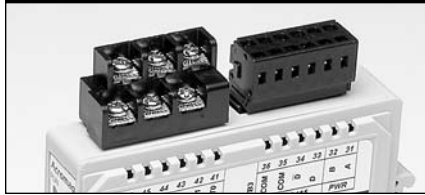

Barrier strip (left) and spring clamp (right).

Ordering Information

See individual I/O modules for compatibility.

Barrier Strip Terminal Blocks

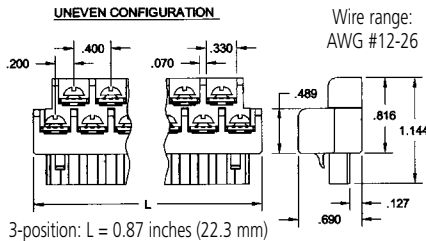
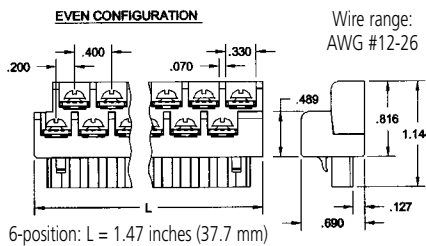

TBK-B01
Terminal block kit,
two 6-position pieces

TBK-B02
Terminal block kit,
four 6-position pieces

TBK-B03
Terminal block kit,
one 3-position and
three 6-position pieces

Spring Clamp Terminal Blocks

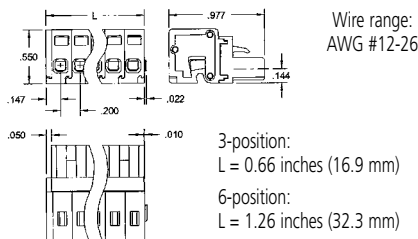

TBK-S01
Terminal block kit,
two 6-position pieces

TBK-S02
Terminal block kit,
four 6-position pieces

TBK-S03
Terminal block kit,
one 3-position and
three 6-position pieces

Mounting Hardware



DIN-Rail Mounting

For your convenience, Acromag offers several mounting accessories to simplify your system installation. Our 19" rack-mount kit provides a clean solution for mounting your I/O modules and a power supply. Or you can buy precut DIN rail strips for mounting on any flat surface.

Ordering Information

20RM-16-DIN
19" rack-mount kit with DIN rail.

DIN RAIL 3.0
DIN RAIL 16.7
DIN rail strip, Type T, 3 inches (75mm) or 16.7 inches (425mm)

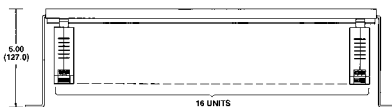
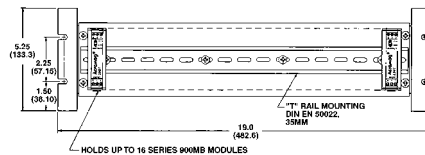

Power Supplies

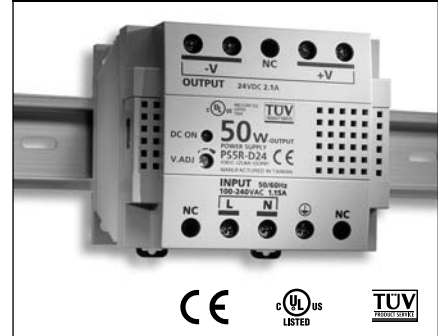

50W Supply

Input Power Requirement
85 to 264V AC or 105 to 370V DC

Output
24V DC, 2.1A (50W)

Ordering Information

PS5R-D24
Universal 50W power supply

See Power Supplies on page 183 for other models and more information.

USB / RS232 Adapter



Length: 3.15 in (8.0 cm)
Height: 0.80 in (2.03 cm)
Width: 1.75 in (4.44 cm)
Weight: 1.6 oz (45.36 g)

Ordering Information

5034-225
USB-to-RS232 adapter

AC Current Sensor

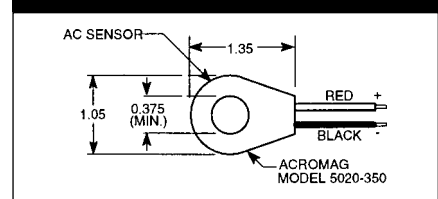

Ordering Information

5020-350
AC current sensor