

Section 7 Voltage Monitors

Voltage Monitors

Selection Guide	7.2
-----------------------	-----

3 Phase Voltage Monitors

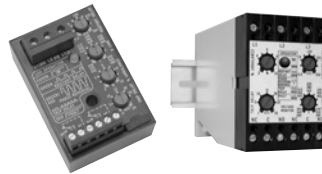

■ WVM	7.4
■ DLMU	7.6
■ HLMU	7.8
■ PLMU	7.10
■ PLM	7.12
■ TVW	7.14
■ TVM	7.16

Low Volts, Phase Reversal



■ PLR	7.18
-------------	------

Phase Reversal



■ PLS	7.20
-------------	------

DIN Rail Mounting 3 Phase Voltage Monitors



■ CM-MPS	Note: Product pages are not included in this catalog. Go to: www.ssac.com/s7.pdf Click on the Product Name (ie: CM-MPS) to open the catalog page. [Adobe Acrobat Reader is required]
■ CM-PAS	
■ CM-PSS	
■ CM-PVS	
■ CM-PFS	
■ CM-PFE	
■ CM-PVE	
■ CM-PBE	

1 Phase Voltage Monitor



■ HLV	7.22
■ KVM	7.25

DIN Rail Mounting 1 Phase Voltage Monitors













■ CM-ESS.1	see Note above
■ CM-ESS.2	see Note above
■ CM-EFS	see Note above
■ CM-ESS.M	see Note above

DIN Rail Mounting Motor Insulation Monitors



■ Selection Guide	see Note above
■ CM-MSE	see Note above
■ CM-MSS	see Note above
■ CM-MSN	see Note above

Selection Guide Voltage Monitors













For detailed product specifications, refer to catalog pages.	Three Phase						Single Phase				
											
Series	WVM 7.4	DLMU 7.6	PLM 7.12	PLMU 7.10	PLR 7.18	PLS 7.20	HLMU 7.8	TVM 7.16	TVW 7.14	HLV 7.22	KVM 7.25
Functions and Features Page	7.4	7.6	7.12	7.10	7.18	7.20	7.8	7.16	7.14	7.22	7.25
General Features											
DIN Rail Mounting	w/a	•	w/s	w/s	w/s	w/s	w/a			w/a	w/a
Surface Mounting	•	•	w/s	w/s	w/s	w/s	•	•	•	•	•
8-Pin Plug-In			•	•	•	•					
Screw Terminals	•	•					•				
Quick Connects								•	•	•	•
Output											
DPDT Relay(s)		•					•				
SPDT Relay	•		•	•	•	•		•	•	•	•
SPST-NO											
Line V Connection											
Wired Phase-to-Phase	•	•	•	•	•	•	•	•	•		
Universal Voltage		•		•			•				
Phase-to-Neutral										•	•
Single Phase										•	•
Trip Point(s) Adjustable	•	•	•	•	•		•		v		•
Trip Point(s) Fixed		•					•	•	•	•	
Supply Voltage Required											
Protection											
Phase Loss :	•	•	•	•	•		•	•	•		
Motor Operating	•	•	•	•	•		•	•	•		
Motor Start Up Only (!)					•						
Undervoltage	•	•	•	•	•		•	•	•	•	•
Oversvoltage	•	•		•			•	•	•		
Unbalance (Asymmetry)	•	•	•	•			•	•	•		
Rapid Recycling	•	•	•	•			•	•	•	•	
Phase Sequence	•	•	•	•	•	•	•	•	•		
Time Delays & Reset											
Trip Delay	•	•	•	•			•	•	•	•	
Restart Delay	•	•		•			•	•	•	•	
Automatic Restart	•	•	•	•	•	•	•	•	•	•	•
Manual Reset	•										
Indicator LED(s)											
Output ON/OFF	•	•	•	•	•		•	•	•		•
Supply ON/OFF		•	•	•			•	•	•		
Fault(s)	•	•	•	•			•	•	•		
Timing	•	•	•	•			•	•	•		
Dimensions											
	in	4.4 x 6.9 x 2.4	1.97 x 2.95 x 4.33	1.78 x 2.39 x ≤ 3.2	3 x 2 x 1.64	2.0 x 2.0 x ≤ 1.5	3 x 2 x 1.5	2 x 2 x 1.21			
	mm	111.8 x 175.3 x 61	50 x 75 x 110	45.2 x 60.7 x ≤ 81.3	76.7 x 51.3 x 41.7	50.8 x 50.8 x ≤ 38.1	76.7 x 51.3 x 38.1	50.8 x 50.8 x 30.7			

w/a = with adaptor; w/s = with socket v = Line Voltage adjustable on some models

! Phase loss protection for resistive and non-rotating loads. Motor protection can be affected by regenerated voltages.

Selection Guide Voltage Monitors

Voltage
Monitors

	Three Phase								Single Phase			
												
Series	CM-MPS	CM-PAS	CM-PVS	CM-PSS	CM-PFS	CM-PBE	CM-PFE	CM-PVE	CM-EFS	CM-ESS.2 CM-ESS.1	CM-ESS.M	
Functions and Features	Product pages are not included in this catalog. Go to: www.ssac.com/sg71.pdf . Click on the Product Name (i.e. CM-MPS)											
General Features												
DIN Rail Mounting	•	•	•	•	•	•	•	•	•	•	•	•
Surface Mounting	w/a	w/a	w/a	w/a	w/a	w/a	w/a	w/a	w/a	w/a	w/a	w/a
8-Pin Plug-In	•	•	•	•	•	•	•	•	•	•	•	•
Screw Terminals	•	•	•	•	•	•	•	•	•	•	•	•
Quick Connects												
Output												
DPDT Relay(2 SPDT)	•	•	•	•	•				•	ESS.2	•	
SPDT Relay						•	•			ESS.1		
SPST-NO						•		•				
2 SPDT (Independent)									•		•	
Normal Status	Energized	Energized	Energized	Energized	Energized	Energized	Energized	Energized	Selectable	De-energized	Selectable	
Line V Connection												
Wired Phase-to-Phase	•	•	•	380 or 400	•	•	•	•				
Universal Voltage (500VAC Max)	•	•	•		200-500		208-440					
Phase-to-Neutral	•					•		•				
Single Phase								•	24-240VAC	24-240 VAC	24-240 VAC	
Trip Point(s) Adjustable	•	•	•					•	•	ESS.2	•	
Trip Point(s) Fixed				•	•	•	•					
Supply Voltage Required								•	•	•	•	
Protection												
Phase Loss:	•	•	•	•	•	•	•	•				
Motor Operating	•	•										
Motor Start Up Only (!)			•	•	•	•	•	•				
Undervoltage	•		•	•		•		•	•	•	•	
Overvoltage	•		•	•				•	•	•	•	
Unbalance (Asymmetry)	•	•										
Voltage Window									•			
Phase Sequence	•	•	•	•	•		•					
Time Delays & Reset												
Trip Delay	•	•	•	•		•		•	•	ESS.2	•	
Restart Delay	•	h	•	•					h	h	h	
Automatic Restart	•	•	•	•	•	•	•	•	•	•	•	
Latching Output									•		•	
Indicator LED(s)												
Output ON/OFF	•	•	•	•	ON	ON	ON	ON	•	•	•	
Supply ON/OFF	•	•	•	•					•	•	•	
Fault(s)	•	•	•	•	OFF	OFF	OFF	OFF	•	•	•	
Timing	•	•	•	•					•	•	•	
Dimensions	in mm	0.89 x 3.07 x ≤ 3.98 22.5 x 78 x ≤ 101					0.89 x 3.07 x 3.09 22.5 x 78 x 78.5			0.89 x 3.07 x ≤ 3.98 22.5 x 78 x ≤ 101		

7

w/a = with adaptor; w/s = with socket; h = hysteresis

! Phase loss protection for resistive and non-rotating loads. Motor protection can be affected by regenerated voltages.

0703Ssel 12.05.06

3 Phase Voltage Monitor WVM Series Motor Protector



ANSI Device #27/47/59

- Protects Against: Phase Loss & Reversal; Over, Under & Unbalanced Voltages; Short Cycling
- 10 Fault Memory & Status Displayed on 6 LED Readout
- Switch Selectable Automatic Restart, Delayed Automatic Restart, & Manual Reset
- Isolated 10 A SPDT Relay Contacts
- ASME A17.1 rule 210.6
- NEMA MG1 14:30, 14:35
- IEEE C62.41-1991 Level B

Approvals:

Connection

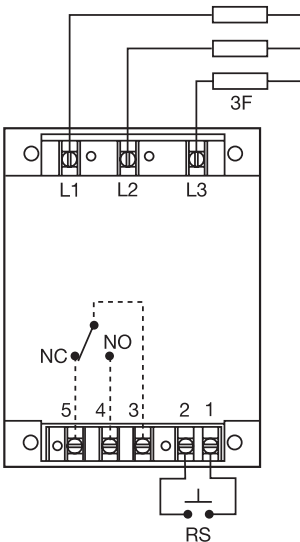

CAUTION:

2 amp max fast acting fuses must be installed externally in series with each input. (3)
Relay contacts are isolated. Dashed lines are internal connections.
F = Fuses
NO = Normally Open
NC = Normally Closed
RS = Optional Remote Reset Switch

Description

The WVM Series provides protection against premature equipment (motor) failure caused by voltage faults on the 3 Phase Line. The WVM's microcontroller design provides reliable protection even if regenerated voltages are present. It combines dependable fault sensing with a 10 fault memory and a 6 LED status display. Part instrument, part control, the WVM protects your equipment when you're not there and displays what happened when you return. The WVM is fully adjustable and includes time delays to prevent nuisance tripping and improve system operation. Time delays include a 0.25 to 30 s adjustable trip delay, an adjustable 0.25 to 64 m (in 3 ranges) restart delay, plus a unique 3 to 15 s true random start delay. The random start delay prevents voltage sags caused by simultaneous restarting of numerous motor loads after a power outage.

Operation

The output relay is energized when all conditions are acceptable and the WVM is reset. A restart and/or random start delay may occur before the output relay is energized.

Field Adjustment: Select the line voltage listed on the motor's name plate. This automatically sets the over and under voltage trip points. Consult the equipment's manufacturer specifications for the correct trip delay, unbalance percentage, and restart/reset operation and restart delay. Make connection to all three line phases as shown in the connection diagram. Apply power. If the relay fails to energize, view the LEDs for the cause, and correct the problem. If the phase sequence is incorrect, swap any two wires. No further adjustment should be required to achieve maximum equipment protection.

Read Memory: Fault(s) stored in the memory are indicated when the yellow LED is flashing. To read memory, rotate selector from Manual to Read Memory. The last fault will be displayed. Repeat this operation to read the second to the last fault. Repeat until up to 10 faults are noted.

Memory Reset: To clear the memory of all faults stored, rotate selector to Clear Memory for 5 seconds. The yellow LED will turn off.

Memory Overload: The 11th fault causes the first to be removed from memory. Only the 10 most recent faults are retained.

Random Start Delay: A new 3 to 15 s random start delay is selected by the microcontroller when a fault is corrected and when the operating voltage (L1, L2, L3) is applied to the WVM. A random start delay does not occur when the reset is manual.

Automatic Restart: Upon fault correction, the output will re-energize after a random start delay.

Automatic Restart Upon Fault Trip: When a fault is sensed for the full trip delay, the output de-energizes and a restart delay is initiated. This delay locks out the output for the delay period. Should the fault be corrected by the end of the restart delay, the output will re-energize after a random start delay. A restart delay will also occur when operating voltage (L1, L2, L3) is applied to the WVM.

Manual Reset: After a fault condition is corrected, the WVM can be manually reset. There are two methods; a customer supplied remote switch, or the onboard selector switch.

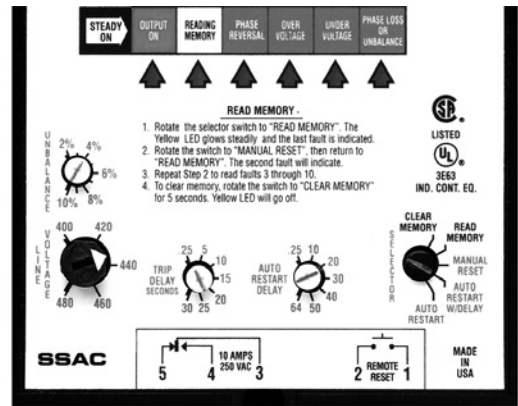

Manual Reset (Onboard): Rotate selector switch from the Manual Reset position to Auto Restart w/ Delay then back again to Manual Reset within 3 seconds. The output will immediately energize.

Remote Reset: Reset (Restart) is accomplished by a momentary contact closure across terminals 1 & 2. The output will immediately energize. Remote switch requirements are ≥ 10 mA at 20 V DC and the reset terminals are not isolated from line voltage. A resistance of $\leq 20K\Omega$ across terminals 1 & 2 will cause immediate automatic restart.

Automatic Restart Upon Fault Correction: (P/N includes an R)

When a fault is sensed for the full trip delay, the output relay de-energizes. Upon correction of the fault, a restart delay begins. At the end of this delay, the output will re-energize after a random start delay. If a fault occurs during restart timing, the restart time delay will be reset to zero, and the output will not energize until the restart delay is completed.

-60 Option: Add the suffix -60 to any automatic restart part number to remove the Random Start Delay feature. See example P/N's below.

WVM Series

X 3 Phase Line Voltage	X Unbalance	X Trip Delay	X Reset Method	X Restart Delay
-6 - 200 ... 240 V AC	-1 - 2 ... 10%	-1 - 0.25 ... 30 s	-A - Switch Selectable: Automatic Restart Upon Fault Trip	-L - 0.25 ... 64 s
-8 - 355 ... 425 V AC			-R - Switch Selectable: Automatic Restart Upon Fault Correction	-N - 6 ... 300 s
-9 - 400 ... 480 V AC				-H - 0.25 ... 64 m
-0 - 500 ... 600 V AC				

Example P/Ns: **WVM011AL**,
WVM911AL-60 (No Random Restart Delay)

3 Phase Voltage Monitor WVM Series Motor Protector

Voltage
Monitors

Technical Data

Line Voltage	3 phase Delta or Wye with no connection to neutral	
Type	Adjustment Range	
Operating Voltage	200 ... 240 V AC	
	355 ... 425 V AC	
	400 ... 480 V AC	
	500 ... 600 V AC	
Frequency	50 ... 60 Hz	
Overvoltage, Undervoltage, & Voltage Unbalance		
Overvoltage Trip Point	109 ... 113% of adjusted voltage	
Reset Voltage	-2% of trip point	
Undervoltage Trip Point	88 ... 92% of adjusted voltage	
Reset Voltage	+2% of trip point	
Voltage Unbalance	Adjustable from 2 ... 10%	
Trip Delay	Adjustable from 0.25 ... 30 s +/-15%	
Phase Loss	≥ 15% unbalance	
Response Time	≤ 200 ms	
Random Start Delay Range	3 ... 15 s	
Reset (Restart) Delay		
Low Range	0.25 ... 64 s +/-15%	
Normal Range	6 ... 300 s +/-15%	
High Range	0.25 ... 64 m +/-15%	
Fault Memory		
Type	Nonvolatile RAM	
Capacity	Stores last 10 faults	
Status Indicators	6 LEDs provide existing status & memory readout	
Note: 50% of operating line voltage must be applied to L1 & L2 for operation of status indicators		
Output		
Type	Electromechanical relay	
Form	Isolated single pole double throw (SPDT)	
Rating	10 A resistive @ 250 V AC; 6 A inductive (0.4 PF) at 250 V AC	
Protection		
Surge	IEEE 62.41-1991 Level B	
Isolation Voltage	≥ 2500 V RMS input to output	
Mechanical		
Mounting	Surface with 2 or 4 #8 (M4 x 0.7) screws	
Termination	Screw terminals with captive wire clamps for up to #12 AWG (3.2 mm ²) wire	
Environmental		
Operating/Storage Temperature	-40°C ... +65°C / -40°C ... +85°C	
Weight	≅ 25 oz (709 g)	

Reset on Balance	
Selected Unbalance %	Reset %
2	1.8
3	2.7
4	3.6
5	4.5
6	5.4
7	6.3
8	7.2
9	8.1
10	9

7

Accessories

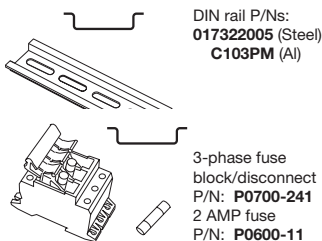

P/N: P1011-38

35mm DIN Rail Adaptor

The P1011-38 provides an easy method of mounting the WVM Series on 35mm DIN rail. The P1011-38 adaptor includes four mounting screws. 7 x 4.5 x .33 in. (177.8 x 114.3 x 8.4 mm)

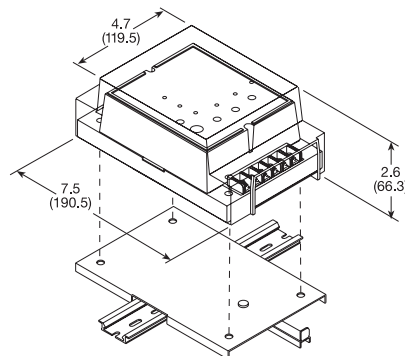

P/N: P0500-153

Inches (Millimeters)

Clear Tamperproof Cover

The P0500-153 protects against unauthorized adjustment of the trip points. It prevents the resetting of manual units by the equipment's operator. It isolates line-level connection points preventing contact during troubleshooting operations. Alignment dimples allow drilling (5 places) for limited access to adjustment knobs and the reset switch. Included are (2) spacers, (5) hole plugs. 7.5 x 4.7 x 2.6 in. (190.5 x 119.4 x 66 mm)

Mechanical View

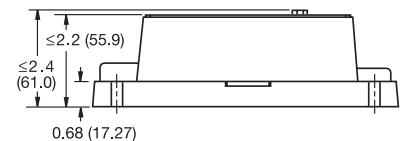
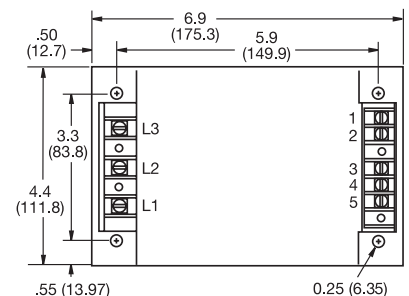

Inches (Millimeters)

WVM02B01 09-15-04

Universal 3 Phase Voltage Monitor DLMU Series (DPDT) Motor Protector



ANSI Device #27/47/59



- Protects Against: Phase Loss, Phase Reversal, Over, Under and Unbalanced Voltages, Over/Under Frequency
- 35 mm DIN Rail or Surface Mounting
- DPDT Isolated 10 A Relay Contacts
- LED Indicates, Relay, Faults, & Time Delays
- Universal Line Voltage 240 ... 480 V AC in One Unit
- 600 V AC Version Available
- 3 Wire Connection for Delta or Wye Systems
- ASME A17.1 rule 210.6
- NEMA MG1 14:30, 14:35
- IEEE C62.41-1991 Level B

Approvals:

Accessories

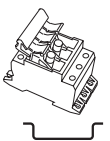

3-phase fuse block/disconnect
P/N: **P0700-241**
2 Amp Fuse
P/N: **P0600-11**

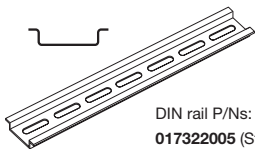

DIN rail P/Ns:
017322005 (Steel)
C103PM (Al)

See accessory pages for specifications.

Description

Preliminary Data Sheet - Available 2nd Quarter 2007

The DLMU Series is a universal voltage, 3 Phase Voltage Monitor. It continuously measures the voltage of each of the three phases with microcontroller accuracy and compares the value to preset trip points. It separately senses Phase Reversal, Over, Under and Unbalanced voltages including Phase Loss and over or under frequency. Protection is assured during periods of large average voltage fluctuations, or when regenerated voltages are present. The unit trips within 200 ms when phase loss is detected. Adjustable time delays are included to prevent nuisance tripping and short cycling of sensitive equipment. The 10A isolated DPDT output relay contacts trip when a phase voltage exceeds the trip limits for the trip delay. Nominal line voltage, voltage unbalance, and time delays are knob adjustable. The phase loss set point and the acceptable frequency range are fixed. Both Delta and Wye systems can be monitored; no connection to neutral is required.

Operation

Upon application of line voltage, the output is de-energized and the restart delay begins. If all the three phase voltages are within the acceptable range, the output energizes at the end of the restart delay. The microcontroller circuitry automatically senses the voltage range, and selects the correct operating frequency (50 or 60hz). The over and under voltage trip points are set at +/- 10% of the adjusted line voltage. When the measured value of any phase voltage exceeds the acceptable range limits (lower or upper) the trip delay begins. At the end of the trip delay the output relay de-energizes. If the phase voltage returns to an acceptable value before the trip delay expires, the trip delay is reset and the output remains energized. Under, over, and unbalanced voltages plus over or under frequency must be sensed for the complete trip delay before the unit trips. The unit trips in 200 ms when phase loss or reversal are sensed. The unit will not energize if a fault is sensed as the line voltage is applied.

Reset: Reset is automatic upon correction of the voltage or frequency fault or phase sequence.

Restart Delay Options:

L= Lockout or minimum OFF time. The restart delay begins when the output trips. The unit cannot be re-energized until the restart delay is complete. This provides a minimum off time or lockout time to allow equipment sensitive to short cycling, time to reset. If the fault is corrected after the restart delay is complete the output energizes immediately. The restart delay also occurs when line voltage is applied/reapplied.

R= Restart Delay on fault correction. The restart delay begins when line voltage is reapplied or when a voltage fault is corrected. This option is normally selected when staggered restarting of multiple motors on a power system is required.

N= No Restart Delay. 0.6 second initialization delay on application of line voltage applies.

Restart Notes:

All restart options remain reset when the following conditions are detected:

- 1.) Phase Loss (phase unbalance greater than 25%)
- 2.) Average Line Voltage less than 120VAC
- 3.) Phase Reversal

The restart delay begins when the condition is corrected.

Connection

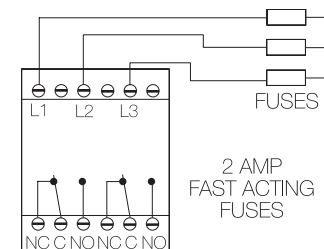

L1, L2, L3 = Line Voltage Input

NO = Normally Open Contact NC = Normally Closed Contact

C = Common, Transfer Contact

CAUTION: 2 amp max. fast acting fuses are recommended to protect the equipment's wiring. They are not required to protect the DLMU.

LED Operation

The LED flashes green during the restart delay, then glows green when the output energizes. It flashes red during the trip delay then glows red when the output de-energizes. It flashes red/green if phase reversal is sensed. If a fault is sensed during the restart delay, the LED will glow red during that portion or the full restart delay.

LED Flashing Table

Trip Delay	Red	ON/OFF	120 FPM
Restart Delay	Green	ON/OFF	60 FPM
Phase Reversal	Red/Green	Alternate	120 FPM
FPM = Flashes per minute			

Ordering Table

Series	Line Voltage	Output	Restart Function	Voltage Unbalance	Trip Delay	Restart Delay
DLM	X	X	X	X	X	X
	U - 200 ... 480 V AC H - 500 ... 600 V AC	D - DPDT	L - Lockout, Min Off Time R - Staggered Restarting N - No Restart Delay	A - Adjustable 2 ... 10% Fixed: Specify Unbalance 2...10% in 1% increments using two digits [04]	A - Adjustable 1...30s Fixed: Specify delay 1...30 s in 1 s increments, using two digits [20]	A - Adjustable 0.6 ...300 s N - No Restart Delay

Example P/N:

- DLMUDLAAA** = 200 ... 480 V, DPDT, Lockout Function Delay, Adjustable Unbalance, Trip and Restart Delay
- DLMUDRAAA** = 200 ... 480 V, DPDT, Restart Delay on fault correction, Adjustable Unbalance, Trip and Restart Delay
- DLMUDNAAN** = 200 ... 480 V, DPDT, No Restart Delay, Adjustable Unbalance and Trip Delay
- DLMUDL0420A** = 200 ... 480 V, DPDT, Lockout Function, 4% Unbalance, 20 s Trip Delay, Adjustable Restart Delay

Universal 3 Phase Voltage Monitor DLMU Series Motor Protector

Voltage
Monitors

Technical Data

Line Voltage		3 phase Delta or Wye with no connection to neutral			
Type		Range	Voltage Adjustment Range	Line Frequency	Line Voltage Max.
Operating Voltage	200 ... 480 V AC	240	200 ... 240 V AC	50 or 60 Hz	
		380	340 ... 420 V AC	50 Hz	
		480	400 ... 480 V AC	60 Hz	550 V AC
	600 V AC	600	500 ... 600 V AC	50 or 60 Hz	600 V AC
Line Frequency		50 or 60 Hz Automatically detected			
Phase Loss		≥ 25% Unbalance			
	Response Time	≤ 200ms			
Undervoltage and Voltage Unbalance		Voltage detection with delayed trip & automatic reset			
Type		109 to 113% of the adjusted line voltage			
Overvoltage:	Trip Voltage	≅ -3% of the trip voltage			
	Reset Voltage	88 ... 92% of the adjusted line voltage			
Undervoltage:	Trip Voltage	≅ +3% of the trip voltage			
	Reset Voltage	Adjustable 2 ... 10%; or specify fixed unbalance of 2 ... 10% in 1% increments			
Voltage Unbalance:	Trip Set Point	≅ -0.7% Unbalance			
	Reset on Balance	Over/Undervoltage, Voltage Unbalance, Over/Under Frequency			
Trip Delay	Active On	Adjustable from 1 ... 30 s; or specify fixed delay 1 ... 30 s in 1 s increments			
	Range	± 15%			
	Tolerance	Adjustable from 0.6 ... 300 s; if no restart delay is selected a 0.6 s initialization delay applies			
Restart Delay	Range	± 15%			
	Tolerance	± 4%; Reset ± 3%; 50 or 60 Hz			
Over/Under Frequency	Trip / Reset	A, B, C, L1, L2, L3			
Phase Sequence		≤ 200 ms			
Response Time -Phase Reversal & Phase Loss		Automatic			
Reset					
Output		Isolated Electromechanical Relay			
Type		Double pole double throw (DPDT)			
Form		10 A resistive at 240 V AC; 8 A resistive at 277 V AC; N.O-1/4 hp at 120 V AC; 1/3 hp at 240 V AC			
Rating		Mechanical -- 1 x 10 ⁶			
Life		Electrical -- (at 10 A) -- DPDT = 1 x 30 ³			
Protection		IEEE C62.41-1991 Level B			
Surge		≥ 2500 V RMS input to output			
Isolation Voltage					
Mechanical		Surface mount with 2 #8 (M4 x 0.7) screw or snap on 35mm DIN Rail			
Mounting		Note: 0.25 in.(6.35 mm) spacing between units or other devices is required			
Package		4.33 x 2.95 x 1.97 in. (110 x 75 x 50 mm)			
Termination		Screw terminals with captive wire clamps for up to #14 AWG (2.5 mm ²) wire			
Environmental		-40°C ... +60°C			
Operating Temperature		-40°C ... +85°C			
Storage Temperature		95% relative, non-condensing			
Humidity		≅ 8.6 oz (244 g)			
Weight					

7

Mechanical View

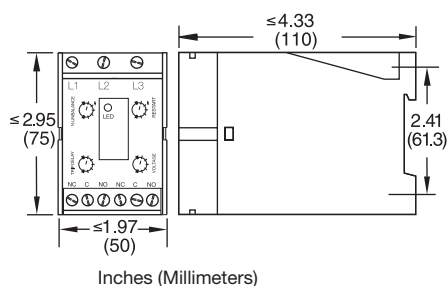

Ambient Temp {Deg. C} DLMU output rating

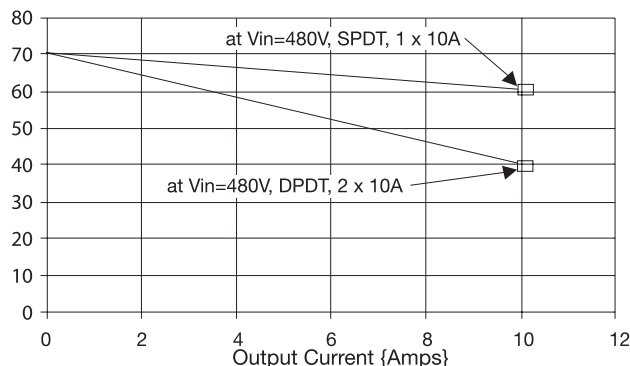

Universal 3 Phase Voltage Monitor HLMU Series (DPDT) Motor Protector



ANSI Device #27/47/59



- Protects Against: Phase Loss, Phase Reversal, Over, Under & Unbalanced Voltages, Over/Under Frequency
- Encapsulated Circuitry
- DPDT Isolated 10 A Contacts
- LED Indicates Relay Status, Faults, & Time Delays
- Universal Line Voltage 200 ... 480 V AC in One Unit
- Compact, Encapsulated Design
- Finger-Safe Terminal Blocks, up to 12 AWG
- ASME A17.1 rule 210.6
- NEMA MG1 14:30, 14:35
- IEEE C62.41-1991 Level B

Approvals: US LISTED

Accessories

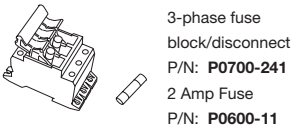

DIN rail adaptor
P/N: **P1023-20**

See accessory pages for specifications.

Description

The HLMU Series is a universal voltage, encapsulated, 3 Phase Voltage Monitor. It continuously measures the voltage of each of the three phases with microcontroller accuracy and compares the value to preset trip points. It separately senses Phase Reversal, Over, Under and Unbalanced voltages including Phase Loss and over or under frequency. Protection is assured during periods of large average voltage fluctuations, or when regenerated voltages are present. The unit trips within 200 ms when phase loss is detected. Adjustable time delays are included to prevent nuisance tripping and short cycling of sensitive equipment. The 10A isolated DPDT output relay contacts trip when a phase voltage exceeds the trip limits for the trip delay. Nominal line voltage, voltage unbalance, and time delays are knob adjustable. The phase loss set point and the acceptable frequency range are fixed. Both Delta and Wye systems can be monitored; no connection to neutral is required.

Operation

Upon application of line voltage, the output is de-energized and the restart delay begins. If all the three phase voltages are within the acceptable range, the output energizes at the end of the restart delay. The microcontroller circuitry automatically senses the voltage range, and selects the correct operating frequency (50 or 60hz). The over and under voltage trip points are set at +/- 10% of the adjusted line voltage. When the measured value of any phase voltage exceeds the acceptable range limits (lower or upper) the trip delay begins. At the end of the trip delay the output relay de-energizes. If the phase voltage returns to an acceptable value before the trip delay expires, the trip delay is reset and the output remains energized. Under, over, and unbalanced voltages plus over or under frequency must be sensed for the complete trip delay before the unit trips. The unit trips in 200 ms when phase loss or reversal are sensed. The unit will not energize if a fault is sensed as the line voltage is applied.

Reset: Reset is automatic upon correction of the voltage or frequency fault or phase sequence.

Connection

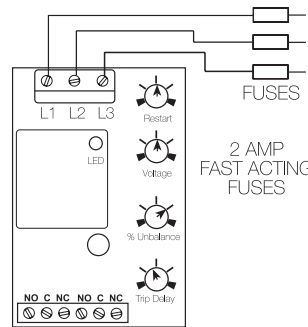

CAUTION: 2 amp max. fast acting fuses are recommended to protect the equipment's wiring. They are not required to protect the HLMU.

L1, L2, L3 = Line Voltage Input
NO = Normally Open Contact NC = Normally Closed Contact
C = Common, Transfer Contact

Note: Relay contacts are isolated, 277 V AC max.

Restart Delay Options:

L= Lockout or minimum OFF time. The restart delay begins when the output trips. The unit cannot be re-energized until the restart delay is complete. This provides a minimum off time or lockout time to allow equipment sensitive to short cycling, time to reset. If the fault is corrected after the restart delay is complete, the output energizes immediately. The restart delay also occurs when line voltage is applied/reapplied.

R= Restart Delay on fault correction. The restart delay begins when line voltage is reapplied or when a voltage fault is corrected. This option is normally selected when staggered restarting of multiple motors on a power system is required.

N= No Restart Delay. 0.6 second initialization delay on application of line voltage applies.

Restart Notes:

All restart options remain reset when the following conditions are detected:

- 1.) Phase Loss (phase unbalance greater than 25%)
- 2.) Average Line Voltage less than 120VAC
- 3.) Phase Reversal

The restart delay begins when the condition is corrected.

LED Operation

The LED flashes green during the restart delay, then glows green when the output energizes. It flashes red during the trip delay then glows red when the output de-energizes. It flashes red/green if phase reversal is sensed. If a fault is sensed during the restart delay, the LED will glow red during that portion or the full restart delay.

LED Flashing Table

Trip Delay	Red	ON/OFF	120 FPM
Restart Delay	Green	ON/OFF	60 FPM
Phase Reversal	Red/Green	Alternate	120 FPM

FPM = Flashes per minute

Ordering Table

HLM Series	X Line Voltage	X Output	X Restart Function	X Voltage Unbalance	X Trip Delay	X Restart Delay
	U - 200 ... 480 V AC	D - DPDT	L - Lockout, Min Off Time R - Staggered Restarting N - No Restart Delay	A - Adjustable 2 ...10% Fixed: Specify Unbalance 2 ...10% in 1% increments, using 2 digits [04]	A - Adjustable 1...30 s Fixed: Specify delay 1 ... 30 s in 1 s increments, using 2 digits, [05]	A - Adjustable 0.6 ...300 s N - No Restart Delay

Example P/N:

HLMUDLAAA = 200 ... 480 V, DPDT, Lockout Restart, Adjustable Unbalance, Trip and Restart Delay

HLMUDNAAN = 200 ... 480 V, DPDT, No Restart Delay, Adjustable Unbalance and Trip Delay

HLMUDRAAA = 200 ... 480 V, DPDT, Staggered Restart, Adjustable Unbalance, Trip and Restart Delay

HLMUDL0405A = 200 ... 480, DPDT, Lockout Restart, Fixed Unbalance 4%, Fixed Trip Delay 5 Seconds, Adjustable Restart

Universal 3 Phase Voltage Monitor HLMU Series (DPDT) Motor Protector

Voltage
Monitors

Technical Data

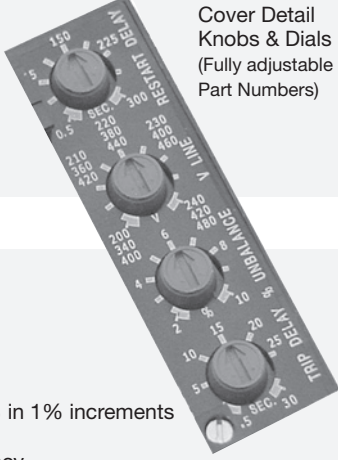
Line Voltage			Cover Detail Knobs & Dials (Fully adjustable Part Numbers)
Type	3 phase Delta or Wye with no connection to neutral		
Operating Voltage	200 ... 480 V AC		
	Range Voltage Adjustment Range Line Frequency 240 200 ... 240 V AC 50 or 60 Hz 380 340 ... 420 V AC 50 Hz 480 400 ... 480 V AC 60 Hz		
Line Voltage Max.	550 V AC		
Line Frequency	50 or 60 Hz Automatically detected		
Phase Loss		≥ 25% Unbalance	
	Response Time	≤ 200ms	
Undervoltage and Voltage Unbalance			
Type		Voltage detection with delayed trip & automatic reset	
Overvoltage:	Trip Voltage	109 to 113% of the adjusted line voltage	
	Reset Voltage	≅ -3% of the trip voltage	
Undervoltage:	Trip Voltage	88 ... 92% of the adjusted line voltage	
	Reset Voltage	≅ +3% of the trip voltage	
Voltage Unbalance:	Trip Set Point	Adjustable 2 ... 10%; or specify fixed unbalance of 2 ... 10% in 1% increments	
	Reset on Balance	≅ -0.7% Unbalance	
Trip Delay	Active On	Over/Undervoltage, Voltage Unbalance, Over/Under Frequency	
	Range	Adjustable from 1 ... 30 s; or specify fixed delay 1 ... 30 s in 1 s increments	
	Tolerance	± 15%	
Restart Delay	Range	Adjustable from 0.6 ... 300 s; if no restart delay is selected a 0.6 s initialization delay applies	
	Tolerance	± 15%	
Over/Under Frequency	Trip / Reset	±4%; Reset ±3%; 50 or 60 Hz	
Phase Sequence		A, B, C, L1, L2, L3	
Response Time-Phase Reversal & Phase Loss		≤ 200 ms	
Reset		Automatic	
Output			
Type		Isolated Electromechanical Relay	
Form		Double pole double throw (DPDT)	
Rating		10 A resistive at 240 V AC; 8 A resistive at 277 V AC; N.O.-1/4 hp at 120 V AC; 1/3 hp at 240 V AC;	
Life		Mechanical -- 1 x 10 ⁶ Electrical -- (at 10 A) -- DPDT = 1 x 30 ³	
Protection			
Surge		IEEE C62.41-1991 Level B	
Isolation Voltage		≥ 2500 V RMS input to output	
Circuitry		Encapsulated	
Mechanical			
Mounting		Surface mount with one #10 (M5 x 0.7) screw	
Package		Note: 0.25 in.(6.35 mm) spacing between units or other devices is required	
Termination		3 x 2 x 1.5 in. (76.7 x 51.3 x 41.7 mm)	
		Screw terminal connection for up to 12 AWG (3.3 mm ²) wire	
Environmental			
Operating Temperature		-40°C ... +60°C	
Storage Temperature		-40°C ... +85°C	
Humidity		95% relative, non-condensing	
Weight		≅ 3.9 oz (111 g)	

7

Mechanical View

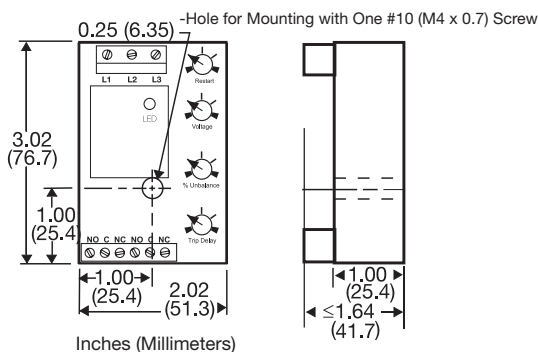

Ambient Temp {Deg. C}

HLMU output rating

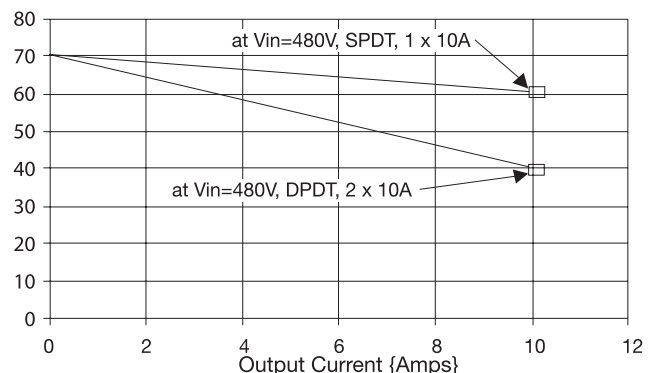

HLM02B01 11.21.06

3 Phase Voltage Monitor

PLMU Series

Universal Plug-in Monitor



ANSI Device #27/47/59



- Protects Against: Phase Loss, Phase Reversal, Overvoltage, Undervoltage, & Unbalanced Voltages
- Octal Plug-in with SPDT Isolated 10 A Contacts
- Operates from 200 ... 480 V AC
- LED Indicator Glows Green when Voltages are Acceptable, Red for Faults
- Simple 3-Wire Connection for Delta or Wye Systems
- ASME A17.1 rule 210.6
- NEMA MG1 14:30, 14:35
- IEEE C62.41-1991 Level B

Approvals:

Accessories

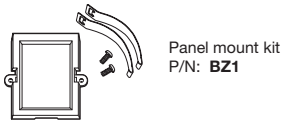

Panel mount kit
P/N: **BZ1**

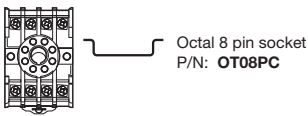

Octal 8 pin socket
P/N: **OT08PC**

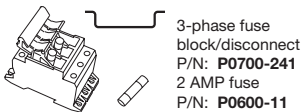

3-phase fuse block/disconnect
P/N: **P0700-241**
2 AMP fuse
P/N: **P0600-11**

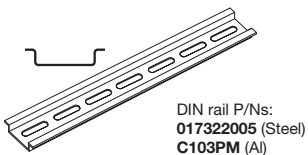

DIN rail P/Ns:
017322005 (Steel)
C103PM (Al)

See accessory pages for specifications.

Description

The PLMU Series continuously measures the voltage of each of the three phases to provide protection for three phase motors and sensitive loads. Its microcontroller senses under and over voltage, voltage unbalance, phase loss, and phase reversal. Protection is provided even when regenerated voltages are present. Universal voltage operation and standard base connection allows the PLMU to replace hundreds of competitive part numbers.

Operation

Upon application of power, a 0.6 s random start delay begins and the PLMU measures the voltage levels and line frequency and selects the voltage range. The output relay is energized and the LED glows green when all voltages are acceptable and the phase sequence is correct. LED flashes green during trip delay, glows red when output de-energizes. Undervoltage, overvoltage, and voltage unbalance must be sensed for continuous trip delay before the relay de-energizes. Re-energization is automatic upon fault correction. The output relay will not energize if a fault condition is sensed as three phase input voltage is applied. Line voltage is selected with the knob, setting the over and under voltage trip points. Voltage range is automatically selected by the microcontroller.

Connection

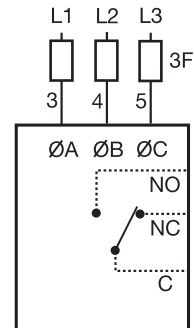

2 Amp Fast Acting Fuses Recommended For Safety (Not Required)

F = Fuses
 \emptyset A = Phase A = L1
 \emptyset B = Phase B = L2
 \emptyset C = Phase C = L3
 NO = Normally Open
 NC = Normally Closed

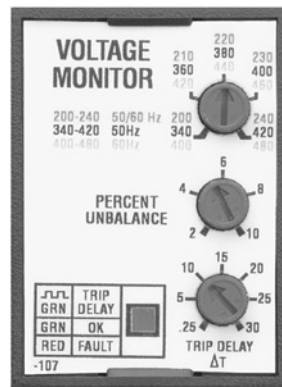

Faceplate View

Relay contacts are isolated. Dashed lines are internal connections.

Ordering Table

<u>Voltage Unbalance</u>	<u>Trip Delay</u>	<u>Part Number</u>
Adjustable 2 ... 10%	Adjustable 0.25 ... 30 s	PLMU11

Available with Fixed Unbalance and Trip Delay

3 Phase Voltage Monitor

PLMU Series

Universal Plug-in Monitor

Voltage
Monitors

Technical Data

Line Voltage Type Line Voltage Adjustable Voltage Ranges (Automatic Range Selection) Maximum Voltage Phase Sequence	Three phase Delta or Wye with no connection to neutral 200 ... 480 V AC +/-15%; 50 ... 60 Hz +/-2 Hz 200 ... 240 V AC, 50 ... 60 Hz 340 ... 420 V AC, 50 Hz 400 ... 480 V AC, 60 Hz 552 V AC ABC																		
Overvoltage, Undervoltage, & Voltage Unbalance Type Overvoltage & Undervoltage Undervoltage Trip Point Reset Voltage Overvoltage Trip Point Reset Voltage Voltage Unbalance Trip Point Reset on Balance (%): Selected Unbalance Reset	Voltage detection with delayed trip & automatic reset 88 ... 92% of adjusted line voltage +2% of trip voltage 109 ... 113% of adjusted line voltage -2% of trip voltage Adjustable from 2 ... 10% or fixed 4 ... 10% <table border="1"> <tr> <td>2</td><td>3</td><td>4</td><td>5</td><td>6</td><td>7</td><td>8</td><td>9</td><td>10</td> </tr> <tr> <td>1.5</td><td>2.5</td><td>3.5</td><td>4.5</td><td>5.4</td><td>6.3</td><td>7.2</td><td>8.1</td><td>9</td> </tr> </table>	2	3	4	5	6	7	8	9	10	1.5	2.5	3.5	4.5	5.4	6.3	7.2	8.1	9
2	3	4	5	6	7	8	9	10											
1.5	2.5	3.5	4.5	5.4	6.3	7.2	8.1	9											
Trip Delay Range Severe Unbalance - 2X Selected Unbalance Random Start Delay	Adj. from 0.25 ... 30 s or fixed 2 ... 30 s +/-15% 0.25 ... 2 s; disabled when the trip delay is less than 2 s ≅ 0.6 s																		
Phase Reversal & Phase Loss Trip Time Phase Loss Set Point Reset Type	≤ 150 ms ≥ 15% unbalance Automatic																		
Output Type Rating Life	Energized when voltages are acceptable 10 A resistive @ 240 V AC; 1/4 hp @ 125 V AC; 1/3 hp @ 250 V AC; max. voltage 277 V AC Mechanical -- 1 x 10 ⁶ ; Electrical -- 1 x 10 ⁵																		
Protection Surge Isolation Voltage	IEEE C62.41-1991 Level B ≥ 2500 V RMS input to output																		
Mechanical Mounting* Termination Package	Plug-in socket rated 600 V AC 8 Pin octal plug 3.03 x 2.39 x 1.78 in. (77.0 x 60.7 x 45.2 mm) *CAUTION: Select an octal socket rated for 600 V AC operation.																		
Environmental Operating Temperature Storage Temperature Weight	-40°C ... +60°C -40°C ... +85°C ≅ 8.6 oz (244 g)																		

7

Mechanical View

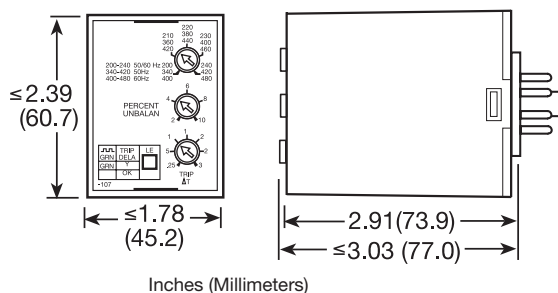

3 Phase Voltage Monitor PLM Series Motor Protector



US Pat #6541954
ANSI Device # 47/27



- Protects Against: Phase Loss, Phase Reversal, Undervoltage, & Unbalanced Voltages
- 8 Pin Plug-in Base
- Adjustable Low Voltage Trip Point
- Factory Fixed Unbalance and Trip Delay
- Line Voltages 200...480 V AC, in 3 Ranges
- SPDT Isolated 10 A Relay Contacts
- ASME A17.1 rule 210.6
- NEMA MG1 14:30, 14:35
- IEEE C62.41-1991 Level B

Approvals:

Accessories

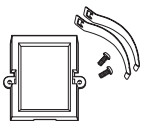

Panel mount kit
P/N: **BZ1**

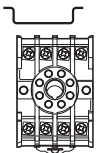

Octal
8 pin socket
P/N: **OT08PC**

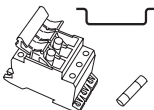

3-phase fuse
block/disconnect
P/N: **P0700-241**
2 AMP fuse
P/N: **P0600-11**

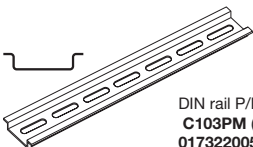

DIN rail P/Ns:
C103PM (Al)
017322005 (Steel)

See accessory pages for specifications.

Description

The PLM Series continuously measures the voltage of each of the three phases. The PLM Series uses a new microcontroller circuit design that senses Undervoltage, Voltage Unbalance, Phase Loss, and Phase Reversal. Protection is assured when regenerated voltages are present. Both Delta and Wye systems can be monitored; no connection to neutral is required.

Operation

The output relay is energized and the LED glows green when all voltages are acceptable and the phase sequence is correct. Under and unbalanced voltages must be sensed for a continuous trip delay period before the relay de-energizes. Reset is automatic upon correction of the fault condition. The output relay will not energize if a fault condition is sensed as power is applied. The LED flashes red during the trip delay, then glows red when the output de-energizes. The LED flashes green/red if phase reversal is sensed.

Field Adjustment:

Set voltage adjustment knob at the desired operating line voltage for the equipment. This adjustment automatically sets the undervoltage trip point. Apply power. If the PLM fails to energize, (LED glows red) check wiring of all 3 phases, voltage, and phase sequence. If phase sequence is incorrect, the LED flashes green/red. To correct this, swap any two line voltage connections at the mounting socket. No further adjustment should be required.

Connection

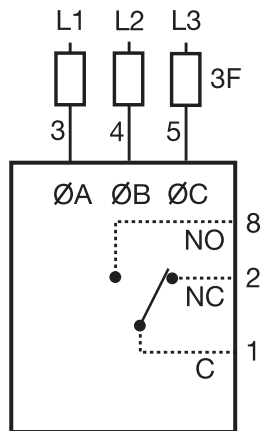

2 Amp
Fast Acting
Fuses
are
Recommended
For Safety
(Not Required)

Relay contacts are isolated.
Dashed lines are internal connections.

F = Fuses NO = Normally Open
NC = Normally Closed

Ordering Table

PLM Series	X Line Voltage	X Voltage Unbalance (Fixed)	X Trip Delay (Fixed)
	6 - 240 V AC	Specify: 4, 5, 6, 7, or 8%	Specify from 2 ... 20 s in 1 s increments (Insert 0 before 1 ... 9)
	8 - 380 V AC		
	9 - 480 V AC		

Example P/N: **PLM6405, PLM9410**

3 Phase Voltage Monitor

PLM Series

Motor Protector

Technical Data

Line Voltage		
Type	3 phase Delta or Wye with no connection to neutral	
Operating Voltage:	Model	Adj. Line Voltage Range Line Voltage Max.
	240	200 ... 240 V AC 270 V AC
	380	360 ... 430 V AC 480 V AC
	480	400 ... 480 V AC 530 V AC
Line Frequency	50 ... 100 Hz	
Phase Sequence	ABC	
Power Consumption	≅ 2W for 240 V units ≅ 3W for 380 ... 480 V units	
Low Voltage and Voltage Unbalance		
Type	Voltage detection with delayed trip & automatic reset	
Low Voltage:	Trip Voltage	88 ... 92% of adjusted line voltage
	Reset Voltage	Plus 3% of trip voltage
Voltage Unbalance:	Trip Unbalance	Factory fixed from 4 ... 8%
	Reset on Balance	-0.7% unbalance typical
Trip Delay:	Range	Factory fixed from 2 ... 20 s
	Tolerance	+/-15%
Phase Reversal and Phase Loss		
Response Time --	Phase Reversal	≤ 200 ms
	Phase Loss	≤ 200 ms
Phase Loss		≥ 35% unbalance
Reset		Automatic
Output		
Type	Electromechanical relay	
Form	Isolated single pole double throw (SPDT)	
Rating	10 A resistive at 240 V AC, 277 V AC Max. 1/2 Hp at 240 V AC; 1/4 Hp at 120 V AC	
Life	Mechanical -- 1 x 10 ⁷ ; Electrical --1 x 10 ⁵	
Protection		
Surge	IEEE C62.41-1991 Level B	
Isolation Voltage	≥ 2500 V RMS input to output	
Mechanical		
Mounting*	8 pin plug-in socket rated 600 V AC	
Package	3.2 x 2.39 x 1.78 in. (81.3 x 60.7 x 45.2 mm) *CAUTION: Select an octal socket rated for 600 V AC operation.	
Environmental		
Operating Temperature	-40°C ... +60°C	
Storage Temperature	-40°C ... +85°C	
Weight	≅ 4.4 oz (125 g)	

7

Mechanical View

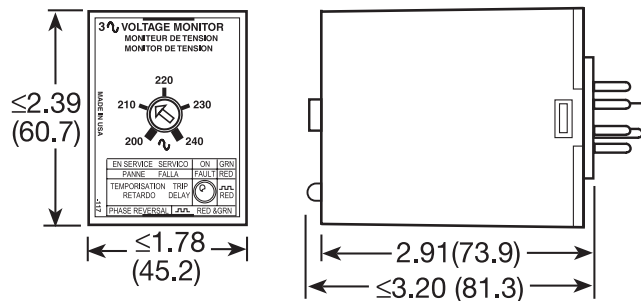

Inches (Millimeters)

Compact 3 Phase Voltage Monitor TVW Series The Net™ Motor Protector



US Patent 6541954
ANSI Device # 27/47/59



- Protects Against: Phase Loss, Phase Reversal, Under, Over, and Unbalanced Voltages, Short Cycling
- Fixed Trip Points and Delays
- Adjustable Voltages from 208 ... 480 V A C in 4 Ranges
- Monitor 600 V AC Lines by Connecting VRM Accessory
- Isolated 10 A, SPDT Relay Contacts
- Bi-color LED Indicator Shows: Output Status, Faults, Time Delays, Phase Reversal and Set Point
- ASME A17.1 rule 210.6
- NEMA MG1 14:30, 14:35
- IEEE C62.41-1991 Level B

Approvals:



Accessories



Female quick connect P/Ns:
P1015-13 (AWG 10/12)
P1015-64 (AWG 14/16)
P1015-14 (AWG 18/22)

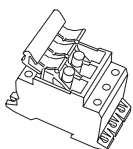

3-phase fuse block/disconnect P/N: P0700-241
2 Amp Fuse P/N: P0600-11



See accessory pages for specifications.

Description

Provides protection for motors and other sensitive loads. Continuously measures the voltage of each of the three phases using a new microcontroller circuit design that senses under and overvoltage, voltage unbalance, phase loss, and phase reversal. Protection is provided even when regenerated voltages are present. Includes a trip delay to prevent nuisance tripping and a restart delay to prevent short cycling after a momentary power outage.

Operation

Upon application of line voltage, the restart delay begins. The output is de-energized during restart delay. Under normal conditions, the output energizes after the restart delay. Undervoltage, overvoltage, and voltage unbalance must be sensed for the complete trip delay period before the output de-energizes. The restart delay begins as soon as the output de-energizes. If the restart delay is completed when a fault is corrected, the output energizes immediately. The output will not energize if a fault is sensed as the input voltage is applied. If the voltage selector is set between two voltage marks (e.g. between 220 and 230 V), the LED will flash red rapidly. The TVW provides fault protection at the lower of the two line voltages (e.g. 220 V).
Reset: Reset is automatic upon correction of a fault.

LED Operation

The LED flashes green during the restart delay, then glows green when the output energizes. It flashes red during the trip delay then glows red when the output de-energizes. It flashes red/green if phase reversal is sensed. If the voltage selector knob is between settings, it rapidly flashes red.

LED Flashing Table

Trip Delay	Red	ON/OFF	115 FPM
Restart Delay	Green	ON/OFF	57 FPM
Phase Reversal	Red/Green	Alternate	115 FPM
Voltage Selector Between Marks	Red	ON/OFF	460 FPM (7.5 FPS)

FPM = Flashes per minute
FPS = Flashes per second

Connection

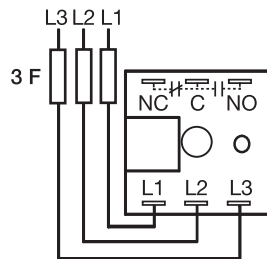

Relay contacts are isolated. Dashed lines are internal connections.

F = 2 A Fast Acting Fuses are recommended, but not required.

L1 = Phase A L2 = Phase B L3 = Phase C
NO = Normally Open NC = Normally Closed
C = Common, Transfer Contact

Mechanical View

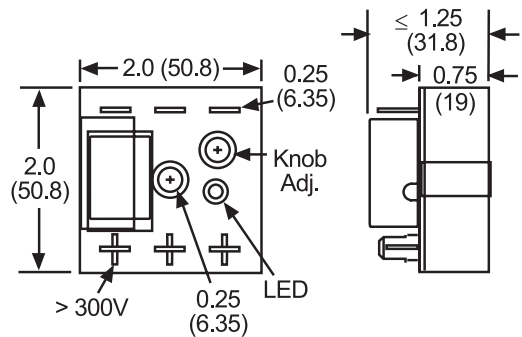

Inches (Millimeters)

Ordering Table

TVW Series	X Line Voltage Wide Range	X Voltage Unbalance Specify Fixed Percentage	X Trip Delay Specify Fixed Delay In Seconds (S)	X Restart Delay Specify Fixed Delay In Seconds (S)
	5 - 208 ... 240 V AC	4, 5, 6, 7, 8, 9, or 10	[0.2 ... 1] In 0.1 s Increments [1 ... 100] In 1 s Increments	[0.4 ... 1] In 0.1 s Increments [1 ... 100] In 1 s Increments In Minutes (M) [1 ... 999] In 1 M Increments
	6 - 208, 220, 230 & 240 V AC			
	8 - 380, 400 & 415 V AC			
	9 - 430, 440, 460 & 480 V AC			

Example P/N: TVW645S10S = 208, 220, 230 & 240 V AC, 4% Voltage Unbalance, 5 Second Trip Delay, 10 Second Restart Delay
TVW960.2S1M = 430, 440, 460 & 480 V AC, 6% Voltage Unbalance, 0.2 Second Trip Delay, 1 Minute Restart Delay

Compact 3 Phase Voltage Monitor TVW Series The Net™ Motor Protector

Voltage
Monitors

Technical Data

Line Voltage Type Input Voltage/Tolerance Line Frequency Phase Sequence Power Consumption	Three phase Delta or Wye with no connection to neutral 208 ... 480 V AC in 4 ranges/-30% ... +20% 50 ... 100 Hz ABC Approx. 2 W for 240 V units Approx. 3 W for 480 V units
Overvoltage, Undervoltage, & Voltage Unbalance Overvoltage & Undervoltage Undervoltage Trip Point Reset Voltage Overvoltage Trip Point Reset Voltage Trip Variation vs Temperature Voltage Unbalance Reset On Balance Trip Delay Range Restart Delay Range	Voltage detection with delay trip & automatic reset 88 ... 92% of the selected line voltage $\pm 3\%$ of trip voltage 109 ... 113% of the selected line voltage $\pm 3\%$ of trip voltage $\leq \pm 2\%$ Factory fixed, from 4 ... 10% $\pm 0.7\%$ unbalance Fixed, from 0.2 ... 100 s, $\pm 15\%$ or ± 0.1 s, whichever is greater Fixed, from 0.4 s ... 999 m, $\pm 15\%$ or ± 0.1 s, whichever is greater
Phase Reversal & Phase Loss Response Phase Loss	≤ 200 ms; automatic reset $\geq 25\%$ unbalance
Output Type Rating	Isolated SPDT relay contacts 10 A resistive @ 125 V AC, 5 A @ 250 V AC, 1/4 hp @ 125 V AC 10 A resistive @ 240 V AC, 1/4 hp @ 125 V AC, 1/3 hp @ 250 V AC; max. voltage 277 V AC Mechanical-- 1×10^6 ; Electrical -- 1×10^5
Life	
Protection Surge Dielectric Breakdown	IEEE C62.41-1991 Level B ≥ 1500 V RMS input to output terminals ≥ 2500 V RMS input to output terminals
Mechanical Mounting Termination	Surface mount with one #8 (M5 x 0.8) screw 0.25 in. (6.35 mm) male quick connect terminals
Environmental Storage Temperature Humidity Weight	$-40^\circ\text{C} \dots +85^\circ\text{C}$ 95% relative, non-condensing ≈ 2.8 oz (79 g)

Operating Temperature

Line VAC	Output A/Line V	Unmounted	On Metal Surface
208/240V	@1A, Nom.V	$-40^\circ\text{C} \dots +70^\circ\text{C}$	$+75^\circ\text{C}$
208/240V	@1A, +110%V	$-40^\circ\text{C} \dots +65^\circ\text{C}$	$+70^\circ\text{C}$
380/480V	@1A, Nom.V	$-40^\circ\text{C} \dots +65^\circ\text{C}$	$+70^\circ\text{C}$
380/480V	@1A, +110%V	$-40^\circ\text{C} \dots +60^\circ\text{C}$	$+65^\circ\text{C}$

7

Accessory

VRM Voltage Reduction Module

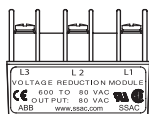

P/N: **VRM6048**

The VRM6048 Accessory Module allows the TVW9XXX to monitor a 3-Phase 550 ... 600 V AC Line.

Voltage:	INPUT	*OUTPUT
	600 V AC	480 V AC
	575 V AC	460 V AC
	550 V AC	440 V AC

Package: Molded Housing with Encapsulated Circuitry
 Mounting: Surface Mount with One #10 (M5 x 0.8) Plastic Screw. May be DIN Rail Mounted Using P1023-20 Adaptor
 Termination: Screw Terminals with Captive Wire Clamps for up to No.12 AWG Wire.

Connection

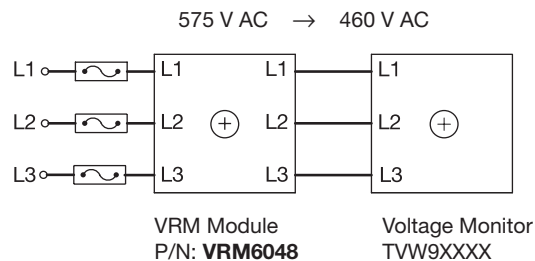

* The VRM6048 must be connected as shown. If the TVW9XXX is disconnected, the VRM output voltage equals the input voltage.

Adjustment: If the measured line voltage is 575 V AC, connect as shown and adjust the TVW9XXX for 460 V AC operation.

Operating: -40°C to $+70^\circ\text{C}$
 Storage: -40°C to $+85^\circ\text{C}$
 Humidity: 95% Relative, Non-Condensing

Mechanical View

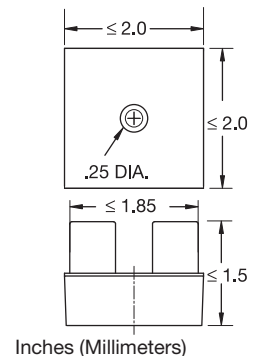

TVW02B01 08.26.04

Compact 3 Phase Voltage Monitor TVM Series The Net™ Motor Protector



US Patent 6541954
ANSI Device #27/47/59



- Protects Against: Phase Loss, Phase Reversal, Under, Over, and Unbalanced Voltages, Short Cycling
- Fixed Trip Points and Delays
- Fixed Voltages from 208 .. 480 V AC
- Isolated 10 A, SPDT Relay Contacts
- Bi-color LED Indicator Shows: Output Status, Faults, Time Delays and Phase Reversal
- ASME A17.1 rule 210.6
- NEMA MG1 14:30, 14:35
- IEEE C62.41-1991 Level B

Approvals:

Description

Provides protection for motors and other sensitive loads. Continuously measures the voltage of each of the three phases using a new microcomputer circuit design that senses under and over voltage, voltage unbalance, phase loss, and phase reversal. Protection is provided even when regenerated voltages are present. Includes a trip delay to prevent nuisance tripping and a restart delay to prevent short cycling after a momentary power outage.

Operation

Upon application of line voltage, the restart delay begins. The output relay is de-energized during restart delay. Under normal conditions, the output energizes after restart delay. Undervoltage, overvoltage, and voltage unbalance must be sensed for continuous trip delay period before the output is de-energized. The output will not de-energize if a fault is corrected during the trip delay. The restart delay begins as soon as the output relay de-energizes. If the restart delay is completed when the fault is corrected, the output relay will energize immediately. The output relay will not energize if a fault or phase reversal is sensed as three phase input voltage is applied.

Reset: Reset is automatic upon correction of a fault.

LED Operation

The LED flashes green during the restart delay, then glows green when the output energizes. It flashes red during the trip delay then glows red when the output de-energizes. It flashes red/green if phase reversal is sensed.

LED Flashing Table

Trip Delay	Red	ON/OFF	115 FPM
Restart Delay	Green	ON/OFF	57 FPM
Phase Reversal	Red/Green	Alternate	115 FPM

FPM = Flashes per minute

Connection

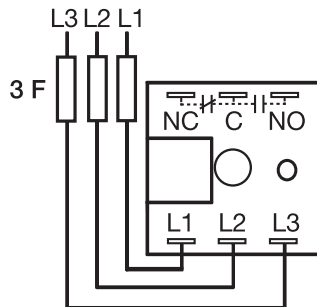

Relay contacts are isolated. Dashed lines are internal connections.

F = 2A Fast Acting Fuses are recommended, but not required.

L1 = Phase A L2 = Phase B L3 = Phase C
NO = Normally Open NC = Normally Closed
C = Common, Transfer Contact

Mechanical View

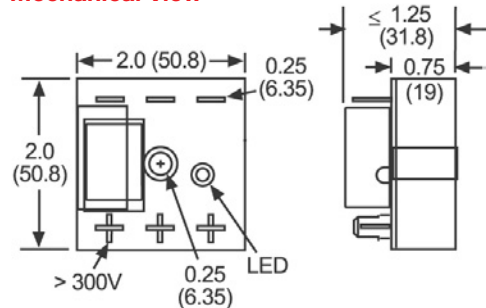

Inches (Millimeters)

Accessories



Female quick connect P/Ns:
P1015-13 (AWG 10/12)
P1015-64 (AWG 14/16)
P1015-14 (AWG 18/22)

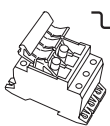

3-phase fuse block/disconnect
P/N: P0700-241
2 Amp Fuse
P/N: P0600-11

See accessory pages for specifications.

Ordering Table

TVM Series	X Line Voltage	X Voltage Unbalance	X Trip Delay	X Restart Delay
	208 A - 208 V AC	Specify Fixed Percentage 4, 5, 6, 7, 8, 9, or 10	Specify Fixed Delay In Seconds (S) [0.2 ... 1] In 0.1 s Increments [1 ... 100] In 1 s Increments	Specify Fixed Delay In Seconds (S) [0.4 ... 1] In 0.1 s Increments [1 ... 100] In 1 s Increments In Minutes (M) [1 ... 999] In 1 M Increments
	220 A - 220 V AC			
	230 A - 230 V AC			
	240 A - 240 V AC			
	380 A - 380 V AC			
	400 A - 400 V AC			
	415 A - 415 V AC			
	440 A - 440 V AC			
	460 A - 460 V AC			
	480 A - 480 V AC			

Example P/N: TVM240A45S10S

Compact 3 Phase Voltage Monitor TVM Series The Net™ Motor Protector

Voltage
Monitors

Technical Data

Line Voltage Type Input Voltage Line Frequency Phase Sequence Power Consumption	Three phase Delta or Wye with no connection to neutral 208 ... 480 V AC (See Ordering Table) 50 ... 100 Hz ABC Approx. 2 W for 240 V units Approx. 3 W for 480 V units
Overvoltage, Undervoltage, & Voltage Unbalance Overvoltage & Undervoltage Undervoltage Trip Point Reset Voltage Overvoltage Trip Point Reset Voltage Trip Variation vs Temperature Voltage Unbalance Reset On Balance Trip Delay Range Restart Delay Range	Voltage detection with delay trip & automatic reset 88 ... 92% of the selected line voltage $\pm 3\%$ of trip voltage 109 ... 113% of the selected line voltage $\pm 3\%$ of trip voltage $\leq \pm 2\%$ Factory fixed, from 4 ... 10% $\pm 0.7\%$ unbalance Fixed, from 0.2 ... 100 s, $\pm 15\%$ or ± 0.1 s, whichever is greater Fixed, from 0.4 s ... 999 m, $\pm 15\%$ or ± 0.1 s, whichever is greater
Phase Reversal & Phase Loss Response Phase Loss	≤ 200 ms; automatic reset $\geq 25\%$ unbalance
Output Type Rating	Isolated SPDT relay contacts 10 A resistive @ 125 V AC, 5 A @ 250 V AC, 1/4 hp @ 125 V AC 10 A resistive @ 240 V AC, 1/4 hp @ 125 V AC, 1/3 hp @ 250 V AC; max. voltage 277 V AC Mechanical -1×10^6 ; Electrical -1×10^5
Life	
Protection Surge Dielectric Breakdown	IEEE C62.41-1991 Level B ≥ 1500 V RMS input to output terminals ≥ 2500 V RMS input to output terminals
Mechanical Mounting Termination	Surface mount with one #8 (M5 x 0.8) screw 0.25 in. (6.35 mm) male quick connect terminals
Environmental Storage Temperature Humidity Weight	$-40^\circ\text{C} \dots +85^\circ\text{C}$ 95% relative, non-condensing ≈ 2.8 oz (79 g)

Operating Temperature

Line VAC	Output A/ Line V	Unmounted	On Metal Surface
208/240V	@1A, Nom.V	$-40^\circ\text{C} \dots +70^\circ\text{C}$	$+75^\circ\text{C}$
208/240V	@1A, $+110\%$ V	$-40^\circ\text{C} \dots +65^\circ\text{C}$	$+70^\circ\text{C}$
380/480V	@1A, Nom.V	$-40^\circ\text{C} \dots +65^\circ\text{C}$	$+70^\circ\text{C}$
380/480V	@1A, $+110\%$ V	$-40^\circ\text{C} \dots +60^\circ\text{C}$	$+65^\circ\text{C}$

7

Accessory

VRM Voltage Reduction Module

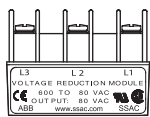

P/N: **VRM6048**

The VRM6048 Accessory Module allows the TVM9XXX to monitor a 3-Phase 550 ... 600 V AC Line.

Voltage:	INPUT	*OUTPUT
	600 V AC	480 V AC
	575 V AC	460 V AC
	550 V AC	440 V AC

Package: Molded Housing with Encapsulated Circuitry
 Mounting: Surface Mount with One #10 (M5 x 0.8) Plastic Screw. May be DIN Rail Mounted Using P1023-20 Adaptor
 Termination: Screw Terminals with Captive Wire Clamps for up to No.12 AWG Wire.

Connection

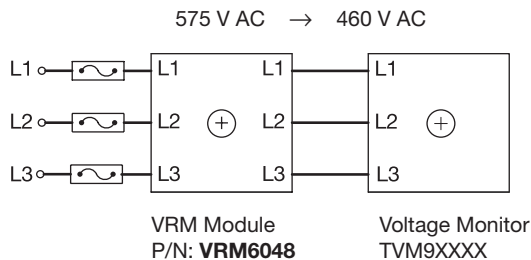

* The VRM6048 must be connected as shown. If the TVM9XXX is disconnected, the VRM output voltage equals the input voltage.

Adjustment: If the measured line voltage is 575 V AC, connect as shown and adjust the TVM9XXX for 460 V AC operation.

Operating: -40°C to $+70^\circ\text{C}$
 Storage: -40°C to $+85^\circ\text{C}$
 Humidity: 95% Relative, Non-Condensing

Mechanical View

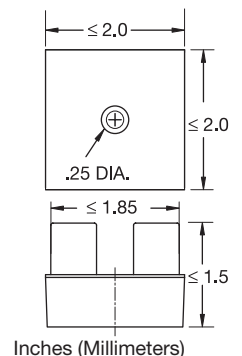

TVM02E01 01.20.05

3 Phase Voltage Monitor PLR Series Motor Protector



US Patent No. 6541954
ANSI Device # 27/32



- Protects Against: Phase Loss (On Startup), Phase Reversal, Undervoltage
- Used Where Moderate Voltage Unbalance Protection is Not Required
- Direct Replacement for Most Popular 3 Phase Monitors
- 8 Pin Octal Base Connection
- SPDT Isolated 5 A Relay Contacts
- AMSE A17.1 rule 210.6
- NEMA MG1 14:30, 14:35
- IEEE C62.41-1991 Level B

Approvals:

Accessories

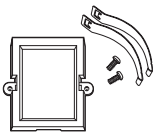

Panel mount kit
P/N: **BZ1**

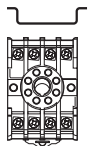

Octal
8-pin socket
P/N: **OT08PC**

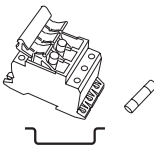

3-phase fuse
block/disconnect
P/N: **P0700-241**
2 AMP fuse
P/N: **P0600-11**

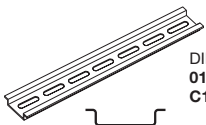

DIN rail P/Ns:
017322005 (Steel)
C103PM (Al)

See accessory pages for specifications.

Description

The PLR Series provides a cost effective means of preventing 3 phase motor startup during adverse voltage conditions. Proper A-B-C sequence must occur in order for the PLR's output contacts to energize. In addition, the relay will not energize when an undervoltage or phase loss condition is present. The PLR protects a motor against undervoltage operation. The adjustment knob sets the undervoltage trip point.

Operation

The output relay is energized and the LED glows when all voltages are acceptable and the phase sequence is correct. Undervoltage must be sensed for a continuous dropout delay period before the relay de-energizes. Reset is automatic upon correction of the fault condition. The output relay will not energize if a fault condition is sensed as power is applied.

Field Adjustment:

Turn the adjustment knob fully counterclockwise and apply three-phase power. The LED should be ON. Increase adjustment until the LED goes OFF. Decrease adjustment until LED glows again. If nuisance tripping occurs, decrease the adjustment slightly.

NOTE: When properly adjusted and operating in an average system, a voltage unbalance of 10% or more is required for phase loss detection. When a phase is lost while the motor is running, a voltage will be induced into the open phase nearly equal in magnitude to the normal phase-to-phase voltage. This condition is known as regeneration. When regenerated voltages are present, the voltage unbalance during single phasing may not exceed 10% for some motors. The PLR Series may not provide protection under this condition. For systems that require superior phase loss protection, select the PLMU Series.

Connection

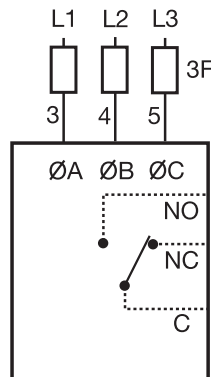

2 Amp
Fast Acting
Fuses
Recommended
For Safety
(Not Required)

F = Fuses
ØA = Phase A = L1
ØB = Phase B = L2
ØC = Phase C = L3
NO = Normally Open
NC = Normally Closed

Relay contacts are isolated. Dashed lines are internal connections.

Ordering Table

Voltage	Part Number
95 ... 140 V AC	PLR120A
190 ... 270 V AC	PLR240A
340 ... 450 V AC	PLR380A
380 ... 500 V AC	PLR480A

3 Phase Voltage Monitor

PLR Series

Motor Protector

Voltage
Monitors

Technical Data

Line Voltage		3 phase Delta or Wye with no connection to neutral		
Type		Nominal Voltage	Undervoltage Dropout Adjustment Range	Line Voltage Max.
		120 V AC	85 ... 130 V AC	143 V AC
		240 V AC	170 ... 240 V AC	270 V AC
		380 V AC	310 ... 410 V AC	480 V AC
		480 V AC	350 ... 480 V AC	530 V AC
Frequency		50 ... 60 Hz		
Phase Sequence		ABC		
Response Times				
Pull-in		≤ 400 ms		
Drop-out		≤ 100 ms		
Hysteresis	Pull-in/Drop-out	≅ 2%		
Output				
Type		Electromechanical relay, energized when all voltages are acceptable		
Form		Single pole double throw (SPDT)		
Rating		5 A resistive at 240 V AC: 1/4 Hp at 120 V AC		
Maximum Voltage		250 V AC		
Protection				
Surge		IEEE C62.41-1991 Level B		
Isolation Voltage	120 & 240 V AC 380 & 480 V AC	≥ 1500 V RMS input to output ≥ 2500 V RMS input to output		
Mechanical				
Mounting		Plug-in socket		
Termination		8 pin, octal plug		
Environmental				
Operating Temperature		0°C ... +55°C		
Storage Temperature		-40°C ... +85°C		
Weight		≅ 6 oz (170 g)		

7

Mechanical View

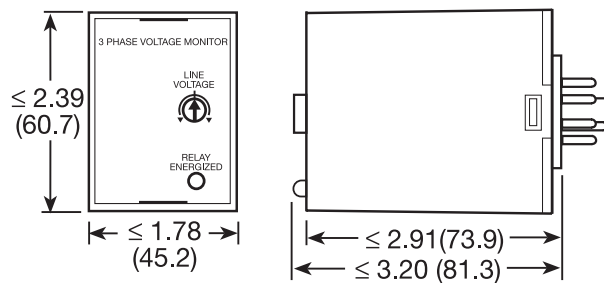

Inches (Millimeters)

Reverse Phase Relay

PLS Series

Motor Protector



- Protects Against Phase Reversal
- Low Cost Protection, One Unit for All Sized Motors
- 3 Wire Connection for Delta or Wye Systems
- Octal Base Connection-- Industry Standard Wiring
- SPDT Isolated Relay Contacts
- Factory Calibrated--No Adjustments Required

Approvals:

Accessories

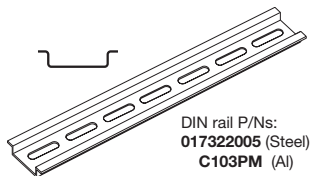
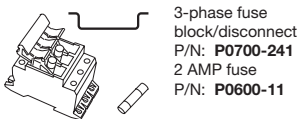
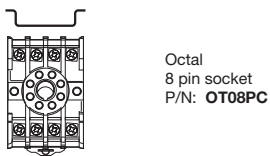
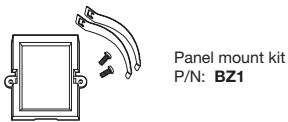

See accessory pages for specifications.

Description

The PLS Series is a low cost phase sensitive control that provides an isolated contact closure when the proper A-B-C phase sequence is applied. Protects sensitive 3 phase equipment and equipment operators from reverse rotation. Designed to be compatible with motor overloads or other 3 phase equipment protection devices. Protection for equipment control centers where frequent reconnection or electrical code makes reverse rotation protection essential. Examples include, mobile refrigerated containers, construction equipment, hoists, pumps, conveyors, elevators and escalators.

Operation

The internal relay and LED are energized when the phase sequence is correct. The output relay will not energize if the phases are reversed. Reset is automatic upon correction of the fault.

Connection

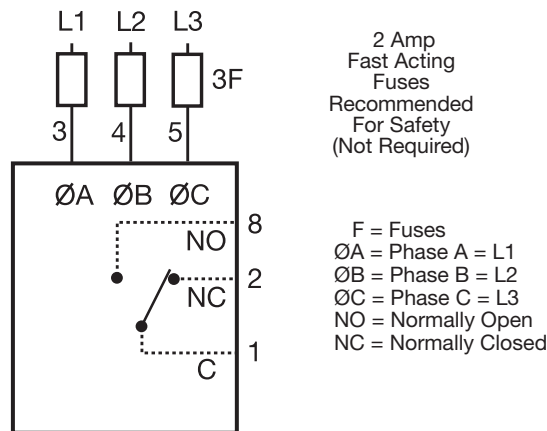

Relay contacts are isolated. Dashed lines are internal connections.

Ordering Table

Voltage	Part Number
120 V AC	PLS120A
208/240 V AC	PLS240A
380/415 V AC	PLS380A
440/480 V AC	PLS480A

Reverse Phase Relay

PLS Series

Motor Protector

Voltage
Monitors

Technical Data

Line Voltage		3-phase Delta or Wye with no connection to neutral		
Type		Nominal Voltage	Minimum Voltage	Maximum Voltage
		120 V AC	95 V AC	135 V AC
		208/240 V AC	175 V AC	255 V AC
		380/415 V AC	310 V AC	430 V AC
		440/480 V AC	380 V AC	500 V AC
Frequency		50 ... 60 Hz		
Phase Sequence		ABC		
Response Times				
Pull-in		≤ 300 ms		
Drop-out		≤ 50 ms		
Output		Electromechanical relay, energized when the phase sequence is correct		
Type		Isolated SPDT		
Form		10 A resistive at 240 V AC		
Rating	120 & 240 V AC	8 A resistive at 240 V AC		
	380 & 480 V AC	250 V AC		
Maximum Voltage				
Protection				
Isolation Voltage	120 & 240 V AC	≥ 1500 V RMS input to output		
	380 & 480 V AC	≥ 2500 V RMS input to output		
Mechanical		Plug-in socket		
Mounting		8 pin, octal plug		
Termination				
Environmental				
Operating Temperature		-40°C ... +55°C		
Storage Temperature		-40°C ... +85°C		
Weight		≅ 6 oz (170 g)		

7

Mechanical View

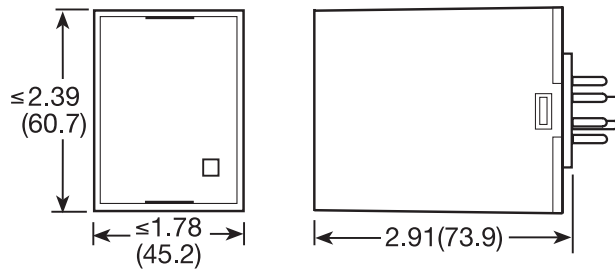

Inches (Millimeters)

Single Phase Undervoltage Monitor

HLV Series

30 A SPDT Relay Output



US Patent 6708135

- Protects against undervoltage in Single Phase Systems
- 30 A SPDT N.O. Output Contacts
- 100 ... 240 VAC Input Voltage
- 70 ... 220 VAC Adjustable Undervoltage Trip Point in 2 Ranges
- Restart Delays from 3 ... 300 s
- Trip Delay 1 ... 20 s Fixed
- Isolated or Non Isolated Relay Contacts

Approvals:

Description

The HLV Series is a single phase undervoltage monitor designed to protect sensitive equipment from brownout or undervoltage conditions. Time delays are included to prevent nuisance tripping and short cycling. The 30 A, 1 hp rated SPDT relay contacts allow direct control of motors, solenoids and valves. The output relay can be ordered with isolated SPDT contact to allow monitoring of one voltage and switching a separate voltage. Two undervoltage trip point ranges allow monitoring of 110 to 120 VAC or 208 to 240 VAC systems.

Connection

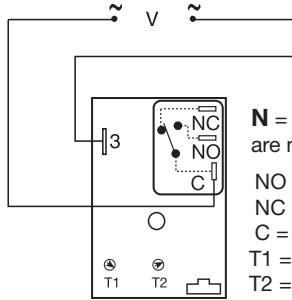

N = Relay contacts are non-isolated.

NO = Normally Open
NC = Normally Closed
C = Common

T1 = Undervoltage Trip Point
T2 = Restart Delay

Dashed lines are internal connections.

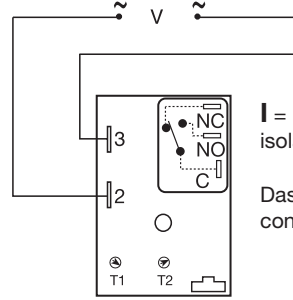

I = Relay contacts are isolated.

Dashed lines are internal connections.

Function

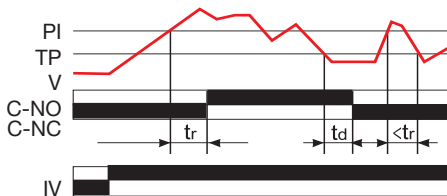

tr = Restart Delay
td = Trip Delay
PI = Pull-in 105% or trip point
TP = Trip Point
V = Monitored Voltage
IV = Input voltage
C-NO = Normally Open Contacts
C-NC = Normally Closed Contacts

Operation

Upon application of input voltage the output relay remains de-energized. When the input voltage value is above the pull-in voltage, the restart delay begins. At the end of the restart delay, the output relay energizes. When the input voltage falls below the trip point, the trip delay begins. If the input voltage remains below the pull-in voltage for the entire trip delay the relay de-energizes. If the input voltage returns to a value above the pull-in voltage, during the trip delay, the trip delay is reset and the relay remains energized. If the input voltage falls below the trip point voltage during the restart delay, the delay is reset and the relay remains de-energized. Reset is automatic upon correction of an undervoltage fault.

Reset: Removing input voltage resets the output relay and the time delays.

Accessories

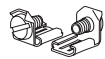

Quick connect to screw adaptor
P/N: **P1015-18**



Female quick connect P/Ns:
P1015-64 (AWG 14/16)
P1015-13 (AWG 10/12)



Mounting bracket
P/N: **P1023-6**

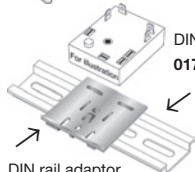

DIN rail P/Ns:
017322005 (Steel)
C103PM (Al)

DIN rail adaptor
P/N: **P1023-20**

See accessory pages for specifications.

HLV
Series

A

X

Undervoltage Range
4 - 70 ... 120 VAC
6 - 170 ... 220 VAC

X

Output Connection
I = Isolated SPDT
N = Non-Isolated SPDT

X

Restart Delay
2 - Onboard Adjustment
3...300 s

X

Trip Delay
Fixed 1 ... 20 s in
1 s increments

Example P/N's: **HLVA4N25** = 70 ... 120 VAC Trip Point Range, Non-Isolated SPDT, Adjustable Restart Delay, Trip Delay fixed at 5 seconds
HLVA6I220 = 170 ... 220 V Trip Point Range, Isolated SPDT, Adjustable Restart Delay, Trip Delay fixed at 20 seconds

Single Phase Undervoltage Monitor

HLV Series

30 A SPDT Relay Output

Voltage
Monitors

Technical Data

Input		
Min and Max RMS Voltage		70 ... 264 VAC
Line Frequency		50 ... 60 Hz
Power Consumption		AC ≤ 4 VA
Undervoltage Sensing		
Type		Peak Voltage Sensing
Ranges	(4)	70 ... 120 VAC
	(6)	170 ... 220 VAC
Pull-In Voltage		105% or Trip Point Voltage
Trip Point Accuracy		± 3% of Trip Point
Time Delay		
Restart Delays		3 ... 300 s adjustable
Trip Delay		1 ... 20 s fixed in 1 s increments
Repeat Accuracy		+/-0.5% or 20 ms, whichever is greater
Tolerance (Factory Calibration)		+/-5%
Reset Time		≤ 150 ms
Time Delay vs. Temp. & Voltage		≤ +/-10%
Output		
Type/Form		Electromechanical relay/SPDT
Ratings:		
		SPDT-N.O SPDT-N.C.
General Purpose	125/240 V AC	30 A 15 A
Resistive	125/240 V AC	30 A 15 A
	28 V DC	20 A 10 A
Motor Load	125 V AC	1 hp* 1/4 hp**
	240 V AC	2 hp** 1 hp**
Life		Mechanical -- 1 x 10 ⁶ Electrical -- 1 x 10 ⁵ , *3 x 10 ⁴ , **6,000
Protection		
Surge		IEEE C62.41-1991 Level A
Circuitry		Encapsulated
Isolation Voltage		≥ 1500 V RMS input to output; isolated units
Insulation Resistance		≥ 100 MΩ
Mechanical		
Mounting		Surface mt. with one #10 (M5 x 0.8) screw
Package		3 x 2 x 1.5 in. (76.7 x 51.3 x 38.1 mm)
Termination		0.25 in. (6.35 mm) male quick connects
Environmental		
Operating Temp.		-40°C ... +60°C
Storage Temp.		-40°C ... +85°C
Humidity		95% relative, non-condensing
Weight		≅ 3.9 oz (111 g)

7

Mechanical View

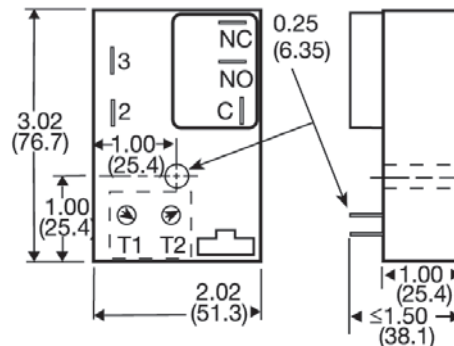

T1 = Undervoltage Trip Point
T2 = Restarty Delay

Inches (Millimeters)

HLV02B01 02.10.06

KVM Series Single Phase Undervoltage Monitor



10 YEAR WARRANTY

- Economical Single Phase Brownout/Undervoltage Protection
- Isolated 8 A SPDT Relay Contacts
- Input Voltages of 0 to 132 or 0 to 264 V AC
- Adjustable Low Voltage Trip Point
- LED Indicator

Approvals:

Description

The KVM Series is a single phase undervoltage monitor designed to protect sensitive equipment against brownout undervoltage conditions. The compact design and encapsulated construction make the KVM an excellent choice for OEM equipment.

Operation

The output relay is energized and the LED glows green when the input voltage is above the reset voltage threshold. If the input voltage drops below the undervoltage set point, the output relay and LED will de-energize. The output relay will remain de-energized as long as the input voltage is below the reset voltage. Reset is automatic when the input voltage returns to a normal range.

Connection

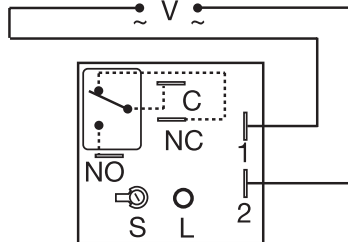

V = Voltage L = LED S = Undervoltage Set Point
 NO = Normally Open NC = Normally Closed
 C = Common, Transfer Contact
 Dashed lines are internal connections.

Function

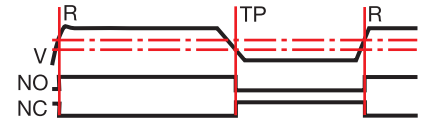

TP = Undervoltage Set Point R = Reset Point

Mechanical View

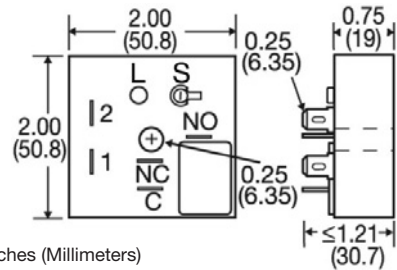

Accessories

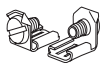

Quick connect to screw adaptor
 P/N: **P1015-18**



Female quick connect
 P/N: **P1015-64** (AWG 14/16)

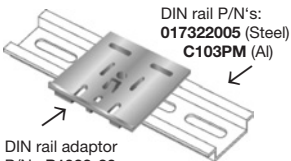

DIN rail P/N's:
017322005 (Steel)
C103PM (Al)

DIN rail adaptor
 P/N: **P1023-20**

See accessory pages for specifications.

Undervoltage Set Point (Adjustable)

78 ... 99 V AC
 156 ... 199 V AC

Maximum Line Voltage

132 V AC
 264 V AC

Part Number

KVM4
 KVM6

Technical Data

Line Voltage

Type
 Input Voltage/Frequency
 Power Consumption
 Power Off Reset Time

Single Phase
 110 ... 120 V AC or 208 ... 240 V AC/50 ... 60 Hz
 2.5W at 132 V AC; 4.5W at 264 V AC
 ≤ 150 ms

Undervoltage Detection

Undervoltage Set Point
 Undervoltage Reset Point
 Repeatability

KVM4
 KVM6
 KVM4
 KVM6
 78 ... 99 V AC
 156 ... 199 V AC
 Fixed at 104 V AC
 Fixed at 209 V AC
 +/- 0.5% under fixed conditions
 +/-1% over temperature range
 +/-2% at 25°C

Voltage Sensing Accuracy

Output

Type/Form
 Rating
 Life
 LED Indicator

Electromechanical Relay/SPDT
 8 A resistive at 120 V AC, 1/3 hp at 120/240 V AC
 Mechanical; 1 x 10⁵; Electrical; 1x10⁵
 Glows green when output energized

Protection

Surge
 Circuitry
 Isolation Voltage
 Insulation Resistance

IEEE C62.41-1991 Level A
 Encapsulated
 ≥ 1500 V RMS Input to Output
 ≥ 100 MΩ Minimum

Mechanical

Mounting
 Package
 Termination

Surface mount with one #10 (M5 x 0.8) screw
 2 x 2 x 1.21 in. (50.8 x 50.8 x 30.7 mm)
 0.25 in. (6.35 mm) male quick connect terminals

Environmental

Operating/Storage Temperature
 Humidity
 Weight

-25 to +55°C/-40 to +85°C
 95% relative, non-condensing
 2.6 oz (74 g)

