



NEW DIGITAL FIBER SENSOR

FX-500_{SERIES}



**At the industry's
leading edge**

FX-SERIES HIGH END MODEL



Stability

Industry leading stability

Decrease the variation among fiber sensors

High stability!

“Why are the values different even for the same detection?” “If we try to forcibly unify all the display values of incident light intensity, we will not be able to read the actual changes.”

SUNX focuses on the variation among fiber sensors and aims for absolute digitalization.

When the **FX-500** series is used together with our super quality fiber, the incident light intensity variation among units is decreased to only 1/4 of that of conventional models.

By being close to absolute values instead of modified digital values, changes in detection that could not be found in the past can now be monitored.

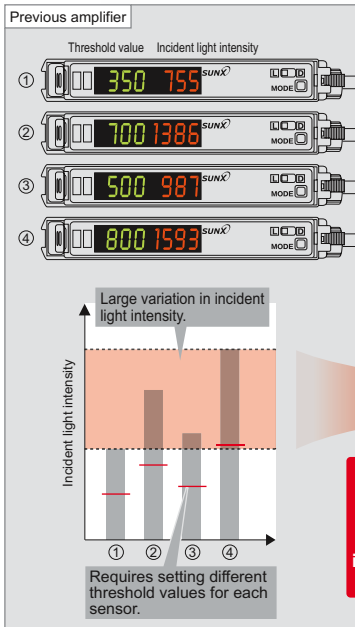
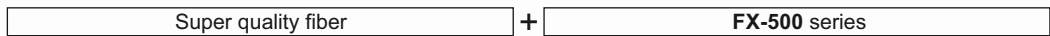

Digital control is essentially achieved

Stability of the incident light intensity is improved by 4 times*. Values of incident light intensity stay close together even after replacing an amplifier.

* Using a small diameter fiber (fiber core ø0.5 mm ø0.020 in). If using a standard fiber (fiber core ø1.0 mm ø0.039 in), the variation will be double of that of conventional models.



Specifying just one value in an operation manual is possible

In the case where multiple fiber sensors are installed under the same operating conditions, the incident light intensities are nearly identical to each other, allowing for the specification of one threshold across all sensors.

Maintenance is easy on stabilized fiber sensors

Because the incident light intensity is stable, the same threshold value can be used even when an amplifier is replaced. Also, copying of settings is easy when used together with optical communication.

Stability in incident light intensity and confidence in beam adjustment

When setting up fiber sensors in a row in the same layout, all incident light intensities will display nearly identical values once beams are aligned. This helps to raise installation precision and prevent trouble from occurring before equipment is turned on.

Improved fiber coupling efficiency and suppressed variation among units

In each unit we have accurately aligned the central axis of the fiber with the central axis of the emitted light, which creates a high coupling efficiency that helps to reduce variation among units.

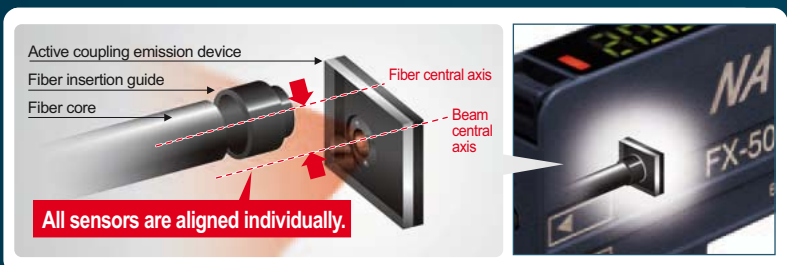

* Illustration is an image.

"Super quality fiber" with stable emission amount

"Stabilized incident light intensities" even in multiple units

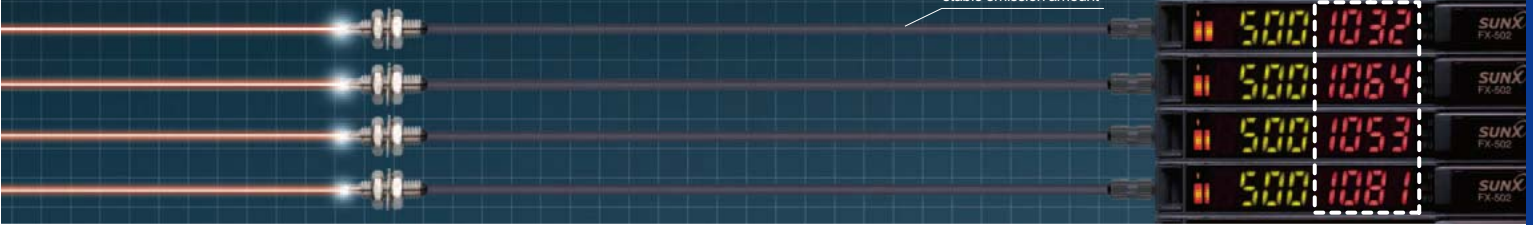

A quality that surpassed standard fiber

Introducing super quality fiber



New fibers developed using a new manufacturing method adopted by our own factory along with a persistent quality control system

The basic performance of a standard fiber is greatly enhanced!

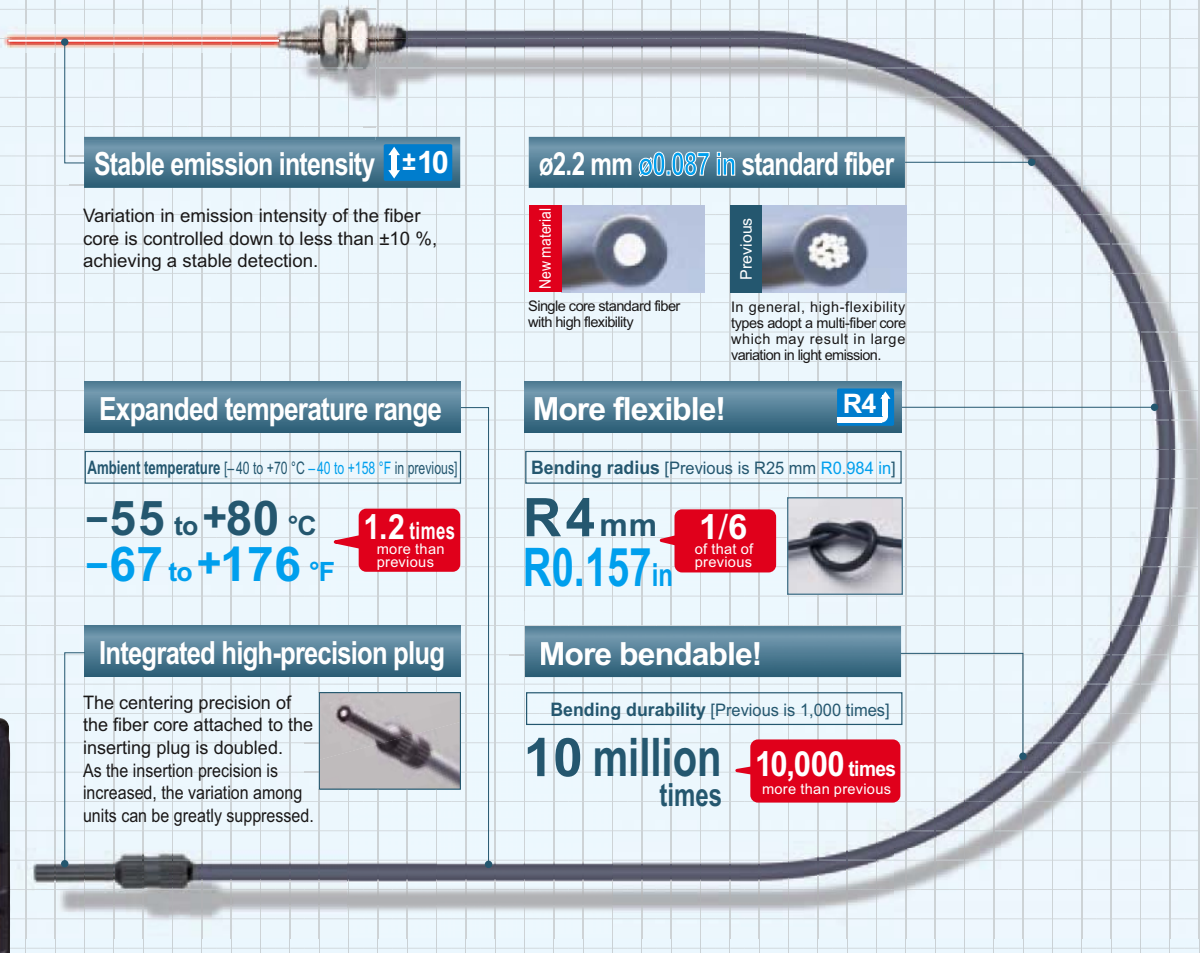

$\updownarrow \pm 10$

Variation in emission intensity is down to less than $\pm 10\%$

Under our new manufacturing method and quality control system, we have developed fiber heads that have a stabilized light emission. When used with the FX-500 amplifier, a complete digital control is essentially achieved.

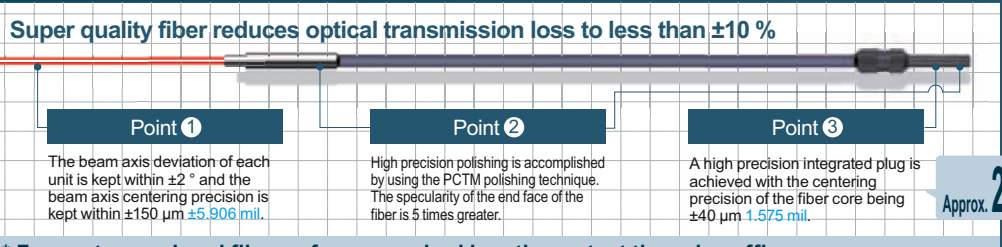

* For custom-ordered fibers of your required length, contact the sales office near you.

Speed & Distance

Industry leading sensing performance

Ultra high-speed & Ultra long range detection

The exclusive detection IC combined with the high intensity beam emitted from the active coupling emission device provides the capability of offering high-speed response time over a longer sensing range, opening up new possibilities for fiber sensor detection.

Max. 25 μ s response time

FX-500 with its ultra high response time improves productivity.



Performing minute object detection when using a small diameter fiber is now possible with a high response time and longer sensing range.

Hyper HYPR mode incorporated

FX-500 in combination with small diameter fibers which can handle challenging detections, allows super long sensing range.

Max. **5.6** times! (Note)
longer than the previous model



Note: When using FD-NFM2.

Long sensing range with small diameter fibers

Small diameter fibers with a compact head can perform long range and stable detection for minute objects.

Long sensing range even in high speed mode

A high speed response time of 25 μ s, which is 2.6 times more than previous, and a long sensing range are now possible in high speed mode.

Satisfying both high speed and long range

The active coupling emission device efficiently focuses the beam through small diameter fibers

A super fine optical lens and emitting element are combined into one device enabling the beam emitted from the emitting element to be focused directly into the fiber. Coupling efficiency is therefore increased by 50 % of that of standard fiber (core ϕ 1 mm ϕ 0.039 in). In particular, the small diameter fibers (core ϕ 0.5 mm ϕ 0.020 in) see a dramatic increase in light intensity, making challenging detections possible.

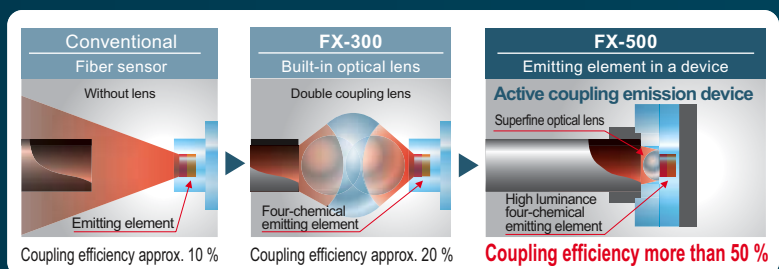

Coupling efficiency = (light intensity directed into the fiber / emission intensity of active coupling emission device) \times 100 * Illustration is an image.



Sharp detection with suppressed hysteresis

A different accuracy!

FX-500 with its accurate detection catches fractional difference in light intensity, fulfilling high precision and low-hysteresis applications.

H-02 mode

Long range detection of small objects with small difference in light intensity

FX-500 series achieves a long sensing range by its suppressed hysteresis and high intensity beam. Detection of minute objects over a long range is now more accurate compared to the past.

Comparison image of optimal sensing region

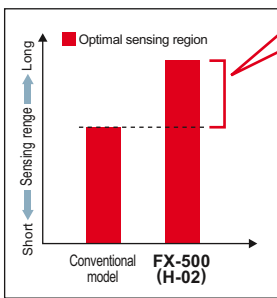

Long range detection of a glass target is now possible due to the ability of the sensor to detect small changes in light intensity.

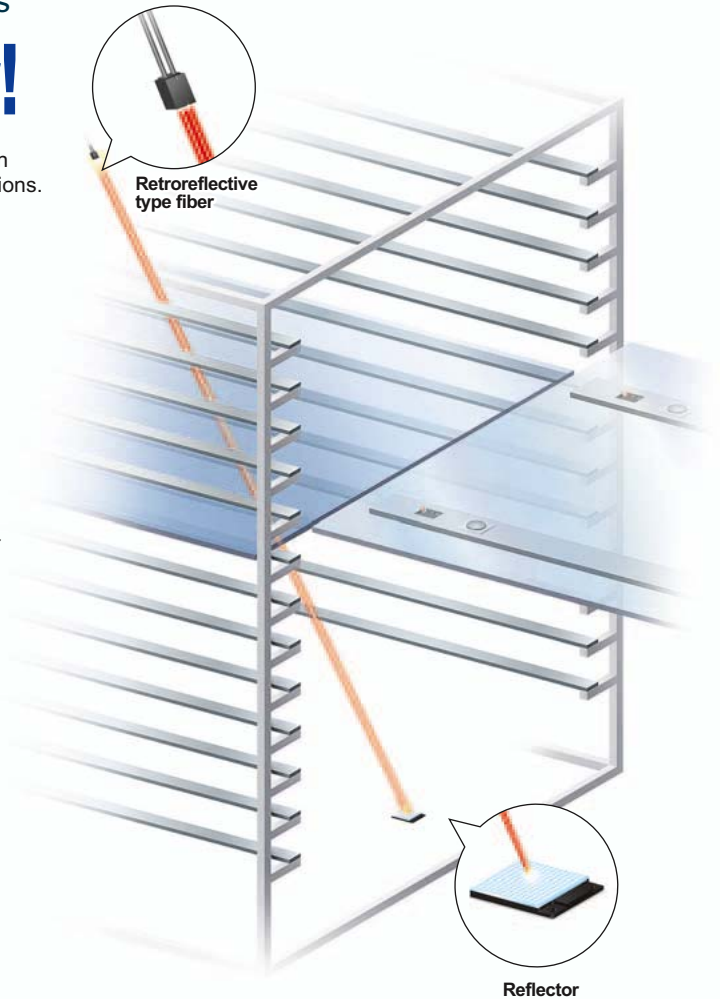

H-01 mode

Highly accurate detection while avoiding saturation

Even when the received light becomes saturated, the FX-500 series cuts down hysteresis to the utmost limit in order to produce the optimal margin for detection.

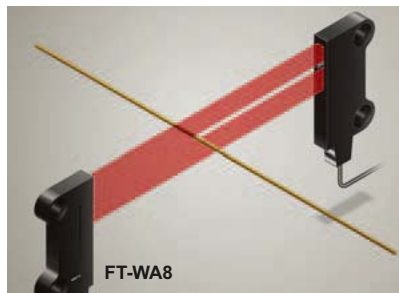

Comparison image of optimal sensing region

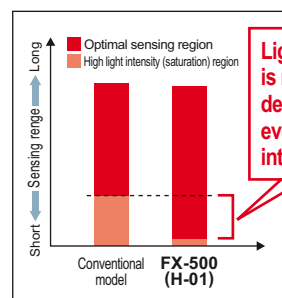

Light saturated region is reduced, and detection is possible even under high light intensity.

Three hysteresis modes

Hysteresis is the difference in incident light intensity at the points when the output turns ON and when the output turns OFF. Hysteresis was originally intended to be used as a measure against vibrations, but SUNX provides three hysteresis modes to suit the need of fiber sensors.

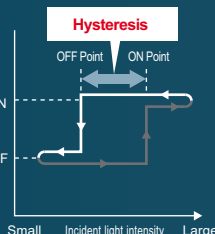

Mode table

Mode	Hysteresis amount	Light intensity	Description
H-01	Minimal	Small	Sharp detection with high accuracy is possible in this mode. Optimal for minute object detection where light saturates easily.
H-02	Small	Large	Initial setting mode. Accurate detection such as long range detection of a large glass substrate is possible.
H-03	Large	Large	A mode used for chattering prevention. Works in adverse environments such as vibration or dirt.

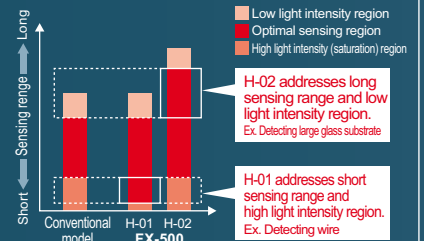

H-02 addresses long sensing range and low light intensity region. Ex. Detecting large glass substrate

H-01 addresses short sensing range and high light intensity region. Ex. Detecting wire

Class leading form and operability

New form!

Flat display with wide viewing angle

The large and high-contrast 7-segment display of high luminance provides clear visibility from a wide angle of view.

Clearly visible even from sideways

Compact cover does not get in the way
Reduced to **1/3** of that of previous

R23 mm
R0.906 in



Streamlined fiber clutch

While the conventional fiber installation is done after opening up the cover, the FX-500 series adopts a guard structure, eliminating the cover so that the fiber installation can be done in one step.

MODE NAVI + Direct setting

MODE NAVI uses three indicators and a dual display to show the amplifier's basic operations. The current operation mode can be confirmed at a glance, so even a first time user can easily operate the amplifier.

Streamlined fiber clutch

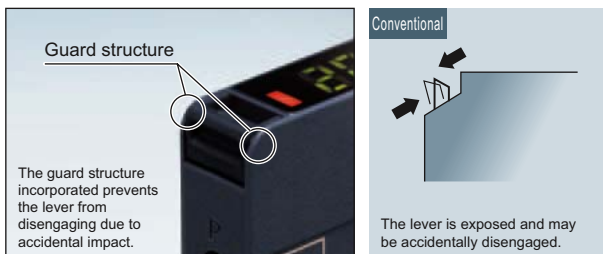
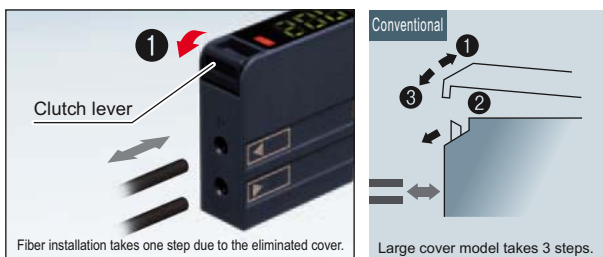

NAVI display (lights out during RUN mode)

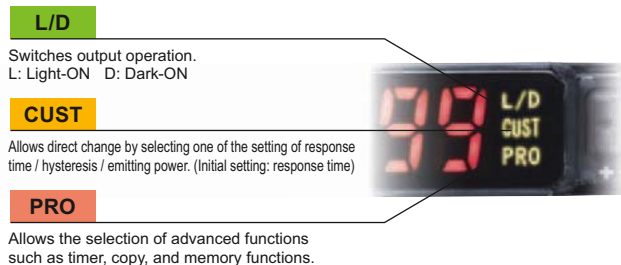

Direct setting



A variety of functions at the industry's leading edge

Resolves variation in incident light intensity display

Display adjustment setting

Even if there is no problem in detection, the variation in display may make it difficult for an operator to verify proper operation. By using the display adjustment setting, random values can be adjusted, and the visual variation can be resolved to help define proper operation in an operation manual.

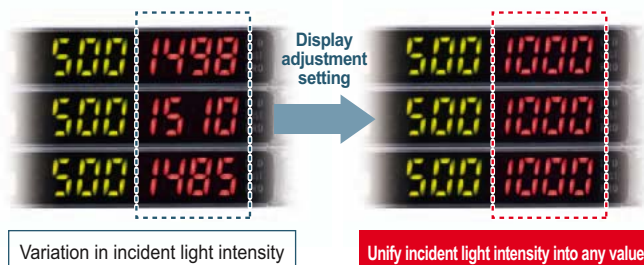

Stable detection over long and short periods

Stabilized emission intensity

The "four-chemical emitting element" was first incorporated in the conventional model FX-300 to maintain a stable level of light emission and has now become an industry standard. FX-500 series continues to adopt the same emitting element as well as the "APC (Auto Power Control) circuit" which improves stability in short periods such as when the power is turned on.

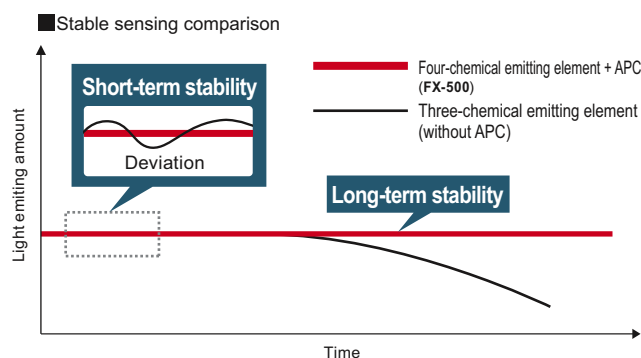

Saves maintenance time

Threshold tracking function

This function seeks changes in the light emitting amount resulting from changes in the environment over long periods (such as dust levels), so that the incident light intensity can be checked at desired intervals and the threshold values can be reset automatically.

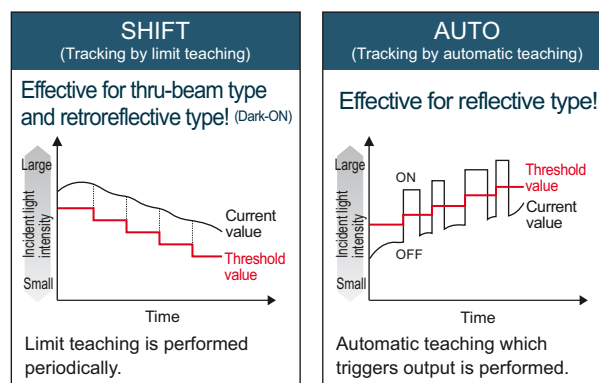

Suitable for preventative maintenance

Self-diagnosis output

FX-502(P) / 505(P)-C2 can set Output 2 as self-diagnosis output. When Output 1's threshold value teaching is carried out, Output 2 is set concurrently with the setting randomly shifted by the amount of surplus of threshold value.

■ Detect drops in light intensity (e.g. used in dusty environment)



Self-diagnosis can be used with the threshold tracking function for added effectiveness.

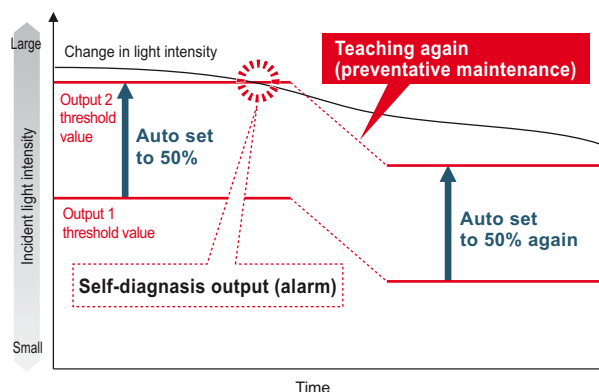

A variety of functions at the industry's leading edge

Stable detection while being eco-friendly

Emission power & gain setting



For cases when the incident light intensity saturates the receiver, the light intensity can be attenuated to the optimal level by AUTO without changing the response time. This allows for stable detection while maintaining an optimal S/N ratio and saves energy by controlling the emitting electric current.

Detecting a transparent sheet

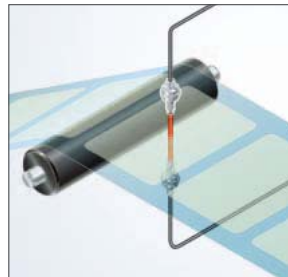

Object present

Object absent

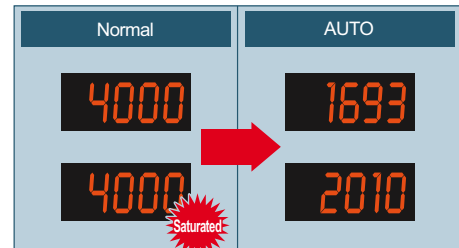

Auto mode (AUTO) and 3-level manual mode (3 levels: H / M / L [adjustable]) are incorporated.

Built-in logic functions

No PLC necessary saving material and programming costs

Logical calculation functions

Three logical calculations (AND, OR, XOR), are selectable using Output 1 of multiple FX-500 series amplifiers. A PLC is not required which helps to reduce material and programming and costs.

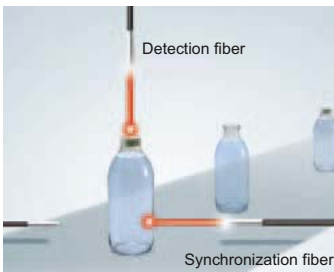

Calculation of two neighboring amplifiers

Lower side Output 1 Calculation result output
Upper side Output 1 Normal operation

Calculation of two outputs in one amplifier FX-502(P) / 505(P)-C2

Output 1 Calculation result output
Output 2 Normal output operation

Calculation of one amplifier and external input FX-502(P) / 505(P)-C2

External input (sensor, contact, PLC, etc.)
Output 1 Calculation result output

Equipped with 5 types timers

A wide variety of timer control operations can be carried out by these fiber sensors alone.

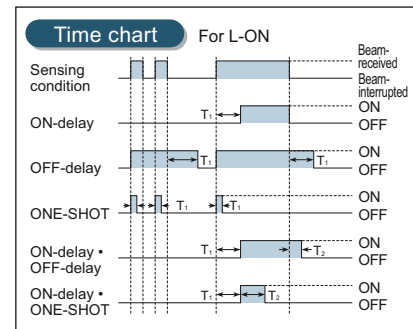

Timer period: 0.05 ms to 32 s
Output 1 has ON-delay • OFF-delay and ON-delay • ONE-SHOT timers.

Analog control is possible

Analog output cable type FX-505(P)-C2

A 4 to 20 mA analog output represents the digital value of incident light intensity

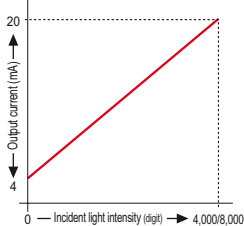

Edge tracking of film or sheet

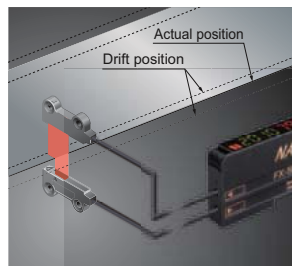

Drifting path can be tracked as the light intensity changes.

8 data banks

Smooth setup changes

The number of data banks used for saving the setup conditions of the amplifier is increased to eight. Setup conditions can be saved and loaded to make setup changes easy at worksite that manufactures multiple models.

External input

Remote control improves work efficiency FX-502(P) / 505(P)-C2

Work efficiency can be improved by operating via a PLC output or other external signal.

Functions operable by external input

Full-auto / Limit / 2-point teaching	Display adjustment setting
Data bank load / save	Logical calculation (self-unit only)
Emission halt	Copying function lock (self-unit only)



Selectable interference prevention

In addition to the automatic interference prevention function which is enabled through the optical communication of cascade connected amplifiers, an alternate frequency interference prevention function is also incorporated. So even for layouts where optical communication cannot be carried out, switching of emission frequencies allows interference prevention.

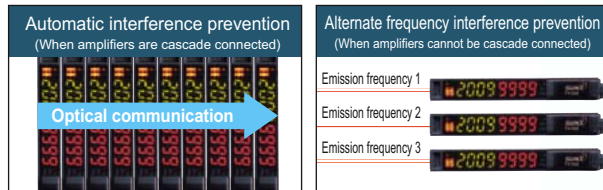

* Refer to specifications for details of number of sensors allowed in interference prevention.

An optical communication function allows sensors to be adjusted simultaneously

The optical communication function allows the data that is currently set to be copied and saved all at once for all amplifiers connected together from the right side. This greatly reduces troublesome setup tasks and makes setup much smoother.



No need to specify a main unit or sub unit

All FX-500 amplifiers can be used as either a main unit or a sub unit. Just use a main cable or a sub cable to distinguish the two. This reduces the costs of inventory management.

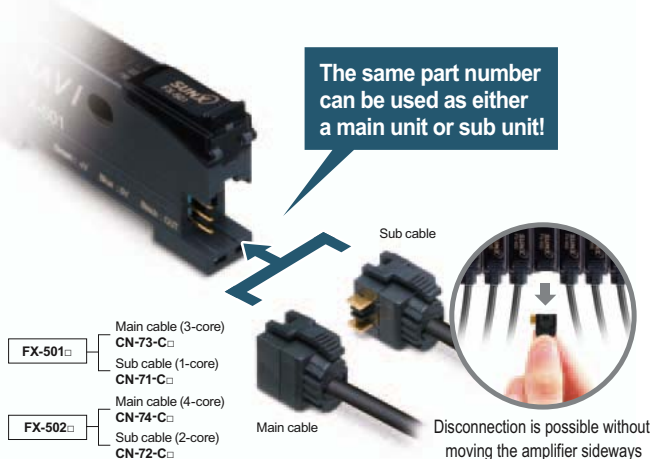

Wire-saving, space-saving

The quick-connection cables enable reduction in wiring. The connections and man-hours required for the relay terminal block setup can be reduced and valuable space is saved.

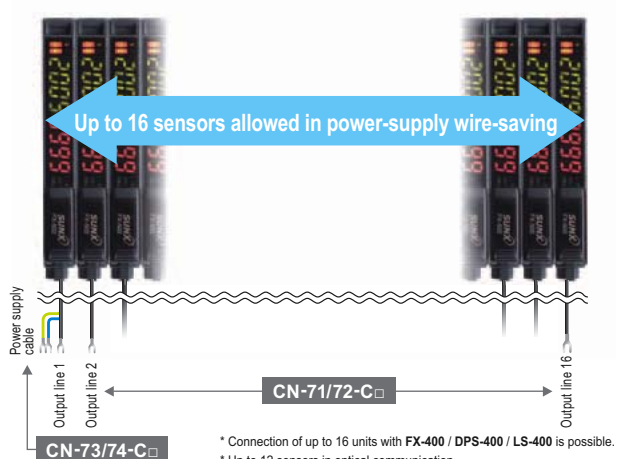

PRO mode functions



PRO1	Response time setting
	Timer setting
	Hysteresis setting
	Shift amount setting
	Emission power setting
PRO2	Timer range setting
	Teaching lock setting
	Digital display item setting
	Digital display turning on setting
	ECO setting
PRO3	Period hold setting
	Data bank loading setting
	Data bank saving setting
	Back up setting
PRO4	Input / output setting ^{*1}
	Copy setting
	Copy action setting
	Copy lock setting
	Communication protocol setting
	External input setting ^{*2}

PRO5	Code setting	
	Display adjustment setting	
	Reset setting	
	CUSTOM setting	
	Interference prevention setting	
PRO6	Sensing output mode	Normal mode
		Window comparator mode ^{*3}
		Rising differential mode
		Trailing differential mode
		Hysteresis mode
		Forced ON output mode
		Forced OFF output mode
		Self-diagnosis output mode ^{*4}
Answer back output mode ^{*5}		
PRO7	Setting of threshold value tracking	Logical operation setting ^{*6}
		Setting of threshold tracking
		Sensing output setting
		Algorithm setting

*1: FX-502(P) only *2: FX-502(P) and FX-505(P)-C2 only *3: Output 1 only
 *4: Output 2 only of FX-502(P) and FX-505(P)-C2 *5: Output 2 only of FX-505(P)-C2
 *6: FX-501(P) can do a part of operations.

ORDER GUIDE

Amplifiers Quick-connection cable is not supplied with **FX-501(P)** and **FX-502(P)**. Please order it separately.

Type	Appearance	Model No.	Emitting element	Output	External input
Standard type		FX-501	Red LED	NPN open-collector transistor	_____
		FX-501P		PNP open-collector transistor	
2-output type		FX-502		NPN open-collector transistor 2 outputs	Incorporated Switchable with Output 2
		FX-502P		PNP open-collector transistor 2 outputs	
Cable type		FX-505-C2		NPN open-collector transistor 2 outputs analog output	Incorporated
		FX-505P-C2		PNP open-collector transistor 2 outputs analog output	

Quick-connection cables

For FX-501(P) Quick-connection cable is not supplied with the amplifier. Please order it separately.

Type	Model No.	Description	
Main cable (3-core)	CN-73-C1	Length: 1 m 3.281 ft	0.15 mm ² 3-core cabtyre cable, with connector on one end Cable outer diameter: ø3.0 mm ø0.118 in
	CN-73-C2	Length: 2 m 6.562 ft	
	CN-73-C5	Length: 5 m 16.404 ft	
Sub cable (1-core)	CN-71-C1	Length: 1 m 3.281 ft	0.15 mm ² 1-core cabtyre cable, with connector on one end Cable outer diameter: ø3.0 mm ø0.118 in
	CN-71-C2	Length: 2 m 6.562 ft	
	CN-71-C5	Length: 5 m 16.404 ft	

Main cable

- **CN-73-C□**

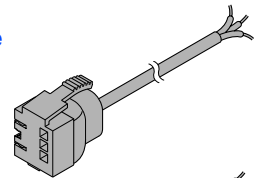

Sub cable

- **CN-71-C□**

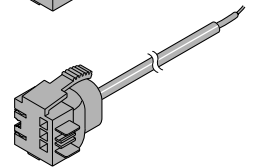

For FX-502(P) Quick-connection cable is not supplied with the amplifier. Please order it separately.

Type	Model No.	Description	
Main cable (4-core)	CN-74-C1	Length: 1 m 3.281 ft	0.15 mm ² 4-core cabtyre cable, with connector on one end Cable outer diameter: ø3.0 mm ø0.118 in
	CN-74-C2	Length: 2 m 6.562 ft	
	CN-74-C5	Length: 5 m 16.404 ft	
Sub cable (2-core)	CN-72-C1	Length: 1 m 3.281 ft	0.15 mm ² 2-core cabtyre cable, with connector on one end Cable outer diameter: ø3.0 mm ø0.118 in
	CN-72-C2	Length: 2 m 6.562 ft	
	CN-72-C5	Length: 5 m 16.404 ft	

Main cable

- **CN-74-C□**

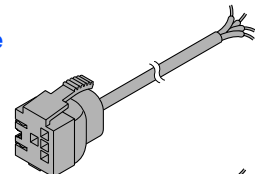

Sub cable

- **CN-72-C□**

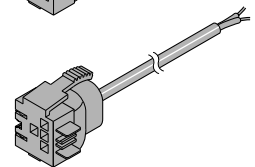

End plates End plates are not supplied with the amplifier. Please order them separately when the amplifiers are mounted in cascade.

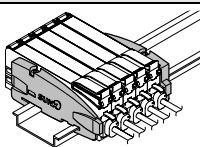
Appearance	Model No.	Description
	MS-DIN-E	When cascading multiple amplifiers, or when it moves depending on the way it is installed on a DIN rail, these end plates clamp amplifiers into place on both sides. Make sure to use end plates when cascading multiple amplifiers together. Two pcs. per set

OPTIONS

Amplifier mounting bracket

- **MS-DIN-2**

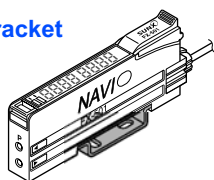

Amplifier protection seal

- **FX-MB1**
10 sets of 2 communication window seals and 1 connector seal

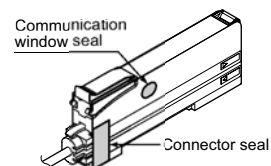

SPECIFICATIONS

Item	Model No.	Type	Standard type	2-output type	Cable type
		NPN output	FX-501	FX-502	FX-505-C2
		PNP output	FX-501P	FX-502P	FX-505P-C2
Supply voltage		12 to 24 V DC \pm 10 % Ripple P-P 10 % or less			
Power consumption		Normal operation: 960 mW or less (current consumption 40 mA or less at 24 V supply voltage, excluding analog output of cable type) ECO mode: 680 mW or less (current consumption 28 mA or less at 24 V supply voltage, excluding analog output of cable type)			
Output (2-output type and cable type: Output 1, Output 2)	<NPN output type> NPN open-collector transistor		<PNP output type> PNP open-collector transistor		
	<ul style="list-style-type: none"> Maximum sink current: 100 mA (2-output type and cable type are 50 mA) (Note 2) Applied voltage: 30 V DC or less (between output and 0 V) Residual voltage: 2 V or less (Note 3) (at maximum sink current) 		<ul style="list-style-type: none"> Maximum source current: 100 mA (2-output type and cable type are 50 mA) (Note 2) Applied voltage: 30 V DC or less (between output and +V) Residual voltage: 2 V or less (Note 3) (at maximum source current) 		
	Output points	1 point	2 points		
	Output operation	Switchable either Light-ON or Dark-ON by L/D mode			
Short-circuit protection		Incorporated			
Response time		H-SP: 25 μ s or less, FAST: 60 μ s or less, STD: 250 μ s or less, LONG: 2 ms or less, U-LG: 4 ms or less, HYPR: 24 ms or less, selectable			
Analog output (Cable type only)		Output current: 4 to 20 mA approx. [H-SP, FAST STD: At 0 to 4,000 digits, LONG: At 0 to 8,000 digits (Note 4)], Response time: 2 ms or less, Zero point: Within 4 mA \pm 1 % F.S., Span: Within 16 mA \pm 5 % F.S., Linearity: Within \pm 3 % F.S., Load resistance: 0 to 250 Ω			
External input (2-output type only, switchable with Output 2)		—————	<NPN output type> NPN non-contact input	<PNP output type> PNP non-contact input	
Possible external input function		—————	<ul style="list-style-type: none"> Signal condition High: +8 V to +V DC or Open Low: 0 to +1.2 V DC (at 0.5 mA source current) Input impedance: 10 kΩ approx. 	<ul style="list-style-type: none"> Signal condition High: +4 V to +V DC (at 3 mA sink current) Low: 0 to +0.6 V DC or Open Input impedance: 10 kΩ approx. 	
Sensitivity setting		2-point teaching / Limit teaching / Full-auto teaching / Manual adjustment			
Incident light intensity display range		H-SP / FAST / STD: 0 to 4,000, LONG: 0 to 8,000, U-LG / HYPR: 0 to 9,999			
Timer function		Incorporated with variable OFF-delay / ON-delay / ONE SHOT / ON-delay • OFF-delay / ON-delay • ONE SHOT timer, switchable either effective or ineffective	<Output 1> Incorporated with variable OFF-delay / ON-delay / ONE SHOT / ON-delay • OFF-delay / ON-delay • ONE SHOT timer, switchable either effective or ineffective		
Timer period		Timer range "ms": 0.5 ms approx., 1 to 9,999 ms approx., 1 ms approx., Timer range "sec.": 0.5 s approx., 1 to 32 s approx., 1 s approx., Timer range "1/10 ms": 0.05 ms approx., 0.1 to 999.9 ms approx., 0.1 ms approx., each output is set individually			
Light emitting amount selection function		Incorporated, 3 levels (each level 25 to 100 %) + Auto setting [1 level (25 to 100 %) when using H-SP mode]			
Interference prevention function		Incorporated (Note 5), selectable either automatic interference prevention or different frequency			
Various settings		Hysteresis setting / Shift amount setting / Emission power setting / Display turning setting / ECO setting / Data bank loading saving setting / Copying setting / Code setting / Reset setting / Logical calculation setting / Threshold tracking setting, etc.			
Protection		IP40 (IEC)			
Ambient temperature		-10 to +55 °C +14 to +131 °F [If 4 to 7 units are mounted in cascade: -10 to +50 °C +14 to +122 °F or if 8 to 16 units (cable type: 8 to 12 units) are mounted in cascade: -10 to +45 °C +14 to +113 °F] (No dew condensation or icing allowed), Storage: -20 to +70 °C -4 to +158 °F			
Emitting element (modulated)		Red LED (Peak emission wavelength: 650 nm 0.026 mil)			
Material		Enclosure: Heat-resistant ABS (Cable type: Polycarbonate), Case cover: Polycarbonate, Switch: TPEE			
Cable		—————	0.2 mm ² 6-core cabtyre cable, 2 m 6.562 ft long		
Cable extension		—————	Extension up to total 100 m 328.084 ft is possible with 0.3 mm ² , or more, cable. (however, supply voltage 12 V DC)		
Weight		Net weight: 15 g approx., Gross weight: 70 g approx.		Net weight: 60 g approx., Gross weight: 100 g approx.	
Accessory		FX-MB1 (Amplifier protection seal): 1 set			

- Notes: 1) Where measurement conditions have not been specified precisely, the conditions used were an ambient temperature of +23 °C **+73.4 °F**.
 2) 50 mA max. if 5 or more standard types are connected together. (25 mA in case of 2-output type)
 3) In case of using the quick-connection cable (cable length 5 m **16.404 ft**) (optional).
 4) If display adjustment was conducted, it is not in this range.
 5) Number of sensor heads which is possible to be mounted closely in auto interference prevention function depends on response time as shown in table below.
 Number of sensor heads which is possible to be mounted closely in different frequency Interference prevention function is up to 3 units.

• Number of sensor heads mountable closely (Unit: set)

Response time	H-SP	FAST	STD	LONG	U-LG	HYPR
IP-1	0	2	4	8	8	12

I/O CIRCUIT AND WIRING DIAGRAMS

FX-501

NPN output type

I/O circuit diagram

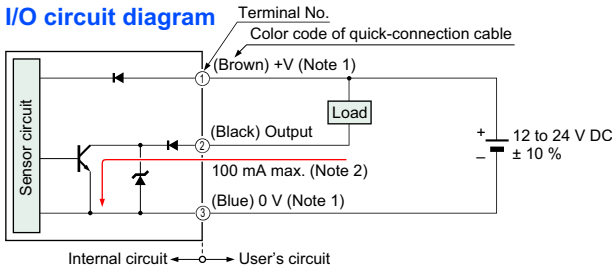

Notes: 1) The quick-connection sub cable does not have +V (brown) and 0 V (blue). The power is supplied from the connector of the main cable.
2) 50 mA max., if five amplifiers, or more, are connected together.

Wiring diagram

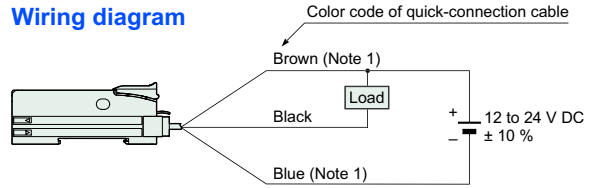

Note: The quick-connection sub cable does not have brown lead wire and blue lead wire.

Terminal arrangement diagram

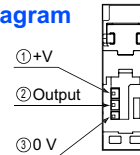

FX-501P

PNP output type

I/O circuit diagram

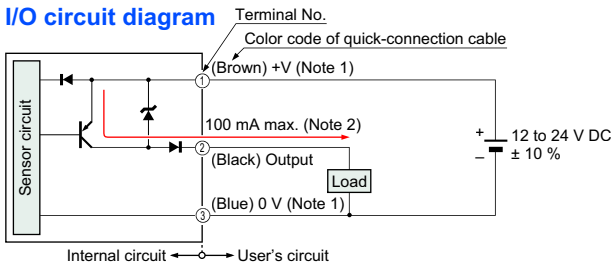

Notes: 1) The quick-connection sub cable does not have +V (brown) and 0 V (blue). The power is supplied from the connector of the main cable.
2) 50 mA max., if five amplifiers, or more, are connected together.

Wiring diagram

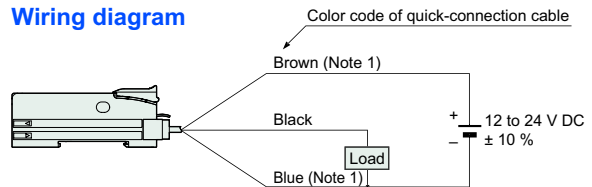

Note: The quick-connection sub cable does not have brown lead wire and blue lead wire.

Terminal arrangement diagram

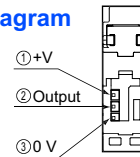

FX-502

NPN output type

I/O circuit diagram

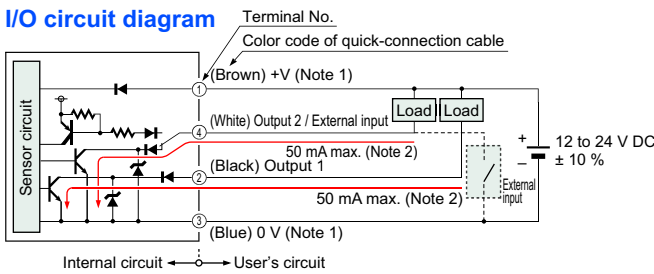

Notes: 1) The quick-connection sub cable does not have +V (brown) and 0 V (blue). The power is supplied from the connector of the main cable.
2) 25 mA max., if five amplifiers, or more, are connected together.

Wiring diagram

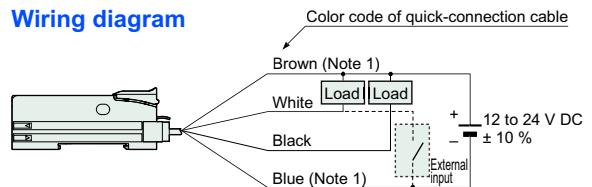

Note: The quick-connection sub cable does not have brown lead wire and blue lead wire.

Terminal arrangement diagram

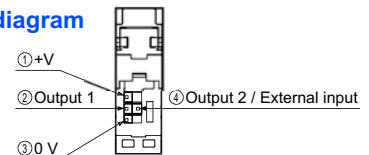

FX-502P

PNP output type

I/O circuit diagram

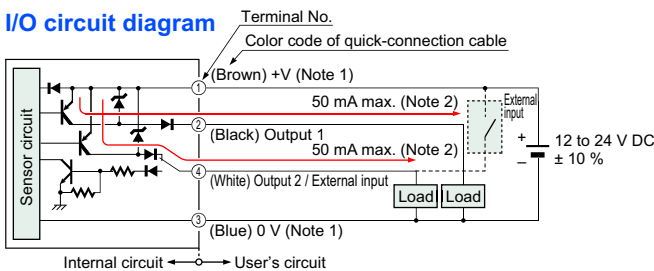

Notes: 1) The quick-connection sub cable does not have +V (brown) and 0 V (blue). The power is supplied from the connector of the main cable.
2) 25 mA max., if five amplifiers, or more, are connected together.

Wiring diagram

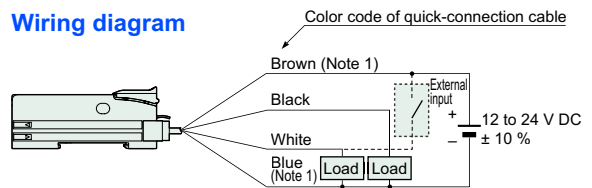

Note: The quick-connection sub cable does not have brown lead wire and blue lead wire.

Terminal arrangement diagram

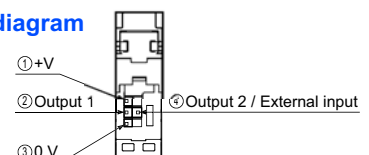

I/O CIRCUIT AND WIRING DIAGRAMS

FX-505-C2

NPN output type

I/O circuit diagram

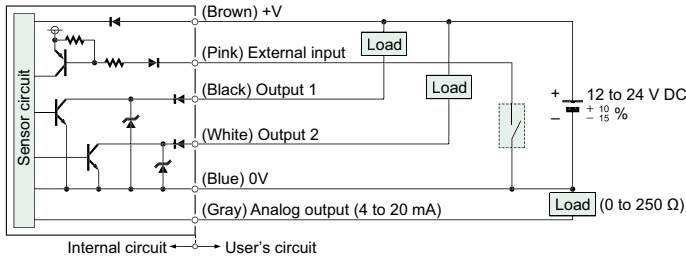

Wiring diagram

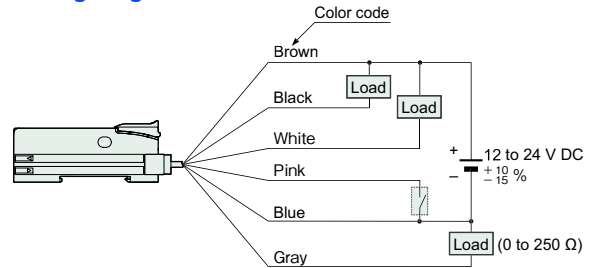

FX-505P-C2

PNP output type

I/O circuit diagram

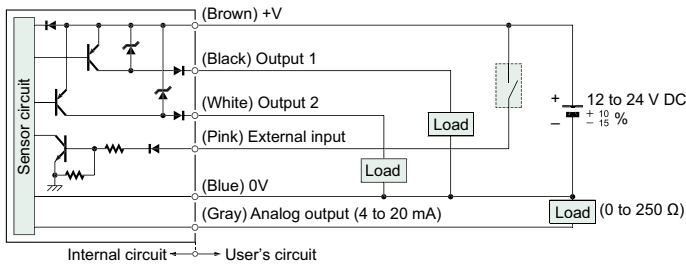

Wiring diagram

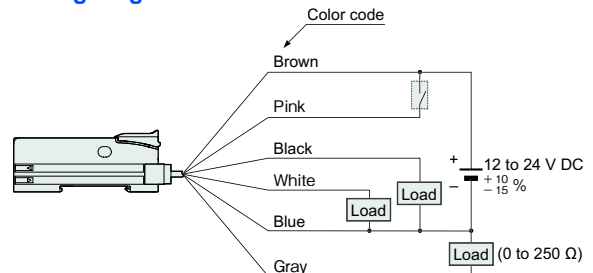

Super Quality Fibers

A quality that surpasses standard fiber

LIST OF SUPER QUALITY FIBERS

Thru-beam type (one pair set)



Type	Shape of fiber head (mm in)	Sensing range (mm in)			U-LG LONG FAST	Beam axis dia. (mm in)	Fiber cable length	Bending radius	Ambient temperature	Model No.
		■ : HYPR	■ : STD	■ : H-SP						
Threaded	M4	3,600 (Note) 141.732	1,200 47.244	190 7.480	U-LG: 2,200 86.614 LONG: 1,700 66.929 FAST: 530 20.866	ø1 ø0.039	2 m 6.562 ft	R4 mm R0.157 in Allowable bending radius	-55 to +80 °C -67 to +176 °F	FT-40
	M3	1,350 53.150	400 15.748	75 2.953	U-LG: 810 31.890 LONG: 650 25.591 FAST: 210 8.268	ø0.5 ø0.020				FT-30
Cylindrical	ø3 ø0.118	3,600 (Note) 141.732	1,200 47.244	190 7.480	U-LG: 2,200 86.614 LONG: 1,700 66.929 FAST: 530 20.866	ø1 ø0.039				FT-S30
	ø1.5 ø0.059	1,350 53.150	400 15.748	75 2.953	U-LG: 810 31.890 LONG: 650 25.591 FAST: 210 8.268	ø0.5 ø0.020				FT-S20

Note: The fiber cable length practically limits the sensing range to 3,600 mm 141.732 in long.

Reflective type

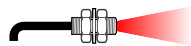

Type	Shape of fiber head (mm in)	Sensing range (mm in)			U-LG LONG FAST	Fiber cable length	Bending radius	Ambient temperature	Model No.
		■ : HYPR	■ : STD	■ : H-SP					
Threaded	M6	1,550 61.024	520 20.472	90 3.543	U-LG: 900 35.433 LONG: 740 29.134 FAST: 260 10.236	2 m 6.562 ft	R4 mm R0.157 in Allowable bending radius	-55 to +80 °C -67 to +176 °F	FD-60
	M4	600 23.622	160 6.299	25 0.984	U-LG: 330 12.992 LONG: 250 9.843 FAST: 80 3.150				FD-40
	M3	600 23.622	160 6.299	25 0.984	U-LG: 330 12.992 LONG: 250 9.843 FAST: 80 3.150				FD-30
Cylindrical	ø3 ø0.118	600 23.622	160 6.299	25 0.984	U-LG: 330 12.992 LONG: 250 9.843 FAST: 80 3.150				FD-S30

SUPER QUALITY FIBER SPECIFICATIONS

Item	Type	Thru-beam type	Reflective type
	Model No.	FT-40, FT-30, FT-S30, FT-S20	FD-60, FD-40, FD-30, FD-S30
Variation of fiber head		Within ±10 % (Note 2)	
Beam axis precision		Beam axis position: Within ±150 µm, Inclination of beam axis: Within ±2° (Note 3) Beam axis position: Within ±150 µm, Inclination of beam axis: Within ±3° (Note 3)	
Allowable bending radius		R4 mm R0.157 in or more	
Bending durability		10 million times or more (Note 4)	
Ambient temperature		-55 to +80 °C -67 to +176 °F (No dew condensation or icing allowed) (Note 5), Storage: -55 to +80 °C -67 to +176 °F	
Ambient humidity		35 to 85 % RH (Note 5), Storage: 35 to 85 % RH	
Material	Fiber core	Acrylic	
	Sheath	Polyethylene	
	Fiber head	Stainless steel (SUS303)	
	Plug	ABS	
Accessories		All fibers: FX-AT2 (fiber attachment) 1 pc. Threaded head fibers: Nuts 2 pcs. (Thru-beam type: 4 pcs.) and toothed lock washer 1 pc. (Thru-beam type: 2 pcs.)	

- Notes: 1) Where measurement conditions have not been specified precisely, the conditions used were an ambient temperature of +23 °C +73.4 °F.
- 2) The value is in standard condition [+23 °C +73.4 °F / 50 % RH, no bending fiber (R50 mm R1.969 in or more)].
- 3) The value is based on outer shape of fiber head.
- 4) It has a repeat flexibility as below.

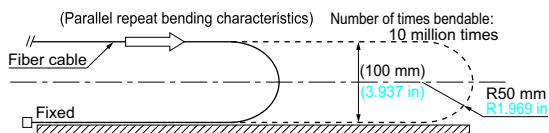

- 5) The ambient temperatures are the values for dry conditions. The ambient temperatures will vary for environments with high humidity. The ambient temperature for environments with high relative humidity of 85 % RH is -55 to +70 °C -67 to +158 °F. When the ambient humidity is +80 °C +176 °F, the ambient humidity is 35 to 50 % RH.

LIST OF FIBERS

Pliable fibers (flexible and sharp bending fibers) are marked in light blue in the table.

Thru-beam type (one pair set)



Type	Shape of fiber head (mm in)	Sensing range (mm in) (Note 1)		Beam axis dia. (mm in)	Fiber cable length ✂️: Free-cut	Bending radius	Ambient temperature	Model No.		
		■ : HYPR ■ : STD ■ : H-SP	U-LG LONG FAST							
Threaded type	Lens mountable (FX-LE1/LE2/SV1) 	3,600 (Note 2) 141.732	U-LG : 2,400 LONG : 2,100 FAST : 570	2,400 94.488 82.677 22.441	2 m 6.562 ft	R25 mm R0.984 in	-40 to +70 °C -40 to +158 °F	FT-B8		
	Metal-free 	180 7.087							FT-41	
	Lens mountable (FX-LE1/LE2/SV1) 	3,300 129.921	U-LG : 2,000 LONG : 1,550 FAST : 445	2,000 78.740 61.024 17.520						FT-FM2
	Sleeve 90 mm 3.543 in 	150 5.906						2 m 6.562 ft	Fiber R25 mm R0.984 in Sleeve R10 mm R0.394 in	FT-FM2S
	Sleeve 40 mm 1.575 in 									FT-FM2S4
	Lens mountable (FX-LE1/LE2/SV1) 	3,300 129.921	U-LG : 1,800 LONG : 1,400 FAST : 420	1,800 70.866 55.118 16.535					R1 mm R0.039 in	FT-W8
	Lens mountable (FX-LE1/LE2/SV1) 	3,300 129.921	U-LG : 2,000 LONG : 1,500 FAST : 470	2,000 78.740 59.055 18.504					R4 mm R0.157 in Flexible	FT-P80
	Lens mountable (FX-LE1/LE2/SV1) Tough flexible 	1,600 (Note 3) 62.992	U-LG : 1,600 LONG : 1,600 FAST : 530	1,600 62.992 20.866				1 m 3.281 ft	R10 mm R0.394 in	FT-P81X
	Lens mountable (FX-LE1/LE2/SV1) 	1,200 47.244	U-LG : 640 LONG : 560 FAST : 210	640 25.197 22.047 8.268					R4 mm R0.157 in Flexible	FT-P60
	Square head type		2,600 102.362	U-LG : 1,300 LONG : 1,100 FAST : 410				1,300 51.181 43.307 16.142	2 m 6.562 ft	R1 mm R0.039 in
With lens 		3,600 (Note 2) 141.732	U-LG : 3,600 LONG : 3,300 FAST : 1,300	3,600 141.732 129.921 51.181			FT-WR80L			
Elbow	Lens mountable (FX-LE1/LE2) 	3,500 137.795	U-LG : 1,750 LONG : 1,100 FAST : 450	1,750 68.898 43.307 17.717	2 m 6.562 ft	R25 mm R0.984 in	FT-R80			
M3	Lens mountable (FX-LE1/SV1) 	3,300 129.921	U-LG : 2,000 LONG : 1,550 FAST : 445	2,000 78.740 61.024 17.520	2 m 6.562 ft	R25 mm R0.984 in	FT-T80			
		1,220 48.031	U-LG : 740 LONG : 545 FAST : 192	740 29.134 21.457 7.559			FT-NFM2			

Notes: 1) Note that the sensing range of the free-cut type fiber may be reduced by 20 % max. depending upon how the fiber is cut.
 2) The fiber cable length practically limits the sensing range to 3,600 mm 141.732 in long.
 3) The fiber cable length practically limits the sensing range to 1,600 mm 62.992 in long.

LIST OF FIBERS

Pliable fibers (flexible and sharp bending fibers) are marked in light blue in the table.

Thru-beam type (one pair set)













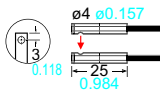

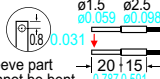
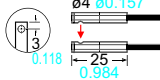
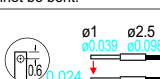

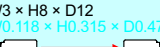



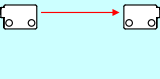

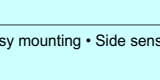

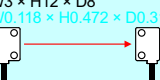

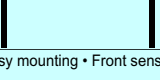
Type	Shape of fiber head (mm in)	Sensing range (mm in) (Note 1)		Beam axis dia. (mm in)	Fiber cable length (Free-cut)	Bending radius	Ambient temperature	Model No.		
		HYPR (red)	STD (purple)						H-SP (yellow)	U-LG LONG FAST
Threaded type	Sleeve 90 mm 3.543 in M3 ø0.88 ø0.035 10 0.394	1,220 48.031	310 12.205	63 2.480	U-LG : 740 LONG : 29.134 FAST : 545 21.457	ø0.5 ø0.020	2 m 6.562 ft	Fiber R25 mm R0.984 in Sleeve R10 mm R0.394 in	-40 to +70 °C -40 to +158 °F	FT-NFM2S
		960 37.795	250 9.843	53 2.087						U-LG : 590 LONG : 23.228 FAST : 150 5.906
	Sleeve 40 mm 1.575 in M3 ø0.88 ø0.035 10 0.394	1,220 48.031	310 12.205	63 2.480	U-LG : 740 LONG : 29.134 FAST : 545 21.457	ø0.5 ø0.020	2 m 6.562 ft	Fiber R25 mm R0.984 in Sleeve R10 mm R0.394 in	-40 to +70 °C -40 to +158 °F	FT-NFM2S
		960 37.795	250 9.843	53 2.087						U-LG : 590 LONG : 23.228 FAST : 150 5.906
	With lens M14 ø0.906	19,600 (Note 2) 771.652	19,600 (Note 2) 771.652	4,000 157.480	U-LG : 19,600 LONG : 19,600 FAST : 13,000 511.810	ø10 ø0.394	10 m 32.808 ft	R25 mm R0.984 in	-40 to +60 °C -40 to +158 °F	FT-FM10L
3,600 (Note 3) 141.732		3,300 129.921	640 25.197	U-LG : 3,600 LONG : 3,500 FAST : 1,700 66.929						FT-WS8L
Cylindrical type	With lens • Long sensing range ø3 ø0.118 8 0.315	3,600 (Note 3) 141.732	3,300 129.921	640 25.197	U-LG : 3,600 LONG : 3,500 FAST : 1,700 66.929	ø2 ø0.079	2 m 6.562 ft	R1 mm R0.039 in	-40 to +60 °C -40 to +140 °F	FT-WS8L
		3,300 129.921	790 31.102	150 5.906						U-LG : 1,900 LONG : 1,400 FAST : 460 18.110
	With lens • Long sensing range ø2.5 ø0.098 8 0.315	3,600 (Note 3) 141.732	2,600 102.362	440 17.323	U-LG : 3,600 LONG : 3,500 FAST : 1,400 55.118	ø2 ø0.079	2 m 6.562 ft	R25 mm R0.984 in	-40 to +70 °C -40 to +158 °F	FT-SFM2L
		3,300 129.921	1,100 43.307	150 5.906						U-LG : 2,000 LONG : 1,550 FAST : 445 17.520
	ø2.5 ø0.098 8 0.315	3,300 129.921	790 31.102	140 5.512	U-LG : 1,800 LONG : 1,400 FAST : 420 16.535	ø1 ø0.039	2 m 6.562 ft	R1 mm R0.039 in	-40 to +60 °C -40 to +140 °F	FT-WS8
		1,220 48.031	310 12.205	63 2.480						U-LG : 740 LONG : 29.134 FAST : 545 21.457
	ø1.5 ø0.059 8 0.315	1,220 48.031	310 12.205	63 2.480	U-LG : 740 LONG : 29.134 FAST : 545 21.457	ø0.5 ø0.020	2 m 6.562 ft	R25 mm R0.984 in	-40 to +70 °C -40 to +158 °F	FT-NFM2S
		960 37.795	250 9.843	53 2.087						U-LG : 590 LONG : 23.228 FAST : 150 5.906
	ø1.5 ø0.059 10 0.394	1,200 47.244	330 12.992	70 2.756	U-LG : 770 LONG : 570 FAST : 200 7.874	ø0.6 ø0.024	1 m 3.281 ft	R4 mm R0.157 in	-40 to +70 °C -40 to +158 °F	FT-P2
		350 13.780	90 3.543	19 0.748						U-LG : 210 LONG : 8.268 FAST : 60 2.362
ø1 ø0.039 6 0.236	350 13.780	90 3.543	19 0.748	U-LG : 210 LONG : 8.268 FAST : 60 2.362	ø0.25 ø0.010	500 mm 19.685 in	R4 mm R0.157 in Flexible	-40 to +60 °C -40 to +140 °F	FT-PS1	

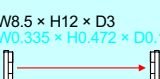
Notes: 1) Note that the sensing range of the free-cut type fiber may be reduced by 20 % max. depending upon how the fiber is cut.
 2) The fiber cable length practically limits the sensing range to 19,600 mm 771.652 in long.
 3) The fiber cable length practically limits the sensing range to 3,600 mm 141.732 in long.

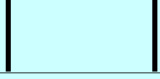
LIST OF FIBERS

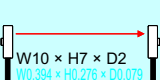
Pliable fibers (flexible and sharp bending fibers) are marked in light blue in the table.

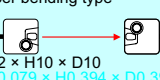
Thru-beam type (one pair set) 

Type	Shape of fiber head (mm in)	Sensing range (mm in) (Note 1)			Beam axis dia. (mm in)	Fiber cable length  : Free-cut	Bending radius	Ambient temperature	Model No.		
		■ : HYPR ■ : STD ■ : H-SP	U-LG LONG FAST								
Cylindrical type	Side-view		3,600 (Note 2) 141.732 3,500 137.795 850 33.465	U-LG : 3,600 LONG : 3,600 FAST : 2,400	141.732 141.732 141.732 94.488	ø2.5 ø0.098	 2 m 6.562 ft	R25 mm R0.984 in	-40 to +60 °C -40 to +140 °F	FT-V10	
			2,200 86.614 570 22.441 100 3.937	U-LG : 1,300 LONG : 1,000 FAST : 360	51.181 39.370 14.173	ø1.1 ø0.043				-20 to +70 °C -4 to +158 °F	FT-SFM2SV2
			1,200 47.244 300 11.811 90 3.543	U-LG : 600 LONG : 490 FAST : 200	23.622 19.291 7.874	ø0.8 ø0.031	1 m 3.281 ft			-20 to +60 °C -4 to +140 °F	FT-V22
			790 31.102 200 7.874 40 1.575	U-LG : 450 LONG : 360 FAST : 130	17.717 14.173 5.118	ø0.55 ø0.022	 2 m 6.562 ft			-40 to +60 °C -40 to +140 °F	FT-V41
			380 14.961 100 3.937 20 0.787	U-LG : 220 LONG : 170 FAST : 60	8.661 6.693 2.362	ø0.5 ø0.020		 R1 mm R0.039 in			FT-WV42
Rectangular	Compact	Easy mounting • Top sensing 	3,600 (Note 2) 141.732 3,300 129.921 630 24.803	U-LG : 3,600 LONG : 3,500 FAST : 1,800	141.732 141.732 141.732 70.866		 R1 mm R0.039 in		FT-WZ8H		
			3,600 (Note 2) 141.732 2,100 82.677 410 16.142	U-LG : 3,600 LONG : 3,300 FAST : 1,300	141.732 141.732 129.921 51.181		 R4 mm R0.157 in Flexible			FT-Z8H	
		Easy mounting • Side sensing 	3,600 (Note 2) 141.732 3,400 133.858 590 23.228	U-LG : 3,600 LONG : 3,600 FAST : 1,850	141.732 141.732 72.835	2.2 x 3 0.087 x 0.118	 2 m 6.562 ft	 R1 mm R0.039 in		FT-WZ8E	
			3,600 (Note 2) 141.732 2,000 78.740 490 19.291	U-LG : 3,600 LONG : 3,300 FAST : 1,300	141.732 141.732 129.921 51.181		 R4 mm R0.157 in Flexible			FT-Z8E	
		Easy mounting • Front sensing 	3,600 (Note 2) 141.732 1,300 51.181 280 11.024	U-LG : 3,100 LONG : 2,300 FAST : 830	122.047 90.551 32.677		 R1 mm R0.039 in			FT-WZ8	
			3,600 (Note 2) 141.732 1,200 47.244 250 9.843	U-LG : 2,700 LONG : 2,100 FAST : 750	106.299 82.677 29.528		 R4 mm R0.157 in Flexible			FT-Z8	
		Front sensing 	1,600 (Note 3) 62.992 530 20.866 100 3.937	U-LG : 1,100 LONG : 900 FAST : 330	43.307 35.433 12.992	ø1.5 ø0.059	 1 m 3.281 ft			FT-WZ4	
		Fiber bending type 	800 31.496 210 8.268 40 1.575	U-LG : 460 LONG : 370 FAST : 130	18.110 14.567 5.118	ø0.5 ø0.020		 R1 mm R0.039 in		FT-WZ4HB	
		Front sensing 	3,500 137.795 1,400 55.118 290 11.417	U-LG : 3,300 LONG : 2,300 FAST : 890	129.921 90.551 35.039	ø1.5 ø0.059	 2 m 6.562 ft			FT-WZ7	
		Fiber bending type 	3,500 137.795 790 31.102 160 6.299	U-LG : 1,700 LONG : 1,300 FAST : 490	66.929 51.181 19.291	ø1 ø0.039				FT-WZ7HB	

Notes: 1) Note that the sensing range of the free-cut type fiber may be reduced by 20 % max. depending upon how the fiber is cut.
 2) The fiber cable length practically limits the sensing range to 3,600 mm 141.732 in long.
 3) The fiber cable length practically limits the sensing range to 1,600 mm 62.992 in long.

LIST OF FIBERS

Pliable fibers (flexible and sharp bending fibers) are marked in light blue in the table.

Thru-beam type (one pair set)



Type	Shape of fiber head (mm in)	Sensing range (mm in) (Note 1)		Beam axis dia. (mm in)	Fiber cable length	Bending radius	Ambient temperature	Model No.								
		■ : HYPR ■ : STD ■ : H-SP	U-LG LONG FAST													
Special	Narrow beam 	3,600 (Note 2)	U-LG : 3,600 LONG : 3,600 FAST : 2,700	3,600 (Note 2)	141.732	141.732	141.732	106.299	2.2 0.087	Free-cut	R25 mm R0.984 in	-40 to +60 °C -40 to +140 °F	FT-K8			
		750	29.528	3,600 (Note 2)	141.732	3,600 (Note 2)	141.732	141.732	106.299	2.5 0.098	2 m 6.562 ft	R1 mm R0.039 in	-40 to +60 °C -40 to +140 °F	FT-WKV8		
		760	29.921	3,600 (Note 2)	141.732	3,600 (Note 2)	141.732	141.732	106.299	1 0.039	Free-cut	R10 mm R0.394 in	-40 to +60 °C -40 to +140 °F	FT-KV8		
	Wide beam	Wide area sensing 	2,400	94.488	540	21.260	160	6.299	U-LG : 1,100 LONG : 850 FAST : 430	1,100 43.307 33.465 16.929	3.2 x 32	0.126 1.260	2 m 6.562 ft	R1 mm R0.039 in	-40 to +55 °C -40 to +131 °F	FT-WA30
			3,600 (Note 2)	141.732	3,600 (Note 2)	141.732	3,600 (Note 2)	141.732	141.732	106.299	10 mm 0.394 in	Free-cut	R10 mm R0.394 in	-40 to +60 °C -40 to +140 °F	FT-A30	
			980	38.583	3,600 (Note 2)	141.732	3,600 (Note 2)	141.732	141.732	106.299	2.2 x 11	0.087 0.433	2 m 6.562 ft	R1 mm R0.039 in	-40 to +55 °C -40 to +131 °F	FT-WA8
	Array	Top sensing 	3,500	137.795	860	33.858	160	6.299	U-LG : 2,000 LONG : 1,500 FAST : 490	2,000 78.740 59.055 19.291	0.265 x 5.5 0.010 x 0.217	2 m 6.562 ft	R25 mm R0.984 in	-40 to +70 °C -40 to +158 °F	FT-AFM2	
			3,500	137.795	860	33.858	160	6.299	U-LG : 2,000 LONG : 1,500 FAST : 490	2,000 78.740 59.055 19.291	0.265 x 5.5 0.010 x 0.217	2 m 6.562 ft	R25 mm R0.984 in	-40 to +70 °C -40 to +158 °F	FT-AFM2E	
			3,500	137.795	860	33.858	160	6.299	U-LG : 2,000 LONG : 1,500 FAST : 490	2,000 78.740 59.055 19.291	0.265 x 5.5 0.010 x 0.217	2 m 6.562 ft	R25 mm R0.984 in	-40 to +70 °C -40 to +158 °F	FT-AFM2E	
	Heat-resistant	350 °C 662 °F Lens mountable (FX-LE1/LE2/SV1) 	1,200	47.244	430	16.929	80	3.150	U-LG : 880 LONG : 670 FAST : 250	880 34.646 26.378 9.843	0.12 0.047	2 m 6.562 ft	R25 mm R0.984 in	-60 to +350 °C -76 to +662 °F	FT-H35-M2	
			80	3.150	430	16.929	80	3.150	U-LG : 880 LONG : 670 FAST : 250	880 34.646 26.378 9.843	0.12 0.047	2 m 6.562 ft	Fiber R25 mm R0.984 in Sleeve R10 mm R0.394 in	-60 to +350 °C -76 to +662 °F	FT-H35-M2S6	
		200 °C 392 °F Lens mountable (FX-LE1/LE2/SV1) 	1,600 (Note 3)	62.992	470	18.504	90	3.543	U-LG : 1,000 LONG : 840 FAST : 300	1,000 39.370 33.071 11.811	0.8 0.031	1 m 3.281 ft	R10 mm R0.394 in	-60 to +200 °C	FT-H20W-M1	
1,600 (Note 3)			62.992	470	18.504	90	3.543	U-LG : 1,000 LONG : 840 FAST : 300	1,000 39.370 33.071 11.811	0.8 0.031	1 m 3.281 ft	R10 mm R0.394 in	-60 to +200 °C	FT-H20W-M1		
130 °C 266 °F Lens mountable (FX-LE2 only) 		1,600 (Note 3)	62.992	540	21.260	110	4.331	U-LG : 1,300 LONG : 960 FAST : 330	1,300 51.181 37.795 12.992	1.2 0.047	1 m 3.281 ft	R25 mm R0.984 in	-60 to +392 °F	FT-H20-M1		
		1,600 (Note 3)	62.992	540	21.260	110	4.331	U-LG : 1,300 LONG : 960 FAST : 330	1,300 51.181 37.795 12.992	1.2 0.047	1 m 3.281 ft	R25 mm R0.984 in	-60 to +392 °F	FT-H20-M1		
Heat-resistant	130 °C 266 °F Lens mountable (FX-LE2 only) 	3,300	129.921	700	27.559	140	5.512	U-LG : 1,900 LONG : 1,300 FAST : 410	1,900 74.803 51.181 16.142	1.5 0.059	2 m 6.562 ft	R25 mm R0.984 in	-60 to +130 °C -76 to +266 °F	FT-H13-FM2		
		3,300	129.921	700	27.559	140	5.512	U-LG : 1,900 LONG : 1,300 FAST : 410	1,900 74.803 51.181 16.142	1.5 0.059	2 m 6.562 ft	R25 mm R0.984 in	-60 to +130 °C -76 to +266 °F	FT-H13-FM2		

Notes: 1) Note that the sensing range of the free-cut type fiber may be reduced by 20 % max. depending upon how the fiber is cut.
 2) The fiber cable length practically limits the sensing range to 3,600 mm 141.732 in long.
 3) The fiber cable length practically limits the sensing range to 1,600 mm 62.992 in long.

LIST OF FIBERS

Pliable fibers (flexible and sharp bending fibers) are marked in light blue in the table.

Thru-beam type (one pair set)

Type	Shape of fiber head (mm in)	Sensing range (mm in) (Note 1)		Beam axis dia. (mm in)	Fiber cable length (Free-cut)	Bending radius	Ambient temperature	Model No.							
		■ : HYPR ■ : STD ■ : H-SP	U-LG LONG FAST												
Heat-resistant • Joint	Lens mountable (FX-LE1/LE2/SV1)				U-LG : 1,000 LONG : 790 FAST : 300	200 mm 7.874 in (Note 2) 300 mm 11.811 in (Note 2) 500 mm 19.685 in (Note 2) 500 mm 19.685 in (Note 2) 800 mm 31.496 in (Note 2)	Heat-resistant fiber R18 mm R0.709 in (Note 3)	-60 to +200 °C -76 to +392 °F	FT-H20-J20-S (Note 4)						
		U-LG : 1,300 LONG : 980 FAST : 390	FT-H20-J30-S (Note 4) FT-H20-J50-S (Note 4) FT-H20-VJ50-S (Note 4) FT-H20-VJ80-S (Note 4)												
	Side-view				U-LG : 3,600 (Note 5) LONG : 3,600 FAST : 1,900	2 m 6.562 ft			R25 mm R0.984 in	0 to +60 °C 32 to +140 °F	FT-Z802Y				
		Easy mounting • Rectangular head SEMI S2 compliant W7 × H15 × D13 W0.276 × H0.591 × D0.512									U-LG : 3,600 (Note 5) LONG : 3,600 FAST : 2,300	2 m 6.562 ft (Note 6)	R30 mm R1.181 in	-40 to +115 °C -40 to +239 °F	FT-HL80Y
			Chemical-resistant												U-LG : 3,600 (Note 5) LONG : 3,600 FAST : 2,800
Side-view					U-LG : 2,800 LONG : 2,200 FAST : 800	2 m 6.562 ft (Note 6)	R30 mm R1.181 in	-40 to +70 °C -40 to +158 °F	FT-V80Y						
	Vacuum-resistant				U-LG : 590 LONG : 470 FAST : 160				1 m 3.281 ft	R18 mm R0.709 in	-30 to +300 °C -22 to +572 °F	FT-H30-M1V-S (Note 7)			

- Notes: 1) Note that the sensing range of the free-cut type fiber may be reduced by 20 % max. depending upon how the fiber is cut.
 2) This is the fiber length (fixed length) for heat-resistant fibers. The ordinary-temperature fibers are free-cut to 2 m 6.562 ft.
 3) The bending radius for the ordinary-temperature fiber is R25 mm R0.984 in or more.
 4) Heat-resistant joint fibers and ordinary-temperature fibers (FT-FM2) are sold as a set.
 5) The fiber cable length practically limits the sensing range to 3,600 mm 141.732 in long.
 6) The allowable cutting range is 500 mm 19.685 in from the end that the amplifier inserted.
 7) Sold as a set comprising vacuum type fiber + photo-terminal (FV-BR1) + fiber at atmospheric side (FT-J8).

Heat-resistant joint fiber set contents

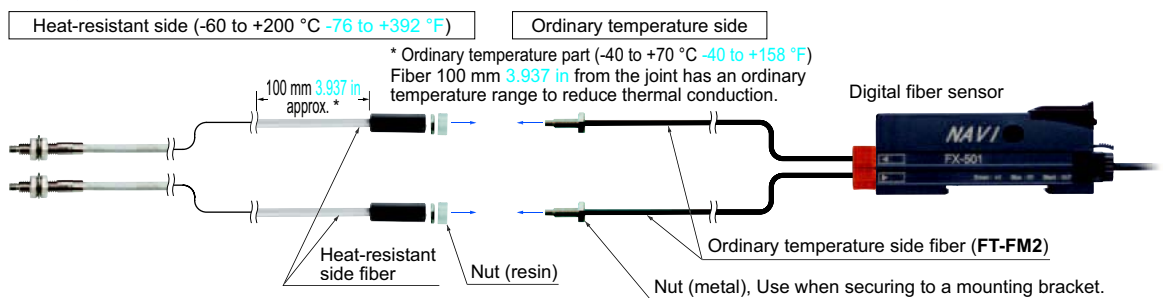

Model No. when ordering individual parts from spare parts

- Heat-resistant side fiber **one pair set**
 FT-H20-J20, FT-H20-J30, FT-H20-J50, FT-H20-VJ50, FT-H20-VJ80

LIST OF FIBERS

Pliable fibers (flexible and sharp bending fibers) are marked in light blue in the table.

Vacuum-resistant fiber set contents

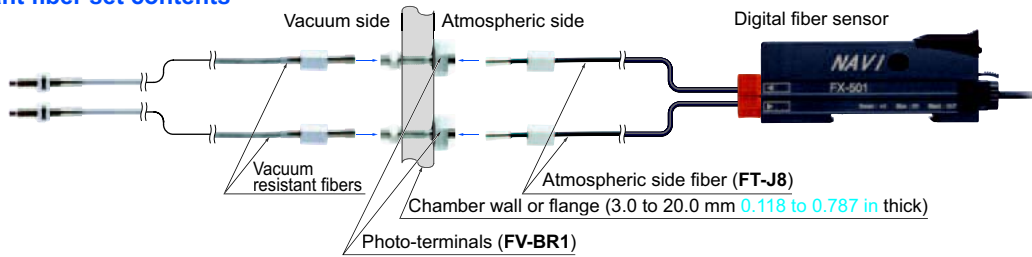

Model No. when ordering vacuum-resistant fibers individually as replacement parts

- Vacuum-resistant fiber **FT-H30-M1V** (one pair set)
- Photo-terminal **FV-BR1** (one pair set)
- Fiber at atmospheric side **FT-J8** (one pair set)

Retroreflective type

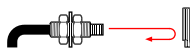

Type	Shape of fiber head (mm in)	Sensing range (mm in) (Note 1) (Note 2)		Fiber cable length 2 m 6.562 ft	Bending radius R1 mm R0.039 in	Ambient temperature -25 to +55 °C -13 to +131 °F	Model No.
		■ : HYPR ■ : STD ■ : H-SP	U-LG LONG FAST				
Sharp bending With polarizing filters	W9.5 × H5.2 × D15 W0.374 × H0.205 × D0.591 W30 × H30 × D0.5 W1.181 × H1.181 × D0.020	100 to 1,900 3.937 to 74.803 100 to 990 3.937 to 38.976 100 to 490 3.937 to 19.291	U-LG : 100 to 1,400 3.937 to 55.118 LONG : 100 to 1,200 3.937 to 47.244 FAST : 100 to 780 3.937 to 30.709	Free-cut	R1 mm R0.039 in	-25 to +55 °C -13 to +131 °F	FR-WKZ11
Narrow beam	Top sensing W9.5 × H5.2 × D21 W0.374 × H0.205 × D0.827 W10.6 × H28 × D10.1 W0.417 × H1.102 × D0.398	200 7.874 200 7.874	U-LG : 200 7.874 LONG : 200 7.874 FAST : 200 7.874	Free-cut	R10 mm R0.394 in	-40 to +60 °C -40 to +140 °F	FR-KZ21
	Side sensing W9.5 × H25 × D5.2 W0.374 × H0.984 × D0.205 W10.6 × H28 × D10.1 W0.417 × H1.102 × D0.398	200 7.874	FAST : 200 7.874	Free-cut	R10 mm R0.394 in	-40 to +60 °C -40 to +140 °F	FR-KZ21E
Wafer mapping	W7.5 × H22 × D11.2 W0.295 × H0.867 × D0.441 W4 × H2 × D21.5 W0.157 × H0.079 × D0.846	20 to 530 0.787 to 20.866 20 to 310 0.787 to 12.205 20 to 100 0.787 to 3.937	U-LG : 20 to 460 0.787 to 18.110 LONG : 20 to 410 0.787 to 16.142 FAST : 20 to 220 0.787 to 8.661	Free-cut	R10 mm R0.394 in	-40 to +60 °C -40 to +140 °F	FR-KV1

Notes: 1) Note that the sensing range of the free-cut type fiber may be reduced by 20 % max. depending upon how the fiber is cut. The sensing range of **FR-WKZ11** is specified for the **RF-13**. The sensing range of **FR-KZ21**, **FR-KZ21E** is specified for the attached reflector **RF-003**. The sensing range of **FR-KV1** is specified for the attached reflector. Refer to the table below for sensing range when **FR-WKZ11** is used in combination with a reflector (optional).

Reflector Amplifier	RF-230	RF-220	RF-210
FX-501(P)	100 to 3,600 3.937 to 141.732 (HYPR)	100 to 3,600 3.937 to 141.732 (HYPR)	100 to 2,500 3.937 to 98.425 (HYPR)
FX-502(P)	100 to 3,600 3.937 to 141.732 (U-LG)	100 to 3,000 3.937 to 118.110 (U-LG)	100 to 1,800 3.937 to 70.866 (U-LG)
	100 to 3,600 3.937 to 141.732 (LONG)	100 to 2,700 3.937 to 106.299 (LONG)	100 to 1,600 3.937 to 62.992 (LONG)
	100 to 3,500 3.937 to 137.795 (STD)	100 to 1,900 3.937 to 74.803 (STD)	100 to 1,200 3.937 to 47.244 (STD)
	100 to 2,900 3.937 to 114.173 (FAST)	100 to 1,500 3.937 to 59.055 (FAST)	100 to 960 3.937 to 37.795 (FAST)
	100 to 1,100 3.937 to 43.307 (H-SP)	100 to 900 3.937 to 35.433 (H-SP)	100 to 460 3.937 to 18.110 (H-SP)

- 2) The sensing range of **FR-WKZ11** is the possible setting range for the reflective tape. The fiber can detect an object less than 100 mm 3.937 in away. However, note that if there are any white or highly-reflective surfaces near the fiber head, reflected incident light may affect the fiber head. If this occurs, adjust the threshold value of the amplifier unit before use. The sensing range of **FR-KZ21** and **FR-KZ21E** is the possible setting range for the reflector. However, if setting the fiber to detect objects passing within 0 to 20 mm 0 to 0.787 in from the fiber head, unstable detection may result. The sensing range of **FR-KV1** is the possible setting range for the reflector. The fiber can detect an object less than 20 mm 0.787 in away.

LIST OF FIBERS

Pliable fibers (flexible and sharp bending fibers) are marked in light blue in the table.

Reflective type

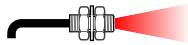

Type	Shape of fiber head (mm in)	Sensing range (mm in) (Note 1) (Note 2)		Fiber cable length ✂ : Free-cut	Bending radius	Ambient temperature	Model No.	
		■ : HYPR ■ : STD ■ : H-SP	U-LG LONG FAST					
Threaded type	M6		1,450 57.087	U-LG : 960 LONG : 860 FAST : 330	✂ 2 m 6.562 ft	R25 mm R0.984 in	-40 to +70 °C -40 to +158 °F	FD-B8
			1,000 39.370	U-LG : 680 LONG : 600 FAST : 200				FD-G60
			1,400 55.118	U-LG : 800 LONG : 650 FAST : 200				FD-FM2
			1,100 43.307	U-LG : 700 LONG : 540 FAST : 220				FD-FM2S
			380 14.961	FAST : 8.661				FD-FM2S4
		870 34.252	U-LG : 560 LONG : 420 FAST : 140	✂ 1 m 3.281 ft		R1 mm R0.039 in	-40 to +60 °C -40 to +140 °F	FD-W8
		820 32.283	U-LG : 610 LONG : 480 FAST : 160			R4 mm R0.157 in	Flexible	FD-P80
		450 17.717	U-LG : 370 LONG : 330 FAST : 160			R10 mm R0.394 in	-40 to +70 °C -40 to +158 °F	FD-P81X
		890 35.039	U-LG : 500 LONG : 370 FAST : 130	✂ 2 m 6.562 ft		R25 mm R0.984 in	-40 to +70 °C -40 to +158 °F	FD-R80
	M4		1,100 43.307	U-LG : 700 LONG : 540 FAST : 220		✂ 2 m 6.562 ft	R25 mm R0.984 in	-40 to +70 °C -40 to +158 °F
		380 14.961	FAST : 8.661	FD-NFM2				
		510 20.079	U-LG : 280 LONG : 215 FAST : 70	Fiber R25 mm R0.984 in Sleeve R10 mm R0.394 in	FD-NFM2S			
		120 4.724	FAST : 2.756	R10 mm R0.394 in	FD-NFM2S4			
		330 12.992	U-LG : 180 LONG : 140 FAST : 45	Fiber R1 mm R0.039 in Sleeve R10 mm R0.394 in	-40 to +60 °C -40 to +140 °F		FD-W44	
		870 34.252	U-LG : 560 LONG : 420 FAST : 140	R1 mm R0.039 in	FD-WT8			
		250 9.843	FAST : 5.512					

Notes: 1) The sensing range is specified for white non-glossy paper.
2) Note that the sensing range of the free-cut type fiber may be reduced by 20 % max. depending upon how the fiber is cut.

LIST OF FIBERS

Pliable fibers (flexible and sharp bending fibers) are marked in light blue in the table.

Reflective type

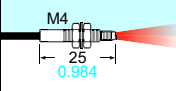
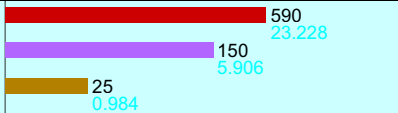
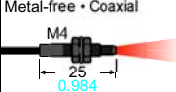
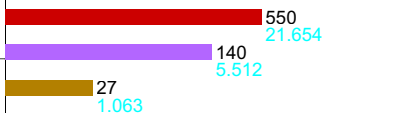
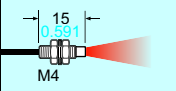
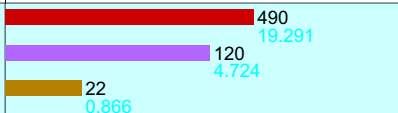
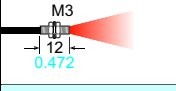
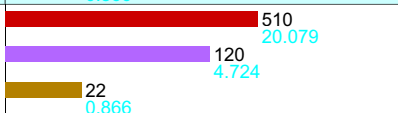
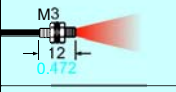
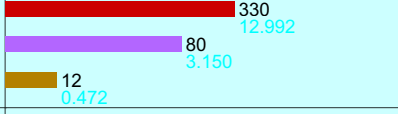
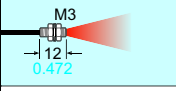
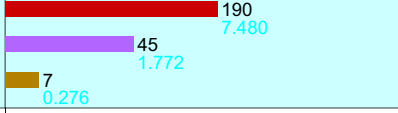
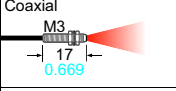
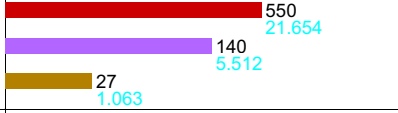
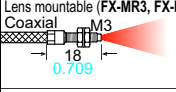
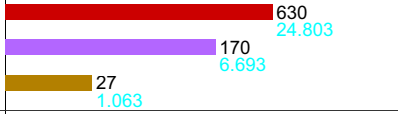
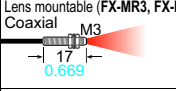
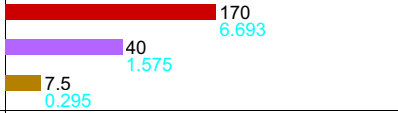
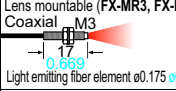
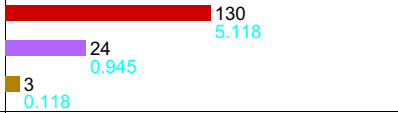
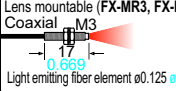
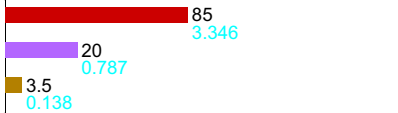
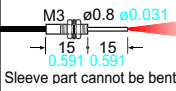
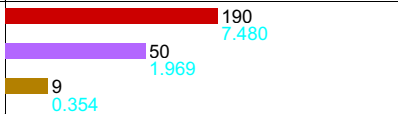
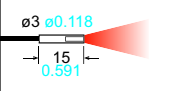
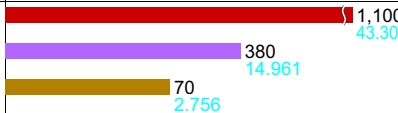
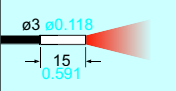
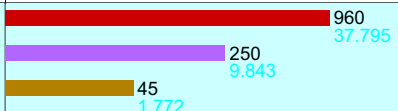

Type	Shape of fiber head (mm in)	Sensing range (mm in) (Note 1) (Note 2)		Fiber cable length ✂: Free-cut	Bending radius	Ambient temperature	Model No.		
		■ : HYPR ■ : STD ■ : H-SP	U-LG LONG FAST						
Threaded type	Minute objects can be detected due to the small spot beam. Coaxial • Lens mountable (FX-MR1/MR2/MR3/MR5/MR6) 		590 23.228 150 5.906 25 0.984	U-LG : 340 LONG : 280 FAST : 90 13.386 11.024 3.543	✂	R2 mm R0.079 in	-40 to +60 °C -40 to +140 °F	FD-WG4	
		Metal-free • Coaxial 		550 21.654 140 5.512 27 1.063	U-LG : 330 LONG : 270 FAST : 80 12.992 10.630 3.150	✂ 2 m 6.562 ft	R25 mm R0.984 in	-40 to +70 °C -40 to +158 °F	FD-G4 FD-G40
					490 19.291 120 4.724 22 0.866	U-LG : 250 LONG : 190 FAST : 75 9.843 7.480 2.953	✂	R4 mm R0.157 in Flexible	-40 to +60 °C -40 to +140 °F
	Small diameter 		510 20.079 120 4.724 22 0.866	U-LG : 280 LONG : 215 FAST : 70 11.024 8.465 2.756	✂	R25 mm R0.984 in	-40 to +70 °C -40 to +158 °F	FD-T40	
				330 12.992 80 3.150 12 0.472	U-LG : 180 LONG : 140 FAST : 45 7.087 5.512 1.772	✂ 2 m 6.562 ft	R1 mm R0.039 in	-40 to +60 °C -40 to +140 °F	FD-WT4
				190 7.480 45 1.772 7 0.276	U-LG : 100 LONG : 85 FAST : 20 3.937 3.346 0.787	✂	R4 mm R0.157 in Flexible	-40 to +70 °C -40 to +158 °F	FD-P40
		Lens mountable (FX-MR3, FX-MR6) Coaxial 		550 21.654 140 5.512 27 1.063	U-LG : 330 LONG : 270 FAST : 80 12.992 10.630 3.150	✂	R25 mm R0.984 in	-40 to +60 °C	FD-G6
		Tough flexible Lens mountable (FX-MR3, FX-MR6) Coaxial 		630 24.803 170 6.693 27 1.063	U-LG : 370 LONG : 310 FAST : 95 14.567 12.205 3.740	✂ 1 m 3.281 ft (Note 3)	R10 mm R0.394 in	-40 to +60 °C -40 to +140 °F	FD-G6X
		High precision Lens mountable (FX-MR3, FX-MR6) Coaxial 		170 6.693 40 1.575 7.5 0.295	U-LG : 100 LONG : 80 FAST : 24 3.937 3.150 0.945	✂	R25 mm R0.984 in	-40 to +60 °C	FD-EG1
		High precision Lens mountable (FX-MR3, FX-MR6) Coaxial 		130 5.118 24 0.945 3 0.118	U-LG : 100 LONG : 80 FAST : 19 3.937 3.150 0.748	✂	R10 mm R0.394 in	-20 to +60 °C -4 to +140 °F	FD-EG2
High precision Lens mountable (FX-MR3, FX-MR6) Coaxial 			85 3.346 20 0.787 3.5 0.138	U-LG : 45 LONG : 35 FAST : 12 1.772 1.378 0.472	✂	R10 mm R0.394 in	-20 to +60 °C -4 to +140 °F	FD-EG3	
Coaxial 		190 7.480 50 1.969 9 0.354	U-LG : 110 LONG : 90 FAST : 28 4.331 3.543 1.102	✂ 1 m 3.281 ft	R25 mm R0.984 in	-40 to +60 °C	FD-ENM1S1		
Cylindrical type			1,100 43.307 380 14.961 70 2.756	U-LG : 700 LONG : 540 FAST : 220 27.559 21.260 8.661	✂ 2 m 6.562 ft	R25 mm R0.984 in	-40 to +70 °C -40 to +158 °F	FD-S80	
			960 37.795 250 9.843 45 1.772	U-LG : 550 LONG : 410 FAST : 140 21.654 16.142 5.512	✂	R1 mm R0.039 in	-40 to +60 °C -40 to +140 °F	FD-WS8	

Notes: 1) The sensing range is specified for white non-glossy paper.
 2) Note that the sensing range of the free-cut type fiber may be reduced by 20 % max. depending upon how the fiber is cut.
 3) The allowable cutting range is 700 mm 27.559 in from the end that the amplifier inserted.

LIST OF FIBERS

Pliable fibers (flexible and sharp bending fibers) are marked in light blue in the table.

Reflective type

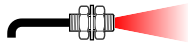

Type	Shape of fiber head (mm in)	Sensing range (mm in) (Note 1) (Note 2)		Fiber cable length ✂: Free-cut	Bending radius	Ambient temperature	Model No.
		■ : HYPR ■ : STD ■ : H-SP	U-LG LONG FAST				
Cylindrical type	Coaxial $\phi 3 \phi 0.118$ 	■ : 590 ■ : 23.228 ■ : 150 ■ : 5.906 ■ : 25 ■ : 0.984	U-LG : 340 LONG : 13.386 FAST : 280 FAST : 11.024 FAST : 90 FAST : 3.543	 2 m 6.562 ft	R2 mm R0.079 in	-40 to +60 °C -40 to +140 °F	FD-WSG4
		■ : 490 ■ : 19.291 ■ : 120 ■ : 4.724 ■ : 22 ■ : 0.866	U-LG : 250 LONG : 9.843 FAST : 190 FAST : 7.480 FAST : 75 FAST : 2.953				
	Coaxial $\phi 2.5 \phi 0.098$ 	■ : 510 ■ : 20.079 ■ : 120 ■ : 4.724 ■ : 22 ■ : 0.866	U-LG : 280 LONG : 11.024 FAST : 215 FAST : 8.465 FAST : 70 FAST : 2.756	 2 m 6.562 ft	R25 mm R0.984 in	-40 to +70 °C -40 to +158 °F	FD-SNFM2
	Coaxial $\phi 1.5 \phi 0.059$ 	■ : 260 ■ : 10.236 ■ : 80 ■ : 3.150 ■ : 20 ■ : 0.787	U-LG : 170 LONG : 6.693 FAST : 140 FAST : 5.512 FAST : 55 FAST : 2.165				
	Ultra-small diameter $\phi 1.5 \phi 0.5$ $\phi 0.059 \phi 0.020$ Sleeve part cannot be bent.	■ : 45 ■ : 1.772 ■ : 12 ■ : 0.472 ■ : 2 ■ : 0.079	U-LG : 25 LONG : 0.984 FAST : 22 FAST : 0.866 FAST : 7 FAST : 0.276	1 m 3.281 ft	R10 mm R0.394 in	-40 to +60 °C -40 to +140 °F	FD-E12
	Ultra-small diameter $\phi 3 \phi 0.65$ $\phi 0.118 \phi 0.026$ Sleeve part cannot be bent.	■ : 210 ■ : 8.268 ■ : 55 ■ : 2.165 ■ : 11 ■ : 0.433	U-LG : 130 LONG : 5.118 FAST : 110 FAST : 4.331 FAST : 32 FAST : 1.260				
	Side-view Small diameter Sleeve part cannot be bent.	■ : 260 ■ : 10.236 ■ : 65 ■ : 2.559 ■ : 14 ■ : 0.551	U-LG : 140 LONG : 5.512 FAST : 110 FAST : 4.331 FAST : 35 FAST : 1.378	R25 mm R0.984 in	-40 to +60 °C -40 to +140 °F	FD-V41	
	Side-view Sleeve part cannot be bent.	■ : 60 ■ : 2.362 ■ : 16 ■ : 0.630 ■ : 2 ■ : 0.079	U-LG : 35 LONG : 1.378 FAST : 25 FAST : 0.984 FAST : 8 FAST : 0.315				 2 m 6.562 ft
	Side-view Sleeve part cannot be bent.	■ : 370 ■ : 14.567 ■ : 120 ■ : 4.724 ■ : 25 ■ : 0.984	U-LG : 250 LONG : 9.843 FAST : 210 FAST : 8.268 FAST : 75 FAST : 2.953	R25 mm R0.984 in	-20 to +60 °C -4 to +140 °F	FD-SFM2SV2	
	Rectangular	Glass substrate detection • Mapping W25 × H7.3 × D30 W0.984 × H0.287 × D1.181	■ : 1 to 110 ■ : 0.039 to 4.331				U-LG : 1 to 87 LONG : 0.039 to 3.425 FAST : 1 to 74 FAST : 0.039 to 2.913 FAST : 1 to 38 FAST : 0.039 to 1.496
Cannot use ■ : 1 to 56 ■ : 0.039 to 2.205			U-LG : 43 LONG : 1.693 FAST : 43 FAST : 1.693 FAST : 40 FAST : 1.575	 3 m 9.843 ft	R4 mm R0.157 in	FD-L45	
Glass substrate detection • Alignment W20 × H29 × D3.8 W0.787 × H1.142 × D0.150		■ : 3 to 51 ■ : 0.118 to 2.008 ■ : 4 to 44 ■ : 0.157 to 1.732 ■ : 5 to 38 ■ : 0.197 to 1.496	U-LG : 4 to 47 LONG : 0.157 to 1.850 FAST : 4 to 46 FAST : 0.157 to 1.811 FAST : 4 to 42 FAST : 0.157 to 1.654				R25 mm R0.984 in
Glass substrate detection • Alignment W17 × H29 × D3.8 W0.669 × H1.142 × D0.150		■ : 31 ■ : 1.220 ■ : 24 ■ : 0.945 ■ : 18 ■ : 0.709	U-LG : 25 LONG : 0.984 FAST : 24 FAST : 0.945 FAST : 24 FAST : 0.945	 2 m 6.562 ft	R4 mm R0.157 in	FD-L43	
Glass substrate detection • Seating confirmation W18 × H29 × D3.8 W0.709 × H1.142 × D0.150		■ : 30 ■ : 1.181 ■ : 29 ■ : 1.142 ■ : 1.5 to 24 ■ : 0.059 to 0.945	U-LG : 30 LONG : 1.181 FAST : 30 FAST : 1.181 FAST : 28 FAST : 1.102				 3 m 9.843 ft

Notes: 1) The sensing range is specified for white non-glossy paper (FD-L46: 100 × 100 × t 0.7 mm 3.937 × 3.937 × t 0.028 in R edge of LCD glass substrates, FD-L45, FD-L45A, FD-L43 and FD-L47: 100 × 100 × t 0.7 mm 3.937 × 3.937 × t 0.028 in transparent glass) as the object.
 2) Note that the sensing range of the free-cut type fiber may be reduced by 20 % max. depending upon how the fiber is cut.

LIST OF FIBERS

Pliable fibers (flexible and sharp bending fibers) are marked in light blue in the table.

Reflective type



Type	Shape of fiber head (mm in)	Sensing range (mm in) (Note 1) (Note 2)		Fiber cable length ✂: Free-cut	Bending radius	Ambient temperature	Model No.	
		■ : HYPR ■ : STD ■ : H-SP	U-LG LONG FAST					
Rectangular	Glass substrate detection • Seating confirmation W12 × H19 × D3 W0.472 × H0.748 × D0.118	■ 11.5 ■ 0.453 ■ 9.5 ■ 0.374 ■ 8 ■ 0.315	U-LG : 10.5 0.413 LONG : 10 0.394 FAST : 9 0.354	✂	R10 mm R0.394 in	-40 to +60 °C -40 to +140 °F	FD-L44	
		■ 6 ■ 0.236 ■ 5 ■ 0.197 ■ 4 ■ 0.157	U-LG : 5.5 0.217 LONG : 5.5 0.217 FAST : 4.5 0.177				FD-L44S	
	Convergent reflective type W24 × H21 × D4 W0.945 × H0.827 × D0.157	■ 1.5 to 15 ■ 0.059 to 0.591 ■ 2.5 to 14 ■ 0.098 to 0.551 ■ 6.5 to 10 ■ 0.256 to 0.394	U-LG : 2 to 14.5 0.079 to 0.571 LONG : 2 to 14.5 0.079 to 0.571 FAST : 5.5 to 13.5 0.217 to 0.531	✂	R1 mm R0.039 in			FD-WL41
		■ 1 to 19 ■ 0.039 to 0.748 ■ 1.5 to 16 ■ 0.059 to 0.630 ■ 8 to 11 ■ 0.315 to 0.433	U-LG : 1 to 18 0.039 to 0.709 LONG : 1.5 to 16 0.059 to 0.630 FAST : 3 to 15 0.118 to 0.591	✂	R10 mm R0.394 in			FD-L41
		■ 21.5 ■ 0.846 ■ 15.5 ■ 0.610 ■ 5 to 7.5 ■ 0.197 to 0.295	U-LG : 19.5 0.768 LONG : 18.5 0.728 FAST : 3 to 13 0.118 to 0.512	✂	R10 mm R0.394 in		-40 to +70 °C -40 to +158 °F	FD-L4
		■ 16 ■ 0.630 ■ 7.5 ■ 0.295 ■ 0.5 to 4 ■ 0.020 to 0.157	U-LG : 12.5 0.492 LONG : 11.5 0.453 FAST : 0.5 to 6 0.020 to 0.236	✂	R1 mm R0.039 in		-20 to +60 °C -4 to +140 °F	FD-WL48
	Small	Front sensing W10 × H7 × D2 W0.394 × H0.276 × D0.079	■ 1 to 230 ■ 0.039 to 9.055 ■ 2 to 65 ■ 0.079 to 2.559 ■ 5 to 13 ■ 0.197 to 0.512	U-LG : 1 to 110 0.039 to 4.331 LONG : 1 to 85 0.039 to 3.346 FAST : 3 to 35 0.118 to 1.378	✂			FD-WZ4
		Fiber bending type W2 × H10 × D10 W0.079 × H0.394 × D0.394	■ 1 to 190 ■ 0.039 to 7.480 ■ 2.5 to 65 ■ 0.098 to 2.559 ■ 3 to 11 ■ 0.118 to 0.433	U-LG : 1 to 130 0.039 to 5.118 LONG : 1 to 90 0.039 to 3.543 FAST : 2.5 to 40 0.098 to 1.575	✂	R1 mm R0.039 in	-40 to +60 °C -40 to +140 °F	FD-WZ4HB
		Front sensing W14 × H7 × D3.5 W0.551 × H0.276 × D0.138	■ 430 ■ 16.929 ■ 110 ■ 4.331 ■ 3 to 25 ■ 0.118 to 0.984	U-LG : 230 9.055 LONG : 180 7.087 FAST : 1.5 to 65 0.059 to 2.559	✂			FD-WZ7
		Fiber bending type W3.5 × H14 × D11 W0.138 × H0.551 × D0.433	■ 0.5 to 560 ■ 0.020 to 22.047 ■ 1 to 150 ■ 0.039 to 5.906 ■ 2.5 to 30 ■ 0.098 to 1.181	U-LG : 0.5 to 320 0.020 to 12.598 LONG : 0.5 to 270 0.020 to 10.630 FAST : 1 to 90 0.039 to 3.543	✂			FD-WZ7HB
Special	Long sensing range • Rectangular head W52 × H9.5 × D15 W0.205 × H0.374 × D0.591	■ 20 to 1,700 ■ 0.787 to 66.929 ■ 20 to 490 ■ 0.787 to 19.291 ■ 20 to 100 ■ 0.787 to 3.937	U-LG : 20 to 1,000 0.787 to 39.370 LONG : 20 to 820 0.787 to 32.283 FAST : 20 to 310 0.787 to 12.205	✂	R1 mm R0.039 in	-40 to +60 °C -40 to +140 °F	FD-WKZ1	
	Wide beam W7 × H15 × D30 W0.276 × H0.591 × D1.181	■ 200 ■ 7.874 ■ 200 ■ 7.874 ■ 75 ■ 2.953	U-LG : 200 7.874 LONG : 200 7.874 FAST : 140 5.512	✂	R25 mm R0.984 in		FD-A15	
	Array Top sensing W5 × H20 × D20 W0.197 × H0.787 × D0.787	■ 660 ■ 25.984 ■ 280 ■ 11.024	U-LG : 510 20.079 LONG : 430 16.929 FAST : 160 6.299	✂	R25 mm R0.984 in	-40 to +70 °C -40 to +158 °F	FD-AFM2	
Side sensing W5 × H20 × D20 W0.197 × H0.787 × D0.787	■ 50 ■ 1.969		✂			FD-AFM2E		

Notes: 1) The sensing range is specified for white non-glossy paper (FD-L44, FD-WL41 and FD-L41: 100 × 100 × t 0.7 mm 3.937 × 3.937 × t 0.028 in transparent glass, FD-L44S: silicon wafers polished surface) as the object.
 2) Note that the sensing range of the free-cut type fiber may be reduced by 20 % max. depending upon how the fiber is cut.

LIST OF FIBERS

Pliable fibers (flexible and sharp bending fibers) are marked in light blue in the table.

Reflective type



Type	Shape of fiber head (mm in)	Sensing range (mm in) (Note 1) (Note 2)		Fiber cable length ✂ : Free-cut	Bending radius	Ambient temperature	Model No.		
		■ : HYPR ■ : STD ■ : H-SP	U-LG LONG FAST						
Special	Liquid level sensing	Heat resistant 125 °C 257 °F Fluorine resin coating ø6 0.236	ø6 mm 0.236 in Protective tube: Fluorine resin, length 1,000 mm 39.370 in (not cuttable) Liquid surface contacted: Beam received, Liquid surface not contacted: Beam interrupted	720 28.346	U-LG : 540 LONG : 21.260 FAST : 150 5.906	2 m 6.562 ft (Note 3)	Protective tube R40 mm R1.575 in Fiber R15 mm R0.591 in	-40 to +125 °C -40 to +257 °F	FD-F8Y
		Heat resistant 105 °C 221 °F Fluorine resin coating ø4 0.157	ø4 mm 0.157 in Protective tube: Fluorine resin, length 500 mm 19.685 in (cuttable) Liquid surface contacted: Beam received, Liquid surface not contacted: Beam interrupted	260 10.236	U-LG : 540 LONG : 21.260 FAST : 150 5.906	2 m 6.562 ft	Protective tube R20 mm R0.787 in Fiber R10 mm R0.394 in	-40 to +105 °C -40 to +221 °F	FD-HF40Y
		Heat resistant 70 °C 158 °F Fluorine resin coating throughout the fiber ø4 0.157	ø4 mm 0.157 in Protective tube: Fluorine resin, length 500 mm 19.685 in (cuttable) Liquid surface contacted: Beam received, Liquid surface not contacted: Beam interrupted	45 1.772	U-LG : 540 LONG : 21.260 FAST : 150 5.906	2 m 6.562 ft	Protective tube R20 mm R0.787 in Fiber R4 mm R0.157 in	-40 to +70 °C -40 to +158 °F	FD-F41Y
		Mountable on pipe • Standard W25 × H13 × D20 W0.984 × H0.512 × D0.787	Applicable pipe diameter: Outer dia. ø6 to ø26 mm 0.236 to ø1.024 in transparent pipe [PVC (vinyl chloride), fluorine resin, polycarbonate, acrylic, glass, wall thickness 1 to 3 mm 0.039 to 0.118 in] Liquid absent: Beam received, Liquid present: Beam interrupted	840 33.071	U-LG : 540 LONG : 21.260 FAST : 150 5.906	2 m 6.562 ft	Protective tube R20 mm R0.787 in Fiber R4 mm R0.157 in	-40 to +100 °C -40 to +212 °F	FD-F41
		Mountable on pipe • For PFA, wall thickness 1 mm 0.039 in pipe W25 × H13 × D20 W0.984 × H0.512 × D0.787	Applicable pipe diameter: Outer dia. ø6 to ø26 mm 0.236 to ø1.024 in transparent pipe [PFA (fluorine resin) or equivalently transparent pipe, wall thickness 1 mm 0.039 in] Liquid absent: Beam received, Liquid present: Beam interrupted	840 33.071	U-LG : 540 LONG : 21.260 FAST : 150 5.906	2 m 6.562 ft	Protective tube R20 mm R0.787 in Fiber R4 mm R0.157 in	-40 to +100 °C -40 to +212 °F	FD-F4
Special	Liquid sensing	Mountable on pipe • Array fiber W6.5 × H28.3 × D17 W0.256 × H1.114 × D0.669	Applicable pipe diameter: Outer dia. ø8 mm 0.315 in or more transparent pipe (When used with the tying bands: ø8 to ø80 mm 0.315 to ø3.150 in) [PFA (fluorine resin), including translucent] Liquid absent: Beam received, Liquid present: Beam interrupted	720 28.346	U-LG : 540 LONG : 21.260 FAST : 150 5.906	2 m 6.562 ft	Protective tube R20 mm R0.787 in Fiber R4 mm R0.157 in	-40 to +70 °C -40 to +158 °F	FD-FA90
		Mountable on pipe SEMI S2 compliant W23 × H20 × D17 W0.906 × H0.787 × D0.669	Applicable pipe diameter: Outer dia. ø3 to ø10 mm 0.118 to ø0.394 in transparent pipe [PFA (fluorine resin) or equivalently transparent pipe, wall thickness 0.3 to 1 mm 0.012 to 0.039 in] Liquid absent: Beam received, Liquid present: Beam interrupted	840 33.071	U-LG : 540 LONG : 21.260 FAST : 150 5.906	2 m 6.562 ft	Protective tube R20 mm R0.787 in Fiber R4 mm R0.157 in	-20 to +60 °C -4 to +140 °F	FT-F902
Special	Liquid leak detection	SEMI S2 compliant W20 × H30 × D10 W0.787 × H1.181 × D0.394	Liquid leak detection Leak absent: Beam received, Leak present: Beam interrupted	720 28.346	U-LG : 540 LONG : 21.260 FAST : 150 5.906	5 m 16.404 ft (Protective tube: 3 m 9.843 ft)	Protective tube R20 mm R0.787 in Fiber R4 mm R0.157 in	-20 to +50 °C -4 to +122 °F	FD-F705
		Heat-resistant	350 °C 662 °F • Coaxial M6 25 0.984	720 28.346	U-LG : 540 LONG : 21.260 FAST : 150 5.906	2 m 6.562 ft	R25 mm R0.984 in	-60 to +350 °C -76 to +662 °F	FD-H35-M2
Special	Heat-resistant	350 °C 662 °F • Sleeve 60 mm 2.362 in M6 ø2.8 0.110 22 0.866	45 1.772	U-LG : 540 LONG : 21.260 FAST : 150 5.906	2 m 6.562 ft	Fiber R25 mm R0.984 in Sleeve R10 mm R0.394 in	-60 to +350 °C -76 to +662 °F	FD-H35-M2S6	
		200 °C 392 °F • Coaxial M6 28 1.102	840 33.071	U-LG : 540 LONG : 21.260 FAST : 150 5.906	2 m 6.562 ft	R25 mm R0.984 in	-60 to +200 °C -76 to +392 °F	FD-H20-M1	
		350 °C 662 °F • Sleeve 90 mm 3.543 in M4 ø2.1 0.083 27 1.063	840 33.071	U-LG : 540 LONG : 21.260 FAST : 150 5.906	1 m 3.281 ft	Fiber R25 mm R0.984 in Sleeve R10 mm R0.394 in	-60 to +350 °C -76 to +662 °F	FD-H35-20S	
		200 °C 392 °F • Coaxial M4 27 1.063	770 30.315	U-LG : 540 LONG : 21.260 FAST : 150 5.906	1 m 3.281 ft	R25 mm R0.984 in	-60 to +200 °C -76 to +392 °F	FD-H20-21	
		300 °C 572 °F • Glass substrate detection Convergent reflective type W19 × H27 × D5 W0.748 × H1.063 × D0.197	40 1.575	U-LG : 30 LONG : 1.181 FAST : 12 0.472	2 m 6.562 ft	R25 mm R0.984 in	-60 to +300 °C -76 to +572 °F	FD-H30-L32	

Notes: 1) The sensing range is specified for white non-glossy paper (FD-H30-L32: 100 × 100 × t 0.7 mm 3.937 × 3.937 × t 0.028 in transparent glass) as the object.

2) Note that the sensing range of the free-cut type fiber may be reduced by 20 % max. depending upon how the fiber is cut.

3) The allowable cutting range is 1,000 mm 39.370 in from the end that the amplifier inserted.

LIST OF FIBERS

Pliable fibers (flexible and sharp bending fibers) are marked in light blue in the table.

Reflective type



Type	Shape of fiber head (mm in)	Sensing range (mm in) (Note 1) (Note 2)		Fiber cable length ✂️: Free-cut	Bending radius	Ambient temperature	Model No.		
		■ : HYPR ■ : STD ■ : H-SP	U-LG LONG FAST						
Special	250 °C 482 °F • Glass substrate detection Convergent reflective type W21 × H33.2 × D5 W0.827 × H1.307 × D0.197	■ 1 to 31 ■ 0.039 to 1.220 ■ 1.5 to 26 ■ 0.059 to 1.024 ■ 2 to 18 ■ 0.079 to 0.709	U-LG : 1 to 30 0.039 to 1.181 LONG : 1 to 28 0.039 to 1.102 FAST : 1.5 to 24 0.059 to 0.945	3 m 9.843 ft	R25 mm R0.984 in	-20 to +250 °C -4 to +482 °F	FD-H25-L43		
		■ 4 to 43.5 ■ 0.157 to 1.713 ■ 5 to 42 ■ 0.197 to 1.654 ■ 6.5 to 34 ■ 0.256 to 1.339	U-LG : 4 to 43 0.157 to 1.693 LONG : 4.5 to 43 0.177 to 1.693 FAST : 5 to 40 0.197 to 1.575				FD-H25-L45		
	180 °C 356 °F • Glass substrate detection Convergent reflective type W19 × H27 × D5 W0.748 × H1.063 × D0.197	■ 60 ■ 2.362 ■ 16 ■ 0.630 ■ 2 to 6.5 ■ 0.079 to 0.256	U-LG : 32 1.260 LONG : 24 0.945 FAST : 13 0.512	2 m 6.562 ft		-60 to +180 °C -76 to +356 °F	FD-H18-L31		
		■ 880 ■ 34.646 ■ 350 ■ 13.780 ■ 65 ■ 2.559	U-LG : 640 25.197 LONG : 600 23.622 FAST : 200 7.874			-60 to +130 °C -76 to +266 °F	FD-H13-FM2		
	Vacuum-resistant	300 °C 572 °F • Rectangular head W9.5 × H5.2 × D15 W0.374 × H0.205 × D0.591	■ 1 to 500 ■ 0.039 to 19.685 ■ 2 to 200 ■ 0.079 to 7.874 ■ 10 to 25 ■ 0.394 to 0.984	U-LG : 1 to 340 0.039 to 13.386 LONG : 1 to 270 0.039 to 10.630 FAST : 3 to 120 0.118 to 4.724		1 m 3.281 ft	R18 mm R0.709 in	-30 to +300 °C -22 to +572 °F	FD-H30-KZ1V-S (Note 3)
			300 °C 572 °F • Glass substrate detection Convergent reflective type W19 × H5 × D27 W0.748 × H0.197 × D1.063	■ 18 ■ 0.709 ■ 8 ■ 0.315 ■ 1.5 to 3 ■ 0.059 to 0.118					U-LG : 12 0.472 LONG : 10 0.394 FAST : 5.5 0.217

- Notes: 1) The sensing range is specified for white non-glossy paper (FD-H25-L43, FD-H25-L45, FD-H18-L31, FD-H30-KZ1V-S, FD-H30-L32V-S: 100 × 100 × t 0.7 mm 3.937 × 3.937 × t 0.028 in transparent glass) as the object.
 2) Note that the sensing range of the free-cut type fiber may be reduced by 20 % max. depending upon how the fiber is cut.
 3) Sold as a set comprising vacuum type fiber + photo-terminal (FV-BR1) + fiber at atmospheric side (FT-J8). Refer to P.6 for vacuum-resistant fiber set contents.

Model No. when ordering vacuum-resistant fibers individually as replacement parts

- Vacuum-resistant fiber
FD-H30-KZ1V
FD-H30-L32V
- Mounting bracket for FD-H30-KZ1V
MS-FD-2
- Photo-terminal
FV-BR1 (one pair set)
- Fiber at atmospheric side
FT-J8 (one pair set)

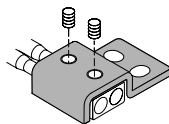

Accessories (attached with fibers)

- RF-003 (FR-KZ21/KZ21E exclusive reflector)
- RF-13 (Reflective tape)
- FX-CT1 (Fiber cutter)
- FX-CT2 (Fiber cutter)
- FX-CT3 (Fiber cutter)
- FX-AT2 (Attachment for fixed-length fiber, Orange)
- FX-AT3 (Attachment for ø2.2 mm ø0.087 in fiber, Clear orange)
- FX-AT4 (Attachment for ø1 mm ø0.039 in fiber, Black)
- FX-AT5 (Attachment for ø1.3 mm ø0.051 in fiber, Gray)
- FX-AT6 (Attachment for ø1 mm ø0.039 in / ø1.3 mm ø0.051 in mixed fiber, Black / Gray)

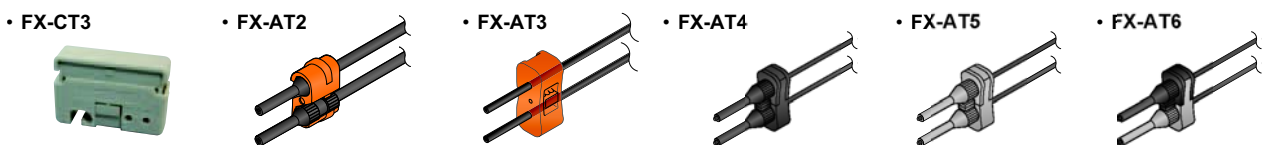
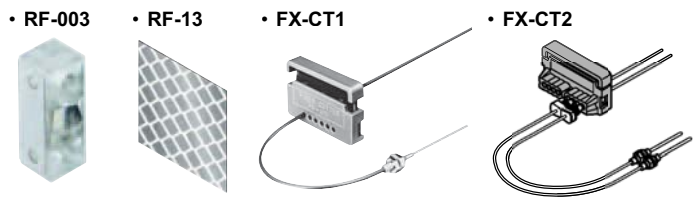

FIBER OPTIONS

Lens (For thru-beam type fiber)

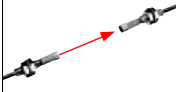
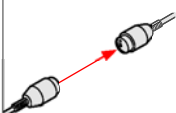
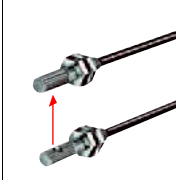
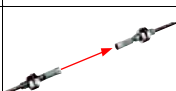
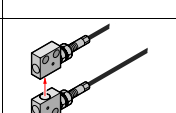
Designation	Model No.	Description																																																																																																										
For thru-beam type fiber	Expansion lens (Note 1)	 <p>FX-LE1</p> <p>Increases the sensing range by 5 times or more.</p> <p>• Ambient temperature: -60 to +350 °C -76 to +662 °F</p> <p>Beam dia: ø3.6 mm ø0.142 in</p>	<p>Sensing range (mm) [Lens on both sides]</p> <table border="1"> <thead> <tr> <th>Fiber \ Mode</th> <th>HYPR</th> <th>U-LG</th> <th>LONG</th> <th>STD</th> <th>FAST</th> <th>H-SP</th> </tr> </thead> <tbody> <tr> <td>FT-B8</td> <td>3,600 (Note 2)</td> <td>3,600 (Note 2)</td> <td>3,600 (Note 2)</td> <td>3,600 (Note 2)</td> <td>3,600 (Note 2)</td> <td>2,000</td> </tr> <tr> <td>FT-FM2</td> <td></td> <td></td> <td></td> <td></td> <td></td> <td></td> </tr> <tr> <td>FT-T80</td> <td></td> <td></td> <td></td> <td></td> <td></td> <td></td> </tr> <tr> <td>FT-R80</td> <td>3,600 (Note 2)</td> <td>3,600 (Note 2)</td> <td>3,600 (Note 2)</td> <td>3,600 (Note 2)</td> <td>3,600 (Note 2)</td> <td>1,400</td> </tr> <tr> <td>FT-W8</td> <td>3,600 (Note 2)</td> <td>3,600 (Note 2)</td> <td>3,600 (Note 2)</td> <td>3,600 (Note 2)</td> <td>3,600 (Note 2)</td> <td>2,100</td> </tr> <tr> <td>FT-P80</td> <td>3,600 (Note 2)</td> <td>3,600 (Note 2)</td> <td>3,600 (Note 2)</td> <td>3,600 (Note 2)</td> <td>3,600 (Note 2)</td> <td>2,500</td> </tr> <tr> <td>FT-P60</td> <td>3,600 (Note 2)</td> <td>3,600 (Note 2)</td> <td>3,600 (Note 2)</td> <td>3,600 (Note 2)</td> <td>3,500</td> <td>1,200</td> </tr> <tr> <td>FT-P81X</td> <td>1,600 (Note 2)</td> <td>1,600 (Note 2)</td> <td>1,600 (Note 2)</td> <td>1,600 (Note 2)</td> <td>1,600 (Note 2)</td> <td>1,500</td> </tr> <tr> <td>FT-H35-M2</td> <td>3,600 (Note 2)</td> <td>3,600 (Note 2)</td> <td>3,600 (Note 2)</td> <td>3,600 (Note 2)</td> <td>3,300</td> <td>1,400</td> </tr> <tr> <td>FT-H20W-M1</td> <td>1,600 (Note 2)</td> <td>1,600 (Note 2)</td> <td>1,600 (Note 2)</td> <td>1,600 (Note 2)</td> <td>1,600 (Note 2)</td> <td>850</td> </tr> <tr> <td>FT-H20-M1</td> <td>1,600 (Note 2)</td> <td>1,600 (Note 2)</td> <td>1,600 (Note 2)</td> <td>1,600 (Note 2)</td> <td>1,600 (Note 2)</td> <td>1,200</td> </tr> <tr> <td>FT-H20-J50-S</td> <td>3,600 (Note 2)</td> <td>3,600 (Note 2)</td> <td>3,500</td> <td>2,000</td> <td>1,600</td> <td>500</td> </tr> <tr> <td>FT-H20-J30-S</td> <td></td> <td></td> <td></td> <td></td> <td></td> <td></td> </tr> <tr> <td>FT-H20-J20-S</td> <td></td> <td></td> <td></td> <td></td> <td></td> <td></td> </tr> </tbody> </table>	Fiber \ Mode	HYPR	U-LG	LONG	STD	FAST	H-SP	FT-B8	3,600 (Note 2)	3,600 (Note 2)	3,600 (Note 2)	3,600 (Note 2)	3,600 (Note 2)	2,000	FT-FM2							FT-T80							FT-R80	3,600 (Note 2)	3,600 (Note 2)	3,600 (Note 2)	3,600 (Note 2)	3,600 (Note 2)	1,400	FT-W8	3,600 (Note 2)	3,600 (Note 2)	3,600 (Note 2)	3,600 (Note 2)	3,600 (Note 2)	2,100	FT-P80	3,600 (Note 2)	3,600 (Note 2)	3,600 (Note 2)	3,600 (Note 2)	3,600 (Note 2)	2,500	FT-P60	3,600 (Note 2)	3,600 (Note 2)	3,600 (Note 2)	3,600 (Note 2)	3,500	1,200	FT-P81X	1,600 (Note 2)	1,600 (Note 2)	1,600 (Note 2)	1,600 (Note 2)	1,600 (Note 2)	1,500	FT-H35-M2	3,600 (Note 2)	3,600 (Note 2)	3,600 (Note 2)	3,600 (Note 2)	3,300	1,400	FT-H20W-M1	1,600 (Note 2)	1,600 (Note 2)	1,600 (Note 2)	1,600 (Note 2)	1,600 (Note 2)	850	FT-H20-M1	1,600 (Note 2)	1,600 (Note 2)	1,600 (Note 2)	1,600 (Note 2)	1,600 (Note 2)	1,200	FT-H20-J50-S	3,600 (Note 2)	3,600 (Note 2)	3,500	2,000	1,600	500	FT-H20-J30-S							FT-H20-J20-S						
	Fiber \ Mode	HYPR	U-LG	LONG	STD	FAST	H-SP																																																																																																					
	FT-B8	3,600 (Note 2)	3,600 (Note 2)	3,600 (Note 2)	3,600 (Note 2)	3,600 (Note 2)	2,000																																																																																																					
	FT-FM2																																																																																																											
	FT-T80																																																																																																											
FT-R80	3,600 (Note 2)	3,600 (Note 2)	3,600 (Note 2)	3,600 (Note 2)	3,600 (Note 2)	1,400																																																																																																						
FT-W8	3,600 (Note 2)	3,600 (Note 2)	3,600 (Note 2)	3,600 (Note 2)	3,600 (Note 2)	2,100																																																																																																						
FT-P80	3,600 (Note 2)	3,600 (Note 2)	3,600 (Note 2)	3,600 (Note 2)	3,600 (Note 2)	2,500																																																																																																						
FT-P60	3,600 (Note 2)	3,600 (Note 2)	3,600 (Note 2)	3,600 (Note 2)	3,500	1,200																																																																																																						
FT-P81X	1,600 (Note 2)	1,600 (Note 2)	1,600 (Note 2)	1,600 (Note 2)	1,600 (Note 2)	1,500																																																																																																						
FT-H35-M2	3,600 (Note 2)	3,600 (Note 2)	3,600 (Note 2)	3,600 (Note 2)	3,300	1,400																																																																																																						
FT-H20W-M1	1,600 (Note 2)	1,600 (Note 2)	1,600 (Note 2)	1,600 (Note 2)	1,600 (Note 2)	850																																																																																																						
FT-H20-M1	1,600 (Note 2)	1,600 (Note 2)	1,600 (Note 2)	1,600 (Note 2)	1,600 (Note 2)	1,200																																																																																																						
FT-H20-J50-S	3,600 (Note 2)	3,600 (Note 2)	3,500	2,000	1,600	500																																																																																																						
FT-H20-J30-S																																																																																																												
FT-H20-J20-S																																																																																																												
Super-expansion lens (Note 1)	 <p>FX-LE2</p> <p>Tremendously increases the sensing range with large diameter lenses.</p> <p>• Ambient temperature: -60 to +350 °C -76 to +662 °F</p> <p>Beam dia: ø9.8 mm ø0.386 in</p>	<p>Sensing range (mm) [Lens on both sides]</p> <table border="1"> <thead> <tr> <th>Fiber \ Mode</th> <th>HYPR</th> <th>U-LG</th> <th>LONG</th> <th>STD</th> <th>FAST</th> <th>H-SP</th> </tr> </thead> <tbody> <tr> <td>FT-B8</td> <td>3,600 (Note 2)</td> <td>3,600 (Note 2)</td> <td>3,600 (Note 2)</td> <td>3,600 (Note 2)</td> <td>3,600 (Note 2)</td> <td>3,600 (Note 2)</td> </tr> <tr> <td>FT-FM2</td> <td></td> <td></td> <td></td> <td></td> <td></td> <td></td> </tr> <tr> <td>FT-R80</td> <td></td> <td></td> <td></td> <td></td> <td></td> <td></td> </tr> <tr> <td>FT-W8</td> <td></td> <td></td> <td></td> <td></td> <td></td> <td></td> </tr> <tr> <td>FT-P80</td> <td></td> <td></td> <td></td> <td></td> <td></td> <td></td> </tr> <tr> <td>FT-P60</td> <td></td> <td></td> <td></td> <td></td> <td></td> <td></td> </tr> <tr> <td>FT-P81X</td> <td>1,600 (Note 2)</td> <td>1,600 (Note 2)</td> <td>1,600 (Note 2)</td> <td>1,600 (Note 2)</td> <td>1,600 (Note 2)</td> <td>1,600 (Note 2)</td> </tr> <tr> <td>FT-H35-M2</td> <td>3,600 (Note 2)</td> <td>3,600 (Note 2)</td> <td>3,600 (Note 2)</td> <td>3,600 (Note 2)</td> <td>3,600 (Note 2)</td> <td>3,600 (Note 2)</td> </tr> <tr> <td>FT-H20W-M1</td> <td>1,600 (Note 2)</td> <td>1,600 (Note 2)</td> <td>1,600 (Note 2)</td> <td>1,600 (Note 2)</td> <td>1,600 (Note 2)</td> <td>1,600 (Note 2)</td> </tr> <tr> <td>FT-H20-M1</td> <td></td> <td></td> <td></td> <td></td> <td></td> <td></td> </tr> <tr> <td>FT-H13-FM2</td> <td>3,600 (Note 2)</td> <td>3,600 (Note 2)</td> <td>3,600 (Note 2)</td> <td>3,600 (Note 2)</td> <td>3,600 (Note 2)</td> <td>3,600 (Note 2)</td> </tr> <tr> <td>FT-H20-J50-S</td> <td>3,600 (Note 2)</td> <td>3,600 (Note 2)</td> <td>3,600 (Note 2)</td> <td>3,600 (Note 2)</td> <td>3,600 (Note 2)</td> <td>3,600 (Note 2)</td> </tr> <tr> <td>FT-H20-J30-S</td> <td></td> <td></td> <td></td> <td></td> <td></td> <td></td> </tr> <tr> <td>FT-H20-J20-S</td> <td></td> <td></td> <td></td> <td></td> <td></td> <td></td> </tr> </tbody> </table>	Fiber \ Mode	HYPR	U-LG	LONG	STD	FAST	H-SP	FT-B8	3,600 (Note 2)	3,600 (Note 2)	3,600 (Note 2)	3,600 (Note 2)	3,600 (Note 2)	3,600 (Note 2)	FT-FM2							FT-R80							FT-W8							FT-P80							FT-P60							FT-P81X	1,600 (Note 2)	1,600 (Note 2)	1,600 (Note 2)	1,600 (Note 2)	1,600 (Note 2)	1,600 (Note 2)	FT-H35-M2	3,600 (Note 2)	3,600 (Note 2)	3,600 (Note 2)	3,600 (Note 2)	3,600 (Note 2)	3,600 (Note 2)	FT-H20W-M1	1,600 (Note 2)	1,600 (Note 2)	1,600 (Note 2)	1,600 (Note 2)	1,600 (Note 2)	1,600 (Note 2)	FT-H20-M1							FT-H13-FM2	3,600 (Note 2)	3,600 (Note 2)	3,600 (Note 2)	3,600 (Note 2)	3,600 (Note 2)	3,600 (Note 2)	FT-H20-J50-S	3,600 (Note 2)	3,600 (Note 2)	3,600 (Note 2)	3,600 (Note 2)	3,600 (Note 2)	3,600 (Note 2)	FT-H20-J30-S							FT-H20-J20-S							
Fiber \ Mode	HYPR	U-LG	LONG	STD	FAST	H-SP																																																																																																						
FT-B8	3,600 (Note 2)	3,600 (Note 2)	3,600 (Note 2)	3,600 (Note 2)	3,600 (Note 2)	3,600 (Note 2)																																																																																																						
FT-FM2																																																																																																												
FT-R80																																																																																																												
FT-W8																																																																																																												
FT-P80																																																																																																												
FT-P60																																																																																																												
FT-P81X	1,600 (Note 2)	1,600 (Note 2)	1,600 (Note 2)	1,600 (Note 2)	1,600 (Note 2)	1,600 (Note 2)																																																																																																						
FT-H35-M2	3,600 (Note 2)	3,600 (Note 2)	3,600 (Note 2)	3,600 (Note 2)	3,600 (Note 2)	3,600 (Note 2)																																																																																																						
FT-H20W-M1	1,600 (Note 2)	1,600 (Note 2)	1,600 (Note 2)	1,600 (Note 2)	1,600 (Note 2)	1,600 (Note 2)																																																																																																						
FT-H20-M1																																																																																																												
FT-H13-FM2	3,600 (Note 2)	3,600 (Note 2)	3,600 (Note 2)	3,600 (Note 2)	3,600 (Note 2)	3,600 (Note 2)																																																																																																						
FT-H20-J50-S	3,600 (Note 2)	3,600 (Note 2)	3,600 (Note 2)	3,600 (Note 2)	3,600 (Note 2)	3,600 (Note 2)																																																																																																						
FT-H20-J30-S																																																																																																												
FT-H20-J20-S																																																																																																												
Side-view lens	 <p>FX-SV1</p> <p>Beam axis is bent by 90°.</p> <p>• Ambient temperature: -60 to +300 °C -76 to +572 °F</p> <p>Beam dia: ø2.8 mm ø0.110 in</p>	<p>Sensing range (mm) [Lens on both sides]</p> <table border="1"> <thead> <tr> <th>Fiber \ Mode</th> <th>HYPR</th> <th>U-LG</th> <th>LONG</th> <th>STD</th> <th>FAST</th> <th>H-SP</th> </tr> </thead> <tbody> <tr> <td>FT-B8</td> <td>3,600 (Note 2)</td> <td>3,300</td> <td>2,800</td> <td>1,600</td> <td>970</td> <td>310</td> </tr> <tr> <td>FT-FM2</td> <td></td> <td></td> <td></td> <td></td> <td></td> <td></td> </tr> <tr> <td>FT-T80</td> <td></td> <td></td> <td></td> <td></td> <td></td> <td></td> </tr> <tr> <td>FT-W8</td> <td>3,600 (Note 2)</td> <td>3,500</td> <td>2,000</td> <td>1,000</td> <td>600</td> <td>250</td> </tr> <tr> <td>FT-P80</td> <td>3,600 (Note 2)</td> <td>3,500</td> <td>2,200</td> <td>1,300</td> <td>790</td> <td>290</td> </tr> <tr> <td>FT-P60</td> <td>3,500</td> <td>1,700</td> <td>1,400</td> <td>800</td> <td>500</td> <td>150</td> </tr> <tr> <td>FT-P81X</td> <td>1,600 (Note 2)</td> <td>1,600 (Note 2)</td> <td>1,600 (Note 2)</td> <td>1,400</td> <td>880</td> <td>280</td> </tr> <tr> <td>FT-H35-M2</td> <td>3,500</td> <td>1,600</td> <td>1,200</td> <td>780</td> <td>500</td> <td>150</td> </tr> <tr> <td>FT-H20W-M1</td> <td>1,600 (Note 2)</td> <td>1,600 (Note 2)</td> <td>1,500</td> <td>950</td> <td>560</td> <td>190</td> </tr> <tr> <td>FT-H20-M1</td> <td>1,600 (Note 2)</td> <td>1,600 (Note 2)</td> <td>1,300</td> <td>780</td> <td>500</td> <td>150</td> </tr> <tr> <td>FT-H20-J50-S</td> <td>1,600 (Note 2)</td> <td>960</td> <td>740</td> <td>450</td> <td>290</td> <td>80</td> </tr> <tr> <td>FT-H20-J30-S</td> <td></td> <td></td> <td></td> <td></td> <td></td> <td></td> </tr> <tr> <td>FT-H20-J20-S</td> <td></td> <td></td> <td></td> <td></td> <td></td> <td></td> </tr> </tbody> </table>	Fiber \ Mode	HYPR	U-LG	LONG	STD	FAST	H-SP	FT-B8	3,600 (Note 2)	3,300	2,800	1,600	970	310	FT-FM2							FT-T80							FT-W8	3,600 (Note 2)	3,500	2,000	1,000	600	250	FT-P80	3,600 (Note 2)	3,500	2,200	1,300	790	290	FT-P60	3,500	1,700	1,400	800	500	150	FT-P81X	1,600 (Note 2)	1,600 (Note 2)	1,600 (Note 2)	1,400	880	280	FT-H35-M2	3,500	1,600	1,200	780	500	150	FT-H20W-M1	1,600 (Note 2)	1,600 (Note 2)	1,500	950	560	190	FT-H20-M1	1,600 (Note 2)	1,600 (Note 2)	1,300	780	500	150	FT-H20-J50-S	1,600 (Note 2)	960	740	450	290	80	FT-H20-J30-S							FT-H20-J20-S														
Fiber \ Mode	HYPR	U-LG	LONG	STD	FAST	H-SP																																																																																																						
FT-B8	3,600 (Note 2)	3,300	2,800	1,600	970	310																																																																																																						
FT-FM2																																																																																																												
FT-T80																																																																																																												
FT-W8	3,600 (Note 2)	3,500	2,000	1,000	600	250																																																																																																						
FT-P80	3,600 (Note 2)	3,500	2,200	1,300	790	290																																																																																																						
FT-P60	3,500	1,700	1,400	800	500	150																																																																																																						
FT-P81X	1,600 (Note 2)	1,600 (Note 2)	1,600 (Note 2)	1,400	880	280																																																																																																						
FT-H35-M2	3,500	1,600	1,200	780	500	150																																																																																																						
FT-H20W-M1	1,600 (Note 2)	1,600 (Note 2)	1,500	950	560	190																																																																																																						
FT-H20-M1	1,600 (Note 2)	1,600 (Note 2)	1,300	780	500	150																																																																																																						
FT-H20-J50-S	1,600 (Note 2)	960	740	450	290	80																																																																																																						
FT-H20-J30-S																																																																																																												
FT-H20-J20-S																																																																																																												
Expansion lens for vacuum fiber (Note 1)	 <p>FV-LE1</p> <p>Sensing range increases by 4 times or more.</p> <p>• Ambient temperature: -60 to +350 °C -76 to +662 °F</p> <p>Beam dia: ø3.6 mm ø0.142 in</p>	<p>Sensing range (mm) [Lens on both sides] (Note 3)</p> <table border="1"> <thead> <tr> <th>Fiber \ Mode</th> <th>HYPR</th> <th>U-LG</th> <th>LONG</th> <th>STD</th> <th>FAST</th> <th>H-SP</th> </tr> </thead> <tbody> <tr> <td>FT-H30-M1V</td> <td>3,600 (Note 2)</td> <td>3,600 (Note 2)</td> <td>3,400</td> <td>1,500</td> <td>900</td> <td>370</td> </tr> </tbody> </table>	Fiber \ Mode	HYPR	U-LG	LONG	STD	FAST	H-SP	FT-H30-M1V	3,600 (Note 2)	3,600 (Note 2)	3,400	1,500	900	370																																																																																												
Fiber \ Mode	HYPR	U-LG	LONG	STD	FAST	H-SP																																																																																																						
FT-H30-M1V	3,600 (Note 2)	3,600 (Note 2)	3,400	1,500	900	370																																																																																																						
Vacuum-resistant side-view lens (Note 1)	 <p>FV-SV2</p> <p>Beam axis is bent by 90°.</p> <p>• Ambient temperature: -60 to +300 °C -76 to +572 °F</p> <p>Beam dia: ø3.7 mm ø0.146 in</p>	<p>Sensing range (mm) [Lens on both sides] (Note 3)</p> <table border="1"> <thead> <tr> <th>Fiber \ Mode</th> <th>HYPR</th> <th>U-LG</th> <th>LONG</th> <th>STD</th> <th>FAST</th> <th>H-SP</th> </tr> </thead> <tbody> <tr> <td>FT-H30-M1V</td> <td>3,600 (Note 2)</td> <td>3,600 (Note 2)</td> <td>3,400</td> <td>1,500</td> <td>900</td> <td>370</td> </tr> </tbody> </table>	Fiber \ Mode	HYPR	U-LG	LONG	STD	FAST	H-SP	FT-H30-M1V	3,600 (Note 2)	3,600 (Note 2)	3,400	1,500	900	370																																																																																												
Fiber \ Mode	HYPR	U-LG	LONG	STD	FAST	H-SP																																																																																																						
FT-H30-M1V	3,600 (Note 2)	3,600 (Note 2)	3,400	1,500	900	370																																																																																																						

Notes: 1) Be careful when installing the thru-beam type fiber equipped with the expansion lens, as the beam envelope becomes narrow and alignment is difficult. Especially when installing a fiber with many cores (sharp bending fibers and heat-resistant glass fiber), please be sure to use it only after you have adjusted it sufficiently.
 2) The fiber cable length practically limits the sensing range to 3,600 mm 141.732 in long (FT-P81X, FT-H20W-M1 and FT-H20-M1: 1,600 mm 62.992 in).
 3) The fiber cable length for the FT-H30-M1V is 1 m 3.281 ft. The sensing ranges in HYPR, U-LG and LONG modes take into account the length of the FT-J8 atmospheric side fiber.

FIBER OPTIONS

Lens (For reflective type fiber)

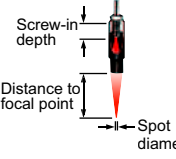
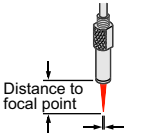
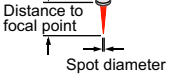
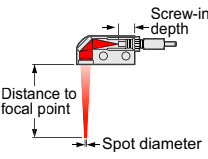
Designation	Model No.	Description															
For reflective type fiber	Pinpoint spot lens	FX-MR1	 <p>Pinpoint spot of $\varnothing 0.5$ mm $\varnothing 0.020$ in. Enables detection of minute objects or small marks.</p> <ul style="list-style-type: none"> Distance to focal point: 6 ± 1 mm 0.236 ± 0.039 in Applicable fibers: FD-WG4, FD-G4 Ambient temperature: -40 to $+70$ °C -40 to $+158$ °F 														
	Zoom lens	FX-MR2	 <p>The spot diameter is adjustable from $\varnothing 0.7$ to $\varnothing 2$ mm $\varnothing 0.028$ to $\varnothing 0.079$ in according to how much the fiber is screwed in.</p> <ul style="list-style-type: none"> Applicable fibers: FD-WG4, FD-G4 Ambient temperature: -40 to $+70$ °C -40 to $+158$ °F Accessory: MS-EX-3 (mounting bracket) <p>Sensing range</p> <table border="1"> <thead> <tr> <th>Screw-in depth</th> <th>Distance to focal point</th> <th>Spot diameter</th> </tr> </thead> <tbody> <tr> <td>7mm</td> <td>18.5 mm approx.</td> <td>$\varnothing 0.7$ mm</td> </tr> <tr> <td>12mm</td> <td>27 mm approx.</td> <td>$\varnothing 1.2$ mm</td> </tr> <tr> <td>14mm</td> <td>43 mm approx.</td> <td>$\varnothing 2.0$ mm</td> </tr> </tbody> </table>	Screw-in depth	Distance to focal point	Spot diameter	7mm	18.5 mm approx.	$\varnothing 0.7$ mm	12mm	27 mm approx.	$\varnothing 1.2$ mm	14mm	43 mm approx.	$\varnothing 2.0$ mm		
	Screw-in depth	Distance to focal point	Spot diameter														
	7mm	18.5 mm approx.	$\varnothing 0.7$ mm														
	12mm	27 mm approx.	$\varnothing 1.2$ mm														
14mm	43 mm approx.	$\varnothing 2.0$ mm															
Finest spot lens	FX-MR3	 <p>Extremely fine spot of $\varnothing 0.3$ mm $\varnothing 0.012$ in approx. achieved.</p> <ul style="list-style-type: none"> Applicable fibers: FD-WG4, FD-G4, FD-EG1, FD-EG2, FD-EG3, FD-G6X, FD-G6 Ambient temperature: -40 to $+70$ °C -40 to $+158$ °F <p>Sensing range</p> <table border="1"> <thead> <tr> <th>Fiber model No.</th> <th>Distance to focal point</th> <th>Spot diameter</th> </tr> </thead> <tbody> <tr> <td>FD-EG3</td> <td>7.5 ± 0.5 mm</td> <td>$\varnothing 0.15$ mm approx.</td> </tr> <tr> <td>FD-EG2</td> <td>7.5 ± 0.5 mm</td> <td>$\varnothing 0.2$ mm approx.</td> </tr> <tr> <td>FD-EG1</td> <td>7.5 ± 0.5 mm</td> <td>$\varnothing 0.3$ mm approx.</td> </tr> <tr> <td>FD-WG4/G4/G6X/G6</td> <td>7.5 ± 0.5 mm</td> <td>$\varnothing 0.5$ mm approx.</td> </tr> </tbody> </table>	Fiber model No.	Distance to focal point	Spot diameter	FD-EG3	7.5 ± 0.5 mm	$\varnothing 0.15$ mm approx.	FD-EG2	7.5 ± 0.5 mm	$\varnothing 0.2$ mm approx.	FD-EG1	7.5 ± 0.5 mm	$\varnothing 0.3$ mm approx.	FD-WG4/G4/G6X/G6	7.5 ± 0.5 mm	$\varnothing 0.5$ mm approx.
Fiber model No.	Distance to focal point	Spot diameter															
FD-EG3	7.5 ± 0.5 mm	$\varnothing 0.15$ mm approx.															
FD-EG2	7.5 ± 0.5 mm	$\varnothing 0.2$ mm approx.															
FD-EG1	7.5 ± 0.5 mm	$\varnothing 0.3$ mm approx.															
FD-WG4/G4/G6X/G6	7.5 ± 0.5 mm	$\varnothing 0.5$ mm approx.															
Finest spot lens	FX-MR6	 <p>Extremely fine spot of $\varnothing 0.1$ mm $\varnothing 0.004$ in approx. achieved.</p> <ul style="list-style-type: none"> Applicable fibers: FD-WG4, FD-G4, FD-EG1, FD-EG2, FD-EG3, FD-G6X, FD-G6 Ambient temperature: -20 to $+60$ °C -4 to $+140$ °F <p>Sensing range</p> <table border="1"> <thead> <tr> <th>Fiber model No.</th> <th>Distance to focal point</th> <th>Spot diameter</th> </tr> </thead> <tbody> <tr> <td>FD-EG3</td> <td>7 ± 0.5 mm</td> <td>$\varnothing 0.1$ mm approx.</td> </tr> <tr> <td>FD-EG2</td> <td>7 ± 0.5 mm</td> <td>$\varnothing 0.15$ mm approx.</td> </tr> <tr> <td>FD-EG1</td> <td>7 ± 0.5 mm</td> <td>$\varnothing 0.2$ mm approx.</td> </tr> <tr> <td>FD-WG4/G4/G6X/G6</td> <td>7 ± 0.5 mm</td> <td>$\varnothing 0.4$ mm approx.</td> </tr> </tbody> </table>	Fiber model No.	Distance to focal point	Spot diameter	FD-EG3	7 ± 0.5 mm	$\varnothing 0.1$ mm approx.	FD-EG2	7 ± 0.5 mm	$\varnothing 0.15$ mm approx.	FD-EG1	7 ± 0.5 mm	$\varnothing 0.2$ mm approx.	FD-WG4/G4/G6X/G6	7 ± 0.5 mm	$\varnothing 0.4$ mm approx.
Fiber model No.	Distance to focal point	Spot diameter															
FD-EG3	7 ± 0.5 mm	$\varnothing 0.1$ mm approx.															
FD-EG2	7 ± 0.5 mm	$\varnothing 0.15$ mm approx.															
FD-EG1	7 ± 0.5 mm	$\varnothing 0.2$ mm approx.															
FD-WG4/G4/G6X/G6	7 ± 0.5 mm	$\varnothing 0.4$ mm approx.															
Zoom lens (side-view type)	FX-MR5	 <p>FX-MR2 is converted into a side-view type and can be mounted in a very small space.</p> <ul style="list-style-type: none"> Applicable fibers: FD-WG4, FD-G4 Ambient temperature: -40 to $+70$ °C -40 to $+158$ °F <p>Sensing range</p> <table border="1"> <thead> <tr> <th>Screw-in depth</th> <th>Distance to focal point</th> <th>Spot diameter</th> </tr> </thead> <tbody> <tr> <td>8 mm</td> <td>13 mm approx.</td> <td>$\varnothing 0.5$ mm</td> </tr> <tr> <td>10 mm</td> <td>15 mm approx.</td> <td>$\varnothing 0.8$ mm</td> </tr> <tr> <td>14 mm</td> <td>30 mm approx.</td> <td>$\varnothing 3.0$ mm</td> </tr> </tbody> </table>	Screw-in depth	Distance to focal point	Spot diameter	8 mm	13 mm approx.	$\varnothing 0.5$ mm	10 mm	15 mm approx.	$\varnothing 0.8$ mm	14 mm	30 mm approx.	$\varnothing 3.0$ mm			
Screw-in depth	Distance to focal point	Spot diameter															
8 mm	13 mm approx.	$\varnothing 0.5$ mm															
10 mm	15 mm approx.	$\varnothing 0.8$ mm															
14 mm	30 mm approx.	$\varnothing 3.0$ mm															

FIBER OPTIONS

Designation	Model No.	Description	
Protective tube (For thru-beam type fiber)	FTP-500 (0.5 m 1.640 ft)	For M4 thread	FT-B8 FT-P80 FT-FM2 FT-P60 FT-FM2S FT-FM2S4
	FTP-1000 (1 m 3.281 ft)		Applicable fibers
	FTP-1500 (1.5 m 4.921 ft)		
	FTP-N500 (0.5 m 1.640 ft)	For M3 thread	
	FTP-N1000 (1 m 3.281 ft)		
	FTP-N1500 (1.5 m 4.921 ft)		
Protective tube (For reflective type fiber)	FDP-500 (0.5 m 1.640 ft)	For M6 thread	FD-B8 FD-P80 FD-FM2 FD-H13-FM2 FD-FM2S
	FDP-1000 (1 m 3.281 ft)		Applicable fibers
	FDP-1500 (1.5 m 4.921 ft)		
	FDP-N500 (0.5 m 1.640 ft)	For M4 thread	
	FDP-N1000 (1 m 3.281 ft)		
	FDP-N1500 (1.5 m 4.921 ft)		
Fiber bender	FB-1	The fiber bender bends the sleeve part of the fiber head at the proper radius. (Note 1)	
Universal sensor mounting stand (Note 2)	MS-AJ1-F	Horizontal mounting type	Mounting stand assembly for fiber (For M3, M4 or M6 threaded head fiber)
	MS-AJ2-F	Vertical mounting type	
Resin nut set	FX-M6N	Applicable fibers	FD-G60
	FX-M4N		FT-F41 FD-G40
Liquid inflow prevention joint (Note 2)	MS-FX-01Y	Applicable fibers	This joint suppresses false operations due to liquid slip-in from the top of the protective tube.
Protective tube extension joint (Note 2)	MS-FX-02Y		FD-HF40Y FD-F41Y
Fiber mounting joint (Note 2)	MS-FX-03Y		The protective tube can be extended.
Single-core holder	FX-AT15A		The joint is used for mounting fibers on a tank.
			The incident light intensity may vary when using a multi-core fiber or a thin type sharp bending fiber. This holder suppresses the variation in the incident light intensity.

Notes: 1) Do not bend the sleeve part of any side-view type fiber or ultra-small diameter head type fiber.
 2) The joint internal ferrule (MS-FX-YF) is available as a spare part. A distorted ferrule may result in leakage.

Protective tube

- FTP-□
- FDP-□



Fiber bender

- FB-1

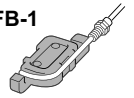

Universal sensor mounting stand

Using the arm which enables adjustment in the horizontal direction, detection can also be done from above an assembly line.

- MS-AJ1-F

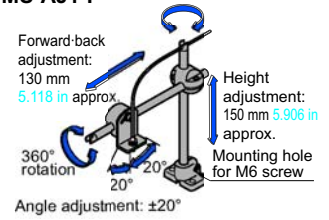

- MS-AJ2-F

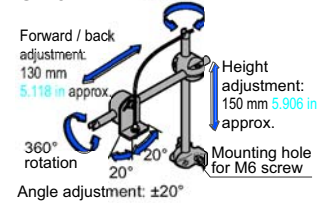

Liquid inflow prevention joint

- MS-FX-01Y

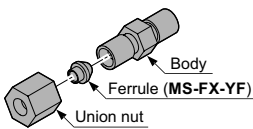

Protective tube extension joint

- MS-FX-02Y

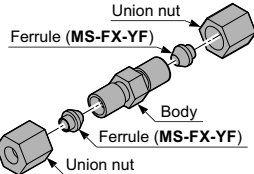

Fiber mounting joint

- MS-FX-03Y

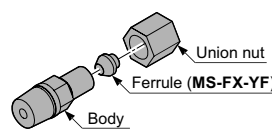

Single-core holder

- FX-AT15A



PRECAUTIONS FOR PROPER USE



- Never use this product as a sensing device for personnel protection.
- In case of using sensing devices for personnel protection, use products which meet laws and standards, such as OSHA, ANSI or IEC etc., for personnel protection applicable in each region or country.

Wiring

- Make sure that the power supply is OFF while adding or removing the amplifiers.
- Note that if a voltage exceeding the reted range is applied, or if an AC power supply is directly connected, the product may get burnt or damaged.
- Note that short-circuit of the load or wrong wiring may burn or damage the product.
- Do not run the wires together with high-voltage lines or power lines, or put them in the same raceway. This can cause malfunction due to induction.
- Verify that the supply voltage variation is within the rating.
- If power is supplied from a commercial switching regulator, ensure that the frame ground (F.G.) terminal of the power supply is connected to an actual ground.
- In case noise generating equipment (switching regulator, inverter motor, etc.) is used in the vicinity of this product, connect the frame ground (F.G.) terminal of the equipment to an actual ground.
- Make sure to use the quick-connection cable (optional) for the connection of the controller.
Extension up to total 100 m 328.084 ft is possible with 0.3 mm² or more, cable.
However, in order to reduce noise, make the wiring as short as possible.
- Make sure that stress by forcible bending or pulling is not applied to the sensor cable joint and fiber cable.

Others

- This product has been developed / produced for industrial use only.
- The specification may not be satisfied in a strong magnetic field.
- The ultra long distance (U-LG, HYPR) mode is more likely to be affected by extraneous noise since the sensitivity of that is higher than the other modes. Make sure to check the environment before use.
- Do not use during the initial transient time (H-SP, FAST, STD: 0.5 sec., LONG, U-LG, HYPR: 1 sec.) after the power supply is switched ON.
- This product is suitable for indoor use only.
- Avoid dust, dirt, and steam.
- Make sure that the product does not come in contact with oil, grease, organic solvents such as thinner, etc., strong acid or alkaline.
- This product cannot be used in an environment containing inflammable or explosive gases.
- Never disassemble or modify this product.
- This product adopts EEPROM. Settings cannot be done 100 thousand times or more because of the EEPROM's lifetime.

Disclaimer

The applications described in the catalog are all intended for examples only. The purchase of our products described in the catalog shall not be regarded as granting of a license to use our products in the described applications. We do NOT warrant that we have obtained some intellectual properties, such as patent rights, with respect to such applications, or that the described applications may not infringe any intellectual property rights, such as patent rights, of a third party.

DIMENSIONS (Unit: mm in)

Super quality fibers • Thru-beam type



FT-30

<with FX-AT2>

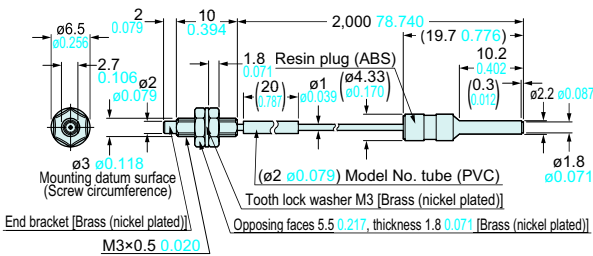

FT-40

<with FX-AT2>

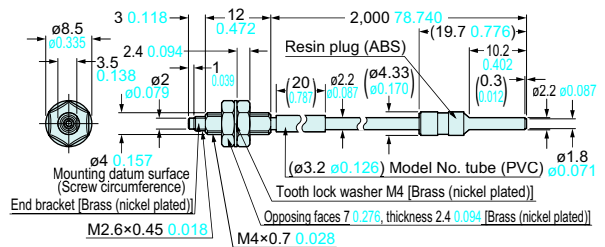

FT-S20

<with FX-AT2>

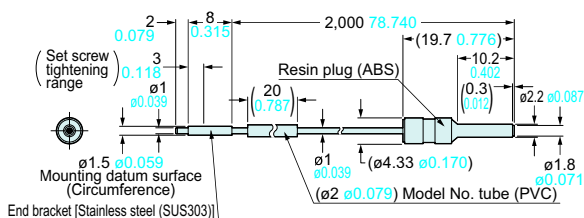

FT-S30

<with FX-AT2>

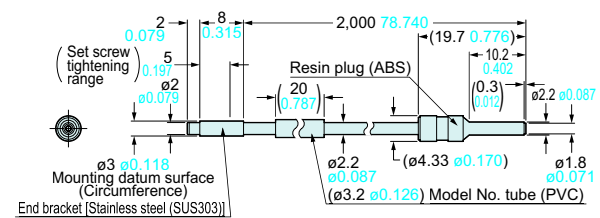

DIMENSIONS (Unit: mm in)

Super quality fibers • Reflective type



FD-30

<with FX-AT2>

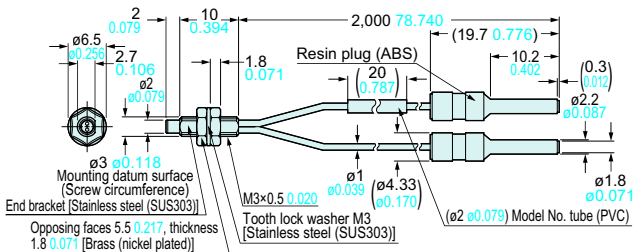

FD-40

<with FX-AT2>

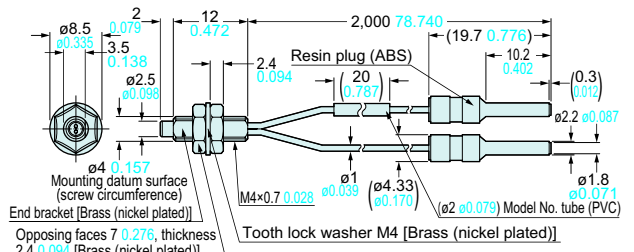

FD-60

<with FX-AT2>

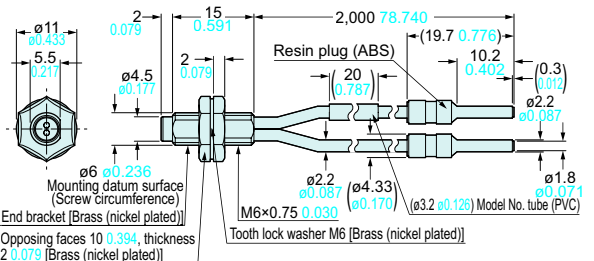

FD-S30

<with FX-AT2>

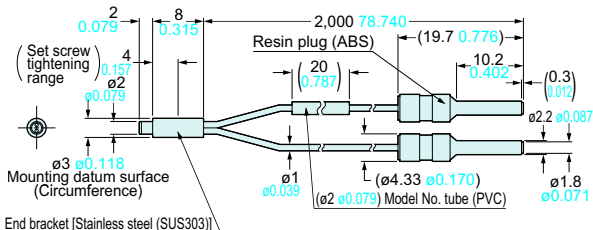

FX-501(P) FX-502(P)

Amplifier

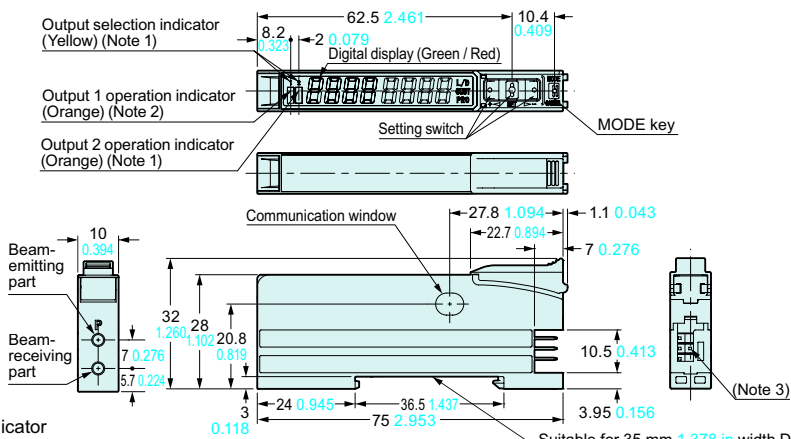

- Notes: 1) FX-502(P) only
- 2) FX-501(P): Operation indicator
- 3) FX-501(P): 3-pin, FX-502(P): 4-pin

FX-505(P)-C2

Amplifier

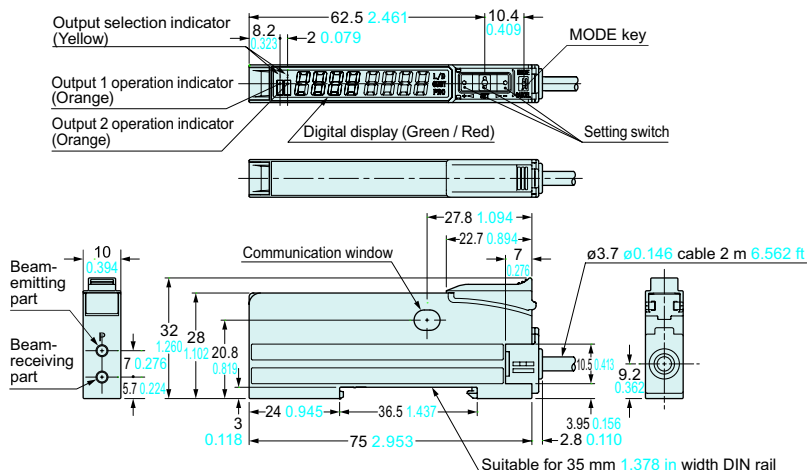

DIMENSIONS (Unit: mm in)

CN-73-C □ CN-74-C □ Main cable (Optional)

• Length L

Model No.	Length L
CN-73/74-C1	1,000 39.370
CN-73/74-C2	2,000 78.740
CN-73/74-C5	5,000 196.850

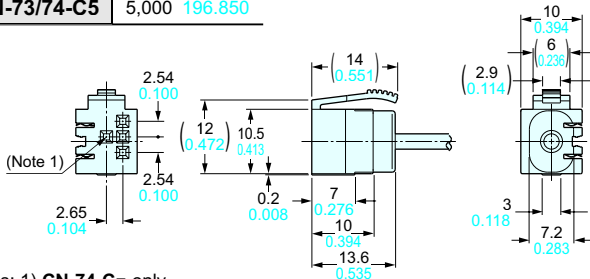
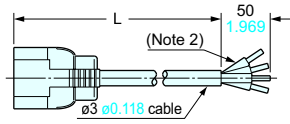

Notes: 1) CN-74-C □ only
2) CN-73-C □: 3-core

CN-71-C □ CN-72-C □ Sub cable (Optional)

• Length L

Model No.	Length L
CN-71/72-C1	1,000 39.370
CN-71/72-C2	2,000 78.740
CN-71/72-C5	5,000 196.850

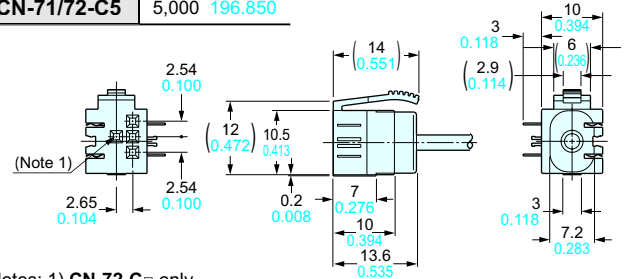
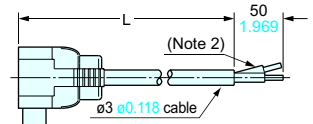

Notes: 1) CN-72-C □ only
2) CN-71-C □: 1-core

MS-DIN-2 Amplifier mounting bracket (Optional)

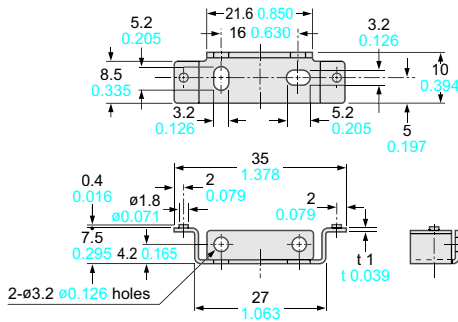

Material: Cold rolled carbon steel (SPCC)
(Uni-chrome plated)

MS-DIN-E End plate (Optional)

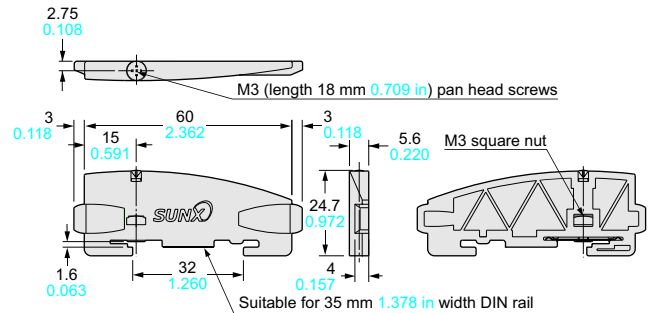

Material: Polycarbonate

<Fiber Sensor Lineup>

Digital fiber sensor FX-100 series

- The digital dual-display is greatly visible in the workplace!
- Commercially-available connectors are used so that lead time and spare part numbers can both be reduced.



Digital fiber sensor (Manually set) FX-410 series

- Simple operation that does not require users to read instruction manuals.
- The beam power has been greatly increased.



All information is subject to change without prior notice.



SUNX Limited
2431-1 Ushiyama-cho, Kasugai-shi, Aichi,
486-0901, Japan
Phone: +81-568-33-7211
FAX: +81-568-33-2631

Overseas Sales Division
Phone: +81-568-33-7861
FAX: +81-568-33-8591

<http://www.sunx.com>