

# ATX-1136H

• **360W**



## Features

- ATX12V Rev. 1.3 & ATX Backward Compliant
- SATA HDD power connector built-in
- High Efficiency
- Power good TTL Signal, Remote On/Off
- Short Circuit, Over Current & Voltage Protection
- Safety Compliant
- IAPC, Wake-On-LAN Technology Ready
- Auto-Sensing Thermal Control
- Low Acoustic Noise

## Apply For

- All Intel Processors up to P4-HT
- All AMD Processors up to Athlon 64/FX



## Electrical Specifications

- Input Voltage 115 ~ 230 VAC Manual Select
- Frequency 50 ~ 60 Hz
- Input current 8.0 Arms @ 115 VAC  
4.5 Arms @ 230 VAC
- Holdup Time > 14 ms @ Full Load

## Environmental Specifications

- Operating/Storage Temp. 10~50°C/-20~60°C
- Operating/Storage Humidity 85% / 95%
- Operating/Storage Altitude 10,000/50,000 FT
- MTBF 100,000 HRS
- Safety Approvals UL/CUL, CB, TUV
- EMC Regulations FCC, CE

## Output Specifications

Voltage	Regulation Load	Minimum Load	Maximum Load	Peak
+3.3V	+/-5%	0.3A	28.0A	--
+5.0V	+/- 5%	0.5A	35.0A	--
+12.0V	+/- 5%	1.0A	18.0A	20.0A
-12.0V	+/- 10%	0A	0.8A	--
+5 Vsb	+/- 5%	0A	2.0A	--

(\*) Total maximum combines load output on +3.3V and +5V rail shall not exceed 230 Watts

ATX12V

# ATX-1136H

Mechanical Drawing

• **360W**

**ATX12V**

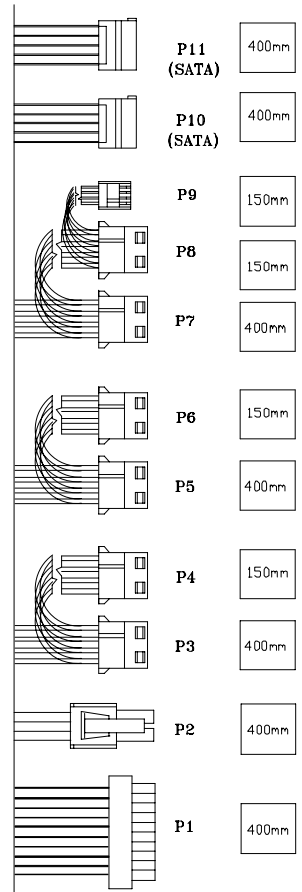
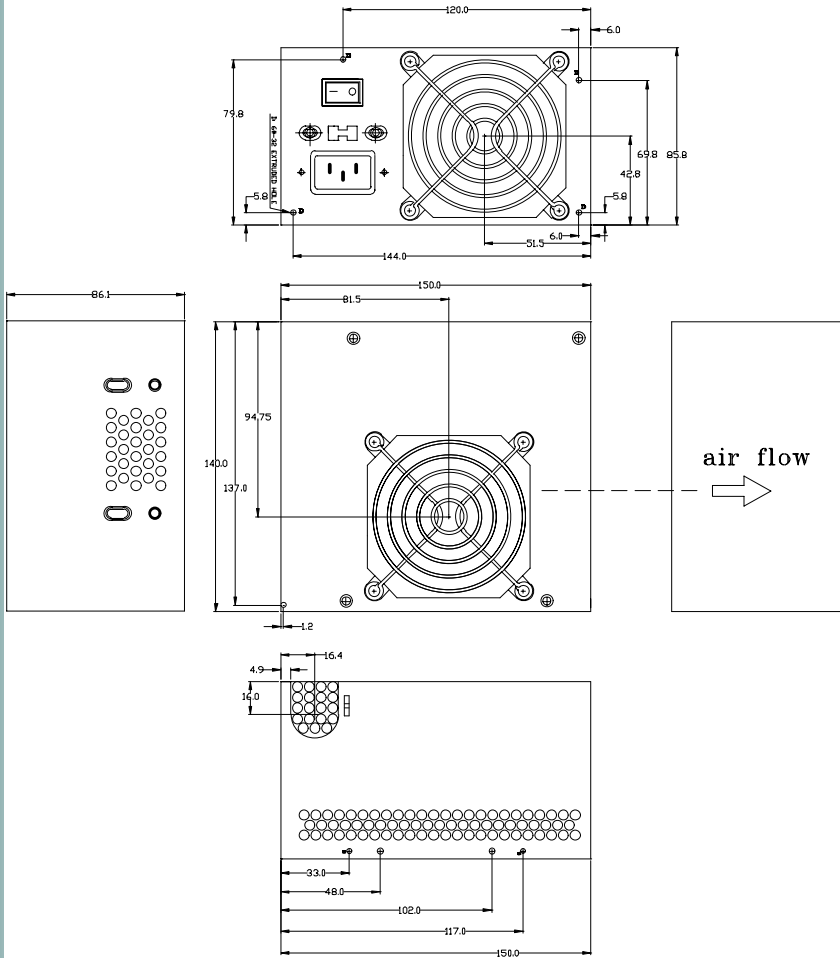

# ATX-1136H

## Wire Harness

• **360W**

### Description

P1 - Main Power

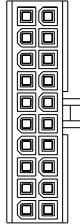

### Connector Housing

Molex 39-01-2200 or Equivalent

1	Orange	+3.3V	11	Orange	+3.3V
2	Orange	+3.3V	12	Blue	-12VDC
3	Black	GND	13	Black	GND
4	Red	+5V	14	Green	PS_ON
5	Black	GND	15	Black	GND
6	Red	+5V	16	Black	GND
7	Black	GND	17	Black	GND
8	Gray	PWR OK	18	NC	Reserved
9	Purple	5 VSB	19	Red	+5V
10	Yellow	+12V	20	Red	+5V

P2 – 4 Pin Processor Power

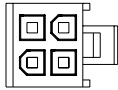

Molex 39-01-2040 or Equivalent

1	Black	GND	3	Yellow	+12V
2	Black	GND	4	Yellow	+12V

P3 to P8 – Peripheral

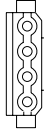

Molex 8981-04P or Equivalent

1	Yellow	+12V
2	Black	GND
3	Black	GND
4	Red	+5V

P9 – Floppy

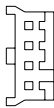

AMP 171822-4 or Equivalent

1	Red	+5V
2	Black	GND
3	Black	GND
4	Yellow	+12V

P10 and P11 – Serial ATA

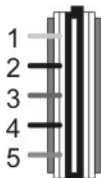

Molex 88751 or Equivalent

1	Yellow	+12V
2	Black	GND
3	Red	+5V
4	Black	GND
5	Orange	+3.3V

### Dimension (WxLxH)

- 150 x 140 x 86 (mm)
- 5.9 x 5.5 x 3.38 (inch)

### Cooling Fan

- 12V DC, 80mm x 2

### Notes

- Specification subject to change without notice. All new processors support will be updated once official announced by vendors
- All company logo and legal name belong to original company. All copyright reserved by Enhance Electronics.
- One-Year Standard Warranty
- Last Update: 5/13/2005

ATX12V