

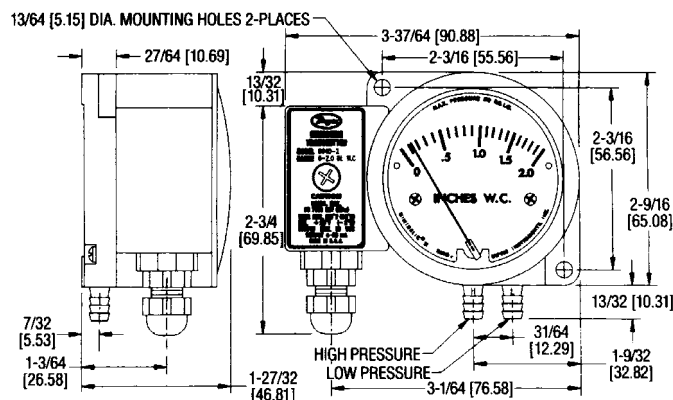

Series 604D Indicating Pressure Transmitter

Specifications - Installation and Operating Instructions



The Dwyer Series 604D Indicating Transmitter simultaneously provides local indication on a compact, easy to read analog scale while also converting that pressure into a standard 2, 3 or 4 wire, 4-20 mA signal for ranges as low as 0-0.5 in. w.c. Positive, negative or differential pressures can be measured within $\pm 5\%$ of full scale (gauge reading) or $\pm 2\%$ of full span output (transmitter signal). The basic mechanical components of the Series 604D units are similar to those used in the popular, time-proven Minihelic® differential pressure gage. However, the Series 604D models add electrical conditioning and amplification of a resistance change produced by an isolated piezoresistive pressure sensor. This resistance change is the result of a slight flexing which results from spring deflection as pressure is applied to the diaphragm which is mechanically linked to the spring.

Series 604D Indicating Transmitter Model & Ranges

Model	Ranges, Inches W.C.	Minor Divisions
604D-0	0-0.5	.02
604D-1	0-1.0	.05
604D-2	0-2.0	.10
604D-3	0-3.0	.10
604D-5	0-5.0	.20
604D-10	0-10	.50
604D-20	0-20	1.0
604D-40	0-40	2.0
604D-60	0-60	2.0
604D-100	0-100	5.0

SPECIFICATIONS

GENERAL

Maximum Pressure: 2 psig for 5 in w.c. or lower ranges; 11 psig for 10 in w.c. or higher ranges.

Media Compatibility: Air and non-combustible, non-corrosive gases.

Materials: Mineral and glass filled nylon housing, high impact acrylic cover, silicone rubber diaphragm.

ELECTRICAL

Power Supply: 10-35 VDC-2,3 or 4 wire 16-26 VAC-4 wire.

Connections: 4 screw terminal block.

Cable Gland: Fits .10 - .25 in (2.5 - 6 mm) O.D. cable.

Output Signal: 4-20 mA DC (limited at 38 mA DC).

Loop Resistance: DC; 0-1300 ohms AC; 0-1200 ohms.

Current Consumption: DC; 38 mA max. AC; 76 mA max.

Warm-Up: 10 minutes.

PERFORMANCE AT 70°F (21.1°C)

Zero Output: 4 mA DC.

Full Span Output: 20 mA DC.

Accuracy, Gage: $\pm 5\%$ of full scale.

Accuracy, Transmitter: $\pm 2\%$ of full span output (Includes linearity, hysteresis and repeatability).

Stability: 1% F.S./year.

ENVIRONMENTAL

Operating Temperature: 20-120°F (-6.7° to 49°C).

Thermal Errors: $\pm 1\%/50^\circ\text{F}$.

MECHANICAL

Weight: 8 oz (227 grams).

Span and Zero: Internally accessible potentiometers.

Pressure Connections: Barbed, for 3/16" (4-5 mm) I.D. tubing.

STANDARD ACCESSORIES

(2) #10 x 1" pan head sheet metal screws, (1) .050" hex allen wrench.

INSTALLATION

LOCATION: Select a location where temperature of the unit will be between 20°F and 120°F (7°C and 49°C). Distance from the receiver is limited only by total loop resistance. See “Electrical Connections.” The tubing feeding pressure to the instrument can be run practically any length required, but long lengths will slightly increase response time. Avoid surfaces with excessive vibration.

POSITION: All models are calibrated with the scale in a vertical plane and units with ranges under 5 in. w.c. should only be used in that position due to the sensitivity to gravitational forces which cannot be corrected by zero adjustment. Higher range models can operate in other planes but zero (both mechanical electrical) and span adjustments may be necessary to maintain accuracy.

PRESSURE CONNECTIONS: Two barbed connectors are provided for use with 3/16” I.D. vinyl or rubber tubing. Attach tubing from positive pressure source to HI port. Leave LO port vented. For negative (vacuum) pressure, connect to LO port and leave HI port vented. For differential pressures, connect the higher to HI port and lower to LO port.

MOUNTING: Attach the Series 604D Indicating Transmitter to a vertical surface using the 1” - #10 pan head sheet metal screws provided. Mounting holes are located in upper left and lower right corners of case.

GAGE ZEROING:

After installation, check to confirm that gage reads exactly zero with both pressure connections open and vented to atmosphere. If adjustment is necessary, grip case firmly with one hand and place palm of the other hand flat on clear cover. If difficult to grip, try placing a thin sheet of rubber between hand and cover. Rotate counter-clockwise to remove. Zero adjust screw is located at bottom of scale just to left of the indicating pointer and slightly behind it. Use the .050” hex allen wrench included. Replace cover.

ELECTRICAL CONNECTIONS

CAUTION: DO NOT EXCEED SPECIFIED SUPPLY VOLTAGE RATINGS. PERMANENT DAMAGE NOT COVERED BY WARRANTY WILL RESULT. THIS UNIT IS NOT DESIGNED FOR 120 VAC or 240 VAC LINE OPERATION.

Electrical connections to the Series 604D Indicating Transmitter are made inside the enclosure on the left side of the unit. Remove the cover and feed 4 conductor cable through the cable gland at bottom of housing. Make electrical connections to the 4-screw terminal block shown in Fig. B. See following instructions and drawings for details on your specific application. When connections are complete, tighten cable gland and replace cover.

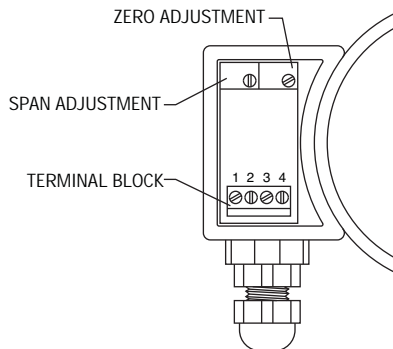

Fig. B

Wire Length - The maximum length of wire connecting transmitter and receiver is a function of wire size and receiver resistance. Wiring should not contribute more than 10% of receiver resistance to total loop resistance. For extremely long runs (over 1000 ft. [305 m]), choose receivers with higher resistances to minimize size and cost of connecting leads. Where wiring length is under 100 ft. (30.48 m), lead wire as small as 22 AWG can be used.

2-Wire Operation - An external power supply delivering 10-35 VDC with minimum current capability of 40 mA DC (per transmitter) must be used to power the control loop. See Fig. C for connection of the power supply, transmitter and receiver. Note the jumper between terminals 3 and 4. The range of appropriate receiver load resistance (R_L) for the DC power supply voltage available is expressed by the formula and graph in Fig. F. Shielded two wire cable is recommended for control loop wiring. If grounding is required use negative side of control loop after receiver. In Fig.C below, if power supply lead to terminal 1 is positive, ground should be connected to wiring at right of receiver. Otherwise, in 2 wire operation it is not necessary to observe polarity of control loop connections.

2-WIRE CONNECTION

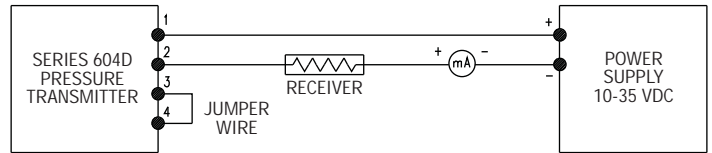

Fig. C

3-Wire Operation - An external power supply delivering 10-35 VDC with minimum current capability of 40 mA DC (per transmitter) is required. See Fig. D for connection of power supply, transmitter and receiver. The range of appropriate receiver load resistance (R_L) for the DC power supply available is expressed by the formula and graph in Fig. F. Shielded cable is recommended for control loop wiring. Do not employ a separate ground in 3 wire operation. Unit will not function properly and/or damage could result. Control loop polarity must be observed in the following respect. Although power supply terminals 1 and 2 are not polarized, the receiver must be connected between terminal 4 of transmitter and negative side of power supply.

3-WIRE CONNECTION

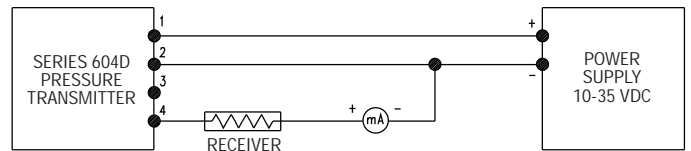
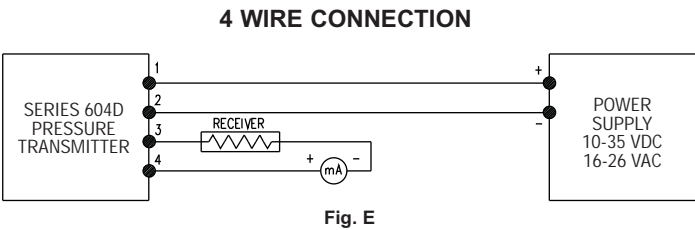
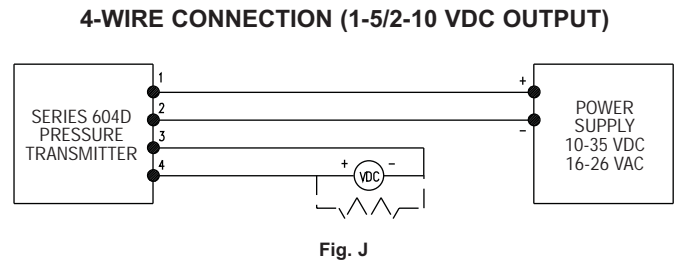
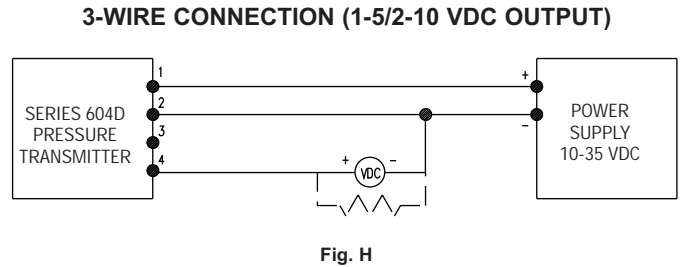

Fig. D

4-Wire Operation - An external power supply delivering 10-35 VDC with minimum current capability of 40 mA DC (per transmitter) or 16-26 VAC with minimum current capability of 80 mA AC (per transmitter) is required. See Fig. E for connection of power supply, transmitter and receiver. The range of appropriate load resistance (R_L) for the DC or AC power supply available is expressed by the formulas and graphs in Figs. F and G. Shielded cable is recommended for control loop wiring. Do not employ a separate ground in 4 wire operation. Unit will not function properly and /or damage could result. Control loop polarity must be observed, terminal 3 is negative and terminal 4 is positive. Power supply terminals 1 and 2 are not polarized.



Voltage Input - Series 604D Indicating Pressure Transmitters can be easily adapted for receivers requiring 1-5 VDC or 2-10 VDC input. Insert a 249 OHM, 1/2 watt (1-5 VDC) or 499 ohm (2-10 VDC) resistor in series with the current loop but in parallel with the receiver input. Locate this resistor as close as possible to the input. Because resistor accuracy directly influences output signal accuracy, we recommend use of a precision $\pm 0.1\%$ tolerance resistor to minimize this effect. See Figs. H and J.



POWER SUPPLY VOLTAGE-VDC (2, 3, OR 4 wire)

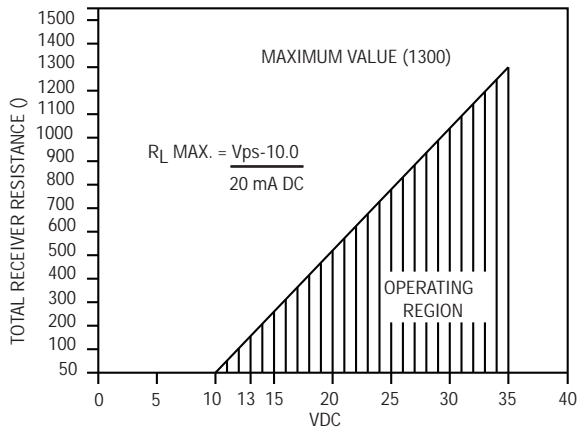

Fig. F

POWER SUPPLY VOLTAGE-VAC (4 wire)

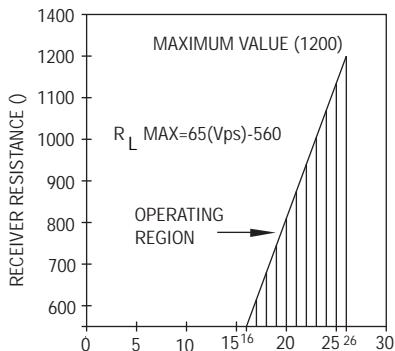

Fig. G

OUTPUT RANGING

Each Series 604D Indicating Transmitter is factory calibrated to produce 4 mA at zero scale reading and 20 mA at full scale reading. The following procedure should be used to check the accuracy of the transmitter output.

1. With unit connected to its companion receiver, insert an accurate milliammeter with a full scale reading of approximately 30 mA in series with the current loop.
2. Connect a controllable source of pressure to one leg of a tee, one leg to the high pressure port of the unit being tested and the third leg to a test gage or manometer with 2% or better accuracy. Be sure the low pressure port is vented to atmosphere. This calibration check must be done in the same position in which the unit will be operated. Vertical is recommended.
3. Apply electrical power to the system and allow 10 minutes warm-up time for components to stabilize.
4. With no pressure applied to the system adjust ZERO control inside electrical enclosure to produce exactly 4 mA current.
5. Apply full scale pressure as observed on the test gage or manometer and adjust SPAN control for exactly 20 mA current.
6. ZERO and SPAN controls are slightly interactive so steps 4 and 5 should be repeated until outputs are consistently 4 and 20 mA, respectively.
7. Remove the milliammeter and test gage from the setup, make connections to system pressure source(s) and place unit in service.

MULTIPLE RECEIVER INSTALLATION

An advantage of the standard 4-20 mA DC output signal used in Series 604D Transmitters is the compatibility with a wide range of receivers. Devices such as the A-701 Digital Readout, A-702 Digital Readout with alarms, an analog panel meter, a chart recorder and other process control equipment can be operated simultaneously. It is only necessary that all devices be designed for a standard 4-20 mA input, the proper polarity of input connections be observed and the combined receiver resistances must not exceed the maximum for the current loop. If any receiver indicates a negative or downscale reading, the signal input leads are reversed.

MAINTENANCE

After final installation of the Series 604D Indicating Pressure Transmitter, no routine maintenance is required. A periodic check of output calibration is recommended following the procedure described under OUTPUT RANGING. Otherwise, the transmitters are not field repairable and should be returned, freight prepaid, to the address below if service is needed. Be sure to include a clear description of the problem plus any application information available.

Dwyer Instruments, Inc.
Attn: Repair Dept.
102 Highway 212
Michigan City, IN 46360