

REVISIONS

ZONE	REV	DESCRIPTION	DATE	APPROVED
	A	ECN 0642	14-JAN-08	
	B	ECN 0652	07-MAY-08	
	C	ECN 0673	09-APR-09	
	D	ECN 0688	08-JUN-10	

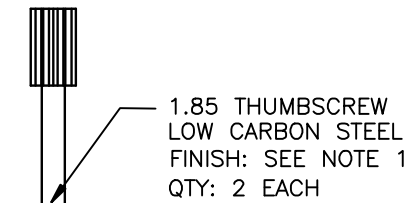
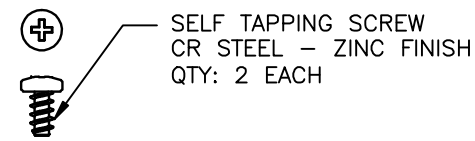
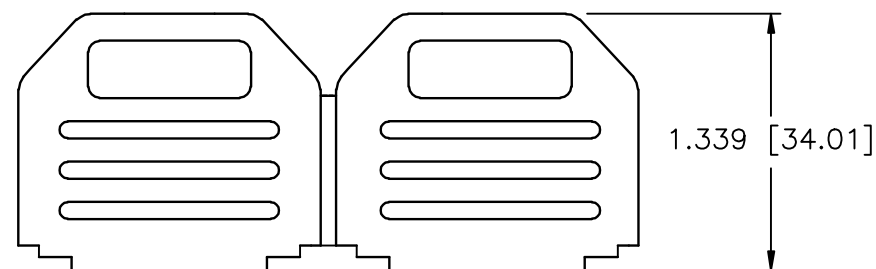
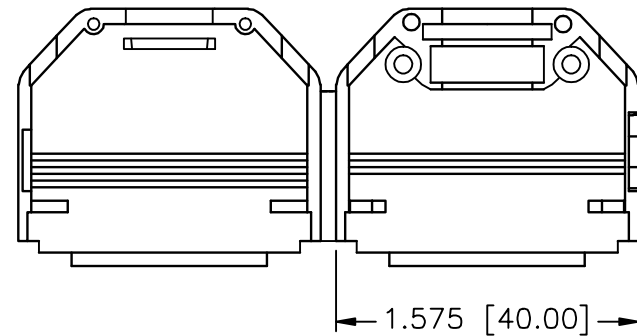
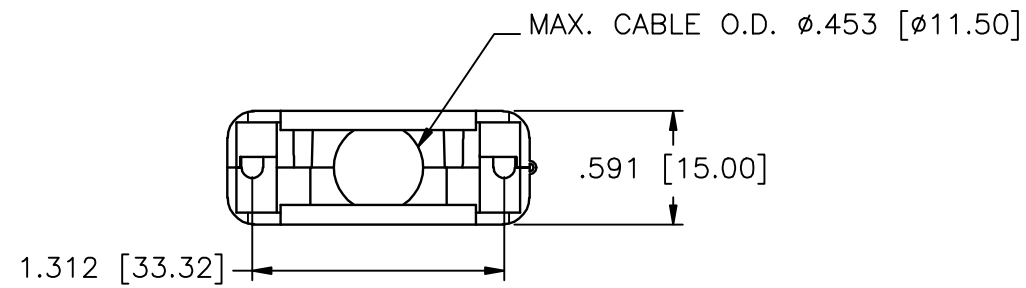

THREAD TYPE-SEE ORDER INFORMATION

NOTE 1:
 4-40 THUMBSCREW FINISH: BLACK
 M2.5 THUMBSCREW FINISH: CLEAR ZINC
 M2.6 THUMBSCREW FINISH: CLEAR ZINC
 M3 THUMBSCREW FINISH: CLEAR ZINC

CONNECTOR COVER:
 1.MATERIAL: POLYAMID UL94HB
 2.DIMENSIONS: INCHES [MM]
 3.TOLERANCE: ±0.015 [0.381]

INSERT
 1.MATERIAL: POLYAMID UL94HB
 2.DIMENSIONS: INCHES [MM]
 3.TOLERANCE: ±0.015 [0.381]

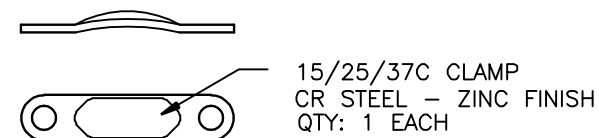
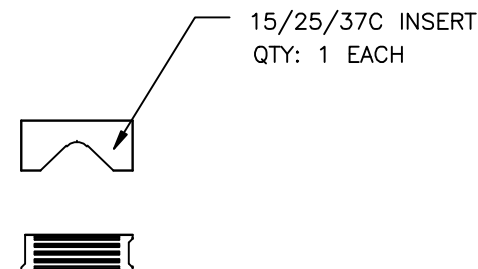

THIS IS A CONTROLLED DOCUMENT AND IS SUBJECT TO CHANGE. CONTACT NORTHERN TECHNOLOGIES ENGINEERING FOR THE LATEST REVISION.

UNLESS OTHERWISE SPECIFIED 1. ALL DIMENSIONS ARE IN INCHES (MM) 2. DIMENSIONS ARE TYPICAL		Northern Technologies <small>THIS DRAWING IS THE PROPERTY OF NORTHERN TECHNOLOGIES AND SHOULD NOT BE REPRODUCED WITHOUT NORTHERN TECHNOLOGIES WRITTEN PERMISSION.</small>		
DRAWN JSD 04-MAY-05		PART NUMBER SEE PART NUMBER INFORMATION		
CHECKED SCN 04-MAY-05		DESCRIPTION CP 15 ONE PIECE PLASTIC W/ THUMBSCREWS		
ISSUED 04-MAY-05	SCALE N.T.S.	SIZE B	CODE 200_148	DWG NO. 0002-200-148
				REV
				SHEET 1 OF 2

PART NUMBER INFORMATION

COLOR	PART#	THUMBSCREW	LOGO STYLE	SUPPLIED
BLACK	MHDEPPK15BLACK	#4-40	NO LOGO	BULK
BLACK	MHDEPPK15BLACKK	#4-40	NO LOGO	PACKAGED
BLACK	MHDEPPK15BLACKKM25	M2.5	NO LOGO	PACKAGED
BLACK	MHDEPPK15BLACKKM26	M2.6	NO LOGO	PACKAGED
BLACK	MHDEPPK15BLACKKM3	M3	NO LOGO	PACKAGED

COLOR	PART#	THUMBSCREW	LOGO STYLE	SUPPLIED
BLUE	MHDEPPK15BLUEK	#4-40	NO LOGO	PACKAGED
BLUE	MHDEPPK15BLUEKM25	M2.5	NO LOGO	PACKAGED
BLUE	MHDEPPK15BLUEKM26	M2.6	NO LOGO	PACKAGED
BLUE	MHDEPPK15BLUEKM3	M3	NO LOGO	PACKAGED

COLOR	PART#	THUMBSCREW	LOGO STYLE	SUPPLIED
GREY	MHDEPPK15GREYK	#4-40	NO LOGO	PACKAGED
GREY	MHDEPPK15GREYKM25	M2.5	NO LOGO	PACKAGED
GREY	MHDEPPK15GREYKM26	M2.6	NO LOGO	PACKAGED
GREY	MHDEPPK15GREYKM3	M3	NO LOGO	PACKAGED

COLOR	PART#	THUMBSCREW	LOGO STYLE	SUPPLIED
YELLOW	MHDEPPK15YELLOWK	#4-40	NO LOGO	PACKAGED
YELLOW	MHDEPPK15YELLOWKM25	M2.5	NO LOGO	PACKAGED
YELLOW	MHDEPPK15YELLOWKM26	M2.6	NO LOGO	PACKAGED
YELLOW	MHDEPPK15YELLOWKM3	M3	NO LOGO	PACKAGED

COLOR	PART#	THUMBSCREW	LOGO STYLE	SUPPLIED
DARK GREY	MHDEPPK15DGREYK	#4-40	NO LOGO	PACKAGED
DARK GREY	MHDEPPK15DGREYKM25	M2.5	NO LOGO	PACKAGED
DARK GREY	MHDEPPK15DGREYKM26	M2.6	NO LOGO	PACKAGED
DARK GREY	MHDEPPK15DGREYKM3	M3	NO LOGO	PACKAGED

COLOR	PART#	THUMBSCREW	LOGO STYLE	SUPPLIED
GREEN	MHDEPPK15GREENK	#4-40	NO LOGO	PACKAGED
GREEN	MHDEPPK15GREENKM25	M2.5	NO LOGO	PACKAGED
GREEN	MHDEPPK15GREENKM26	M2.6	NO LOGO	PACKAGED
GREEN	MHDEPPK15GREENKM3	M3	NO LOGO	PACKAGED

COLOR	PART#	THUMBSCREW	LOGO STYLE	SUPPLIED
RED	MHDEPPK15REDK	#4-40	NO LOGO	PACKAGED
RED	MHDEPPK15REDKM25	M2.5	NO LOGO	PACKAGED
RED	MHDEPPK15REDKM26	M2.6	NO LOGO	PACKAGED
RED	MHDEPPK15REDKM3	M3	NO LOGO	PACKAGED

COLOR	PART#	THUMBSCREW	LOGO STYLE	SUPPLIED
WHITE	MHDEPPK15WHITEK	#4-40	NO LOGO	PACKAGED
WHITE	MHDEPPK15WHITEKM25	M2.5	NO LOGO	PACKAGED
WHITE	MHDEPPK15WHITEKM26	M2.6	NO LOGO	PACKAGED
WHITE	MHDEPPK15WHITEKM3	M3	NO LOGO	PACKAGED

THIS IS A CONTROLLED DOCUMENT AND IS SUBJECT TO CHANGE. CONTACT NORTHERN TECHNOLOGIES ENGINEERING FOR THE LATEST REVISION.

UNLESS OTHERWISE SPECIFIED 1. ALL DIMENSIONS ARE IN INCHES (MM) 2. DIMENSIONS ARE TYPICAL		Northern Technologies <small>THIS DRAWING IS THE PROPERTY OF NORTHERN TECHNOLOGIES AND SHOULD NOT BE REPRODUCED WITHOUT NORTHERN TECHNOLOGIES WRITTEN PERMISSION.</small>	
DRAWN JSD		04-MAY-05	
CHECKED SCN		04-MAY-05	
ISSUED		04-MAY-05	
PART NUMBER SEE PART NUMBER INFORMATION		DESCRIPTION CP 15 ONE PIECE PLASTIC W/ THUMBSCREWS	
SIZE B	CODE 200_148	DWG NO. 0002-200-148	REV
SCALE N.T.S.		SHEET 2 OF 2	