

PCA-6654/6654L

Video Display Card for Flat
Panel and CRT

Copyright Notice

This document is copyrighted by Advantech Co., Ltd. All rights are reserved. Advantech Co., Ltd. reserves the right to make improvements to the products described in this manual at any time without notice.

No part of this manual may be reproduced, copied, translated, or transmitted in any form or by any means without the prior written permission of Advantech Co., Ltd. Information provided in this manual is intended to be accurate and reliable. However, Advantech Co., Ltd. assumes no responsibility for its use, nor for any infringements upon the rights of third parties which may result from its use.

All brand and product names mentioned herein are trademarks or registered trademarks of their respective holders.

Warning: Do not set "V/H SYNC+Blank" in the Award BIOS of your CPU card.



If the Video Off Method of POWER MANAGEMENT SETUP in the Award BIOS is set on "V/H SYNC+Blank", the VGA chip 65550 on board the PCA-6654/6654L will not work properly after woken from power saving mode.

Part No. 2002665400

1st Edition Printed in Taiwan July 1998

Packing List

Before you set up the PCA-6654/6654L, make sure that the following materials have been included with the package, and that this manual is in good condition. If anything is missing or damaged, contact your dealer immediately:

- PCA-6654/6654L card
- PCA-6654/6654L User's Manual
- PCA-6654/6654L installation driver

Introduction

PCA-6654

This is the standard version of the video display card. It contains PanelLink features, which enables it to be used with Advantech's FPM receiver series, including the FPM-37 and FPM-40.

PCA-6654L

This is the localized version of the video display card. It does not contain PanelLink features. It has only one port for connection to an LCD.

PCA-6654 Board Layout

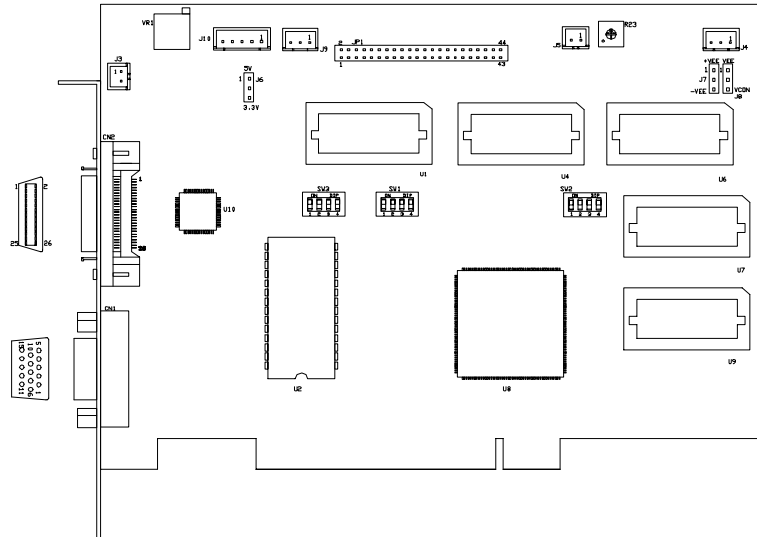

PCA-6654L Board Layout

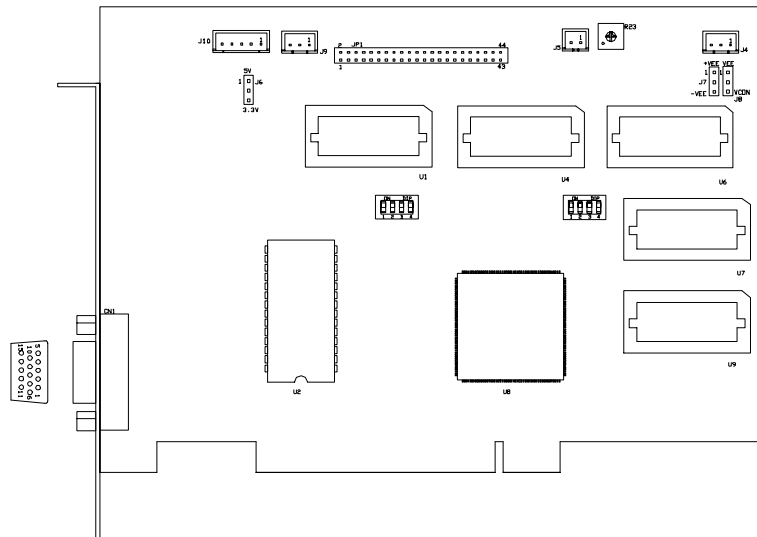

Additional Information and Assistance

1. Visit the Advantech web sites at **www.advantech.com** or **www.advantech.com.tw** where you can find the latest information about the product.
2. Contact your distributor, sales representative, or Advantech's customer service center for technical support if you need additional assistance. Please have the following information ready:
 - Product name and serial number
 - Description of your peripheral attachments
 - Description of your software (operating system, version, application software, etc.)
 - Complete description of the problem
 - Exact wording of any error messages

Safety Instructions

1. Read these safety instructions carefully.
2. Keep this user's manual for later reference.
3. Disconnect this equipment from any AC outlet before cleaning. Do not use liquid or spray detergents for cleaning. Use a damp cloth.
4. For pluggable equipment, the power outlet must be installed near the equipment and must be easily accessible.
5. Keep this equipment away from humidity.
6. Put this equipment on a reliable surface during installation. Dropping it or letting it fall could cause damage.
7. The openings on the enclosure are for air convection. Protect the equipment from overheating. **DO NOT COVER THE OPENINGS.**
8. Make sure the voltage of the power source is correct before connecting the equipment to the power outlet.
9. Position the power cord so that people cannot step on it. Do not place anything over the power cord.
10. All cautions and warnings on the equipment should be noted.
11. If the equipment is not used for a long time, disconnect it from the power source to avoid damage by transient over-voltage.
12. Never pour any liquid into an opening. This could cause fire or electrical shock.
13. Never open the equipment. For safety reasons, the equipment should be opened only by qualified service personnel.
14. If any of the following situations arises, get the equipment checked by service personnel:
 - a. The power cord or plug is damaged.
 - b. Liquid has penetrated into the equipment.
 - c. The equipment has been exposed to moisture.
 - d. The equipment does not work well, or you cannot get it to work according to the user's manual.
 - e. The equipment has been dropped and damaged.
 - f. The equipment has obvious signs of breakage.
15. **DO NOT LEAVE THIS EQUIPMENT IN AN UNCONTROLLED ENVIRONMENT WHERE THE STORAGE TEMPERATURE IS BELOW -20° C (-4° F) OR ABOVE 60° C (140° F). IT MAY DAMAGE THE EQUIPMENT.**

The sound pressure level at the operator's position according to IEC 704-1:1982 is equal to or less than 70 dB(A).

DISCLAIMER: This set of instructions is given according to IEC 704-1. Advantech disclaims all responsibility for the accuracy of any statements contained herein.

Wichtige Sicherheitshinweise

1. Bitte lesen sie Sich diese Hinweise sorgfältig durch.
2. Heben Sie diese Anleitung für den späteren Gebrauch auf.
3. Vor jedem Reinigen ist das Gerät vom Stromnetz zu trennen. Verwenden Sie Keine Flüssig-oder Aerosolreiniger. Am besten dient ein angefeuchtetes Tuch zur Reinigung.
4. Die Netzanschlussteckdose soll nahe dem Gerät angebracht und leicht zugänglich sein.
5. Das Gerät ist vor Feuchtigkeit zu schützen.
6. Bei der Aufstellung des Gerätes ist auf sicheren Stand zu achten. Ein Kippen oder Fallen könnte Verletzungen hervorrufen.
7. Die Belüftungsöffnungen dienen zur Luftzirkulation die das Gerät vor überhitzung schützt. Sorgen Sie dafür, daB diese Öffnungen nicht abgedeckt werden.
8. Beachten Sie beim AnschluB an das Stromnetz die AnschluBwerte.
9. Verlegen Sie die Netzanschlusbleitung so, daB niemand darüber fallen kann. Es sollte auch nichts auf der Leitung abgestellt werden.
10. Alle Hinweise und Warnungen die sich am Geräten befinden sind zu beachten.
11. Wird das Gerät über einen längeren Zeitraum nicht benutzt, sollten Sie es vom Stromnetz trennen. Somit wird im Falle einer Überspannung eine Beschädigung vermieden.
12. Durch die Lüftungsöffnungen dürfen niemals Gegenstände oder Flüssigkeiten in das Gerät gelangen. Dies könnte einen Brand bzw. elektrischen Schlag auslösen.
13. Öffnen Sie niemals das Gerät. Das Gerät darf aus Gründen der elektrischen Sicherheit nur von autorisiertem Servicepersonal geöffnet werden.
14. Wenn folgende Situationen auftreten ist das Gerät vom Stromnetz zu trennen und von einer qualifizierten Servicestelle zu überprüfen:
 - a - Netzkabel oder Netzstecker sind beschädigt.
 - b - Flüssigkeit ist in das Gerät eingedrungen.
 - c - Das Gerät war Feuchtigkeit ausgesetzt.
 - d - Wenn das Gerät nicht der Bedienungsanleitung entsprechend funktioniert oder Sie mit Hilfe dieser Anleitung keine Verbesserung erzielen.
 - e - Das Gerät ist gefallen und/oder das Gehäuse ist beschädigt.
 - f - Wenn das Gerät deutliche Anzeichen eines Defektes aufweist.

Der arbeitsplatzbezogene Schalldruckpegel nach DIN 45 635 Teil 1000 beträgt 70dB(A) oder weiger.

DISCLAIMER: This set of instructions is given according to IEC704-1. Advantech disclaims all responsibility for the accuracy of any statements contained herein.

Contents

Chapter 1 Introduction	1
1.1 Description	2
1.2 Specifications	3
1.3 Driver Support	4
1.4 Utility Support	5
1.5 Video BIOS	5
1.6 Simultaneous Display Mode	6
Chapter 2 Hardware Setup	7
2.1 Hardware Configuration	8
2.2 Jumpers and Connectors	9
Setting jumpers	9
2.3 Jumpers, Connectors and Switches	10
2.4 Connectors for Adjuster	10
J4	10
J5	10
J9	10
2.5 Board Layout - Jumpers, Connectors and Switches	10
2.6 Jumper and Switch Settings	12
2.6.1 LCD signal level select (J6)	12
2.6.2 LCD bias voltage select (MONO) (J7)	12
2.6.3 LCD bias voltage select (J8)	13
2.6.4 LCD type select (SW1)	13
2.6.5 LCD clock configuration select (for PanelLink only) (SW2)	14
2.6.6 LCD control signal configuration select (for PanelLink only) (SW3)	14
2.7 LCD Setup	15
2.7.1 Preliminary	15
2.7.2 TFT LCD Setup	16
2.7.3 DSTN LCD Setup	18
2.7.4 MONO LCD Setup	21

Chapter 3 Software Installation	25
3.1 Simultaneous Display Mode	26
3.2 Installation for Windows 95	27
3.3 Installation for Windows NT	30
3.4 Installation for OS/2	32
3.5 Further Information	35
Chapter 4 FPM Receiver Setup (PanelLink) (for PCA-6654 only)	37
4.1 Introduction	38
4.2 Jumpers and Connectors	39
Setting jumpers	39
4.3 Connectors	40
4.4 Connectors for Adjuster	40
J1	40
J2	40
J7	40
4.5 Board Layout - Connectors	41
4.6 Jumpers and Switches	42
4.7 Board Layout - Jumpers and Switches	43
4.8 Jumper and Switch Settings	44
4.8.1 LCD bias voltage select (J5)	44
4.8.2 LCD signal level select (J8)	44
4.8.3 LCD bias voltage select (MONO) (J13)	45
4.8.4 LCD input clock select (J14)	45
4.8.5 Backlight level select (J15)	45
4.8.6 Power down select (J16)	46
4.8.7 LCD type select (S1)	46
4.8.8 LCD clock configuration select (S2)	47
4.9 LCD Setup	48
4.9.1 Preliminary	48
4.9.2 TFT LCD Setup	49
4.9.3 DSTN LCD Setup	53
4.9.4 MONO LCD Setup	58

Appendix A Pin Assignments - PCA-6654/6654L 63

A.1 CRT Display (CN1) 64
A.2 Flat Panel Display (CN2) 65
A.3 Flat Panel Display Header (JP1) 66
A.4 Keyboard Connector (J3) 67
A.5 Backlight Power Connector (J10) 67

**Appendix B Pin Assignments - FPM Receiver
(PanelLink) 69**

B.1 Flat Cable Panel Display Header (JP3) 70
B.2 Flat Cable Panel Display Extension Header (JP4) 71
B.3 Backlight Power (J3) 71
B.4 Extension Power (J6) 71
B.5 Flat Panel Display (J10) 72
B.6 FFC Connector (A) For Flat Panel Display (J11) 73
B.7 FFC Connector (B) For Flat Panel Display (J12) 74
B.8 Keyboard Connector (J17) 74

CHAPTER 1

Introduction

- Description
- Specifications
- Driver Support
- Utility Support
- Video BIOS
- Simultaneous Display Mode

1.1 Description

The PCA-6654/6654L is based on the CHIPS VGA flat panel/CRT controller and is fully IBM VGA compatible. This controller offers a large set of extended functions and higher resolutions, and it supports simultaneous functioning. Since the PCA-6654/6654L VGA card is fully compatible, you do not require any special drivers to operate in standard modes. The enclosed software drivers allow you to take advantage of the extended features of the PCA-6654/6654L:

- High performance in Microsoft Windows
- Resolutions up to 1024 x 768 in graphics modes with 64 K colors
- 640 x 480 resolution in graphics modes with 32K, 64K, and 16M colors
- 132 column text mode

Warning! *Be sure to turn off the power and unplug all components before attempting to install or adjust the PCA-6654/6654L. Make sure the jumpers are set correctly before connecting the PCA-6654/6654L to your flat panel display. Incorrect jumper settings could damage your display.*



1.2 Specifications

Chipset: CHIPS 65550, integrated flat panel/CRT VGA controller

Slot: High performance 32-bit PCI bus add-on card

BIOS: 27C512, multiple panel support (8 panels built in)

Memory: 2 MB EDO DRAM on board

256 K x 16 DRAM sockets for frame buffer (optional)

Windows GUI (Graphic User Interface) accelerator:

64-bit Graphics Engine

Simultaneous hardware cursor and pop-up window:

64 x 64 pixels by 4 colors

128 x 128 pixels by 2 colors

Simultaneous CRT/LCD display:

Available with TFT, DSTN, MONO and CRT

Display support:

Display centering and stretching features for optimal fit of VGA graphics and text on 800 x 600 and 1024 x 768 panels.

CRT -

Up to 1024 x 768 non-interlaced analog or multi-synch monitors with 64 K colors

Flat panel -

TFT LCD (Max resolution 1024 x 768, up to 64 K colors)

DSTN LCD (Max resolution 1024 x 768, up to 4096 colors)

MONO LCD (Up to 64 gray scales)

VESA standards supported (40 K BIOS only):

DPMS for CRT power-down (required for support of EPA Energy-Star Program)

DDC for CRT plug and display control

Connectors:

MDR-26 for flat panel display (PanelLink)

DB-15 for CRT

Built-in 44-pin header for Advantech standard flat panel pin assignment

Built-in housing to connect VR for adjusting contrast/brightness

Power:

On-board DC-DC converter supplies LCD bias voltage

LCD backlight power supplied

PanelLink:

High speed and low EMI operation

Flexible panel interface

1.3 Driver Support

The software driver provides for the following systems:

<u>Software</u>	<u>Name of VGA Driver Disk</u>
Microsoft Windows 95	PCA-6654 VGA Driver Windows 95 & NT 4.0
Microsoft Windows NT 4.0	PCA-6654 VGA Driver Windows 95 & NT 4.0
IBM OS/2	PCA-6654 VGA Driver OS/2

1.4 Utility Support

The utility provides:

CT.COM Enable CRT display only

FP.COM Enable panel display only

SM.COM Enable both displays at the same time

REVERSE.EXE Reverse the displays' colors

READBIOS.EXE Read the VGA BIOS information

TESTDDC.EXE Test if the VGA BIOS supports DDC

These utilities are only supported in DOS mode, and can only be used for testing.

1.5 Video BIOS

The standard BIOS chip supports eight kinds of flat panel displays:

1024 x 768 DSTN (Sharp LM14X82)

640 x 480 MONO (Sharp LM64P89)

640 x 480 DSTN (Kyocera KCB6448BSTT-X5)

800 x 600 DSTN

640 x 480 SHARP TFT

640 x 480 18-bit TFT (Toshiba LTM10C209A)

1024 x 768 TFT

800 x 600 TFT (Toshiba LTM10C273)

Note 1: To program the VGA BIOS to support the LCD only, you must use the file "6654-STN.DAT" located on the utility disk.

Note 2: The Chips 65550 chipset cannot support a 1024 x 768 DSTN LCD on SM mode, due to bandwidth problems.

1.6 Simultaneous Display Mode

The PCA-6654/6654L supports simultaneous display to a CRT monitor and a flat panel display. The flat panel may be TFT, DSTN or MONO.

If you use a DSTN LCD in this mode, the display must be under 16/256 colors or the CRT and flat panel screens will tremble. You must add a frame buffer with 512 K RAM and update the BIOS setup. Call us for assistance.

CHAPTER 2

Hardware Setup

- Hardware Configuration
- Jumpers and Connectors
- Jumpers, Connectors and Switches
- Connectors for Adjuster
- Board Layout - Jumpers, Connectors and Switches
- Jumper and Switch Settings
- LCD Setup
 - Preliminary
 - TFT LCD Setup
 - DSTN LCD Setup
 - MONO LCD Setup

2.1 Hardware Configuration

The PCA-6654/6654L is based on chipset 65550 and has high performance, a simple configuration, and fully supported LCD/CRT.

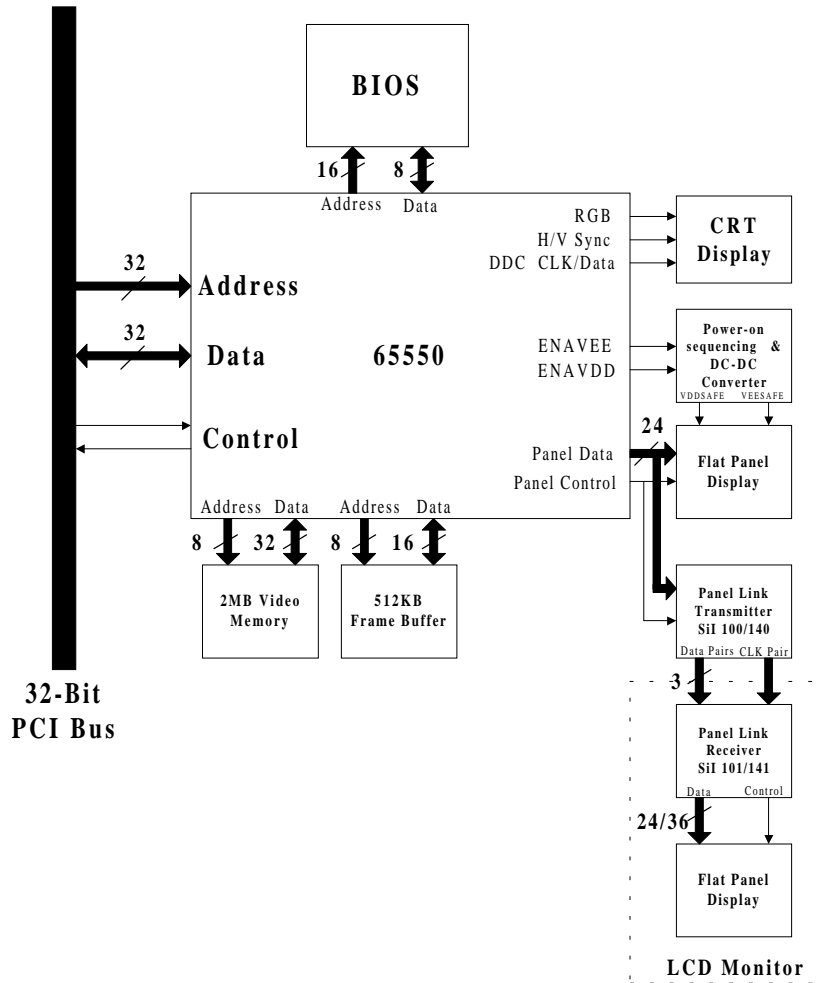
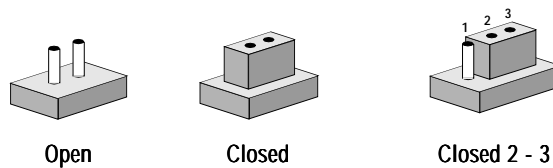

Figure 2-1: System block diagram

2.2 Jumpers and Connectors

Setting jumpers

You can configure your PCA-6654/6654L to match the needs of your application by setting jumpers. A jumper is the simplest kind of electrical switch. It consists of two metal pins and a small metal clip (often protected by a plastic cover) that slides over the pins to connect them. To “close” a jumper, you connect the pins with the clip. To “open” a jumper you remove the clip. Sometimes a jumper will have three pins, labeled 1, 2, and 3. In this case, you would connect either pins 1 and 2 or pins 2 and 3.



The jumper settings are schematically depicted in this manual as follows:

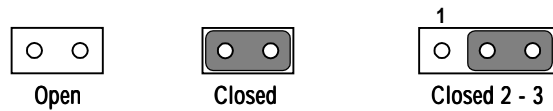

A pair of needle-nose pliers may be helpful when working with jumpers.

If you have any doubts about the best hardware configuration for your application, contact your local distributor or sales representative before you make any changes.

2.3 Jumpers, Connectors and Switches

Table 2-1: Jumpers, connectors, switches and their functions

Label	Function
CN1	CRT display
CN2	Flat panel display
JP1	Flat panel display header
J3	Keyboard connector
J10	Backlight power connector
J4	DSTN LCD contrast adjustment
J5	MONO LCD contrast adjustment
J9	LCD brightness adjustment
J6	LCD signal level select
J7	LCD bias voltage select (MONO)
J8	LCD bias voltage select
SW1	LCD type select
SW2	LCD clock configuration select (for PanelLink only)
SW3	LCD control signal configuration select (for PanelLink only)

Please refer to Appendix A for pin assignments.

2.4 Connectors for Adjuster

J4

This is a 3-pin housing. Connect a 500 Ω external VR to adjust V_{CON} ; voltage range 0 ~ +2.8 V.

J5

This is a 2-pin housing. Connect a 500 Ω external VR with on-board R-23 to adjust V_{EE} ; voltage range +5 ~ +40 V or 0 ~ -40 V, depending on the jumper setting.

J9

This is a 3-pin housing. Connect a 500 Ω external VR to adjust V_{BR} ; voltage range 0 ~ +4.3 V.

2.5 Board Layout - Jumpers, Connectors and Switches

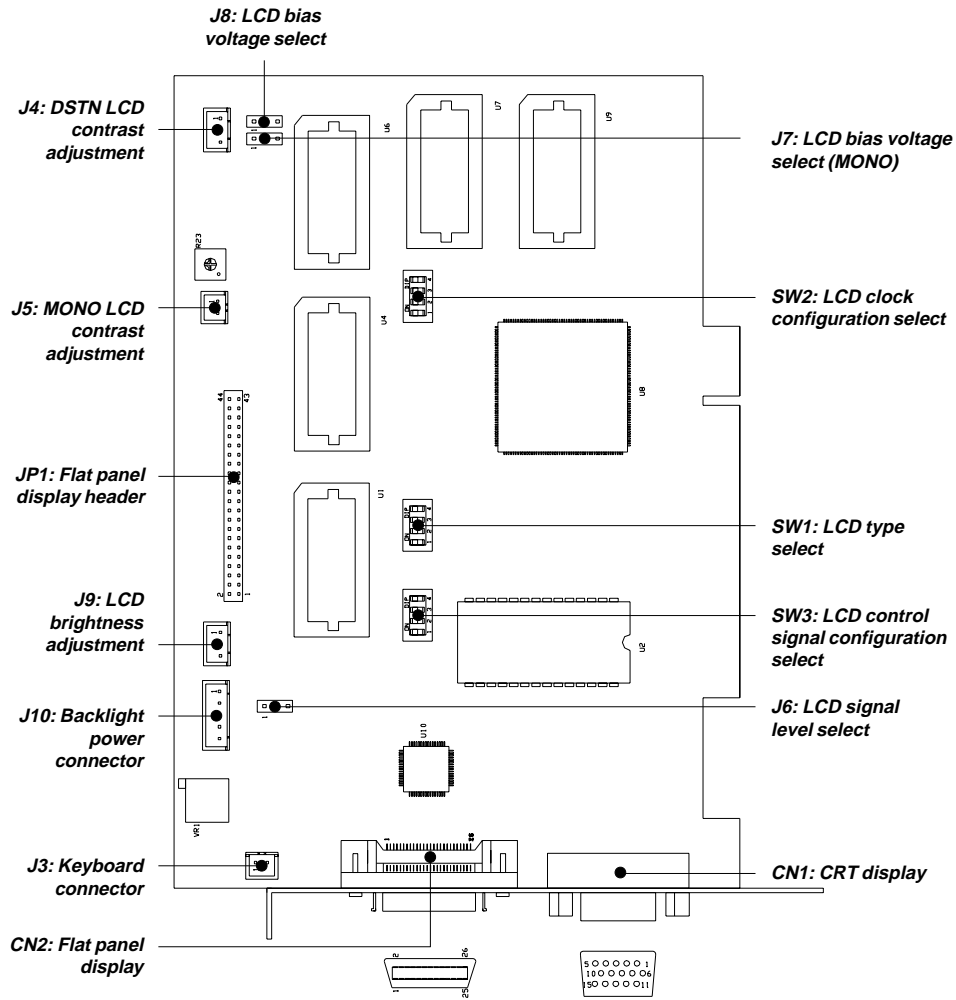

Figure 2-2: Board layout - jumpers, connectors and switches

2.6 Jumper and Switch Settings

Be sure the jumper and switch settings are correct before you install the card to the chassis. Refer to Fig. 2-2 for jumper and switch locations.

For information about installing an LCD into your system, refer to Section 2. (LCD Setup) or Chapter 4 (FPM Receiver Setup) of this manual.

2.6.1 LCD signal level select (J6)

Table 4-4: LCD signal level select (J6)

* 5 V

3.3 V

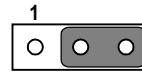
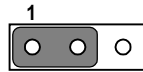

* default setting

2.6.2 LCD bias voltage select (MONO) (J7)

Table 4-5: LCD bias voltage select (MONO) (J7)

+V_{EE} [+5 V ~ +40 V]

* -V_{EE} [0 V ~ -40 V]

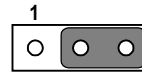

* default setting

2.6.3 LCD bias voltage select (J8)

Table 4-3: LCD bias voltage select (J8)

V_{EE} [+5 ~ +40 V or 0 ~ -40 V for MONO LCD]

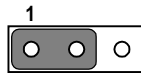

* V_{CON} [0 ~ +2.8 V for DSTN LCD]

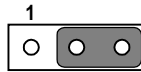

* default setting

2.6.4 LCD type select (SW1)

Table 2-5: LCD type select (SW1)

LCD type	Pin 1	Pin 2	Pin 3	Pin 4
* 640 x 480 18-bit TFT	OFF	ON	OFF	ON
640 x 480 SHARP TFT	ON	ON	OFF	ON
800 x 600 TFT	OFF	OFF	OFF	ON
1024 x 768 TFT	ON	OFF	OFF	ON
640 x 480 DSTN	ON	OFF	ON	ON
800 x 600 DSTN	OFF	OFF	ON	ON
1024 x 768 DSTN	ON	ON	ON	ON
640 x 480 MONO	OFF	ON	ON	ON

* default setting

2.6.5 LCD clock configuration select (for PanelLink only) (SW2)

Table 2-6: LCD clock configuration select (for PanelLink only) (SW2)

LCD type	Pin 1	Pin 2	Pin 3	Pin 4
* TFT	ON	OFF	ON	OFF
640 x 480 DSTN	OFF	ON	OFF	ON
800 x 600 DSTN	OFF	ON	OFF	ON
1024 x 768 DSTN	ON	OFF	OFF	ON
640 x 480 MONO	ON	OFF	ON	OFF

* default setting

2.6.6 LCD control signal configuration select (for PanelLink only) (SW3)

Table 2-7: LCD control signal configuration select (for PanelLink only) (SW3)

Pin number and setting details

1	* The LCD input data are latched on falling edge of clock → ON The LCD input data are latched on rising edge of clock → OFF
2	* The LCD control signals are latched on falling edge of clock → ON The LCD control signals are latched on rising edge of clock → OFF
3	The Si1100 differential clock output is divided by two → ON * The Si1100 differential clock output is divided by one → OFF

* default setting

2.7 LCD Setup

2.7.1 Preliminary

Make sure that your LCD is ready to match your PCA-6654/6654L card prior to setting jumpers and switches. You will need to know your LCD specifications, which will be among the following:

1. LCD type: TFT, DSTN or MONO
2. Number of pixels:
640 x 480, 800 x 600 or 1024 x 768 respectively
3. Supply voltage: 5 V or 3.3 V
4. LCD bias voltage for DSTN or MONO: $V_{min.}$, $V_{typ.}$, $V_{max.}$
5. Backlight brightness voltage range in inverter

You must also have the following parts ready:

1. LCD cable, to connect the LCD to JP1
2. Inverter, which must match your LCD specifications
3. Inverter power wire, to connect the inverter to J10
4. 500 Ω VR assembly with wire, for adjusting brightness
5. 500 Ω VR assembly with wire, for adjusting contrast (DSTN or MONO LCD only)

Note: If your DSTN LCD does not have a built-in DC/DC converter, you must set up your LCD according to the MONO LCD setup procedures, except for when you set up SW1.

2.7.2 TFT LCD Setup

Follow these steps:

1. Set SW1 according to the following table:

Table 2-8: TFT LCD setup (SW1)

LCD type	Pin 1	Pin 2	Pin 3	Pin 4
* 640 x 480 18-bit TFT	OFF	ON	OFF	ON
640 x 480 SHARP TFT	ON	ON	OFF	ON
800 x 600 TFT	OFF	OFF	OFF	ON
1024 x 768 TFT	ON	OFF	OFF	ON

* default setting

2. Set SW2 as follows, for all TFT LCDs:

LCD type	Pin 1	Pin 2	Pin 3	Pin 4
All TFT types	ON	OFF	ON	OFF

3. You do not need to set SW3.
4. Set J6 according to your LCD input power specifications:

Table 2-9: LCD signal level select (J6)



* default setting

5. You do not need to set J7 or J8.
6. Connect the LCD cable, inverter, inverter power wire, and VR assembly with wire to J9. (See Fig. 2-3.)
7. Plug the VGA card into the PCI slot.
8. Power on the system.
9. Adjust the screen brightness using the VR control.

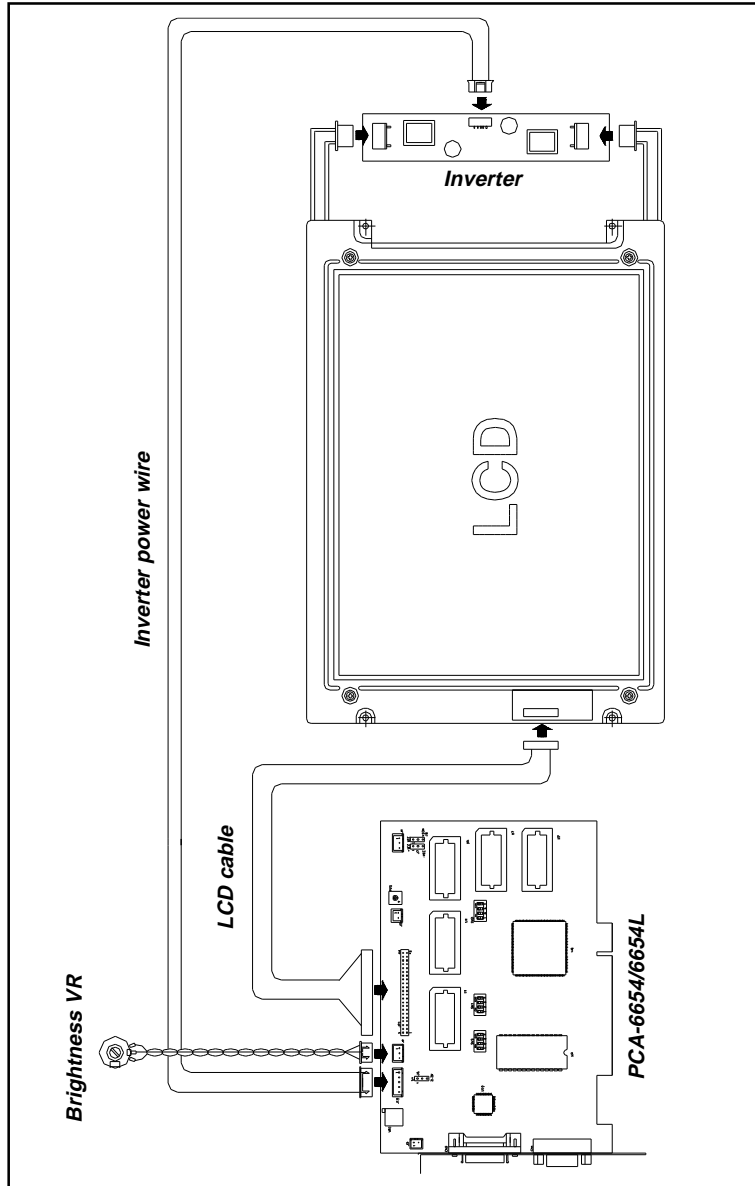

Figure 2-3: TFT LCD setup

2.7.3 DSTN LCD Setup

Follow these steps:

1. Set SW1 according to the following table:

Table 2-10: DSTN LCD setup (SW1)

LCD type	Pin 1	Pin 2	Pin 3	Pin 4
640 x 480 DSTN	ON	OFF	ON	ON
800 x 600 DSTN	OFF	OFF	ON	ON
1024 x 768 DSTN	ON	ON	ON	ON

2. Set SW2 as follows, for all DSTN LCDs:

LCD type	Pin 1	Pin 2	Pin 3	Pin 4
All DSTN types	ON	OFF	ON	OFF

3. You do not need to set SW3.
4. Set J6 according to your LCD input power specifications:

Table 2-11: LCD signal level select (J6)

* 5 V		3.3 V	
1		1	
2		2	
3		3	

* default setting

5. You do not need to set J7.

6. Set J8 as follows:

Table 2-12: LCD bias voltage select (J8)

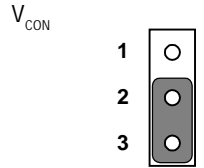

7. Connect the LCD cable, inverter, inverter power wire, and VR assembly. The VR assembly with wire for brightness control should be connected to J9, and the wire for contrast control should be connected to J4. (See Fig. 2-4.)
8. Plug the VGA card into the PCI slot.
9. Power on the system.
10. Adjust the screen brightness and contrast using the VR controls.

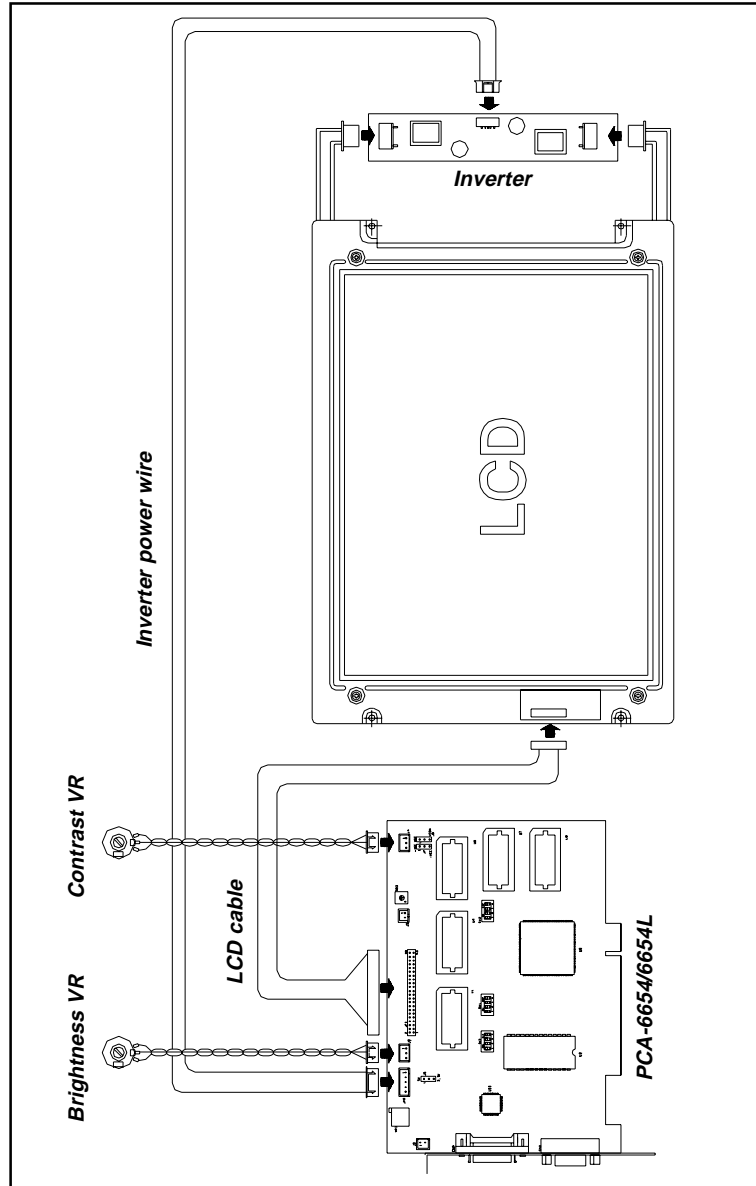

Figure 2-4: DSTN LCD setup

2.7.4 MONO LCD Setup

Follow these steps:

1. Set SW1 as follows:

LCD type	Pin 1	Pin 2	Pin 3	Pin 4
640 x 480 MONO	OFF	ON	ON	ON

2. Set SW2 as follows:

LCD type	Pin 1	Pin 2	Pin 3	Pin 4
640 x 480 MONO	ON	OFF	ON	OFF

3. You do not need to set SW3.

4. Set J6 according to your LCD input power specifications:

Table 2-13: LCD signal level select (J6)



* default setting

5. Set J7 as follows:

Table 2-14: LCD bias voltage select (MONO) (J7)

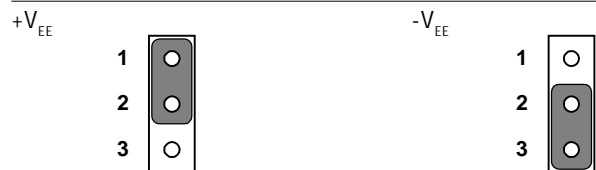

6. Set J8 as follows:

Table 2-15: LCD bias voltage select (J8)

V_{EE}

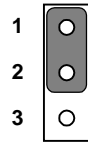

-
7. Plug the VGA card into the PCI slot.
 8. Short J5.
 9. Power on the system.
 10. Adjust R-23 to be V_{EE} max.
 11. Power off the system.
 12. Remove the jumper on J5.
 13. Connect the LCD cable, inverter, inverter power wire, and VR assembly. The VR assembly with wire for brightness control should be connected to J9, and the wire for contrast control should be connected to J5. (See Fig. 2-5.)
 14. Power on the system.
 15. Adjust the screen brightness and contrast using the VR controls.

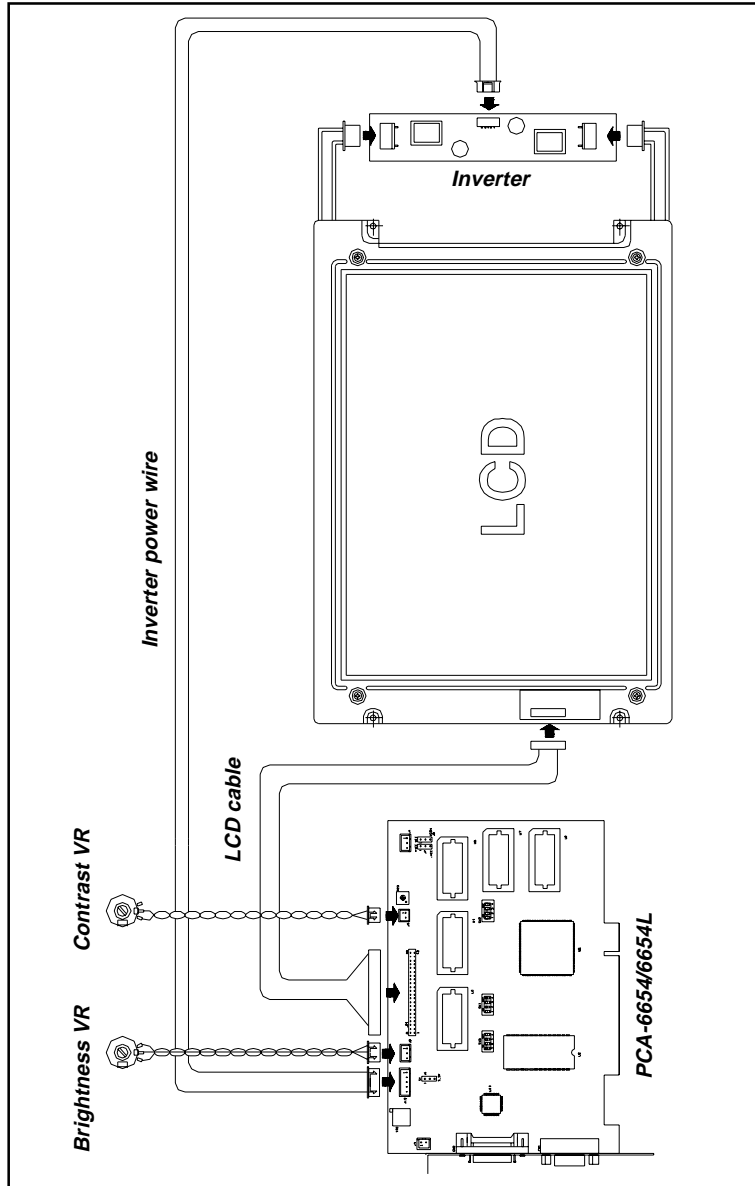

Figure 2-5: MONO LCD setup

CHAPTER 3

Software Installation

This chapter describes the installation and operation of the software drivers on the display driver diskettes included in your PCA-6654/6654L package. Sections in this chapter include:

- Simultaneous Display Mode
- Installation for Windows 95
- Installation for Windows NT
- Installation for OS/2
- Further Information

3.1 Simultaneous Display Mode

The 65550 VGA BIOS supports color TFT, color DSTN and monochrome LCD flat panel displays. It also supports interlaced and non-interlaced analog monitors (VGA color and VGA monochrome) in high-resolution modes while maintaining complete IBM VGA compatibility. Digital monitors (i.e. MDA, CGA, and EGA) are NOT supported. Multiple frequency (multisync) monitors are supported as analog monitors.

Both CRT and panel displays can be used simultaneously. The PCA-6654/6654L can be set in one of three configurations: on a CRT, on a flat panel display, or on both simultaneously. The system is initially set to simultaneous display mode. In the utility diskettes, there are three .COM files which can be used to select the display. Simply type the file name at the DOS prompt:

CT.COM Enables CRT display only

FP.COM Enables panel display only

SM.COM Enables both displays at the same time

3.2 Installation for Windows 95

1.
 - a. Select "Start" , "Settings" , "Control Panel".
 - b. Double click the "display" icon.
 - c. Choose the "Settings " label.
 - d. Press the "Advanced Properties" button.

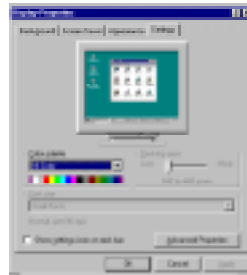

2.
 - a. Choose the "Adapter" label.
 - b. Press the "Change..." button.

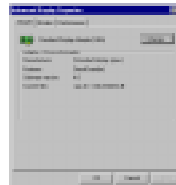

3.
 - a. Press the "Have Disk..." button.

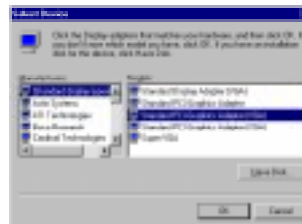

4.
 - a. Insert the "VGA Driver Windows 95&NT 4.0" disk into the floppy driver.
 - b. Type "A: \WIN95P.244".
 - c. Press the "OK" button.

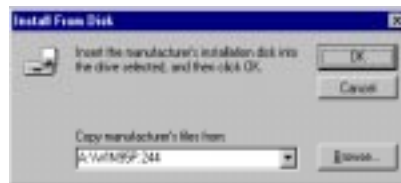

5. a. Press the "OK" button.

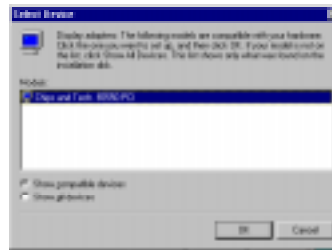

6. a. "Chips and Tech 65550PCI" appear in the Adapter label.
b. Press the "Close" button.

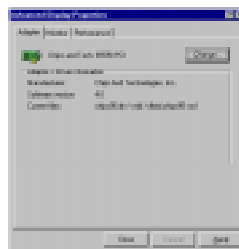

7. a. Press the "Yes" button
b. Close all windows to reboot

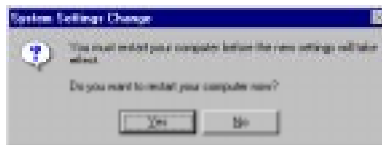

8. a. Repeat Step 1 on the previous page of this manual.
b. The "Chips" label appears in "Display Properties".
c. Adjust the resolution and color.

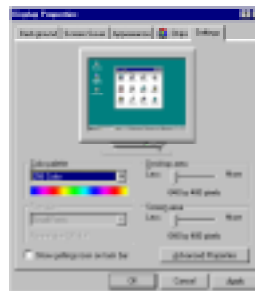

9. a. Choose the "Chips" label.
b. Adjust the refresh rate and display device.
c. Press the "OK" button

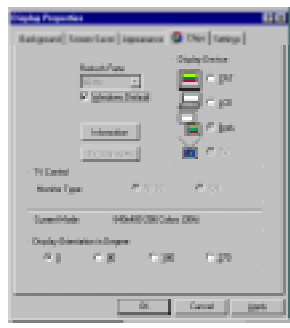

10. a. Press the "OK" button to change the display setting.

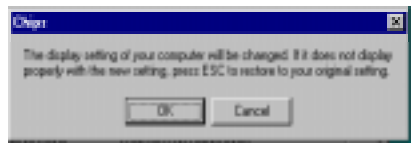

11. a. Press the "OK" button to confirm the setting.

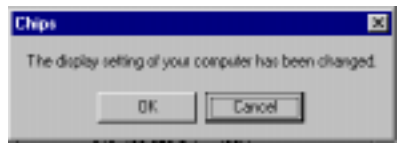

END

3.3 Installation for Windows NT

1.
 - a. Select "Start", "Settings", "Control Panel".
 - b. Double click the "display" icon.
 - c. Choose the "Settings" label.
 - d. Press the "Display Type" button.

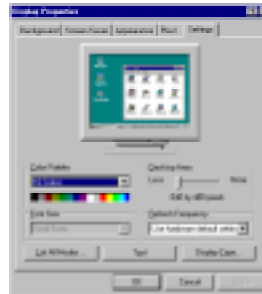

2.
 - a. Press the "Change..." button.

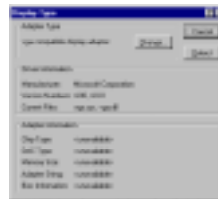

3.
 - a. Press the "Have Disk..." button.

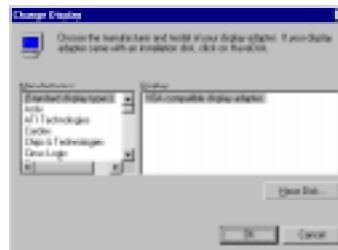

4.
 - a. Insert the "VGA Driver Windows 95&NT 4.0" disk into the floppy driver.
 - b. Type "A:\WINNT4.115".
 - c. Press the "OK" button.



5. a. Press the "OK" button.

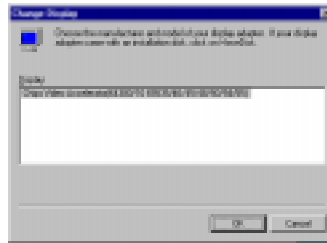

6. a. Press the "Yes" button

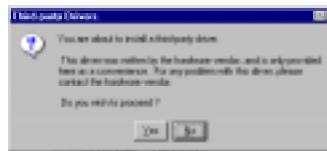

7. a. Press the "OK" button
b. Close all windows to reboot

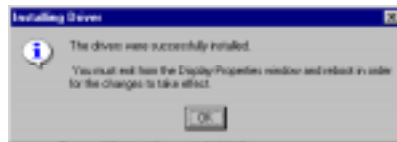

8. a. Repeat Step 1 on the previous page of this manual.
b. The "Chips" label appears in "Display Properties".
c. Adjust the resolution, color and refresh rate.
d. Press the "Test" button to check the setting.
e. Press the "OK" button to confirm the setting.



END

3.4 Installation for OS/2

1.
 - a. Select "OS/2 System", "Command Prompts", "OS/2 Window".
 - b. Insert the "VGA Driver OS/2" disk into the floppy driver.
 - c. Type "A:", <Enter>.
 - d. Type "setup A: C:", <Enter>.

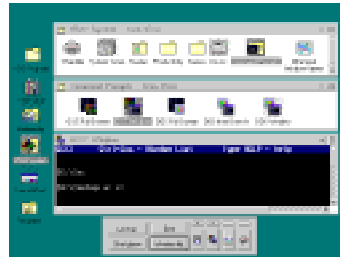

2.
 - a. Press the "OK" button to shut down.
 - b. Reboot again.

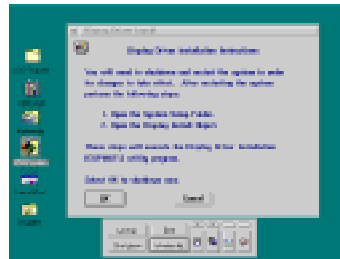

3.
 - a. Select "OS/2 System", "System Setup", "Display Driver Install".
 - b. Enable "Primary Display".
 - c. Press the "OK" button.

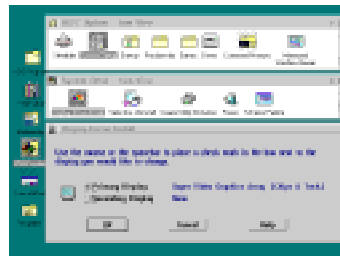

4.
 - a. Select "Chips & Technologies 65550/554/555".
 - b. Press the "OK" button.

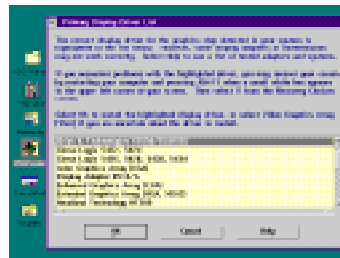

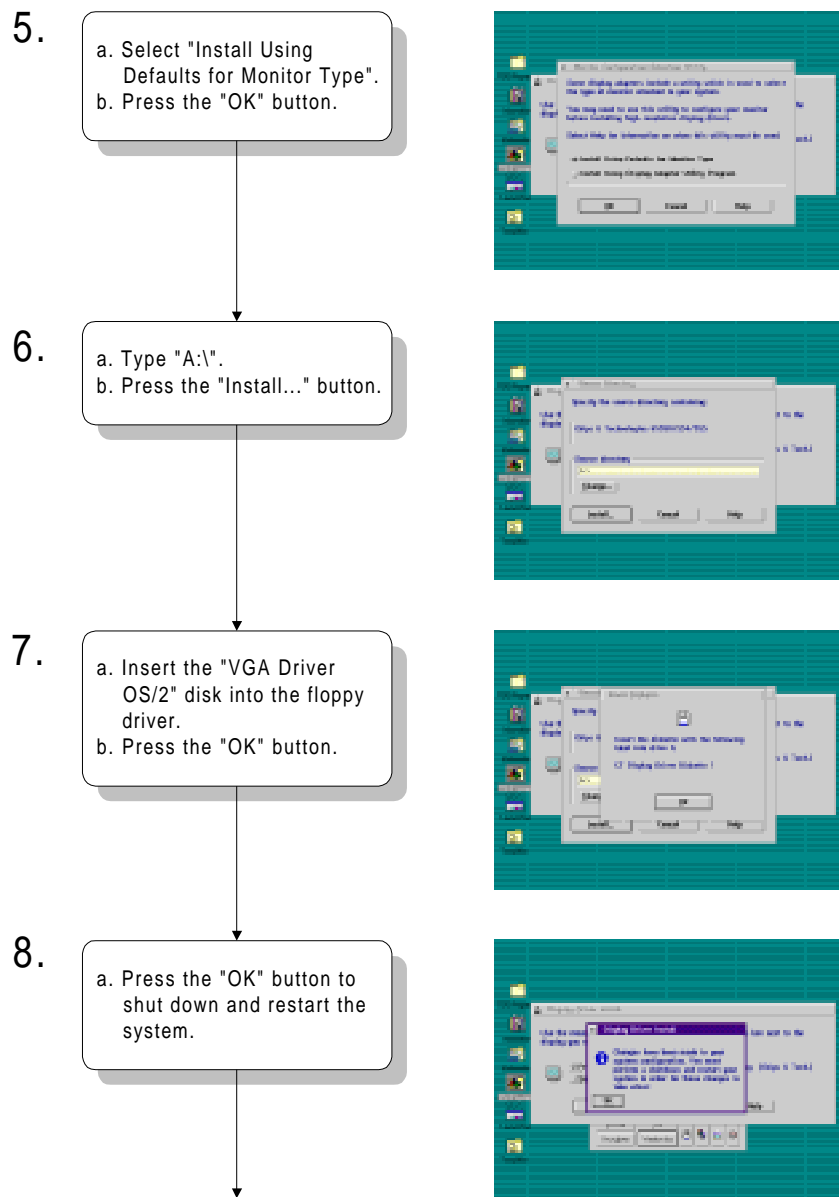

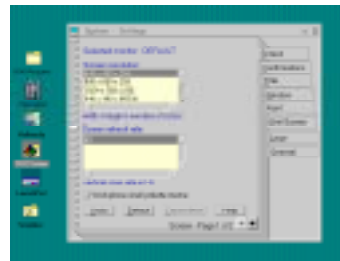
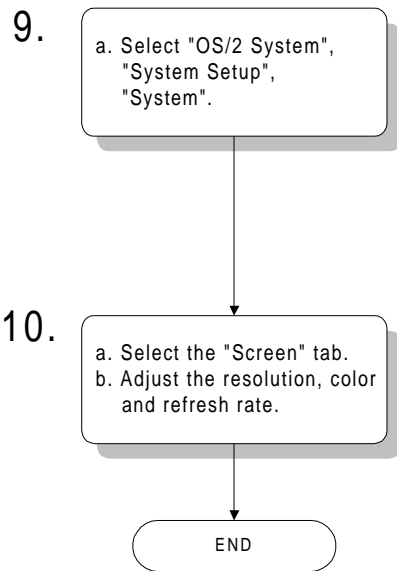

3.5 Further Information

For further information about installation of the PCI/SVGA in your PCA-6654/6654L, including driver updates, troubleshooting guides and FAQ lists, visit the following web resources:

C&T web site: www.chips.com

Advantech web sites: www.advantech.com

www.advantech.com.tw

CHAPTER 4

FPM Receiver Setup (PanelLink) (for PCA-6654 only)

- Introduction
- Jumpers and Connectors
- Connectors
- Connectors for Adjuster
- Board Layout - Connectors
- Jumpers and Switches
- Board Layout - Jumpers and Switches
- Jumper and Switch Settings
- LCD Setup
 - Preliminary
 - TFT LCD Setup
 - DSTN LCD Setup
 - MONO LCD Setup

4.1 Introduction

The SiI100/140 (added into the PCA-6654) and SiI101/141 (added into the FPM-40 receiver) are high-speed digital video/graphics interconnection devices capable of supporting VGA to XVGA resolutions for TFT panels and VGA to XGA resolutions for DSTN LCD panels. These devices are based on Silicon Image's Panellink technology that currently enables reliable, scalable, high-speed data transmission over the same interface, from VGA to SVGA resolutions (and up to HDTV resolution in the future). The Panellink transmitter incorporates an advanced coding scheme to enable TMDS signals to reduce EMI across copper cables and DC-balancing for data transmission over fiber optics. In addition, the advanced coding scheme enables robust clock recovery at the receiver to achieve high-skew tolerance for driving longer cable lengths. To maximize data recovery accuracy, the receiver triple oversamples and makes use of a data recovery algorithm to select the most reliable data sampling points.

4.2 Jumpers and Connectors

Setting jumpers

You can configure your FPM card to match the needs of your application by setting jumpers. A jumper is the simplest kind of electrical switch. It consists of two metal pins and a small metal clip (often protected by a plastic cover) that slides over the pins to connect them. To “close” a jumper, you connect the pins with the clip. To “open” a jumper you remove the clip. Sometimes a jumper will have three pins, labeled 1, 2, and 3. In this case, you would connect either pins 1 and 2 or pins 2 and 3.

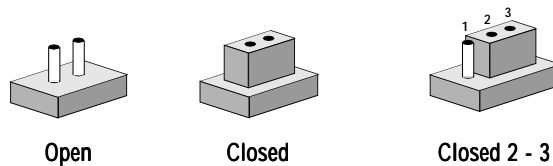

The jumper settings are schematically depicted in this manual as follows:

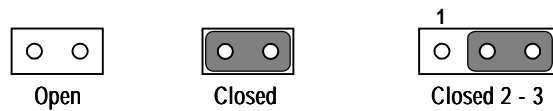

A pair of needle-nose pliers may be helpful when working with jumpers.

If you have any doubts about the best hardware configuration for your application, contact your local distributor or sales representative before you make any changes.

4.3 Connectors

Table 4-1: Connectors

Label	Function
JP3	Flat cable panel display header
JP4	Flat cable panel display extension header
J3	Backlight power
J6	Extension power
J10	Flat panel display connector
J11	FFC connector (A) for flat panel display
J12	FFC connector (B) for flat panel display
J17	Keyboard connector
J1	MONO LCD contrast adjustment
J2	Brightness adjustment
J7	DSTN LCD contrast adjustment

Please refer to Appendix B for pin assignments.

4.4 Connectors for Adjuster

J1

This is a 2-pin housing. Connect a 500 Ω external VR with on-board VR1 to adjust $V_{EE\text{SAFE}}$; voltage range +5 ~ +40 V and 0 ~ -40 V.

J2

This is a 3-pin housing. Connect a 500 Ω external VR to adjust V_{BR} ; voltage range 0 ~ +4.3 V.

J7

This is a 3-pin housing. Connect a 500 Ω external VR to adjust $V_{EE\text{SAFE}}$; voltage range 0 ~ +2.8 V.

4.5 Board Layout - Connectors

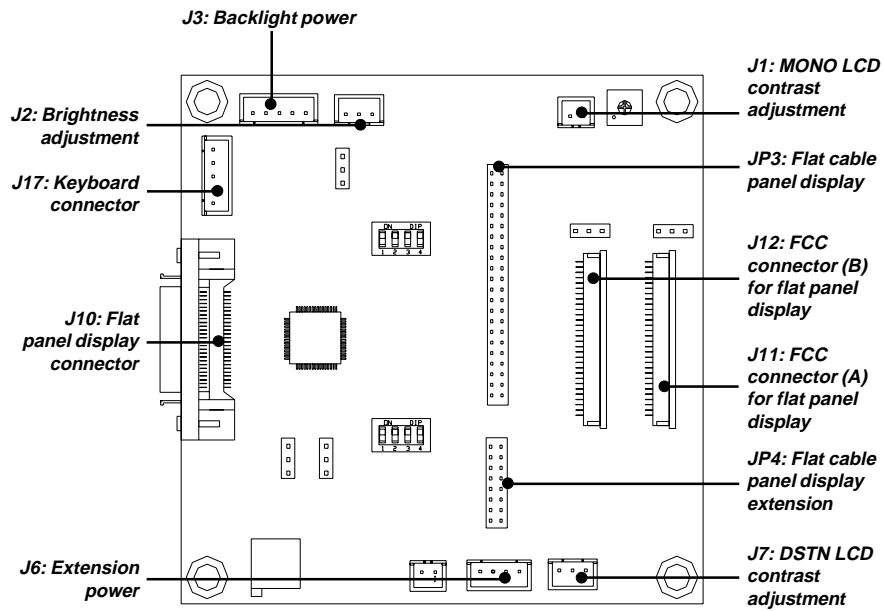

Figure 4-1: Board layout - connectors

4.6 Jumpers and Switches

Table 4-2: Jumpers and switches

Label	Function
J5	LCD bias voltage select
J8	LCD signal level select
J13	LCD bias voltage select (MONO)
J14	LCD input clock select
J15	Backlight level select
J16	Power down select
S1	LCD type select
S2	LCD clock configuration select

4.7 Board Layout - Jumpers and Switches

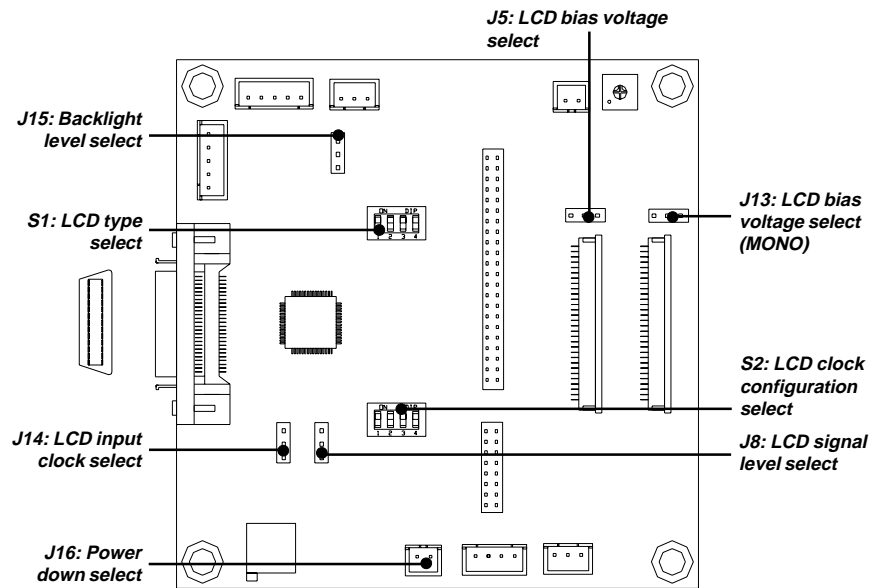

Figure 4-3: Board layout - jumpers and switches

4.8 Jumper and Switch Settings

Make sure the jumper and switch settings are correct before you install the FPM card to the chassis. Please refer to Appendix B for pin assignments.

4.8.1 LCD bias voltage select (J5)

Table 4-3: LCD bias voltage select (J5)

V_{EE} [+5 ~ +40 V or 0 ~ -40 V for MONO LCD]

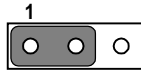

* V_{CON} [0 ~ +2.8 V for DSTN LCD]

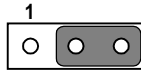

* default setting

4.8.2 LCD signal level select (J8)

Table 4-4: LCD signal level select (J8)

* 5 V

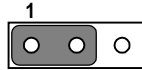

3.3 V

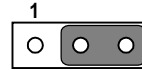

* default setting

4.8.3 LCD bias voltage select (MONO) (J13)

Table 4-5: LCD bias voltage select (MONO) (J13)

$+V_{EE}$ [+5 V ~ +40 V]

* $-V_{EE}$ [0 V ~ -40 V]

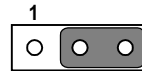
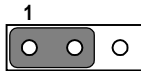

* default setting

4.8.4 LCD input clock select (J14)

Table 4-6: LCD input clock select (J14)

* Divided by one

Divided by two

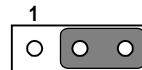
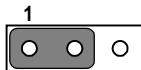

* default setting

4.8.5 Backlight level select (J15)

Table 4-7: Backlight level select (J15)

* $ENAV_{EE}$ [high level]

$/ENAV_{EE}$ [low level]



* default setting

4.8.6 Power down select (J16)

Table 4-8: Power down select (J16)

Power down * Normal



* default setting

4.8.7 LCD type select (S1)

Table 4-9: LCD type select (S1)

LCD type	Pin 1	Pin 2	Pin 3	Pin 4
* 640 x 480 DSTN	ON	OFF	OFF	OFF
800 x 600 DSTN	ON	OFF	OFF	OFF
1024 x 768 DSTN	OFF	ON	OFF	OFF
TFT	OFF	OFF	ON	OFF

* default setting

4.8.8 LCD clock configuration select (S2)

Table 4-10: LCD clock configuration select (S2)

LCD type	Frequency/data latch edge/mode	Pin	Pin	Pin	Pin
		1	2#	3	4
* TFT/16-bit DSTN	divided by 1/negative/free running	ON	X	ON	ON
TFT/16-bit DSTN	divided by 1/positive/free running	ON	X	OFF	ON
TFT	divided by 2/negative/free running	OFF	X	ON	ON
TFT	divided by 2/positive/free running	OFF	X	OFF	ON
24-bit DSTN	divided by 1/negative/blanked low	ON	X	ON	OFF
NONE	divided by 1/negative/blanked high	ON	X	OFF	OFF
24-bit DSTN	divided by 2/negative/blanked low	OFF	X	ON	OFF
24-bit DSTN	divided by 4/negative/blanked low	OFF	X	OFF	OFF

* default setting

Termination resistor range selection:

ON: 55 ~ 70 Ω

OFF: 40 ~ 57 Ω (default)

4.9 LCD Setup

4.9.1 Preliminary

Before you set the jumpers and switches, you need to know the LCD specifications, which will be among the following:

1. LCD type: TFT, DSTN or MONO
2. Number of pixels: 640 x 480, 800 x 600 or 1024 x 768 respectively
3. One pixel per clock or two pixels per clock in TFT LCD
4. LCD input data and control signals are latched on falling or rising edge
5. Supply voltage: 5 V or 3.3 V
6. LCD bias voltage for DSTN or MONO LCD: $V_{min.}$, $V_{typ.}$, $V_{max.}$
7. Backlight brightness voltage range in inverter.

You should also have:

1. PanelLink cable (refer to J10 and PCA-6654 CN2)
2. LCD cable (refer to LCD, JP3/JP4 or J11/J12 pin assignments)
3. Inverter (refer to LCD specifications)
4. Inverter power wire (refer to inverter and J3)
5. VR 500 Ω assembly with wire for adjusting brightness
6. VR 500 Ω assembly with wire for adjusting contrast (for DSTN or MONO LCD)

Note: *If your DSTN LCD does not have a built-in DC/DC converter, you must set up your LCD according to the MONO LCD setup procedures, except for when you set up SW1.*

4.9.2 TFT LCD Setup

Follow these steps:

PCA-6654

1. Set SW1 according to the following table:

Table 4-11: TFT LCD setup (SW1)

LCD type	Pin 1	Pin 2	Pin 3	Pin 4
640 x 480 18-bit TFT	OFF	ON	OFF	ON
640 x 480 SHARP TFT	ON	ON	OFF	ON
800 x 600 TFT	OFF	OFF	OFF	ON
1024 x 768 TFT	ON	OFF	OFF	ON

2. Set SW2 as follows, for all TFT LCDs:

LCD type	Pin 1	Pin 2	Pin 3	Pin 4
All TFT types	ON	OFF	ON	OFF

3. Set SW3 according to the following table:

Table 4-12: LCD control configuration select (SW3)

		ON	OFF
1	DATA EDGE	Falling edge	Rising edge
2	CLOCK EDGE	Falling edge	Rising edge
3	HALF CLOCK	Divided by two	Divided by one

4. You do not need to set J6, J7 and J8.

FPM Receiver

5. Set S1 as follows, for all TFT LCDs:

LCD type	Pin 1	Pin 2	Pin 3	Pin 4
All TFT types	OFF	OFF	ON	OFF

6. Set S2 according to the following table:

Table 4-13: LCD clock configuration select (S2)

Frequency/data latch edge/mode	Pin 1	Pin 2#	Pin 3	Pin 4
divided by 1/negative/free running	ON	X	ON	ON
divided by 1/positive/free running	ON	X	OFF	ON
divided by 2/negative/free running	OFF	X	ON	ON
divided by 2/positive/free running	OFF	X	OFF	ON

Termination resistor range selection:

ON: 55 ~ 70 Ω

OFF: 40 ~ 57 Ω (default)

7. You do not need to set J5.

8. Set J8 as follows:

Table 4-14: LCD signal level select (J8)

* 5 V

3.3 V

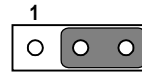
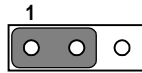

* default setting

9. You do not need to set J13.

10. Set J14 as follows:

Table 4-15: LCD input clock select (J14)

* Divided by one

Divided by two

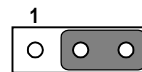

* default setting

11. Set J15 as follows:

Table 4-16: Backlight level select (J15)

* ENAV_{EE} [high level]

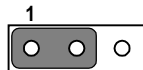

/ENAV_{EE} [low level]

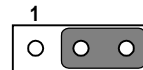

* default setting

12. Set J16 as follows:

Table 4-17: Power down select (J16)

Normal



-
13. Connect the PanelLink cable, LCD cable, inverter, inverter power wire, and VR assembly with wire to J2. (See Fig. 4-4.)
 14. Plug the VGA card into the PCI slot.
 15. Power on the system.
 16. Adjust the screen brightness using the VR control.

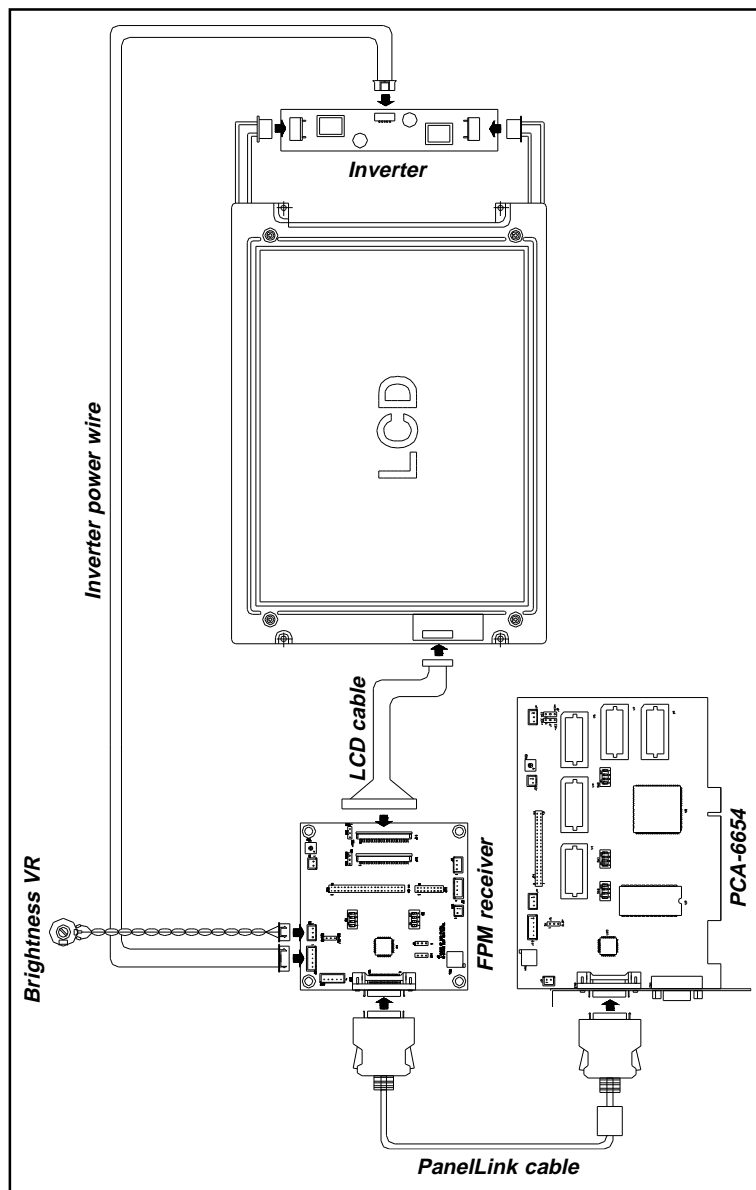

Figure 4-4: TFT LCD setup

4.9.3 DSTN LCD Setup

PCA-6654

1. Set SW1 according to the following table:

Table 4-18: TFT LCD setup (SW1)

LCD type	Pin 1	Pin 2	Pin 3	Pin 4
640 x 480 DSTN	ON	OFF	ON	ON
800 x 600 DSTN	OFF	OFF	ON	ON
1024 x 768 DSTN	ON	ON	ON	ON

2. Set SW2 according to the following table:

Table 4-19: LCD clock configuration select (SW2)

LCD type	Pin 1	Pin 2	Pin 3	Pin 4
640 x 480 DSTN	OFF	ON	OFF	ON
800 x 600 DSTN	OFF	ON	OFF	ON
1024 x 768 DSTN	ON	OFF	OFF	ON

3. Set SW3 according to the following table:

Table 4-20: LCD control signal configuration select (SW3)

		ON	OFF
1	DATA EDGE	Falling edge	Rising edge
2	CLOCK EDGE	Falling edge	Rising edge
3	HALF CLOCK	Divided by two	Divided by one

4. You do not need to set J6, J7 or J8.

FPM Receiver

5. Set S1 according to the following table:

Table 4-21: LCD type select (S1)

LCD type	Pin 1	Pin 2	Pin 3	Pin 4
640 x 480 DSTN	ON	OFF	OFF	OFF
800 x 600 DSTN	ON	OFF	OFF	OFF
1024 x 768 DSTN	OFF	ON	OFF	OFF

6. Set S2 according to the following table:

Table 4-22: LCD clock configuration select (S2)

LCD type	Frequency/data latch edge/mode	Pin	Pin	Pin	Pin
		1	2#	3	4
16-bit DSTN	divided by 1/negative/free running	ON	X	ON	ON
16-bit DSTN	divided by 1/positive/free running	ON	X	OFF	ON
24-bit DSTN	divided by 1/negative/blanked low	ON	X	ON	OFF
24-bit DSTN	divided by 2/negative/blanked low	OFF	X	ON	OFF
24-bit DSTN	divided by 4/negative/blanked low	OFF	X	OFF	OFF

Termination resistor range selection:

ON: 55 ~ 70 Ω

OFF: 40 ~ 57 Ω

7. Set J5 as follows:

Table 4-23: LCD bias voltage select (J5)

V_{CON}



8. Set J8 as follows:

Table 4-24: LCD signal level select (J8)

* 5 V

3.3 V

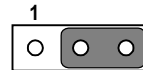

* default setting

9. You do not need to set J13.

10. Set J14 as follows:

Table 4-25: LCD input clock select (J14)

* Divided by one

Divided by two

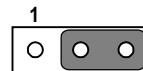

* default setting

11. Set J15 as follows:

Table 4-26: Backlight level select (J15)

* ENAV_{EE} [high level]

/ENAV_{EE} [low level]

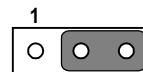

* default setting

12. Set J16 as follows:

Table 4-27: Power down select (J16)

Normal



13. Connect the PanelLink cable, LCD cable, inverter, inverter power wire, and VR assembly with wire for brightness to J2 and for contrast to J7. (See Fig. 4-5.)
14. Plug the VGA card into the PCI slot.
15. Power on the system.
16. Adjust the screen brightness and contrast using the VR controls.

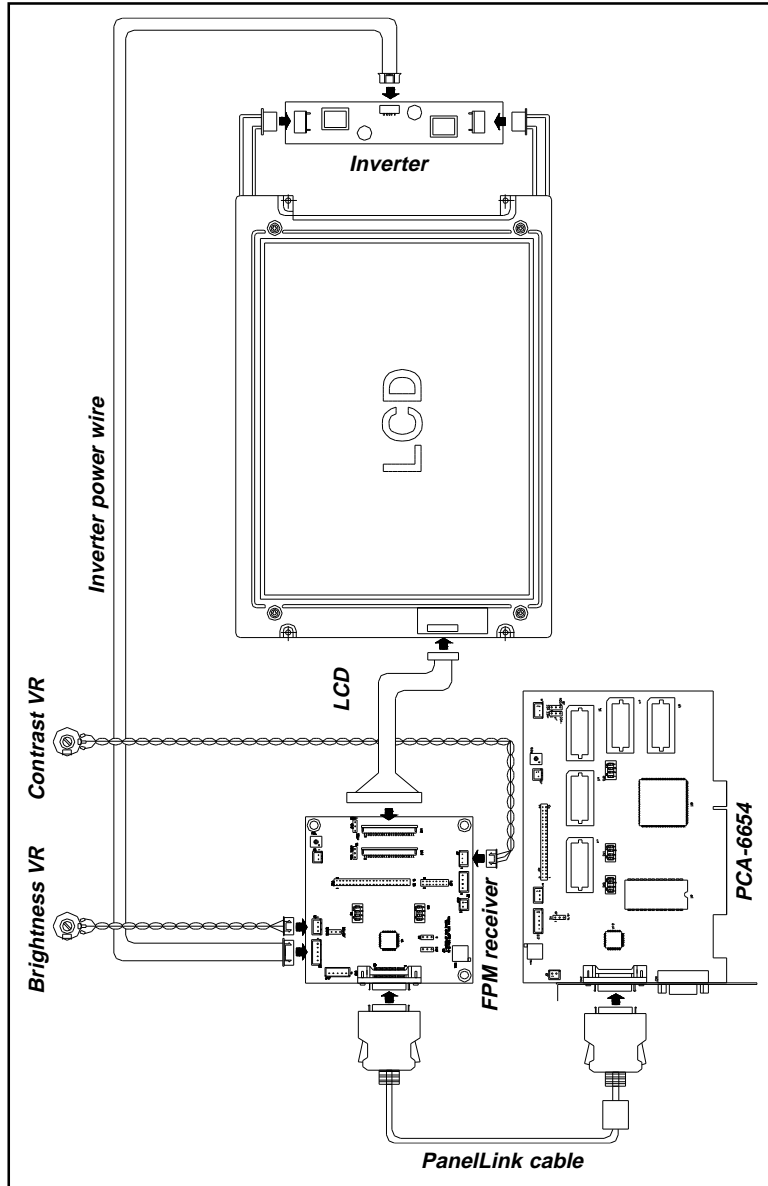

Figure 4-5: DSTN LCD setup

4.9.4 MONO LCD Setup

PCA-6654

1. Set SW1 as follows:

LCD type	Pin 1	Pin 2	Pin 3	Pin 4
640 x 480 MONO	OFF	ON	ON	ON

2. Set SW2 as follows:

LCD type	Pin 1	Pin 2	Pin 3	Pin 4
640 x 480 MONO	OFF	ON	OFF	ON

3. Set SW3 according to the following table:

Table 4-28: LCD control signal configuration select (SW3)			
		ON	OFF
1	DATA EDGE	Falling edge	Rising edge
2	CLOCK EDGE	Falling edge	Rising edge
3	HALF CLOCK	Divided by two	Divided by one

4. You do not need to set J6, J7 or J8.

FPM Receiver

5. Set S1 as follows:

Table 4-29: LCD type select (S1)				
LCD type	Pin 1	Pin 2	Pin 3	Pin 4
MONO	ON	OFF	OFF	OFF

6. Set S2 according to the following table:

Table 4-30: LCD clock configuration select (S2)

Frequency/data latch edge/mode	Pin 1	Pin 2#	Pin 3	Pin 4
divided by 1/negative/free running	ON	X	ON	ON
divided by 1/positive/free running	ON	X	OFF	ON

Termination resistor range selection:

ON: 55 ~ 70 Ω

OFF: 40 ~ 57 Ω

7. Set J5 as follows:

Table 4-31: LCD bias voltage select (J5)

V_{EE}



8. Set J8 as follows:

Table 4-32: LCD signal level select (J8)

* 5 V

3.3 V

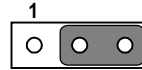
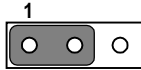

* default setting

9. Set J13 as follows:

Table 4-33: LCD bias voltage setting (J13)

$+V_{EE}$

* $-V_{EE}$

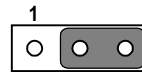

* default setting

10. Set J14 as follows:

Table 4-34: LCD input clock select (J14)

* Divided by one

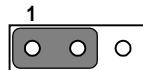

Divided by two

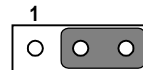

* default setting

11. Set J15 as follows:

Table 4-35: Backlight level select (J15)

* ENAV_{EE} [high level]



/ENAV_{EE} [low level]

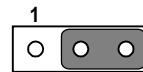

* default setting

12. Set J16 as follows:

Table 4-36: Power down select (J16)

Normal



13. Connect the PanelLink cable to the VGA card and the FPM-40 receiver. (See Fig. 4-6.)

14. Plug the VGA card into the PCI slot.

15. Short J1.

16. Power on the system.

17. Adjust VR1 to be V_{EE} max.

18. Power off the system.

19. Remove the jumper on J1.

20. Connect the LCD cable, inverter, inverter power wire, and VR assembly with wire for brightness to J2 and for contrast to J1. (See Fig. 4-6.)
21. Power on the system.
22. Adjust the screen brightness and contrast using the VR controls.

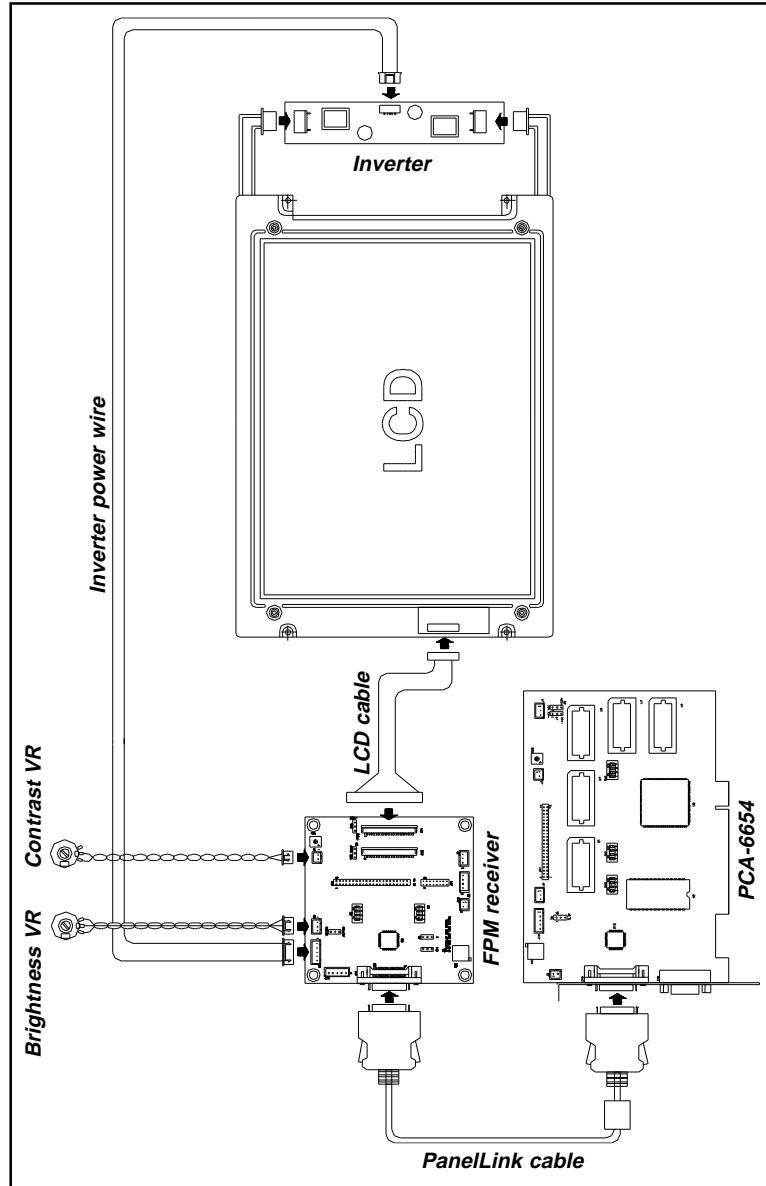

Figure 4-6: MONO LCD setup

APPENDIX A

Pin Assignments - PCA-6654/6654L

- CRT Display (CN1)
- Flat Panel Display (CN2)
- Flat Panel Display Header (JP1)
- Keyboard Connector (J3)
- Backlight Power Connector (J10)

A.1 CRT Display (CN1)

Table A-1: CRT display (CN1):

Pin	Signal	Pin	Signal
1	R	9	+5 V
2	G	10	GND
3	B	11	NC
4	NC	12	DDC Data
5	GND	13	Horizontal sync
6	GND	14	Vertical sync
7	GND	15	DDC clock
8	GND		

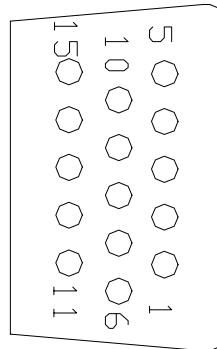

A.2 Flat Panel Display (CN2)

Table A-2: Flat panel display (CN2)

Pin	Signal	Pin	Signal
1	+12 V	14	TX1+
2	GND	15	+3.3 V
3	+12 V	16	GND
4	GND	17	TX2-
5	TXC-	18	TX2+
6	TXC+	19	KB_Data
7	+3.3 V	20	KB_Clock
8	GND	21	Power Down
9	TX0-	22	GND
10	TX0+	23	+5 V
11	+3.3 V	24	GND
12	GND	25	+5 V
13	TX1-	26	GND

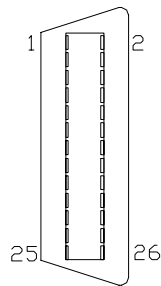

A.3 Flat Panel Display Header (JP1)

Table A-3: Flat panel display header (JP1)

Pin	Signal	Pin	Signal
1	+12 V	23	P14
2	+12 V	24	P15
3	GND	25	P16
4	GND	26	P17
5	V _{DD} SAFE	27	P18
6	V _{DD} SAFE	28	P19
7	V _{EE} SAFE	29	P20
8	GND	30	P21
9	P0	31	P22
10	P1	32	P23
11	P2	33	GND
12	P3	34	GND
13	P4	35	SFHCLK
14	P5	36	FLM
15	P6	37	M/DE
16	P7	38	LP
17	P8	39	GND
18	P9	40	ENABKL
19	P10	41	NC
20	P11	42	NC
21	P12	43	NC
22	P13	44	NC

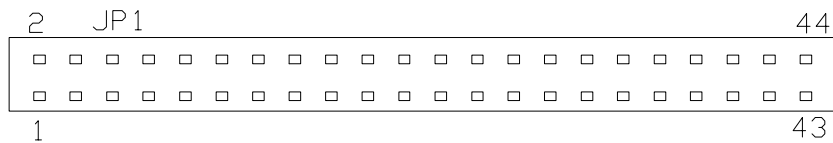

A.4 Keyboard Connector (J3)

Table A-4: Keyboard connector (J3)

Pin	Signal
1	KB_Data
2	KB_Clock

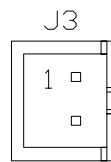

A.5 Backlight Power Connector (J10)

Table A-5: Backlight power connector (J10)

Pin	Signal
1	+12 V
2	GND
3	ENABKL
4	V_{BR}
5	+5 V

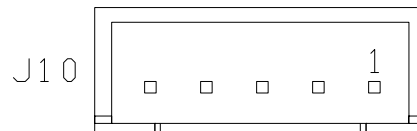

APPENDIX **B**

Pin Assignments - FPM Receiver (PanelLink)

- Flat Cable Panel Display Header (JP3)
- Flat Cable Panel Display Extension Header (JP4)
- Backlight Power (J3)
- Extension Power (J6)
- Flat Panel Display (J10)
- FFC Connector (A) For Flat Panel Display (J11)
- FFC Connector (B) For Flat Panel Display (J12)
- Keyboard Connector (J17)

B.1 Flat Cable Panel Display Header (JP3)

Pin	Signal	Pin	Signal
1	+12 V	2	+12 V
3	GND	4	GND
5	V _{DD} SAFE	6	V _{DD} SAFE
7	V _{EE} SAFE	8	GND
9	P0	10	P1
11	P2	12	P3
13	P4	14	P5
15	P6	16	P7
17	P8	18	P9
19	P10	20	P11
21	P12	22	P13
23	P14	24	P15
25	P16	26	P17
27	P18	28	P19
29	P20	30	P21
31	P22	32	P23
33	GND	34	GND
35	SHFCLK	36	FLM
37	M/DE	38	LP
39	GND	40	ENABKL
41	NC	42	NC
43	NC	44	NC

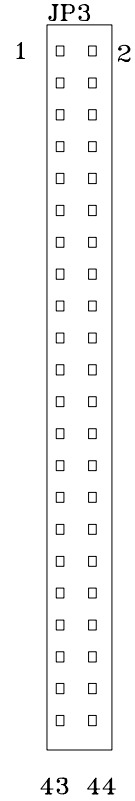

B.2 Flat Cable Panel Display Extension Header (JP4)

Table B-2: Flat cable panel display extension header (JP4)

Pin	Signal	Pin	Signal
1	V _{DD} SAFE	2	+5 V
3	P24	4	P25
5	P26	6	P27
7	P28	8	P29
9	P30	10	P31
11	P32	12	P33
13	P34	14	P35
15	GND	16	GND

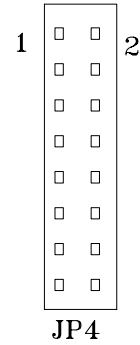

B.3 Backlight Power (J3)

Table B-3: Backlight power (J3)

Pin	Signal	Pin	Signal
1	+12 V	2	GND
3	ENABKL	4	V _{BR}
5	+5 V		



B.4 Extension Power (J6)

Table B-4: Extension power (J6)

Pin	Signal	Pin	Signal
1	+12 V	2	GND
3	GND	4	+5 V

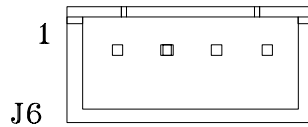

B.5 Flat Panel Display (J10)

Table B-5: Flat panel display (J10)

Pin	Signal	Pin	Signal
1	+12 V	2	GND
3	+12 V	4	GND
5	TXC-	6	TXC+
7	+3.3 V	8	GND
9	TX0-	10	TX0+
11	+3.3 V	12	GND
13	TX1-	14	TX1+
15	+3.3 V	16	GND
17	TX2-	18	TX2+
19	KB_Data	20	KB_Clock
21	Power Down	22	GND
23	+5 V	24	GND
25	+5 V	26	GND

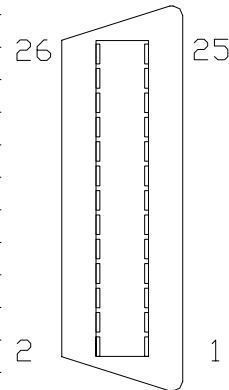

B.6 FFC Connector (A) For Flat Panel Display (J11)

Table B-6: FFC connector (A) for flat panel display (J11)

Pin	Signal	Pin	Signal
1	P0	2	P1
3	P2	4	P3
5	P4	6	P5
7	GND	8	GND
9	P6	10	P7
11	P8	12	P9
13	P10	14	P11
15	GND	16	GND
17	P12	18	P13
19	P14	20	P15
21	P16	22	P17
23	GND	24	GND
25	P18	26	P19
27	P20	28	P21
29	P22	30	P23

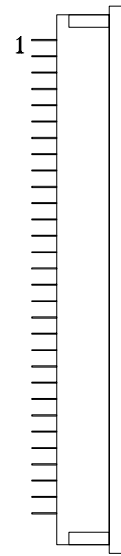

J11

B.7 FFC Connector (B) For Flat Panel Display (J12)

Table B-7: FFC connector (B) for flat panel display (J12)

Pin	Signal	Pin	Signal
1	P24	2	P25
3	P26	4	P27
5	P28	6	P29
7	GND	8	GND
9	P30	10	P31
11	P32	12	P33
13	P34	14	P35
15	GND	16	GND
17	FLM	18	LP
19	GND	20	GND
21	SHFCLK	22	M/DE
23	GND	24	GND
25	V _{EE} SAFE	26	V _{CON}
27	V _{DD} SAFE	28	V _{DD} SAFE
29	V _{DD} SAFE	30	V _{DD} SAFE

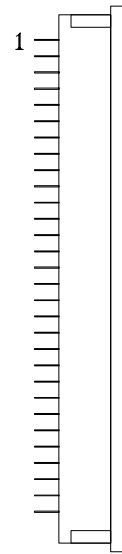

J12

B.8 Keyboard Connector (J17)

Table B-8: Keyboard connector (J17)

Pin	Signal	Pin	Signal
1	KB_Clock	2	KB_Data
3	NC	4	GND
5	+5 V		

