

1096

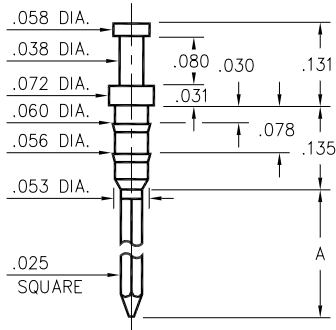

Basic Part Number	# of Wraps	Wrapost Length A
1096-2	2	.381
1096-3	3	.527

1096-X-05-XX-00-00-01-0
Press-fit in .057 mounting hole

1106

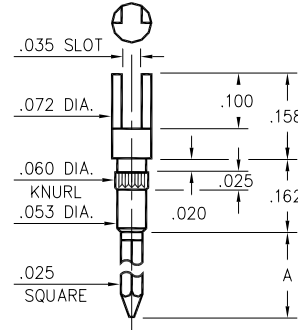

Basic Part Number	# of Wraps	Wrapost Length A
1106-2	2	.370
1106-3	3	.510

1106-X-23-XX-00-00-01-0
Press-fit in .057 mounting hole

1093

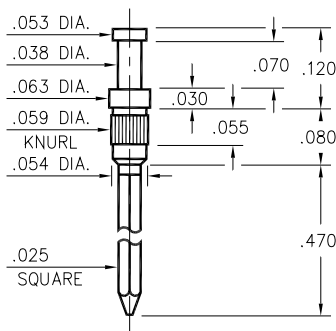

1093-0-05-XX-00-00-01-0
Press-fit in .056 mounting hole

0730

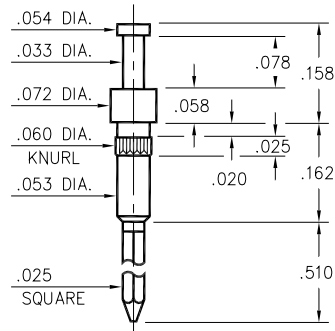

0730-3-05-XX-00-00-01-0
Press-fit in .057 mounting hole

1122

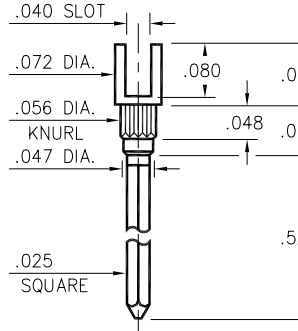

1122-0-23-XX-00-00-01-0
Press-fit in .053 mounting hole

1064

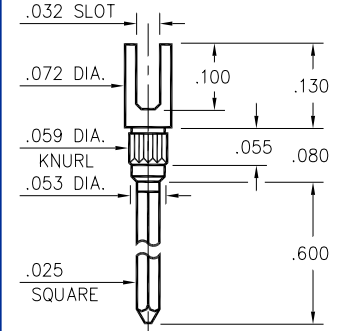

1064-0-23-XX-00-00-01-0
Press-fit in .056 mounting hole

1092

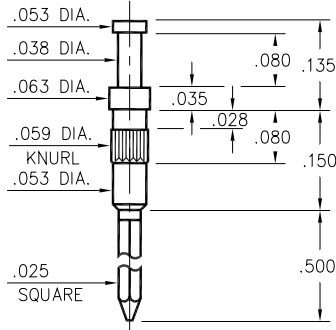

1092-0-05-XX-00-00-01-0
Press-fit in .056 mounting hole

1068

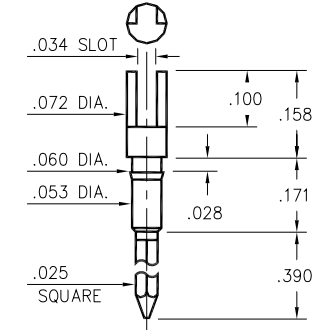

1068-0-23-XX-00-00-01-0
Press-fit in .057 mounting hole

1070 ⇒ 1072

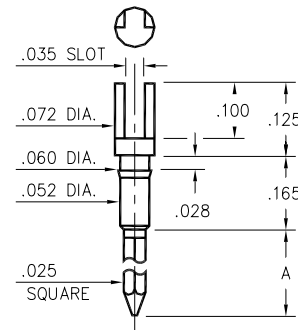

107X-X-23-XX-00-00-01-0
Press-fit in .057 mounting hole

Basic Part Number	# of Wraps	Wrapost Length A
1072-1	1	.260
1071-2	2	.370
1070-3	3	.510

SPECIFICATIONS

PIN MATERIAL:
Brass Alloy 360, 1/2 Hard

DIMENSION IN INCHES
TOLERANCES ON:
LENGTHS: ±.005
DIAMETERS: ±.002
ANGLES: ± 2°

ORDER CODE: XXXX - X - XX - XX - 00 - 00 - 01 - 0

BASIC PART # →

SPECIFY PIN FINISH:
01 200μ" TIN/LEAD OVER NICKEL
15 10μ" GOLD OVER NICKEL
21 20μ" GOLD OVER NICKEL