

Multistage Ejector



Series ZL 112/212

Energy saving, large flow rate, 3 stage diffuser construction

Suction flow rate increased 250% and air consumption reduced 20% with 3 stage diffuser construction
(Versus $\phi 1.3$, one stage model)

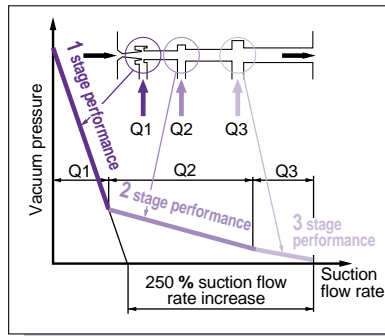

	Maximum suction flow rate /min (ANR)	Air consumption /min (ANR)
ZL112	100	63
ZL212	200	126

NEW

Series ZL212

Diffusers stacked and integrated
Compact size and large flow rate
(twice the flow rate of the ZL112)

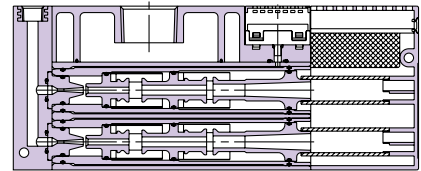

Series ZL 112 valve option now available (ZL112 only)

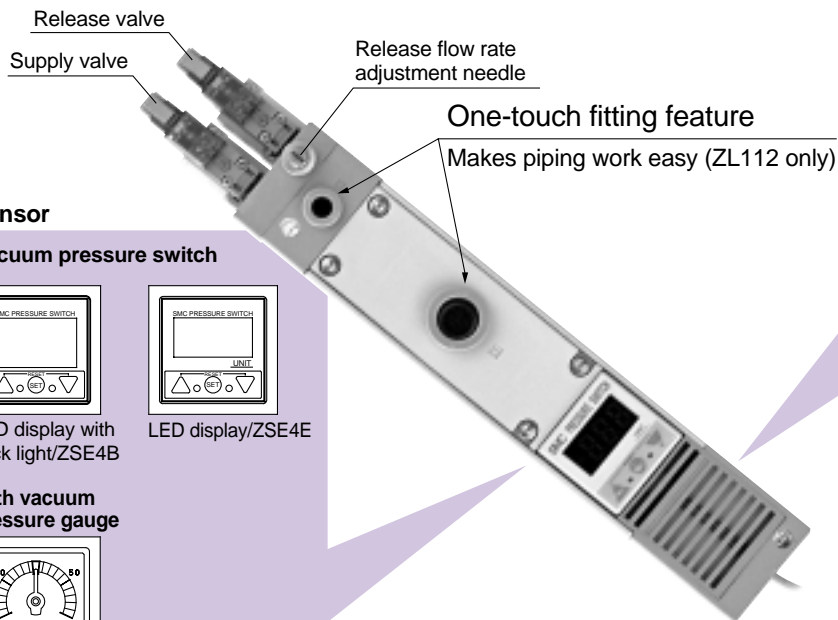

Vacuum pressure sensor

With digital vacuum pressure switch

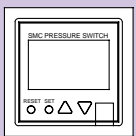

LCD display/ZSE4

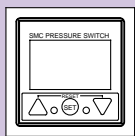

LCD display with back light/ZSE4B

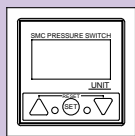

LED display/ZSE4E

With vacuum adapter

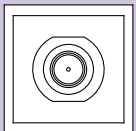

With vacuum pressure gauge

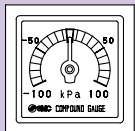

Exhaust port options

Built-in silencer

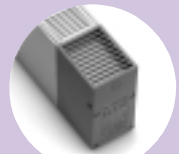

Port exhaust



Series variations

Vacuum pressure sensor options

Series	Maximum suction flow rate /min (ANR)	Air consumption /min (ANR)	Exhaust port		With valve		Digital vacuum pressure switch			Vacuum pressure gauge	Vacuum adapter
			Built-in silencer	Port exhaust	With supply valve/ release valve	With supply valve	ZSE4E	ZSE4B	ZSE4		
ZL112	100	63	●	●	●	●	●	●	●	●	●
ZL212	200	126	●	●			●	●	●	●	●

Multistage Ejector

Series ZL112

How to Order

Without valve **ZL1 12** □ □

With valve **ZL1 12** □ □ **K1 5 M Z** □ **E 25** □

• **Nozzle diameter**

12	∅1.2mm
----	--------

• **Exhaust specifications**

Nil	Built-in silencer
P	Port exhaust

• **Exhaust port thread specification (port exhaust only)**

Nil	Rc1/2
F	G1/2
N	1/2-14NPT
T	1/2-14NPTF

• **Supply valve/Release valve combination**

K1	With supply and release valves
K2	With supply valve

• **Rated voltage**

DC specifications	
5	24VDC
6	12VDC
V	6VDC
S	5VDC
R	3VDC
AC specifications (50/60Hz)	
1	100VAC
2	200VAC
3	110VAC [115V]
4	220VAC [230V]

• **Electrical entry**

G	Grommet	Lead wire length 0.3m
H		Lead wire length 0.6m
L		Lead wire length 0.3m
LN	L type plug connector	Without lead wires
LO		Without connector
M		Lead wire length 0.3m
MN	M type plug connector	Without lead wires
MO		Without connector

• **Lead wire length**

Nil	0.5m
L	2.9m

• **Digital vacuum pressure switch specifications**

For E (ZSE4) EB (ZSE4B)		
25	NPN output	Lead wire length 0.5 (2.9)m
26	Analog output	Lead wire length 0.5 (2.9)m
65	PNP output	Lead wire length 0.5 (2.9)m
For EE (ZSE4E)		
27	NPN output	Lead wire length 0.5 (2.9)m
26	Analog output	Lead wire length 0.5 (2.9)m
67	PNP output	Lead wire length 0.5 (2.9)m

* Not required for nil, vacuum adapter (GN) and vacuum pressure gauge (G).

• **Vacuum pressure sensor**

Nil	None
GN	Vacuum adapter Rc1/8
G	With vacuum pressure gauge
E	With digital vacuum pressure switch ZSE4
EB	With digital vacuum pressure switch ZSE4B
EE	With digital vacuum pressure switch ZSE4E

• **Manual override**

Nil	Non-locking push type
D	Slotted locking type

• **Light/Surge voltage suppressor**

Nil	Without light/surge voltage suppressor
S	With surge voltage suppressor
Z	With light/surge voltage suppressor
U	With light/surge voltage suppressor (non-polar type)

Note 1) Type U is 24 or 12VDC only.

Note 2) Since surge voltage is prevented by a rectifier in the case of AC, there is no "S" type.

Series ZL

Standard



With valve



With vacuum pressure gauge



Adapter



Port exhaust



Ejector Specifications

Model	ZL112
Nozzle diameter	ø1.2mm
Maximum suction flow rate	100 /min (ANR)
Air consumption	63 /min (ANR)
Maximum vacuum pressure	-84kPa
Maximum operating pressure	0.7MPa
Supply pressure range	0.2 to 0.5MPa
Standard supply pressure	0.4MPa
Operating temperature range	5 to 50°C

Supply/Release Valve Specifications

Part Number	SYJ514-□□□
Type of valve actuation	N.C.
Fluid	Air
Operating pressure range	0.2 to 0.5MPa
Ambient and fluid temperature	5 to 50°C
Response time (for 0.5MPa) ^{Note 1)}	25ms or less
Maximum operating frequency	5Hz
Manual operation	Non-locking push type, Slotted locking type
Pilot exhaust type	Pilot valve individual exhaust type, Main valve/Pilot valve common exhaust
Lubrication	Not required
Mounting position	Unrestricted
Impact/Vibration resistance ^{Note 2)}	150/30m/s ²
Enclosure	Dust proof

Note 1) Based on JIS B8374-1981 dynamic performance test. (coil temperature 20°C, at rated voltage, without surge voltage suppressor)

Note 2) Impact resistance: No malfunction when tested with a drop tester in the axial direction and at a right angle to the main valve and armature, one time each in both energized and deenergized states. (initial value)

Vibration resistance: No malfunction when tested with one sweep of 8.3 to 2000Hz in the axial direction and at a right angle to the main valve and armature, one time each in both energized and deenergized states. (initial value)

Note 3) Refer to CAT.E143-B "SYJ300/500/700" for details on valves.

Option Specifications

Vacuum pressure gauge specifications

Part number	GZ30S
Fluid	Air
Pressure range	-100 to 100kPa
Scale range (angular)	230°
Accuracy	± 3% F.S. (full span)
Class	Class 3
Operating temperature range	0 to 50°C
Material	Housing: Polycarbonate/ABS resin

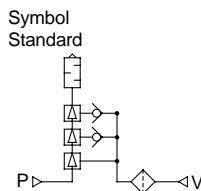

Option Specifications

With digital vacuum pressure switch (ZSE4)



Digital vacuum pressure switch specifications

Part number	ZSE4-00-□□-X105	ZSE4B-00-□□-X105	ZSE4E-00-□□-X105
Display	LCD	LCD with back light	LED
Pressure setting range	-101 to 10KPa {-760 to 75mmHg}		
Maximum operating pressure	200KPa		
Operation indicator light (lights up when ON)	Green		OUT1: Green OUT2: Red
Response frequency	200Hz (5ms)		
Hysteresis	Hysteresis mode	Variable (3 digits or more)	Variable (can be set from 0)
	Window comparator mode	Fixed (3 digits)	
Fluid	Air, Non-corrosive gas		
Temperature characteristics	±3% F.S. or less		
Repeatability	±1% F.S. or less		
Operating voltage	12 to 24VDC (ripple ±10% or less)		
Current consumption	25mA or less	45mA or less	-26, -27: 50mA or less -67: 60mA or less
Pressure indication	3 1/2 digits (character height 8mm)		
Self diagnostic function	(Over current ^{Note 1)} , Over pressure, Data error, Presence of pressure at 0 clear		
Operating temperature range	0 to 50°C (with no condensation)		
Noise resistance	500Vp-p, Pulse width: 1μS, Start up: 1nS		
Withstand voltage	Between external terminal batch and case: 1000VAC 50/60Hz for 1 min.		
Insulation resistance	Between external terminal batch and case: 2MΩ (at 500VDC)		
Vibration resistance	2hrs. each in X, Y, Z directions at smaller of 10 to 500Hz with amplitude 1.5mm, or acceleration 10G		
Impact resistance	100G in X, Y, Z directions, 3 times each		

Note 1) Not available on analog output type.

* Refer to CAT.E824-A "Pressure Switch" for details on switches.

Output specifications

ZSE4 ZSE4B	-25 (L)	1 output NPN open collector 30V, 80mA or less
	-26 (L)	Analog output (1 to 5V)
	-67 (L)	1 output PNP open collector 80mA or less
ZSE4E	-26 (L)	Analog output (1 to 5V)
	-27 (L)	2 outputs NPN open collector 30V, 80mA or less
	-67 (L)	2 outputs PNP open collector 80mA or less

* Refer to CAT.E824-A "Pressure Switch" for details on switches.

Series ZL

Construction

Without valve

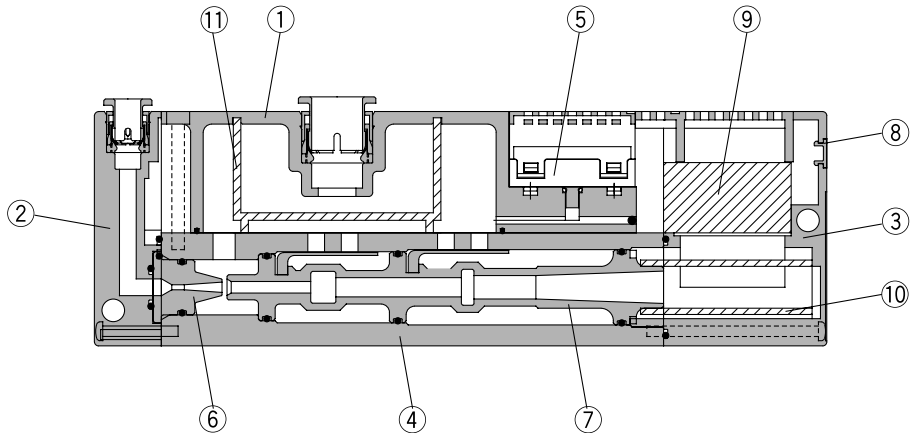

With valve

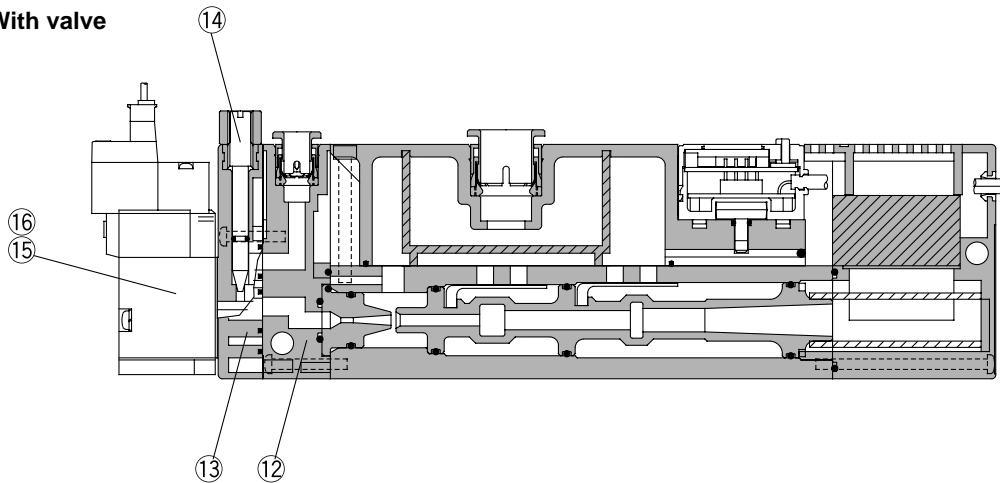

Parts list

No.	Description	Part No.	Note
1	Suction cover		
2	Front cover		Without valve
3	End cover		
4	Body		
5	Vacuum sensor unit		
6	Nozzle		
7	Diffuser		
8	Detent plug	P397110	Other than vacuum switch
	Lead wire cover	P397176	Vacuum switch specifications
12	Front cover B		With valve
13	Valve plate		With valve
14	Needle		With valve
15	Supply valve (N.C.)	SYJ514	With valve
16	Release valve (N.C.)	SYJ514	With valve

Replacement parts

No.	Description	Material	Part No.
9	Sound absorbing material B	PVF	ZL112-SP01 (set no. for 9, 10 & 11)
10	Sound absorbing material A	PVF	
11	Suction filter	PE	

* When ordering a vacuum pressure gauge or a digital vacuum pressure switch separately, use the part numbers shown in the option specifications on page 3.

Multistage Ejector *Series ZL*

Dimensions/Series ZL112 (without Valve)

**Standard
ZL112**

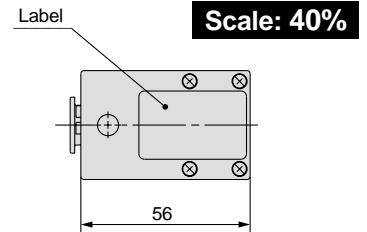
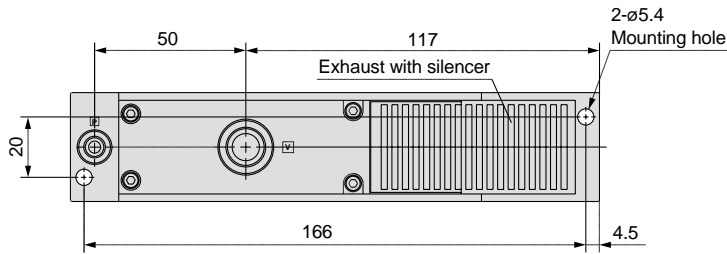

**Port exhaust
ZL112P**

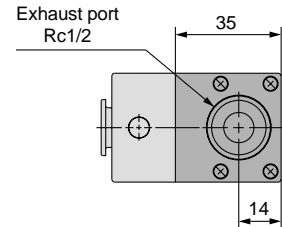
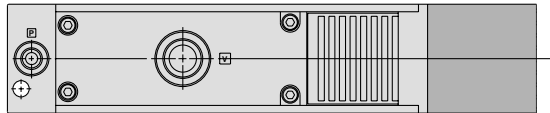

**With vacuum
pressure gauge
ZL112-G**

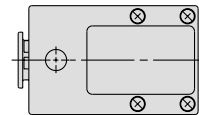
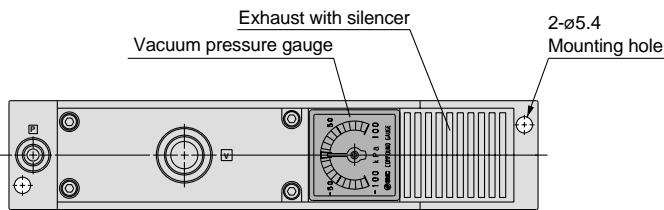

**With vacuum adapter
ZL112-GN**

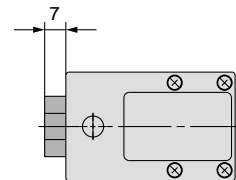
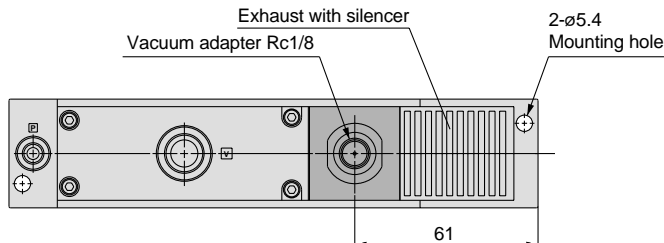

**With digital vacuum
pressure switch
ZL112-E**

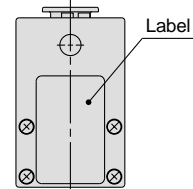
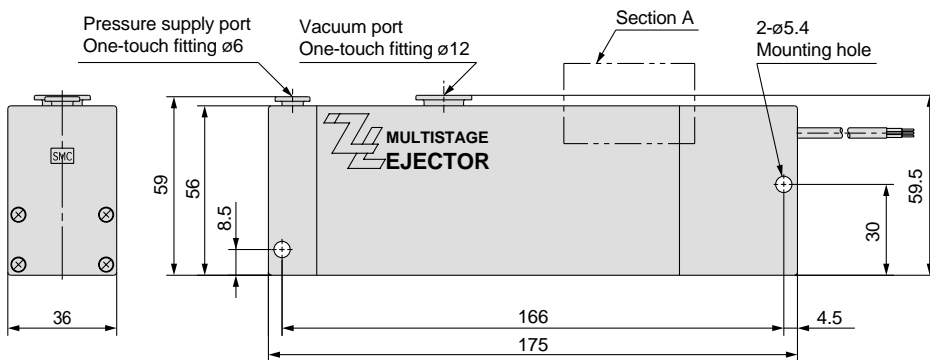
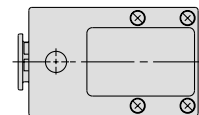
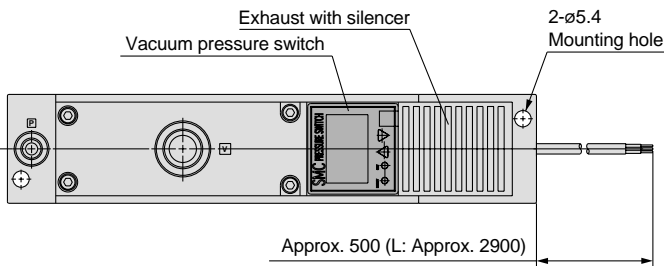

**Section A
with digital vacuum pressure switch**

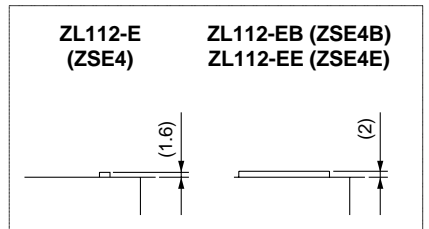

Series ZL

Dimensions/Series ZL112 (with Valve)

With supply valve and release valve ZL112-K1□L□□-E25 (L)

Scale: 40%

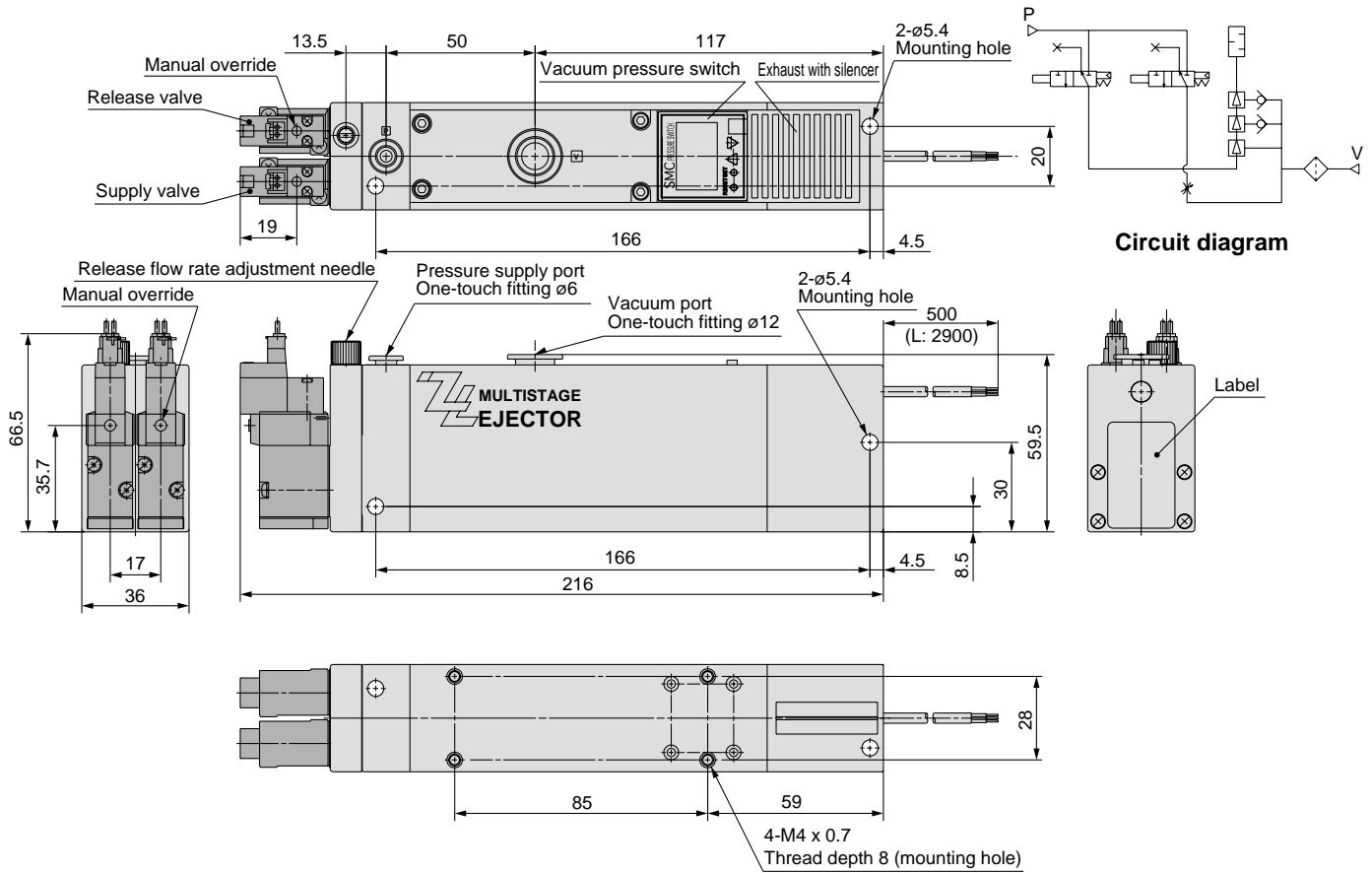

With supply valve ZL112-K2□L□□-E25 (L)

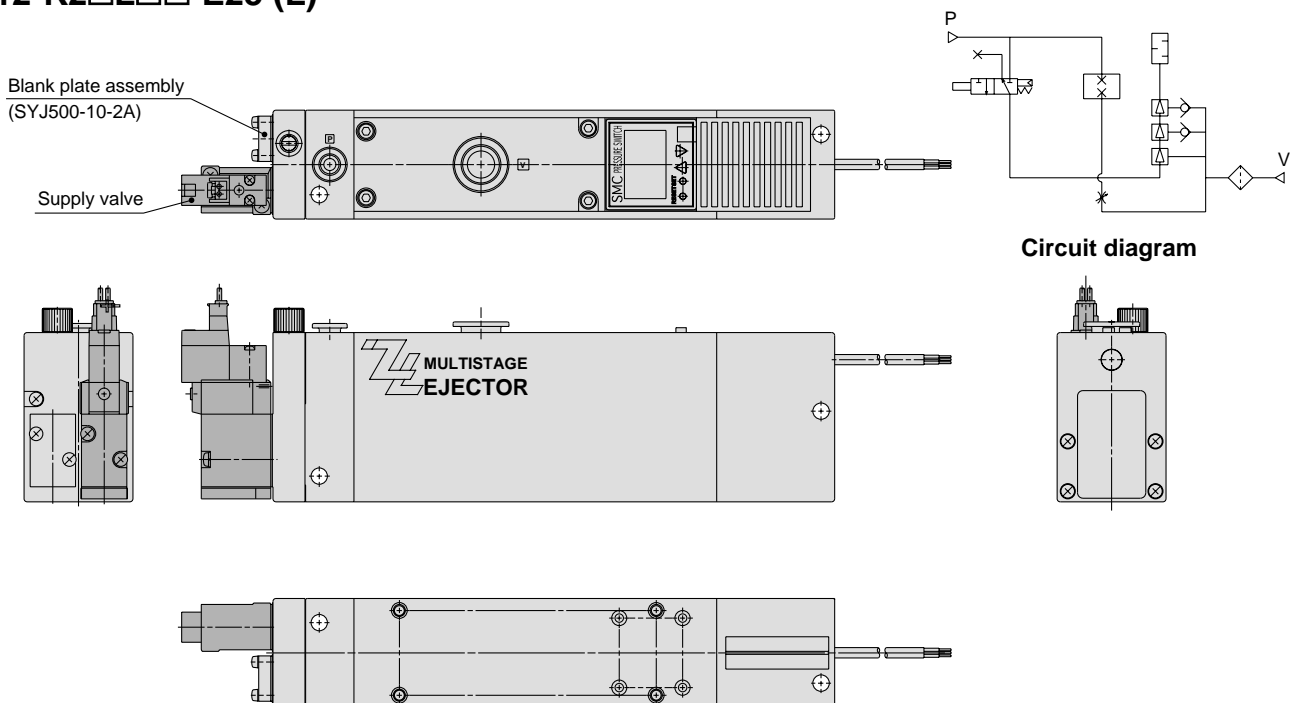

Multistage Ejector Series ZL212

Standard



With vacuum pressure gauge



With digital vacuum pressure switch



With adaptor



Port exhaust



How to Order

ZL2 12

Nozzle diameter
12 ø1.2mm

Exhaust specifications
Nil Built-in silencer
P Port exhaust

Vacuum pressure sensor

Nil	None
GN	Adaptor Rc1/8
G	With vacuum pressure gauge
E	With digital vacuum pressure switch ZSE4
EB	With digital vacuum pressure switch ZSE4B
EE	With digital vacuum pressure switch ZSE4E

Lead wire length
Nil 0.5m
L 2.9m

Digital vacuum pressure switch specifications

For E (ZSE4) EB (ZSE4B)		
25	NPN output	Lead wire length 0.6 (3.0)m
26	Analog output	Lead wire length 0.6 (3.0)m
65	PNP output	Lead wire length 0.6 (3.0)m
For EE (ZSE4E)		
27	NPN output	Lead wire length 0.6 (3.0)m
26	Analog output	Lead wire length 0.6 (3.0)m
67	PNP output	Lead wire length 0.6 (3.0)m

* Not required for nil, vacuum adaptor (GN) and vacuum pressure gauge (G).

Ejector Specifications

Model	ZL212
Nozzle diameter	ø1.2mm x 2
Maximum suction flow rate	200 /min (ANR)
Air consumption	126 /min (ANR)
Maximum vacuum pressure	-84kPa
Maximum operating pressure	0.7MPa
Supply pressure range	0.2 to 0.5MPa
Standard supply pressure	0.4MPa
Operating temperature range	5 to 50°C

* Refer to pages 2 and 3 for vacuum pressure gauge and digital vacuum pressure switch specifications.

Symbol
Standard

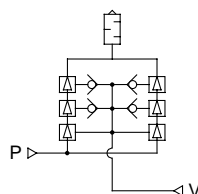

Series ZL

Construction

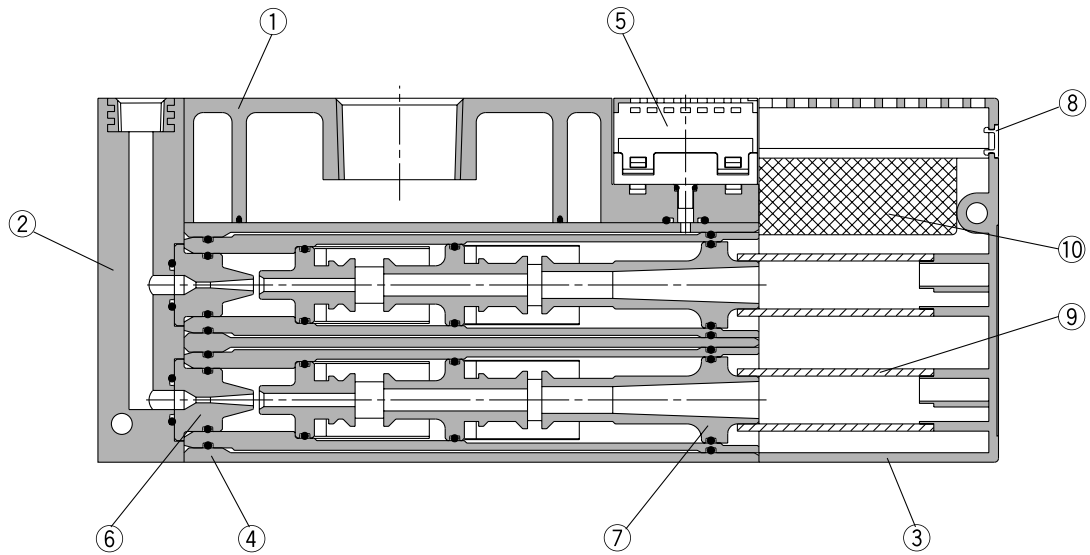

Parts list

No.	Description	Part No.	Note
1	Suction cover		
2	Front cover A		
3	End plate		
4	Body		
5	Vacuum sensor unit		
6	Nozzle		
7	Diffuser		
8	Detent plug	P397110	Other than vacuum switch
	Lead wire cover	P397176	Vacuum switch specifications

Replacement parts

No.	Description	Material	Part No.
9	Sound absorbing material A	PVF	P397114
10	Sound absorbing material	PVF	P397230

* When ordering a vacuum pressure gauge or a digital vacuum pressure switch separately, use the part numbers shown in the option specifications on page 3.

Dimensions/Series ZL212

Scale: 40%

**Standard
ZL212**

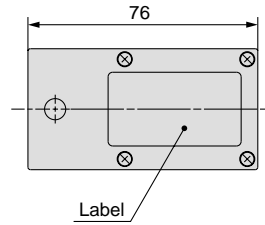
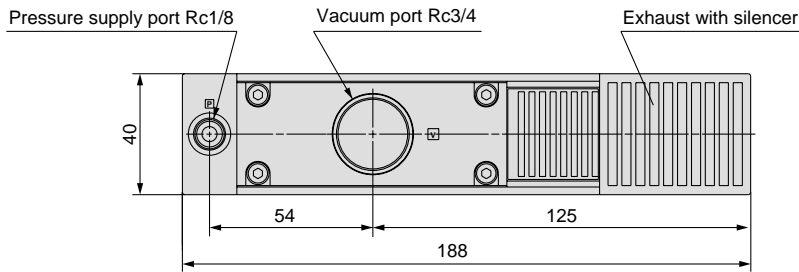

**Port exhaust
ZL212P**

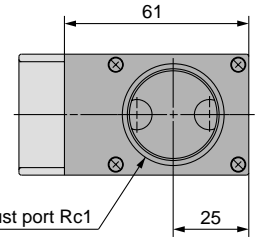
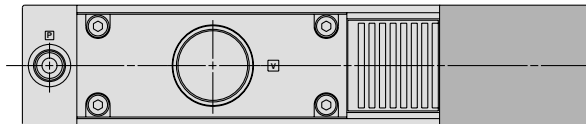

**With vacuum
pressure gauge
ZL212-G**

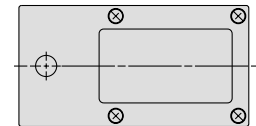
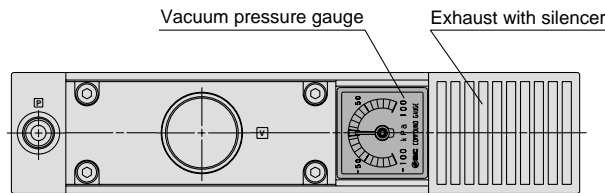

**With vacuum adapter
ZL212-GN**

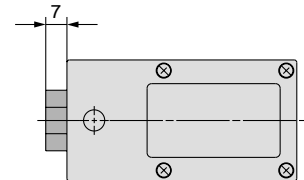
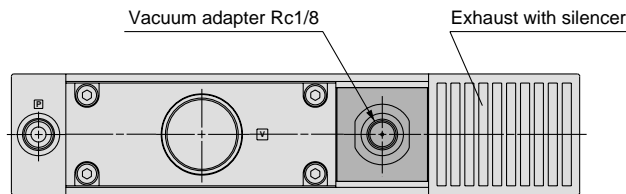

**With digital vacuum
pressure switch
ZL212-E**

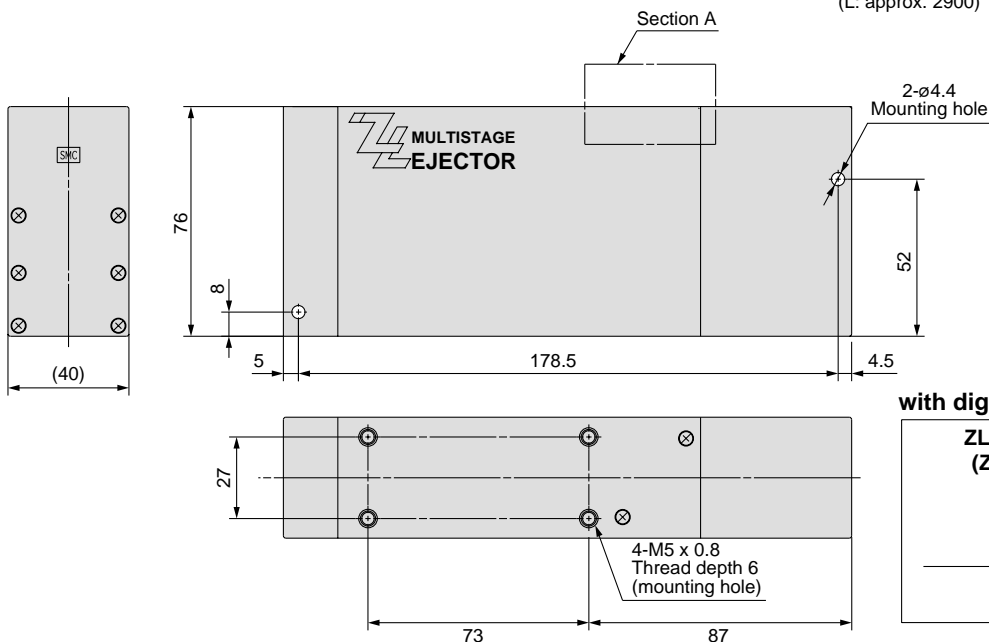
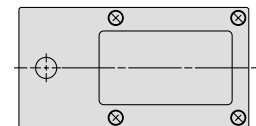
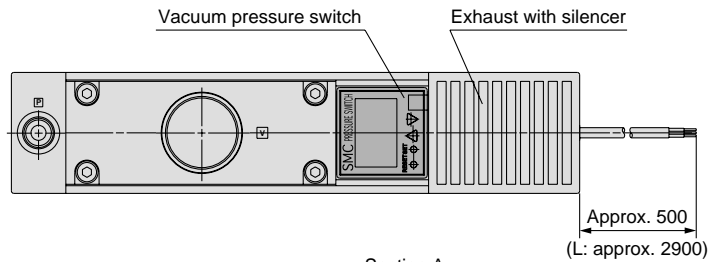

**Section A
with digital vacuum pressure switch**

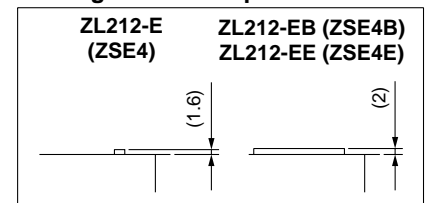





Series ZL Safety Instructions

These safety instructions are intended to prevent a hazardous situation and/or equipment damage. These instructions indicate the level of potential hazard by labels of "Caution", "Warning" or "Danger". To ensure safety, be sure to observe ISO 4414 ^{Note 1)}, JIS B 8370 ^{Note 2)} and other safety practices.

 **Caution** : Operator error could result in injury or equipment damage.

 **Warning** : Operator error could result in serious injury or loss of life.

 **Danger** : In extreme conditions, there is a possible result of serious injury or loss of life.

Note 1) ISO 4414 : Pneumatic fluid power – Recommendations for the application of equipment to transmission and control systems.

Note 2) JIS B 8370 : General Rules for Pneumatic Systems

Warning

1. The compatibility of pneumatic equipment is the responsibility of the person who designs the pneumatic system or decides its specifications.

Since the products specified here are used in various operating conditions, their compatibility for the specific pneumatic system must be based on specifications or after analysis and/or tests to meet your specific requirements.

2. Only trained personnel should operate pneumatically operated machinery and equipment.

Compressed air can be dangerous if an operator is unfamiliar with it. Assembly, handling or repair of pneumatic systems should be performed by trained and experienced operators.

3. Do not service machinery/equipment or attempt to remove components until safety is confirmed.

1. Inspection and maintenance of machinery/equipment should only be performed after confirmation of safe locked-out control positions.
2. When equipment is to be removed, confirm the safety process as mentioned above. Cut the supply pressure for this equipment and exhaust all residual compressed air in the system.
3. Before machinery/equipment is restarted, take measures to prevent shooting-out of cylinder piston rod, etc. (Bleed air into the system gradually to create back pressure.)

4. Contact SMC if the product is to be used in any of the following conditions:

1. Conditions and environments beyond the given specifications, or if product is used outdoors.
2. Installation on equipment in conjunction with atomic energy, railway, air navigation, vehicles, medical equipment, food and beverages, recreation equipment, emergency stop circuits, press applications, or safety equipment.
3. An application which has the possibility of having negative effects on people, property, or animals, requiring special safety analysis.



Series ZL Vacuum Equipment Precautions 1

Be sure to read before handling.

Selection

⚠ Warning

1. Confirm the specifications.

The products appearing in this catalog are designed for use only in compressed air systems (including vacuum). Do not use outside the specified ranges of pressure, temperature, etc., as this may cause damage or faulty operation. (Refer to specifications.) Consult with SMC if fluids other than compressed air (including vacuum) are to be used.

Mounting

⚠ Warning

1. Read the instruction manual carefully.

The product should be mounted and operated with a good understanding of its contents. Also, keep the manual where it can be easily referred to at any time.

2. Ensure space for maintenance.

Ensure the necessary space for maintenance activities.

3. Be sure to tighten screws with the proper torque.

When mounting, tighten screws with the recommended torque.

Piping

⚠ Caution

1. Preparation before piping

Before piping is connected, it should be thoroughly blown out with air (flushing) or washed to remove chips, cutting oil and other debris from inside the pipe.

2. Wrapping of pipe tape

When screwing together pipes and fittings, etc., be certain that chips from the pipe threads and sealing material do not get inside the piping.

Further, when pipe tape is used, leave 1.5 to 2 thread ridges exposed at the end of the threads.

Air Supply

⚠ Warning

1. Types of fluid

This product is designed for use with pressurized air. Consult with SMC if a different fluid is to be used.

Consult SMC regarding products to be used with general purpose fluids, to confirm which fluids may be used.

2. When there is a large amount of drainage

Pressurized air containing a large amount of drainage can cause the malfunction of pneumatic equipment. An air dryer or Drain Catch should be installed upstream from filters.

3. Drain management

If the air filter drains are not flushed regularly, the drainage will flow downstream from the drains and this may lead to the malfunction of pneumatic equipment.

In cases where the management of drain flushing will be difficult, the use of filters with automatic drains is recommended.

For details on the qualities of compressed air, refer to SMC's "Air Cleaning Equipment" catalog.

Air Supply

⚠ Warning

4. Types of air

Do not use compressed air containing chemicals, synthetic oil which includes organic solvents, salt, corrosive gases, etc., as this may cause damage or malfunction.

Operating Environment

⚠ Warning

1. Do not operate in locations having an atmosphere of corrosive gases, chemicals, sea water, fresh water or water vapor, or where there will be contact with the same.

2. In locations which receive direct sunlight, the sunlight should be blocked.

3. Do not operate in locations where vibration or impact occurs.

4. Do not operate in locations near heat sources where radiated heat will be received.

Maintenance

⚠ Warning

1. Maintenance should be performed in accordance with procedures in the instruction manual.

Improper handling may cause damage or malfunction of equipment or machinery.

2. Maintenance work

Improper handling of compressed air is dangerous. Therefore, in addition to observing the product specifications, replacement of elements and other maintenance activities should be performed by personnel having sufficient knowledge and experience pertaining to pneumatic equipment.

3. Drain flushing

Drainage should be flushed from air filter and other drains on a regular basis. (Refer to specifications.)

4. Pre-maintenance inspection

When removing this product, turn off the electric power and be certain to shut off the supply pressure and exhaust the compressed air in the system. Proceed only after confirming that all pressure has been released to the atmosphere.

5. Post maintenance inspection

After installation, repair or reconstruction, reconnect pressurized air and electric power, and then perform inspections for proper operation and air leakage. If the sound of air leakage can be heard, or if the equipment does not operate properly, stop operation and confirm that it is mounted correctly.

6. Disassembly and alteration prohibited.

Do not disassemble the unit or make any alterations to it.



Series ZL Vacuum Equipment Precautions 2

Be sure to read before handling.

Design & Selection

⚠ Warning

1. **Create a safe design, which addresses the possibility of accidents resulting from a drop in vacuum pressure due to power failure or trouble with the air supply, etc.**

If vacuum pressure drops and there is a loss of vacuum pad adsorption force, work pieces being carried may fall, causing a danger of human injury and/or damage to machinery. Safety measures should be implemented, such as the installation of drop prevention guides.

2. **Use vacuum specifications for vacuum switching valves and vacuum breakers.**

If valves which do not meet vacuum specifications are installed in vacuum piping, vacuum leakage will occur. Be certain to use vacuum specification valves.

3. **Select ejectors which have a suitable suction flow rate.**

<When there is a vacuum leak from the work piece or the piping>

If the ejector's suction flow rate is too low, this will cause poor adsorption.

<When piping is long or of large diameter>

The adsorption response time will increase due to the increased volume of the piping.

Select ejectors with a suitable suction flow rate by referring to their technical data.

4. **If the suction flow rate is too high, setting of vacuum switches will become difficult.**

In the case of adsorption on a small work piece of only a few millimeters, if an ejector is selected which has a high suction flow rate, the pressure difference when adsorbing and releasing the work piece is small. Since setting of the vacuum switch may become difficult, an appropriate ejector should be selected.

5. **When two or more pads are piped to one ejector, if one pad releases its work piece, the other pads will also release.**

When one pad is removed from its work piece, there is a drop in vacuum pressure which causes the other pads to release their work pieces also.

6. **Use piping with an adequate effective sectional area.**

Select piping for the vacuum side which has an adequate effective sectional area, so that the ejector's maximum suction flow rate can be accommodated by the piping.

Also, make sure that there are no unnecessary restrictions or leaks, etc., along the course of the piping.

The piping on the air supply side must be designed so that it corresponds to each ejector's air consumption. The effective sectional area of tubing, fittings and valves, etc., should be sufficiently large, and the pressure drop reaching the ejector should be kept to a minimum.

Further, design of the air supply should be performed while taking into consideration the ejector's maximum air consumption and the air consumption of other pneumatic circuits.

⚠ Caution

1. **For information on related items, such as directional control equipment and drive equipment, refer to the caution sections in each respective catalog.**

Mounting

⚠ Warning

1. **Do not obstruct the exhaust port of the ejector.**

If the exhaust port is obstructed when mounted, a vacuum will not be generated.

Piping

⚠ Caution

1. **Avoid disorganized piping.**

Piping which is direct and of the shortest possible length should be used for both the vacuum and supply sides, and disorganized piping should be avoided. Unnecessary length increases the piping volume, and this increases the response time.

2. **Use piping having a large effective sectional area on the exhaust side of the ejector.**

If the exhaust piping is restrictive, there will be a decline in the ejector's performance.

3. **Make sure that there are no crushed areas in the piping due to damage or bending.**

Operating Environment

⚠ Warning

1. **Do not operate in locations having an atmosphere of corrosive gases, chemicals, sea water, water or steam, or where there will be contact with the same.**

2. **Do not operate in locations having an explosive atmosphere.**

3. **Do not operate in locations where vibration or impact occurs.**

Confirm the specifications for each series.

4. **In locations which receive direct sunlight, provide a protective cover, etc.**

5. **In locations near heat sources, block off any radiated heat.**

6. **In locations where there is contact with water, oil or welding spatter, etc., implement suitable protective measures.**

7. **In cases where the vacuum unit is surrounded by other equipment or it is energized for an extended time etc., implement measures to radiate excess heat so that temperatures remain within the range of specifications.**

Maintenance

⚠ Warning

1. **Clean suction filters and silencers on a regular basis.**

The performance of ejectors will deteriorate due to clogging in filters and silencers. Large capacity filters should be used, especially in dusty locations.



Series ZL

Electronic Pressure Switch Precautions 1

Be sure to read before handling.

Design & Selection

Warning

1. Use with the specified voltage.

Use with voltage outside of the specifications can cause malfunction or switch damage, as well as electrocution and fire hazard, etc.

2. Never use a load which exceeds the maximum load capacity.

This may damage a switch or reduce its service life.

3. Do not use a load that generates surge voltage.

Although surge protection is provided at the output side of a switch, damage may still occur if the surge is applied repeatedly. When a load, such as a relay or solenoid, which generates surge is directly driven, use a type of switch having a built-in surge absorbing element.

4. Be sure to confirm the fluid specifications.

Since switches do not have explosion-proof construction, do not use flammable gases or fluids. This may cause a fire or explosion.

5. Be certain to observe the regulating pressure range and maximum operating pressure.

Operation at a pressure outside of this range can cause failure. In addition, the switch will be broken if operated above the maximum operating pressure.

Mounting

Warning

1. Do not use if equipment does not operate properly.

Verify correct mounting by suitable function and leakage inspections after air and power are connected following mounting, maintenance or conversions.

2. Do not drop or bump.

Do not drop, bump or apply excessive impact (1000m/s²) when handling. Even if the switch body is not damaged, the switch may suffer internal damage that will lead to malfunction.

3. Hold the product from the body side when handling.

The tensile strength of the power cord is 49N, and pulling it with a force greater than this can cause failure. Hold by the body when handling.

4. Turn the setting trimmer gently using a watchmakers screw driver.

Turn the setting trimmer gently using a watchmakers screw driver. Do not turn beyond the stoppers located at both ends. If the trimmer is broken, adjustment will be impossible.

5. Pressure port

Do not insert wire, etc., from the pressure port. This will damage the pressure sensor, making it impossible to obtain normal operation.

Wiring

Warning

1. Confirm wire colors and terminal numbers when wiring is performed.

Since incorrect wiring can lead to breakage or failure of the switch as well as malfunction, perform wiring after confirming wiring colors and terminal numbers with the instruction manual.

2. Avoid repeatedly bending or stretching lead wires.

Broken lead wires will result from applying bending stress or stretching force to the lead wires. In the event that lead wires are damaged creating a possibility of malfunction, replace the entire product. (For cases in which the lead wires cannot be replaced through grommets.)

3. Confirm proper insulation of wiring.

Be certain that there is no faulty wiring insulation (contact with other circuits, ground fault, improper insulation between terminals, etc.). Damage may occur due to excess current flow into a switch.

4. Do not wire with power lines or high voltage lines.

Wire separately from power lines or high voltage lines, avoiding parallel wiring or wiring in the same conduit with these lines. Control circuits containing switches may malfunction due to noise from these other lines.

5. Do not allow short circuiting of loads.

Use caution, as switches will be damaged instantly if a load is short circuited. Be especially careful not to reverse the power supply line (Brown) and the output line (Black).

Pressure Source

Warning

1. Observe the fluid and ambient temperature ranges.

The fluid and ambient temperatures are 0 to 60°C. Since moisture in circuits can freeze at 5°C or below, causing damage to O-rings and malfunction, take measures to prevent freezing. The installation of an air dryer is recommended to remove drainage and moisture from circuits. Furthermore, even though the ambient temperature range remains within specifications, do not operate in locations where there are abrupt temperature changes.

2. Vacuum pressure switches

There will be no change in performance if a pressure of 0.5MPa or less is applied for 1 second or less (when releasing a vacuum), but care should be taken that pressures of 0.2MPa or more are not applied on a regular basis.



Series ZL Electronic Pressure Switch Precautions 2

Be sure to read before handling.

Operating Environment

Warning

1. Never use in an atmosphere of explosive gases.

The structure of pressure switches is not intended to prevent explosion. Never use in an atmosphere with an explosive gas since this may cause a serious explosion.

2. Do not use in locations with sources of surge generation.

When equipment that generates a large amount of surge (solenoid type lifters, high frequency induction furnaces, motors, etc.) is located in the area around a pressure switch, there is a danger of deterioration or damage to the switch's internal circuit elements. Therefore, implement surge countermeasures at the sources, and avoid the mixing and touching of lines.

3. Operating environment

Since the electronic pressure switch is basically an open type, avoid use in locations where there is splashing of water or oil, etc.

Maintenance

Warning

1. Perform maintenance regularly and confirm normal operation.

It may otherwise not be possible to assure safety due to unexpected malfunction or misoperation, etc.

2. When used in an interlock circuit

When used in an interlock circuit, provide multiple interlock circuits as a precaution against failure, and also perform regular inspections to confirm normal operation.

3. Cleaning the case

Use a soft cloth to clean the case. In case of heavy soiling, first soak the cloth in a neutral detergent diluted with water and wring it out thoroughly. Finish up by wiping with a dry cloth.



Series ZL Specific Product Precautions 1

Be sure to read before handling.

Refer to pages 10 through 14 for safety instructions, vacuum equipment precautions and electronic pressure switch precautions.

Piping

Caution

1. Connect the compressed air supply piping separately to the solenoid valves and ejector valves. Also, connect piping to the ejector valve stations.

Operation of Ejector Valves

Caution

1. When the pilot valve for air supply is turned ON, the main valve switches, and vacuum is generated by the flow of compressed air from the nozzle to the diffuser. When the pilot valve for vacuum release is turned ON, the main valve switches, and the vacuum is quickly released as air passes through the release flow adjustment needle and flows to the vacuum port.

Environment

Caution

1. Operate away from direct sunlight.

Solenoid Valves (Series ZL112/ZL212)

Caution

1. For specific product precautions on solenoid valves (Series ZL112), refer to the solenoid valve (Series SYJ500) catalog CAT.E143-B.