

ROSS Series 27 Poppet Valves for Line Mounting

Valves in this Series are available with single or double solenoid pilots or an air head for remote pressure control. Valve elements have end-guided stainless steel stems. Flush flexible manual override buttons are standard on solenoid models. Solenoid models listed in this catalog use an internal pilot supply. They are, however, easily field-convertible for use with an external pilot supply. Models for external pilot supply may also be ordered from ROSS.

To provide special control functions, most models are also available with the following **LOGICAIR®** adaptors.

Timed Sequence Adaptor: Allows the actuation and/or de-actuation of a valve to be delayed up to 30 seconds for 2/2 valves, and up to 3 seconds for 3/2 and 4/2 valves. For longer delays see “Q” adaptor below.

“PB” Adaptor: Increases the actuating force on the valve piston. Useful with low pilot pressure.

Air Index Adaptor: Allows a single control valve to function as an impulse controlled, detented valve. Successive momentary signals from the same source actuate and de-actuate the valve.

“Q” Adaptor: For use in conjunction with the timed sequence adaptor to extend the delay interval up to 60 seconds. The “Q” adaptor also provides quicker response to actuating and de-actuating signals.



3/2 Valve with Single Solenoid Pilot

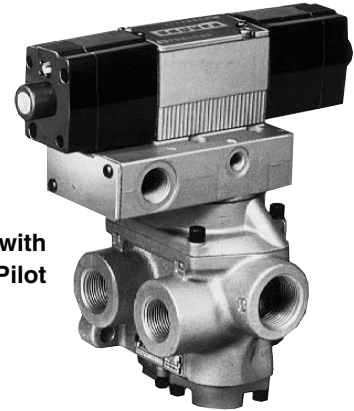

4/2 Valve with Double Solenoid Pilot

Series 27 Valve Bodies

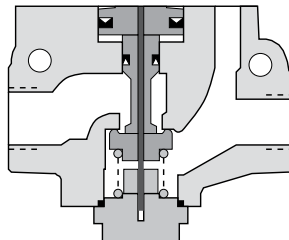

2/2 Normally Closed

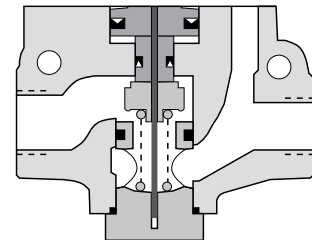

2/2 Normally Open

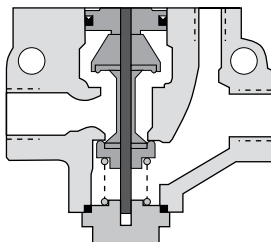

3/2 Normally Closed

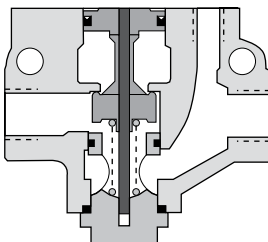

3/2 Normally Open

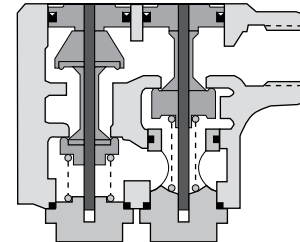

4/2

Series 27 Single Solenoid Pilot Inline Valves

2/2 Valves

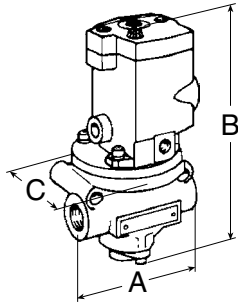

Port Size	Valve Model Numbers		Average C _v		Weight lb. (kg)
	Normally Closed	Normally Open	N.C.	N.O.	
1/4	2771B2001	2772B2001	2.3	2.3	2.5 (1.1)
3/8	2771B3001	2772B3001	3.8	3.3	
1/2	2771B4011	2772B4011	4.0	3.5	
1/2	2771B4001	2772B4001	7.7	6.5	3.3 (1.5)
3/4	2771B5001	2772B5001	9.0	7.3	
1	2771B6011	2772B6011	9.0	7.9	
1	2771B6001	2772B6001	24	21	7.0 (3.2)
1-1/4	2771B7001	2772B7001	29	20	
1-1/2	2771B8011	2772B8011	29	21	
1-1/2	2771B8001	2772B8001	49	49	15.5 (6.9)
2	2771B9001	2772B9001	57	57	
2-1/2	2771B9011	2772B9011	64	72	

Normally Closed

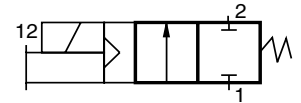

Normally Open

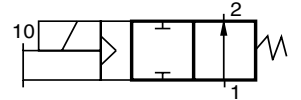

3/2 Valves

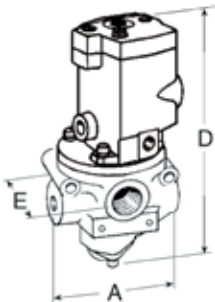

Port Sizes		Valve Model Numbers		Average C _v		Weight lb. (kg)
In-Out	Exh.	Normally Closed	Normally Open	N.C.	N.O.	
1/4	1/2	2773B2001	2774B2001	2.8	2.5	2.5 (1.1)
3/8	1/2	2773B3001	2774B3001	4.0	3.0	
1/2	1/2	2773B4011	2774B4011	3.8	3.0	
1/2	1	2773B4001	2774B4001	7.8	7.2	3.3 (1.5)
3/4	1	2773B5001	2774B5001	9.4	7.2	
1	1	2773B6011	2774B6011	10	7.2	
1	1-1/2	2773B6001	2774B6001	29	21	7.0 (3.2)
1-1/4	1-1/2	2773B7001	2774B7001	31	22	
1-1/2	1-1/2	2773B8011	2774B8011	31	21	
1-1/2	2-1/2	2773B8001	2774B8001	69	58	16.5 (7.4)
2	2-1/2	2773B9001	2774B9001	70	60	
2-1/2	2-1/2	2773B9011	2774B9011	71	55	

Normally Closed

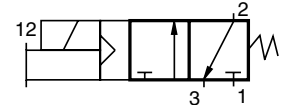

Normally Open

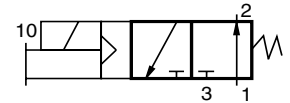

4/2 Valves

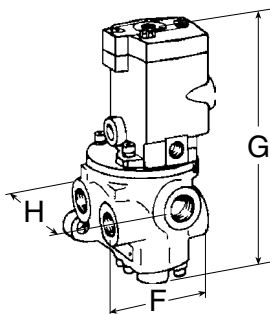

Port Sizes		Valve Model Numbers	Average C _v	Weight
In-Out	Exhaust	Numbers		lb. (kg)
1/4	1/2	2776B2001	2.5	3.0 (1.4)
3/8	1/2	2776B3001	3.6	
1/2	1/2	2776B4011	3.7	
1/2	1	2776B4001	6.9	5.3 (2.4)
3/4	1	2776B5001	8.2	
1	1	2776B6011	8.9	
1	1-1/2	2776B6001	23	11.3 (5.1)
1-1/4	1-1/2	2776B7001	24	
1-1/2	1-1/2	2776B8011	25	

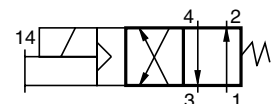

STANDARD SPECIFICATIONS: For valves on this page.

Solenoids: AC or DC power. See page 81 for voltages.

Power Consumption: 87 VA inrush, 30 VA holding on 50 or 60 Hz; 14 watts on DC.

Ambient Temperature: 40° to 120°F (4° to 50°C).

Media Temperature: 40° to 175°F (4° to 80°C).

Flow Media: Filtered air. 5 micron recommended.

Inlet Pressure:

1/4 to 1-1/2 Port Sizes: 15 to 150 psig (1 to 10 bar).

1-1/2 to 2-1/2 Port Sizes: 30 to 150 psig (2 to 10 bar).

Pilot Pressure: When external supply is used, pressure must be equal to or greater than inlet pressure.

Threads: Model numbers above specify NPT pressure port threads. For other threads, see page 81.

IMPORTANT NOTE

Please read carefully and thoroughly all of the **CAUTIONS** on page 82.

OVERALL DIMENSIONS inches (mm)

Port Size	A	B	C	D	E	F	G	H
1/4 to 1/2	3.6 (90)	6.9 (175)	3.1 (79)	7.1 (181)	3.1 (79)	3.9 (99)	7.5 (191)	3.9 (99)
1/2 to 1	4.6 (116)	7.6 (193)	3.1 (79)	7.9 (201)	3.6 (91)	4.6 (117)	9.5 (241)	5.3 (134)
1 to 1-1/2	6.6 (168)	10.3 (263)	4.1 (104)	10.3 (263)	4.8 (123)	6.5 (165)	10.8 (274)	8.3 (211)
1-1/2 to 2-1/2	8.6 (219)	11.8 (300)	5.1 (130)	12.3 (313)	6.3 (161)	—	—	—

Series 27 Remote Air Pilot Inline Valves

2/2 Valves

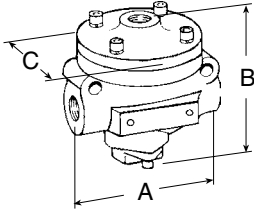

Port Size	Valve Model Numbers		Average C _v		Weight lb. (kg)
	Normally Closed	Normally Open	N.C.	N.O.	
1/4	2751A2001	2752A2001	2.3	2.3	1.3 (0.6)
3/8	2751A3001	2752A3001	3.8	3.3	
1/2	2751A4011	2752A4011	4.0	3.5	
1/2	2751A4001	2752A4001	7.7	6.5	2.0 (0.9)
3/4	2751A5001	2752A5001	9.0	7.3	
1	2751A6011	2752A6011	9.0	7.9	
1	2751A6001	2752A6001	24	21	8.0 (3.6)
1-1/4	2751A7001	2752A7001	29	20	
1-1/2	2751A8011	2752A8011	29	21	
1-1/2	2751A8001	2752A8001	49	49	14.3 (6.4)
2	2751A9001	2752A9001	57	57	
2-1/2	2751A9011	2752A9011	64	72	

Normally Closed

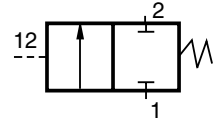

Normally Open

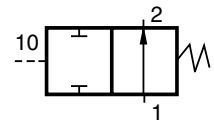

3/2 Valves

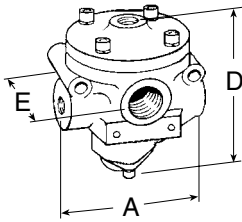

Port Sizes		Valve Model Numbers		Average C _v		Weight lb. (kg)
In-Out	Exh.	Normally Closed	Normally Open	N.C.	N.O.	
1/4	1/2	2753A2001	2754A2001	2.8	2.5	1.3 (0.6)
3/8	1/2	2753A3001	2754A3001	4.0	3.0	
1/2	1/2	2753A4011	2754A4011	3.8	3.0	
1/2	1	2753A4001	2754A4001	7.8	7.2	2.0 (0.9)
3/4	1	2753A5001	2754A5001	9.4	7.2	
1	1	2753A6011	2754A6011	10	7.2	
1	1-1/2	2753A6001	2754A6001	29	21	6.0 (2.7)
1-1/4	1-1/2	2753A7001	2754A7001	31	22	
1-1/2	1-1/2	2753A8011	2754A8011	31	21	
1-1/2	2-1/2	2753A8001	2754A8001	69	58	15.3 (6.9)
2	2-1/2	2753A9001	2754A9001	70	60	
2-1/2	2-1/2	2753A9011	2754A9011	71	55	

Normally Closed

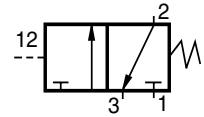

Normally Open

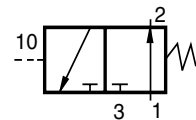

4/2 Valves

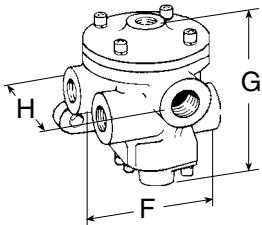

Port Sizes		Valve Model Numbers	Average C _v	Weight lb. (kg)
In-Out	Exhaust			
1/4	1/2	2756A2001	2.5	1.8 (0.8)
3/8	1/2	2756A3001	3.6	
1/2	1/2	2756A4011	3.7	
1/2	1	2756A4001	6.9	4.3 (1.9)
3/4	1	2756A5001	8.2	
1	1	2756A6011	8.9	
1	1-1/2	2756A6001	23	10.3 (4.6)
1-1/4	1-1/2	2756A7001	24	
1-1/2	1-1/2	2756A8011	25	

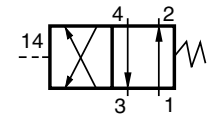

STANDARD SPECIFICATIONS: For valves on this page.
Ambient/Media Temperature: 40° to 175°F (4° to 80°C).
Flow Media: Filtered air. 5 micron recommended.
Inlet Pressure: 1/4 to 1-1/2 Port Sizes: 15 to 150 psig (1 to 10 bar). 1-1/2 to 2-1/2 Port Sizes: 30 to 150 psig (2 to 10 bar).
Pilot Pressure: Must be equal to or greater than inlet pressure.
Threads: Model numbers above specify NPT pressure port threads. For other threads, see page 81.

IMPORTANT NOTE
 Please read carefully and thoroughly
 all of the **CAUTIONS** on page 82.

Port Size	OVERALL DIMENSIONS inches (mm)							
	A	B	C	D	E	F	G	H
1/4 to 1/2	3.6 (90)	3.7 (94)	3.0 (77)	4.0 (101)	3.1 (79)	3.9 (99)	4.0 (101)	3.9 (99)
1/2 to 1	4.6 (116)	4.4 (112)	3.0 (77)	4.7 (120)	3.6 (91)	4.6 (117)	5.8 (147)	5.3 (134)
1 to 1-1/2	6.6 (168)	7.4 (188)	4.1 (104)	7.4 (188)	4.8 (123)	6.5 (165)	7.5 (190)	8.3 (211)
1-1/2 to 2-1/2	8.6 (219)	9.1 (231)	5.1 (130)	9.5 (240)	6.3 (161)	6.5 (165)	7.8 (198)	8.2 (208)

Series 27 Double Solenoid Pilot Inline Valves

4/2 Valves

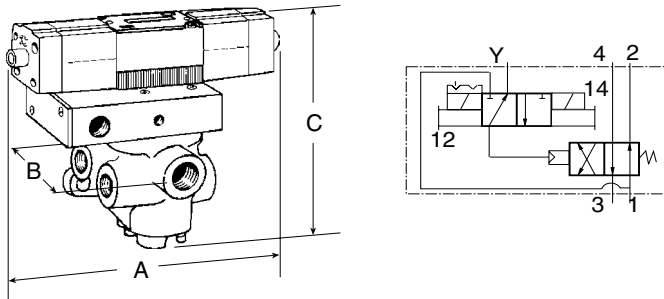

OVERALL DIMENSIONS inches (mm)

Port Size	A	B	C
1/4 to 1/2	9.4 (239)	3.9 (99)	7.9 (201)
1/2 to 1	9.4 (239)	5.3 (134)	9.7 (246)
1 to 1-1/2	9.4 (239)	8.2 (208)	11.6 (295)

IMPORTANT NOTE

Please read carefully and thoroughly all of the **CAUTIONS** on page 82.

Port Sizes In-Out	Exhaust	Valve Model Numbers	Average C _v	Weight lb. (kg)
1/4	1/2	2776B2003	2.5	
3/8	1/2	2776B3003	3.6	4.0 (1.8)
1/2	1/2	2776B4013	3.7	
1/2	1	2776B4003	6.9	
3/4	1	2776B5003	8.2	6.3 (2.8)
1	1	2776B6013	8.9	
1	1-1/2	2776B6003	23	
1-1/4	1-1/2	2776B7003	24	12.3 (5.5)
1-1/2	1-1/2	2776B8013	25	

STANDARD SPECIFICATIONS: For valves on this page.
Solenoids: AC or DC power. See page 81 for voltages.
Power Consumption: Each solenoid; 190 VA inrush, 40 VA holding on 50 or 60 Hz; 20 watts on DC.
Indicator Lights: In each solenoid housing.
Ambient Temperature: 40° to 120°F (4° to 50°C).
Media Temperature: 40° to 175°F (4° to 80°C).
Flow Media: Filtered air. 5 micron recommended.
Inlet Pressure: 15 to 150 psig (1 to 10 bar).
Pilot Pressure: If external supply is used, pressure must be equal to or greater than inlet pressure.
Threads: Model numbers above specify NPT pressure port threads. For other threads, see page 81.

Indicator Light Kit

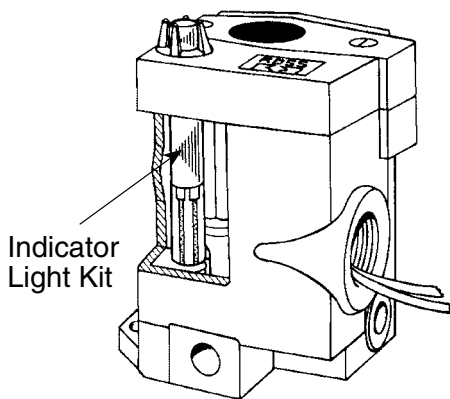

An indicator light extends through the solenoid or pilot cover and is illuminated when the solenoid is energized. Such lights are standard on double solenoid valves in Series 21 and 27.

An indicator light is available in kit form for single solenoid models in Series 16, Series 21 (type O only), and Series 27. Order kit number **862K87** and specify the voltage of the solenoid.

Manual Override Kits

Flush flexible manual overrides are standard on single solenoid models in Series 16 and Series 27. Double solenoid models in Series 21 and 27 have flush metal-button overrides. Both types are non-locking.

Each of the buttons in the override kits below is made of metal and is spring-returned. The locking type button, however, can be kept in the actuated position by turning the slot in the top of the button with a screwdriver.

Order by the kit numbers shown below.

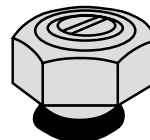

FLUSH BUTTON

Locking type Kit **792K87**
 Non-locking type..... Kit **790K87**

EXTENDED BUTTON WITH PALM ACTUATOR
 Non-locking type
 Kit **984H87**

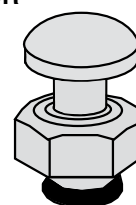

EXTENDED BUTTON
 Non-locking type
 Kit **791K87**

