



AQ062W48V025V25AN

48V_{in} 25A_{out} 2.5V_{out} DC-DC Converter High Efficiency, Isolated Quarter Brick

Features

- Very high efficiency: 90%
- Wide input voltage range (36 to 75Vdc)
- Low profile, industry standard footprint and pin out: 2.3" x 1.45" x 0.36" (58.4mm x 36.8mm x 9.35mm)
- Total weight: 34g. (1.2oz.)
- Remote ON/OFF
- Output voltage trim
- Remote sense
- Fixed Frequency (Input-Output ripple 400 KHz)
- Under voltage lockout (UVLO) – auto recover
- Over voltage protection – auto recover
- Over current protection – auto recover
- Over temperature protection – auto recover
- Operating temperature -40/+100 °C
- Input to Output Isolation at 2000Vdc, 10MΩ
- CSA/US, CSA, TUV and KEMA Certified
- ISO 9001 Certified manufacturing processes

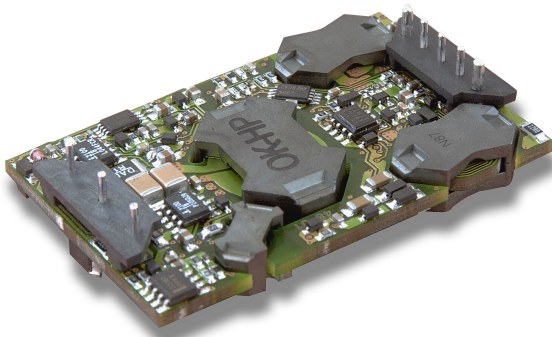
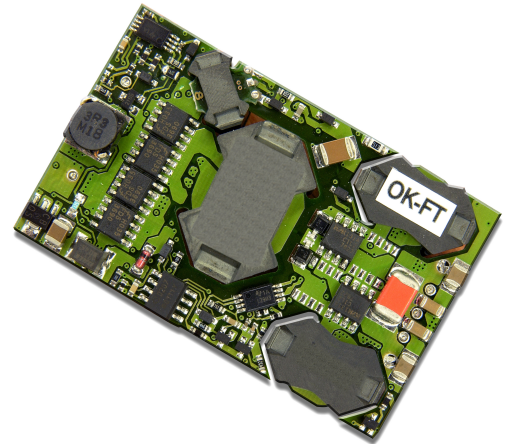

Product Highlights

- The AQ Family of dc-dc converters is Ault's solution for next generation, cutting-edge board applications.
- Synchronous rectification uses MOSFET instead of Schottky diodes providing extreme reduction in heat generation, boosting efficiency, eliminating the need for a heat sink and increased reliability.
- Low profile (0.36"), open frame construction allows smaller card pitch and improves system ventilation.
- Fixed switching frequency provides predictable EMI characteristics.

AQ062W-48V-2.5V High Efficiency DC-DC Converter



DIMENSIONS

DIMENSIONS ARE IN INCHES AND (MILLIMETERS)
 TOLERANCE: x.xx in. ±0.02 in. (0.5 mm)

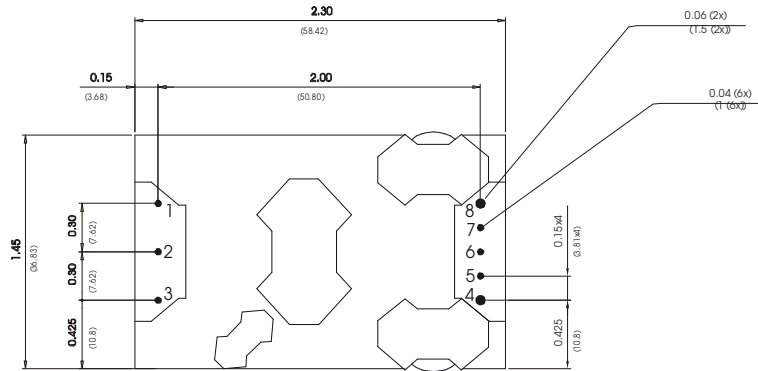

BOTTOM VIEW

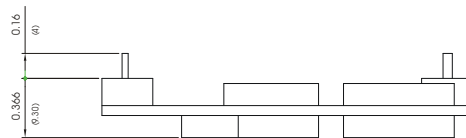

SIDE VIEW

PIN CONNECTIONS	
PIN NO.	FUNCTION
1	- Vin
2	Remote ON/OFF
3	+ Vin
4	+ Vout
5	+ Sense
6	Trim
7	- Sense
8	- Vout

AQ062W–48V–2.5V High Efficiency DC-DC Converter



Specifications

(Typical value standard at nominal input line, full load, airflow 300 LFM, 25°C ambient temperature unless otherwise specified)

Input Characteristics	Notes & Conditions	Min	Typ	Max	UNITS
Operating Input Voltage Range	Note 1	36	48	75	V
Input Under-Voltage Lockout					
<i>Turn-On Voltage Threshold</i>		34.3	34.8	35.4	V
<i>Turn-Off Voltage Threshold</i>		33.8	34.3	34.8	V
<i>Lockout Hysteresis Voltage</i>		0.4	0.5	0.6	V
Maximum Input Current (I_{INmax})	$V_{IN}=36V$; Full Load			1.95	A
No-load Input Current		40	55	65	mA
Off Converter Input Current			4	6	mA
Inrush Current Transient Rating			0.01		A ² s
Input Reflected-Ripple Current	RMS, See figure 1		3		mA

NOTE 1: Absolute max. input voltage 80V

Output Characteristics	Notes & Conditions	Min	Typ	Max	Units
Output Voltage Set Point	50% Load	2.48	2.5	2.52	V
Output Voltage Regulation					
<i>Load</i>	$V_{nom} = 48V$		± 5	± 8	mV
<i>Line</i>	$I = 15A$		± 2	± 5	mV
<i>Temperature</i>			± 15	± 30	mV
Total Output Voltage Range		2.475		2.535	V
Output Voltage Ripple and Noise	20 MHz bandwidth				
<i>Peak to Peak</i>	Full load;		50	70	mV
<i>RMS</i>	see figures 1, 4		14	20	mV
Operating Output Current Range		0	-	25	A
Output DC Current Limit Inception		26	27	29	A
Output DC Current Limit Shutdown Voltage	See figure 5	2	2.1	2.2	V
Admissible Output Capacitance	Full load, resistive	0		20.000	μF

Dynamic Characteristics	Notes & Conditions	Min	Typ	Max	Units
Output Voltage Current Transient	470μF load cap, 1A/μs; see figure 9				
<i>Positive Step Change</i>	50% I_o to 75% I_o		160		mV
<i>Negative Step Change</i>	75% I_o to 50% I_o		160		mV
<i>Settling Time to 1%</i>			300		μs
Turn-On Transient	See figures 6 and 7				
<i>Overshoot</i>			0		%
<i>Turn-On Time</i>	Full load		15	20	ms
<i>Start-Up Inhibit Period</i>			120		ms

Efficiency	Notes & Conditions	Min	Typ	Max	Units
100% Load			90		%
80% Load			90		%
56% Load			90		%

Isolation Characteristics	Notes & Conditions	Min	Typ	Max	Units
Isolation Voltage - input to output	Basic Isolation		2000		V _{DC}
Isolation Capacitance	Basic Isolation		2200		pF
Isolation Resistance		10			MΩ

AQ062W–48V–2.5V High Efficiency DC-DC Converter



Feature Characteristics		Min.	Typ.	Max	Units
Switching frequency	Double Frequency for Input-Output Ripple	190	200	210	kHz
ON/OFF Control					
	Off-State Voltage	2.7		10	V
	On-State Voltage	0		0.5	V
	Output Voltage Trim Range	-10		+10	%
	Output Voltage Remote Sense Range			+10	%
	Output Over-Voltage Protection	115	119	123	%
	Overcurrent Protection Threshold	26-35 A			
	Over-Temperature shutdown	Average PCB temperature		125	°C

General Characteristics	Notes & Conditions	Min	Typ	Max	Units
Operating Range Temperature	Maximum Rating	-40		+100	°C
Storage Temperature	Maximum Rating	-50		+120	°C
Relative Humidity	Non condensing	5		95	%
Calculated MTBF	Bellcore Issue 4 RDF93 HRD Issue 5	Min. 1,500,000 hours			
Approvals		EN60955; UL1950; CSA22.2; CE			

Safety and Regulatory	
TUV and KEMA certified for compliance to EN 06950 requirements	
CSA 22.2 No. 950-95(US and Canada) certified with basic insulation for compliance to UL 1950.	
Note : An external input fuse must always be used for compliance to listed safety requirements.	
CE compliant per 72/23/EEC (Low voltage directive) and 93/68/EEC to facilitate CE Mark at system level.	
Material flammability rating, UL94V-0	
NEBS compliant	

Characteristic Curves

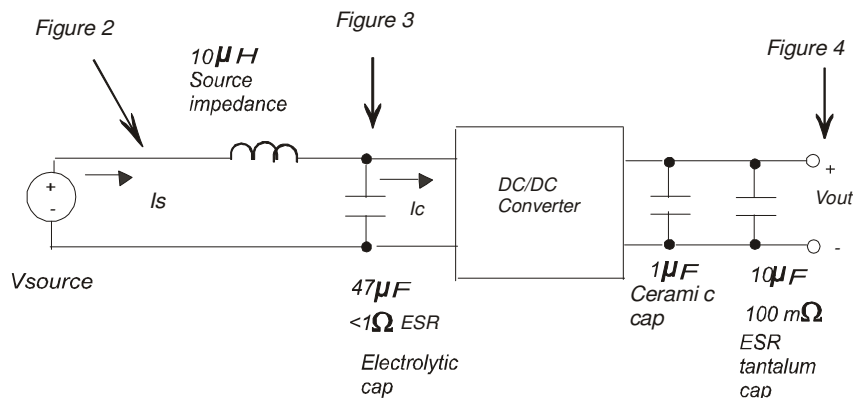

FIGURE 1: Set-up diagram showing measurement points for:
 Input Terminal Ripple Current, Input Reflected
 Ripple Current and Output Voltage Ripple

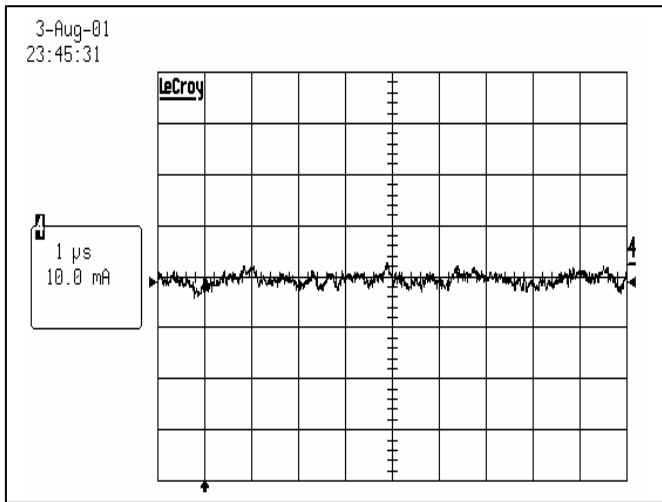

FIGURE 2: Input Reflected Ripple Current, set-up per figure 1; 10 μ H source impedance. Nominal input voltage at full rated load.

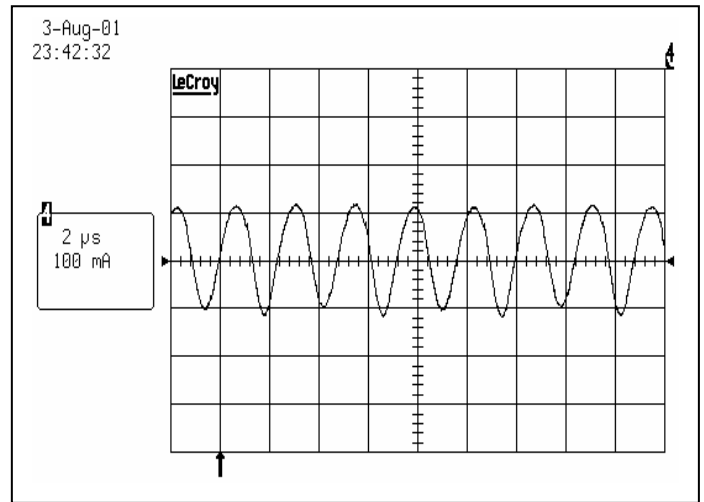

FIGURE 3: Input Terminal Ripple Current, set-up per figure 1; 10 μ H source impedance and 47 μ F electrolytic capacitor Nominal input voltage at full rated load.

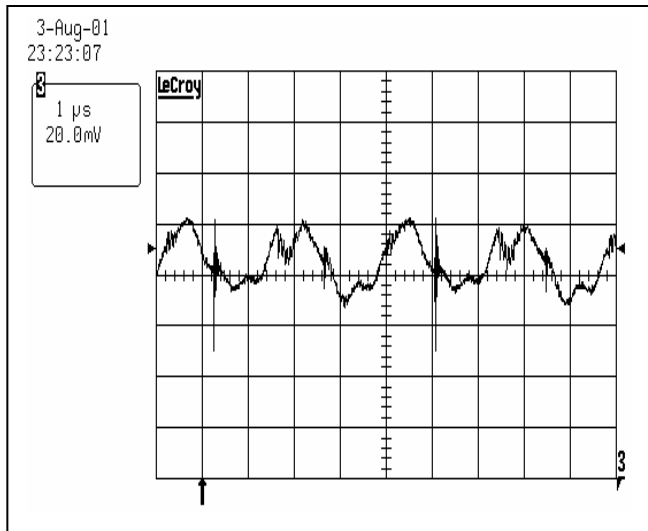

FIGURE 4: Output Voltage Ripple, set-up per figure 1; 1 μ F ceramic capacitor and 10 μ F tantalum capacitor. Nominal input voltage at full rated load

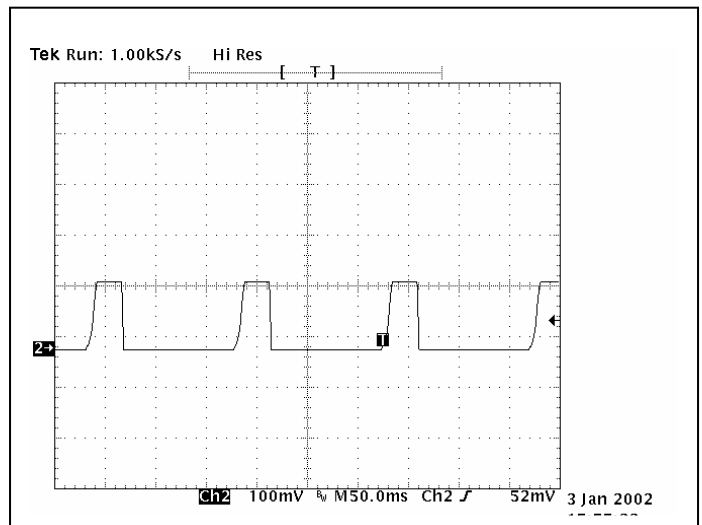

FIGURE 5: Load current as a function of time while attempting to enable into a short circuit, <10m Ω .

AQ062W-48V-2.5V High Efficiency DC-DC Converter

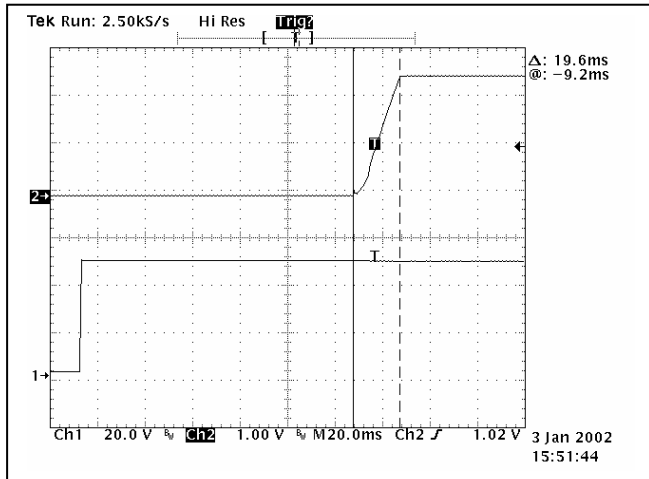

FIGURE 6: Turn-on transient at full rated load.
Upper trace: output voltage.
Lower trace: input voltage

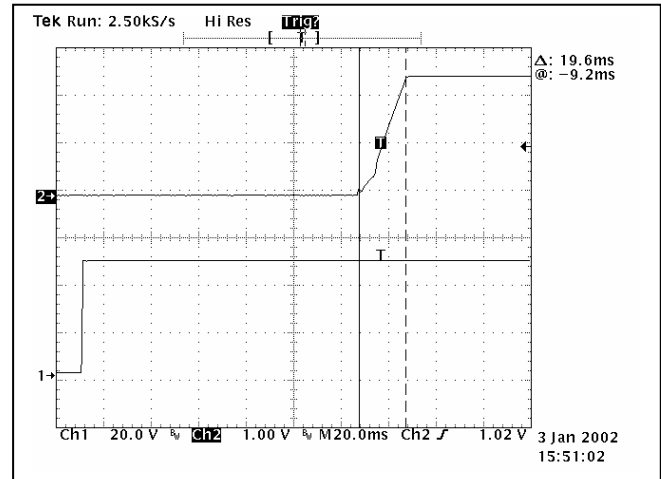

FIGURE 7: Turn-on transient at zero load.
Upper trace: output voltage
Lower trace: input voltage

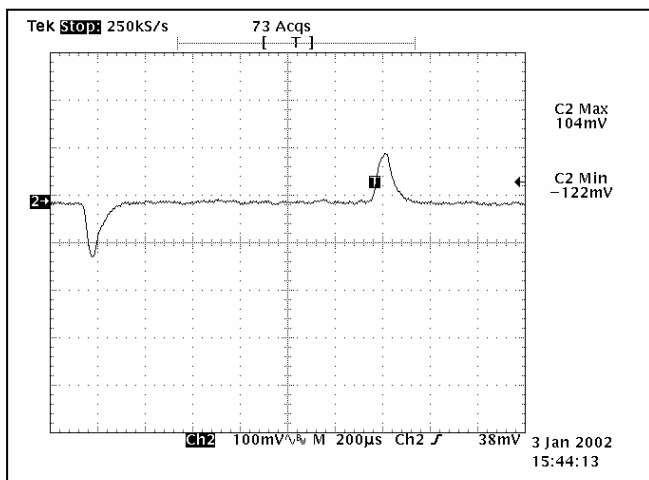

FIGURE 8: Output voltage response to dynamic change in load current: $75\% I_o$ to $50\% I_o$, where $di/dt = 0.1A/\mu s$
Load cap: $10\mu F$, $100\text{ m}\Omega$ ESR tantalum capacitor and $1\mu F$ ceramic capacitor

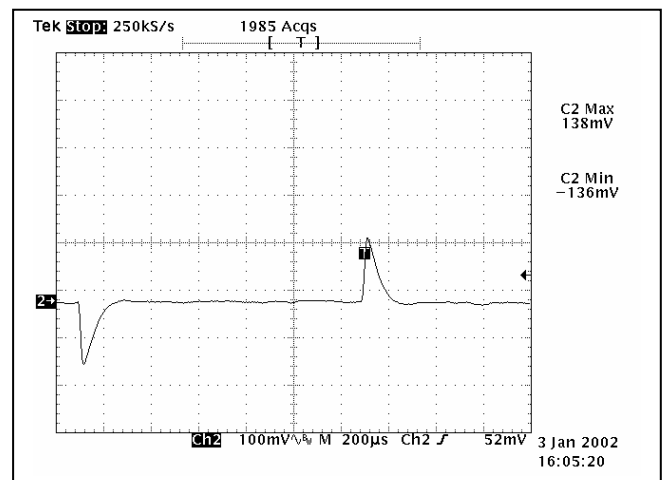

FIGURE 9: Output voltage response to step-change in load current. $50\% I_o$ to $75\% I_o$, where $di/dt = 1A/\mu s$
Load cap: $470\mu F$, $30\text{ m}\Omega$ ESR tantalum capacitor and $1\mu F$ ceramic capacitor

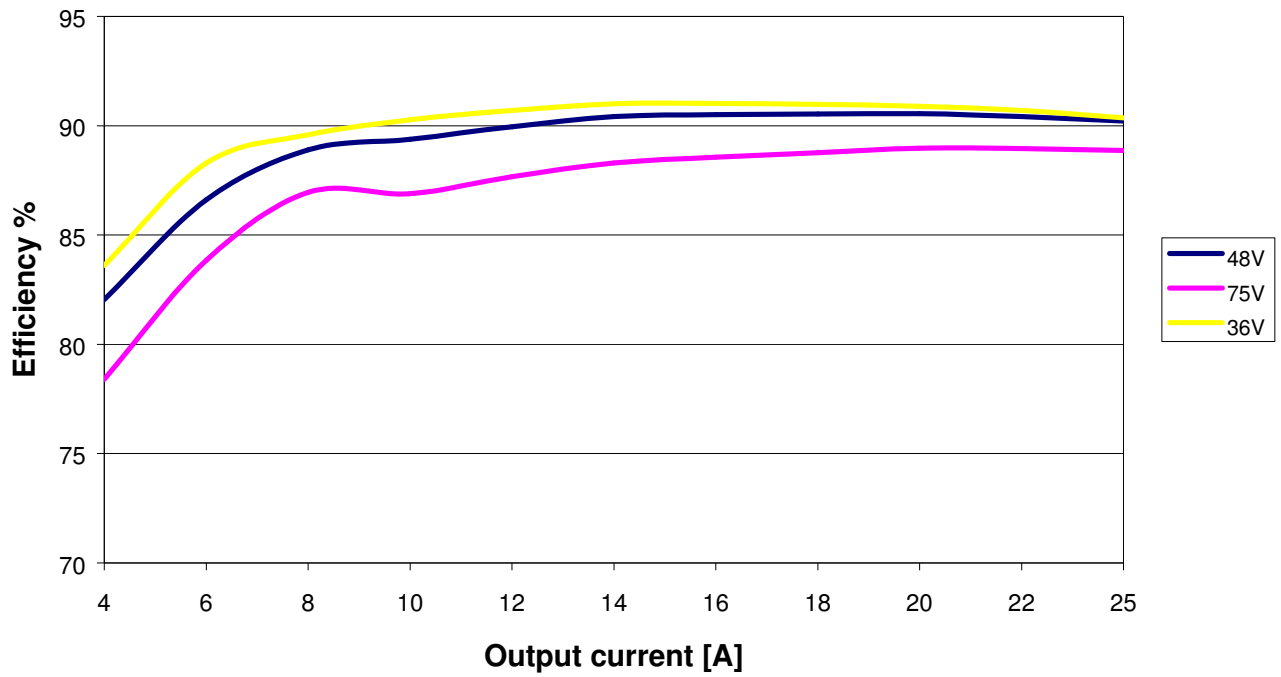

FIGURE 10: Efficiency vs. load current for different input voltages at 25°C

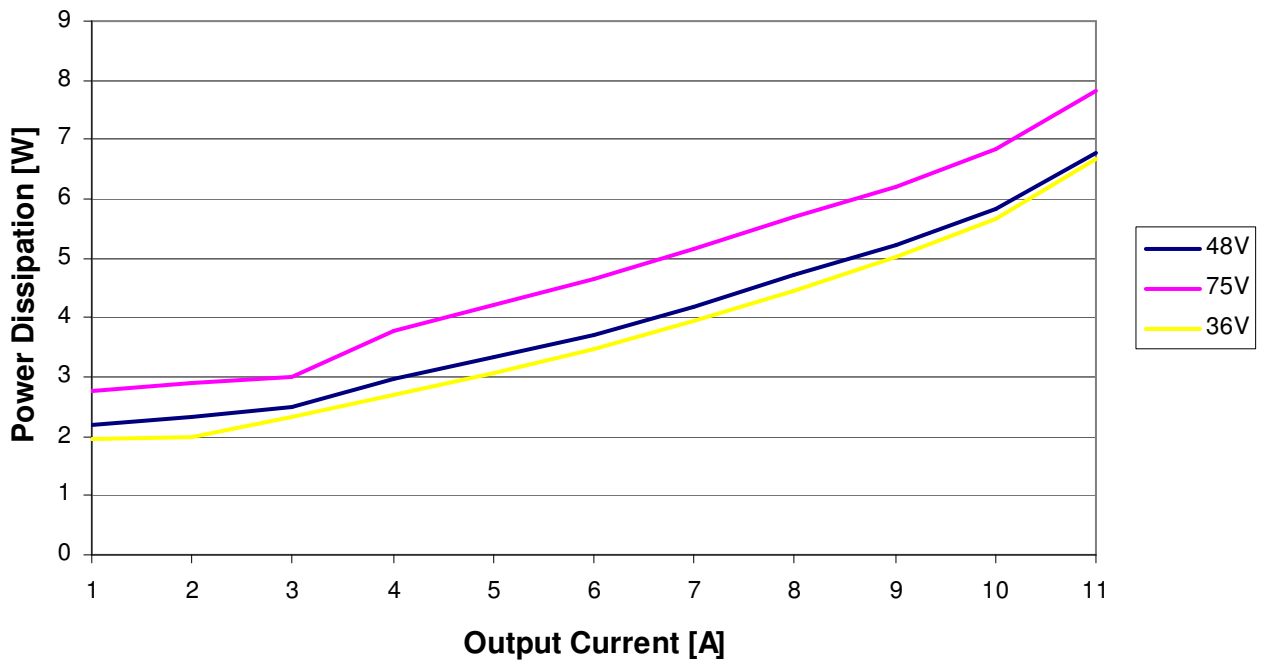

FIGURE 11: Power dissipation vs. load current for different input voltages at 25°C

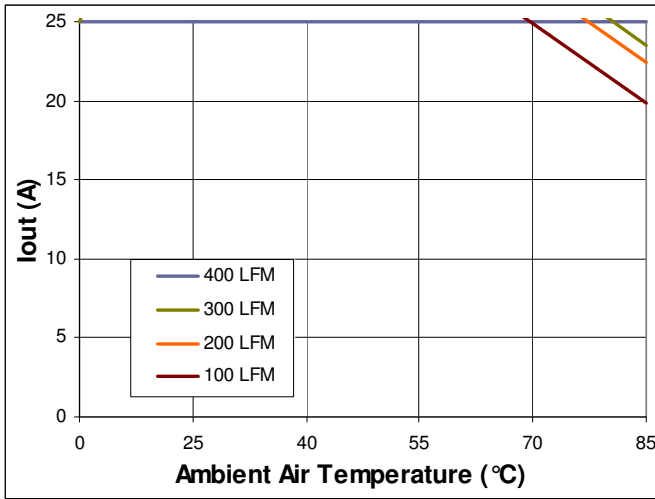

FIGURE 12: Maximum output current derating curves vs. ambient air temperature. Airflow rates of 100 LFM through 400 LFM with air flowing across the converter from pin 1 to pin 3 at nominal input voltage.

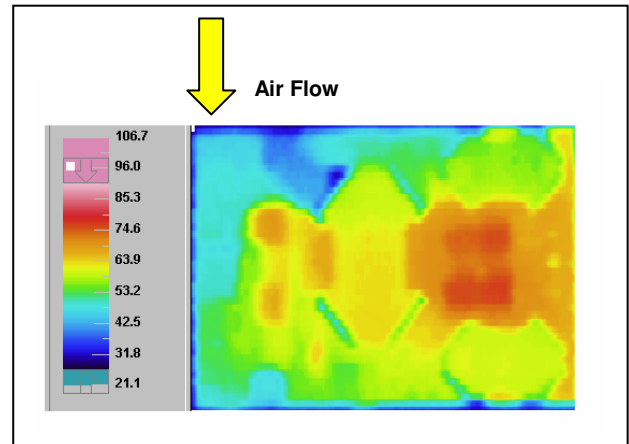

FIGURE 13: Thermal plot of converter: 25 A load, with 25°C air flowing at the rate of 200 LFM. Air is flowing across the converter from pin 1 to pin 3, at nominal input voltage.

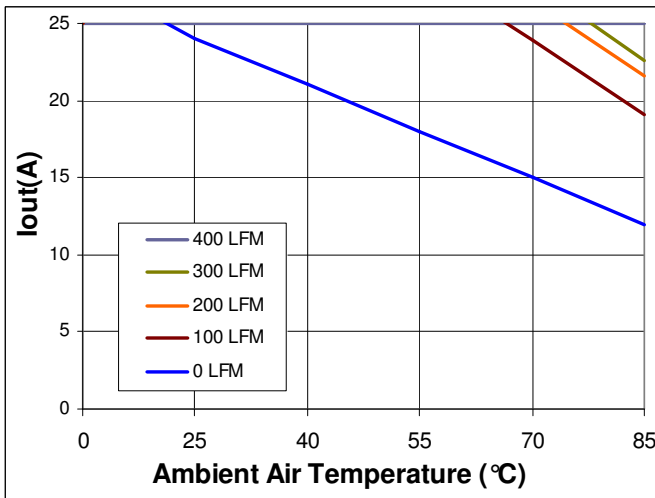

FIGURE 14: Maximum output current derating curves vs. ambient air temperature. Airflow rates of 0 LFM through 400 LFM with air flowing lengthwise from input to output at nominal input voltage.

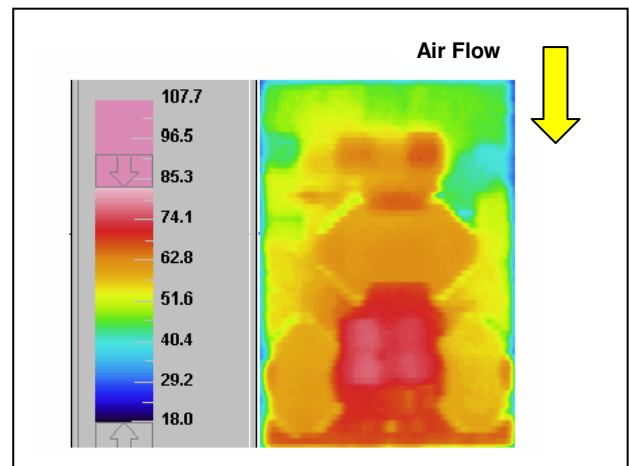
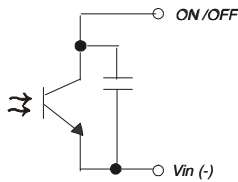

FIGURE 15: Thermal plot of converter: 25 A load with 25°C air flowing at the rate of 200 LFM. Air is flowing across the converter from input to output, at nominal input voltage.

Features and Pins description

REMOTE ON-OFF CONTROL

The default logic is negative, where the Remote On/Off (pin 2) input is referenced to -Vin (pin 1). The Remote On/Off signal must be lower than 0.8V to enable the output voltage, and higher than 2.7V to disable the output voltage. Positive logic is an available option, add “-P” to the end of the ordering code.



Remote Enable Circuit

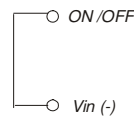

Negative logic
(permanently Enabled)

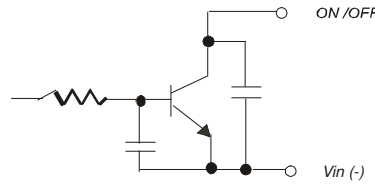

Open Collector Enable Circuit

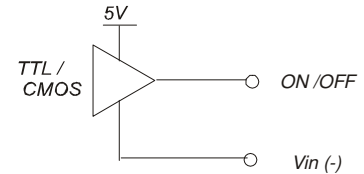

Direct Logic Drive

TRIM

The output voltage can be trimmed by means of an external resistor connected between Trim (pin 6) and +Sense (pin 5) or -Sense (pin 7). The selection of the resistor follows the industry standard trim equation.

An external resistor connected between Trim and –Sense pins will decrease the output voltage. For a decrease of Δ% of the nominal output voltage, calculate the value of the external resistor using the following equation:

$$R_{\text{trim-down}} = \left(\frac{511}{\Delta\%} \right) - 10.22k\Omega \quad \text{where} \quad \Delta = \left(\frac{2.5 - V_{\text{target}}}{2.5} \right) \times 100\%$$

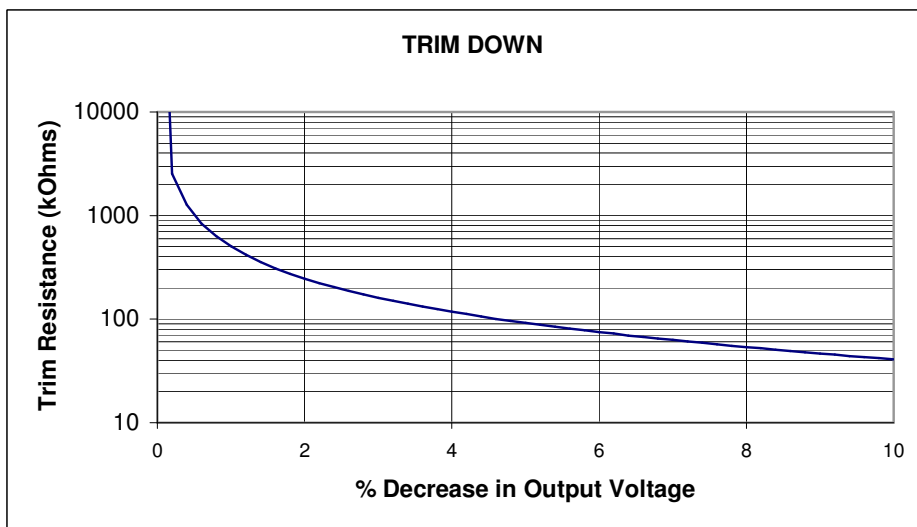

An external resistor connected between Trim and +Sense pins will increase the output voltage. For an increase of Δ% of the nominal output voltage, calculate the value of the external resistor using the following equation:

$$R_{\text{trim-up}} = \left(\frac{5.11 * 2.5 (100 + \Delta\%)}{1.225\Delta\%} - \frac{511}{\Delta\%} - 10.22 \right) K\Omega$$

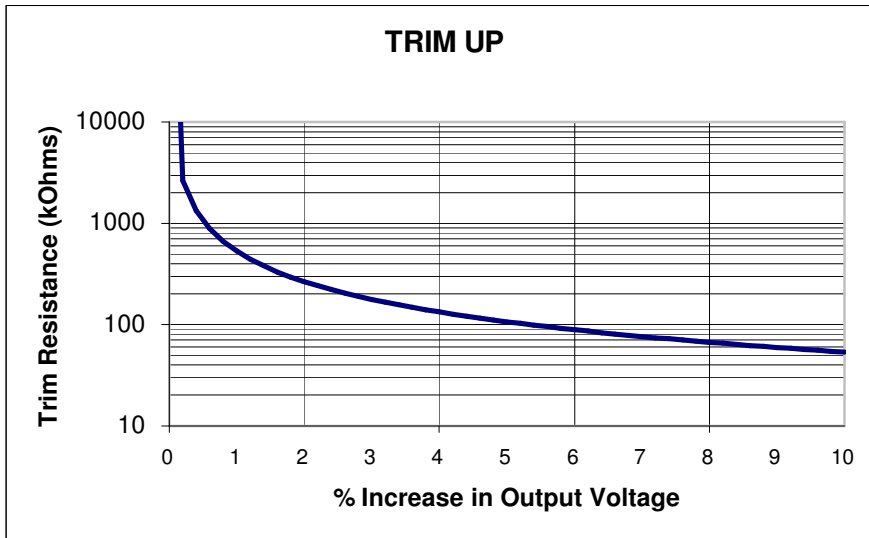

SENSE (+ or -)

The +Sense or –Sense pins must be connected to the load or output pins of the converter. To ensure tight regulation at the system critical load, then the remote sense pins should be connected to the system critical load. Reference applicable section of data sheet for maximum voltage compensation.

Ensure sufficient margin to the over voltage threshold, review applicable sections of the data sheet and system loading: output over-voltage protection –vs- system transient load condition(s).

THERMAL CONSIDERATIONS

The converter has internal thermal protection preventing hot spots on PCB from exceeding 120°C (248 °F), reference Figures 13 and 15. Margin to the temperature protection limit should be verified in the application. During an abnormal condition that induces an increase in the converter temperature, the converter output voltage will fold back when the over temperature protection threshold is reached. The converter will auto-recover when the fault condition is corrected and time allowed for the converter to cool down.

OVERCURRENT PROTECTION

The overcurrent limit inception is typically 110% of the rated output current. When the overcurrent limit inception is exceeded the output voltage will decrease proportional to increase to the load current. Further increase in the load current will cause the output voltage to trip the under voltage protection threshold and enter fault protection, or hiccup reference Figure 5. The converter will enter fault protection typically at 125% of rated output current. When the fault is removed the converter will auto recover.

Ordering code

AQ062W48V025V25AN

Option code -P for Positive Logic, example **AQ062W48V025V25AN-P**
-PL for Cold Plate, example **AQ062W48V025V25AN-PL**