

HS-1745

**Intel® Core™ 2 Duo/Core™ Duo/
Core™ Solo processor mITX Board**

- CompactFlash • Mini PCI •
- PCI-E/PCI Slot • DVI/CRT/LVDS • TV-Out •
- Dual GB LAN • Audio • SPDIF • SATA •
- ATA/33/66/100 • RS-232/422/485 •
- 6 COM • IrDA • USB2.0 • WDT • H/W Monitor •

Copyright Disclaimers

The accuracy of contents in this manual has passed thorough checking and review before publishing. BOSER Technology Co., Ltd., the manufacturer and publisher, is not liable for any infringements of patents or other rights resulting from its use. The manufacturer will not be responsible for any direct, indirect, special, incidental or consequential damages arising from the use of this product or documentation, even if advised of the possibility of such damage(s).

This manual is copyrighted and BOSER Technology Co., Ltd. reserves all documentation rights. Unauthorized reproduction, transmission, translation, and storage of any form and means (i.e., electronic, mechanical, photocopying, recording) of this document, in whole or partly, is prohibited, unless granted permission by BOSER Technology Co., Ltd.

BOSER Technology Co., Ltd. reserves the right to change or improve the contents of this document without due notice. BOSER Technology Co., Ltd. assumes no responsibility for any errors or omissions that may appear in this manual, nor does it make any commitment to update the information contained herein.

Trademarks

BOSER is a registered trademark of BOSER Technology Co., Ltd.

ISB is a registered trademark of BOSER Technology Co., Ltd.

Intel is a registered trademark of Intel Corporation.

Award is a registered trademark of Award Software, Inc.

AMI is a registered trademark of AMI Software, Inc.

All other trademarks, products and or product names mentioned herein are mentioned for identification purposes only, and may be trademarks and/or registered trademarks of their respective companies or owners.



***© Copyright 2008 BOSER Technology Co., Ltd.
All Rights Reserved.
Edition 1.5, May 15, 2009***

Table of Contents

Chapter 1	General Description	1
1.1	Major Features	2
1.2	Specifications	2
1.3	Board Dimensions	4
Chapter 2	Inpacking	5
2.1	Opening the Delivery Package	5
2.2	Inspection	5
Chapter 3	Hardware Installation	7
3.1	Before Installation	7
3.2	Board Layout	8
3.3	Jumper List	9
3.4	Connector List	10
3.5	Configuring the CPU	10
3.6	System Memory	11
3.7	VGA Controller	11
3.8	PCI E-IDE Drive Connector	13
3.9	Serial ATA Connector	14
3.10	Floppy Disk Drive Connector	15
3.11	Parallel Connector	16
3.12	Serial Port Connectors	16
3.13	Ethernet Connector	18
3.14	USB Connector	18
3.15	CMOS Data Clear	19
3.16	Power and Fan Connectors	19
3.17	Keyboard/Mouse Connectors	20
3.18	System Front Panel Control	20
3.19	IrDA Function	21
3.20	Watchdog Timer	21
3.21	TV-Out Function	22
3.22	Audio Connectors	23
3.23	CompactFlash™ Connector	23
3.24	Expansion Slot	25
3.25	8-bit I/O Function	25

Chapter 4	AMI BIOS Setup	29
4.1	Starting Setup	29
4.2	Using Setup	30
4.3	Main Menu	31
4.4	Advanced Settings	32
4.5	Advanced PCI/PnP Settings	38
4.6	Boot Settings	39
4.7	Security Settings	40
4.8	Advanced Chipset Settings	40
4.9	Exit Options	42
Chapter 5	Software Utilities	43
5.1	IDE Driver Installation	43
5.2	VGA Driver Installation	47
5.3	Audio Driver Installation	50
5.4	LAN Driver Installation	53

Declaration of Conformity -- CE Mark

BOSER Technology hereby acknowledges that compliance testing in accordance with applicable standards of the EU's EMC Directive, 89/336/EEC, was successfully completed on a sample of the equipment identified below:

Equipment Class:	<i>Information Technology Equipment</i>
Product Model Series:	<i>HS-1745</i>
This Product Complies With:	<i>EN55022: Class A for Radiated emissions</i>
	<i>EN50082-2: Heavy Industrial EMC Immunity</i>

We, the undersigned, hereby declare that the equipment specified above conforms to the above directives and standards.

Manufacturer:
BOSER TECHNOLOGY CO., LTD.

Safety Instructions

Integrated circuits on computer boards are sensitive to static electricity. To avoid damaging chips from electrostatic discharge, observe the following precautions:

- Do not remove boards or integrated circuits from their anti-static packaging until you are ready to install them.
- Before handling a board or integrated circuit, touch an unpainted portion of the system unit chassis for a few seconds. This helps to discharge any static electricity on your body.
- Wear a wrist-grounding strap, available from most electronic component stores, when handling boards and components. Fasten the ALLIGATOR clip of the strap to the end of the shielded wire lead from a grounded object. Please wear and connect the strap before handle the product to ensure harmlessly discharge any static electricity through the strap.
- Please use an anti-static pad when putting down any components or parts or tools outside the computer. You may also use an anti-static bag instead of the pad. Please inquire from your local supplier for additional assistance in finding the necessary anti-static gadgets.

NOTE: *DO NOT TOUCH THE BOARD OR ANY OTHER SENSITIVE COMPONENTS WITHOUT ALL NECESSARY ANTI-STATIC PROTECTIONS.*

Chapter 1

General Description



The HS-1745 is an Intel® 945GME GMCH chipset-based board designed. The HS-1745 is an ideal all-in-one mITX board. Additional features include an enhanced I/O with CF, DVI/CRT/LVDS, TV-Out, dual Giga LAN, audio, SPDIF, SATA, 6 COM, IrDA, and USB2.0 interfaces.

Designed with the Intel® 945GME GMCH, the board supports Intel® Core™ 2 Duo/Core™ Duo/Core™ Solo processor 1.66~2.33GHz.

Its onboard ATA/33/66/100 to IDE drive interface architecture allows the HS-1745 to support data transfers of 33, 66 or 100MB/sec. to one IDE drive connection. The Intel® ICH7-M serial ATA controller with two ports supporting transfer rates up to 150MB/sec.

Onboard Intel® 945GME GMCH for CRT display with DVMT or CHRONTEL 7307 for DVI display supporting up to 2048 x 1536. It also supports 18-bit single channel/36-bit dual channel LVDS interface.

System memory is also sufficient with the one SO-DDRII socket that can support up to 1GB. Additional onboard connectors include an advanced USB2.0 port providing faster data transmission. And two external RJ-45 connectors for 10/100 Based Ethernet use.

To ensure the reliability in an unmanned or standalone system, the watchdog timer (WDT) onboard HS-1745 is designed with software that does not need the arithmetical functions of a real-time clock chip. If any program causes unexpected halts to the system, the onboard WDT will automatically reset the CPU or generate an interrupt to resolve such condition.

1.1 Major Features

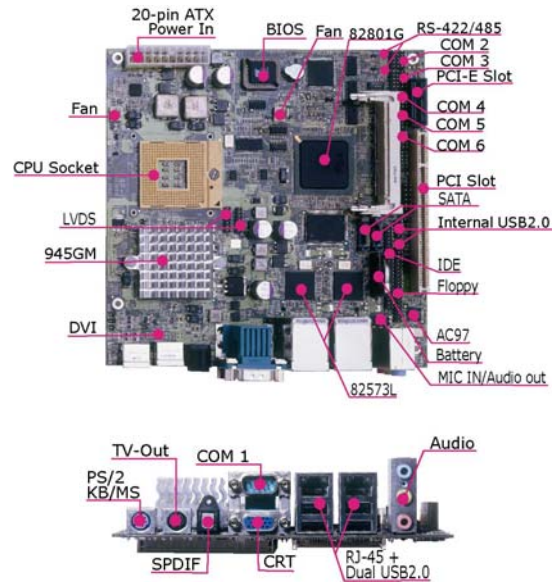

The HS-1745 comes with the following features:

- Intel® Core™ 2 Duo/Core™ Duo/Core™ Solo processor 1.66~2.33GHz
- One SO-DIMM up to 1GB DDR2 SDRAM
- Intel® 945GME/ICH7-M chipset, W83627EHG super I/O chipset
- Intel® 945GME or CHRONTEL 7307 DVI graphics, dual Intel® 82573L GB Ethernet, ALC202A audio Codec controller
- 18-bit single channel/36-bit dual channel LVDS panel display interface
- CF, SPDIF, SATA x 2, COM x 6, USB2.0 x 8, PClex1 slot, mini PCI slot, 3.3V PCI slot
- TV-Out, 8-bit I/O, H/W Monitor function

1.2 Specifications

System

- **CPU:**
Intel® Core™ 2 Duo/Core™ Duo/Core™ Solo processor 1.66~2.33GHz
Celeron® M: 410, 420, 430, 440, 450
Core™ Duo: T2300, T2400, T2500, T2600, T2700
Core™ 2 Duo: T5500, T5600, T7200, T7400, T7600
- **FSB:**
667/533MHz FSB
- **BIOS:**
AMI PnP Flash BIOS

- **System Chipset:**
Intel® 945GME GMCH/ICH7-M
- **I/O Chipset:**
Winbond W83627EHG
- **System Memory:**
1 x 200-pin SO-DIMM socket up to 1GB DDR2 SDRAM
- **Storage:**
1 x Type II CF socket
- **Watchdog Timer**
Software programmable time-out intervals from 1~255 sec.
- **H/W Status Monitor:**
Monitoring temperatures, voltages, and cooling fan status
- **Expansion:**
1 x PClex1 slot
1 x Type III mini PCI slot
1 x 3.3V PCI slot

I/O Interface

- **MIO:**
4 x RS-232
2 x RS-232/422/485
8 x USB2.0 (4 x internal, 4 x external)
1 x IDE
1 x FDD
1 x Parallel
2 x SATA
1 x PS/2 for KB/MS
1 x IrDA (only PCB v0.5 or above)
- **DI/O:**
8-bit input/output by parallel port

Display

- **Chipset:**
Intel® 945GME integrated Intel® GMA950
- **LVDS:**
18-bit single channel/36-bit dual channel
- **TV-Out:**
Provides PAL or NTSC TV systems
- **DVI:**
Chrontel 7307 (optional)

Audio

- **Chipset:**
RealTek ALC202A
- **Audio Interface:**
MIC In, Line Out, Line In, SPDIF

Ethernet

- **Chipset:**
Dual Intel® 82573L GB 10/100/1000 Mbps LAN
- **Ethernet Interface”**
RJ-45 x 2

Mechanical & Environmental

- **Operating Temperature:**
0~60 degrees C
- **Operating Humidity:**
0~95%, non-condensing
- **Size (L x W):**
170 x 170 mm

1.3 Board Dimensions

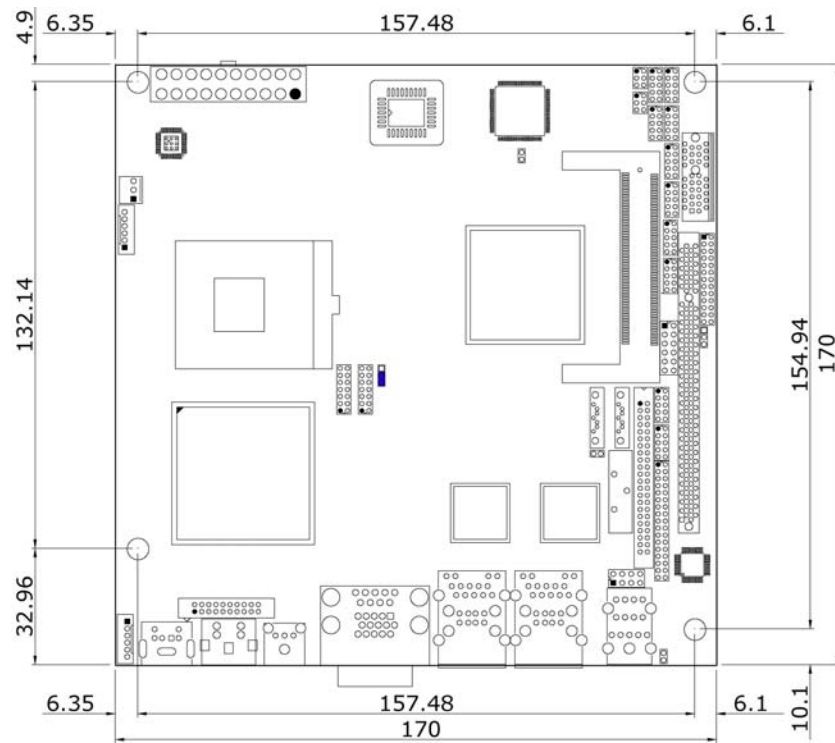

Chapter 2

Unpacking

2.1 Opening the Delivery Package

The HS-1745 is packed in an anti-static bag. The board has components that are easily damaged by static electricity. Do not remove the anti-static wrapping until proper precautions have been taken. Safety Instructions in front of this manual describe anti-static precautions and procedures.

2.2 Inspection

After unpacking the board, place it on a raised surface and carefully inspect the board for any damage that might have occurred during shipment. Ground the board and exercise extreme care to prevent damage to the board from static electricity.

Integrated circuits will sometimes come out of their sockets during shipment. Examine all integrated circuits, particularly the BIOS, processor, memory modules, ROM-Disk, and keyboard controller chip to ensure that they are firmly seated. The HS-1745 delivery package contains the following items:

- HS-1745 Board x 1
- Utility CD Disk x 1
- Cables Package x 1
- Jumper Bag x 1
- User's Manual



Cables Package		
NO.	Description	QTY.
1	COM DB9-10P (2.0-pitch)	1
2	Print DB25-26P(2.0-pitch)	1
3	1-to-2 Mini DIN cable	1
4	SATA device cable	1
5	34P(2.54)*3 FDC cable	1

It is recommended that you keep all the parts of the delivery package intact and store them in a safe/dry place for any unforeseen event requiring the return shipment of the product. In case you discover any missing and/or damaged items from the list of items, please contact your dealer immediately.

Option Accessories	
NO.	Description
1	1-to-2 USB cable with bracket
2	COM DB9-10P (2.0-pitch)
3	SATA power cable
4	Pentium® Cooler (251-10310002G)
5	40-pin to 44-pin IDE flat cable

Chapter 3

Hardware Installation

This chapter provides the information on how to install the hardware using the HS-1745. This chapter also contains information related to jumper settings of switch, and watchdog timer selection etc.

3.1 Before Installation

After confirming your package contents, you are now ready to install your hardware. The following are important reminders and steps to take before you begin with your installation process.

1. Make sure that all jumper settings match their default settings and CMOS setup correctly. Refer to the sections on this chapter for the default settings of each jumper. (Set JP6 open)
2. Go through the connections of all external devices and make sure that they are installed properly and configured correctly within the CMOS setup. Refer to the sections on this chapter for the detailed information on the connectors.
3. Keep the manual and diskette in good condition for future reference and use.

3.2 Board Layout

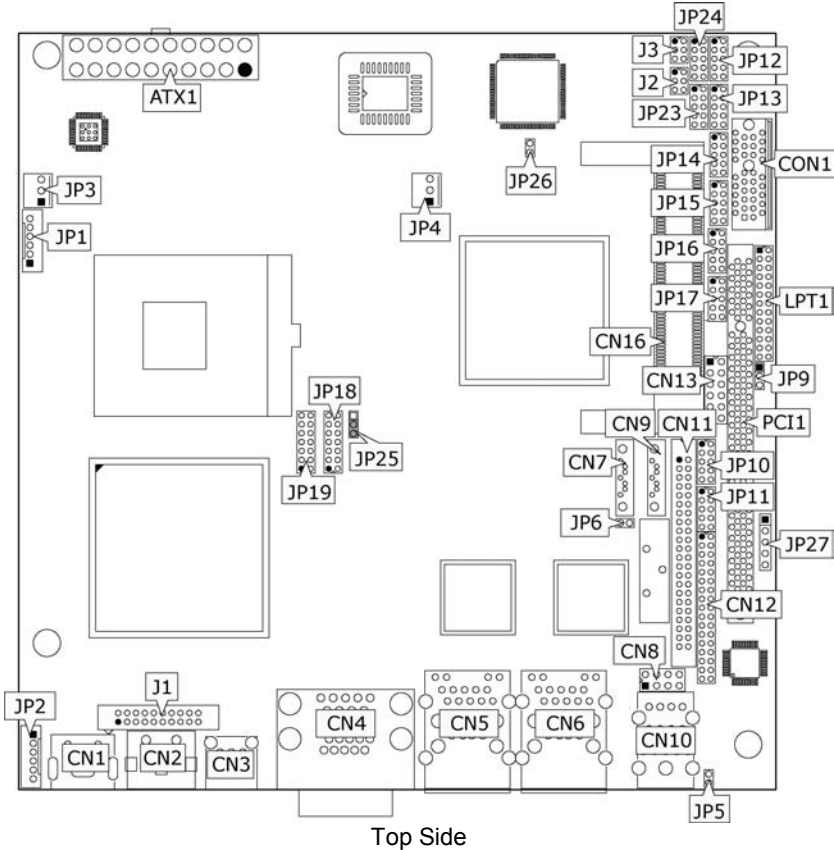

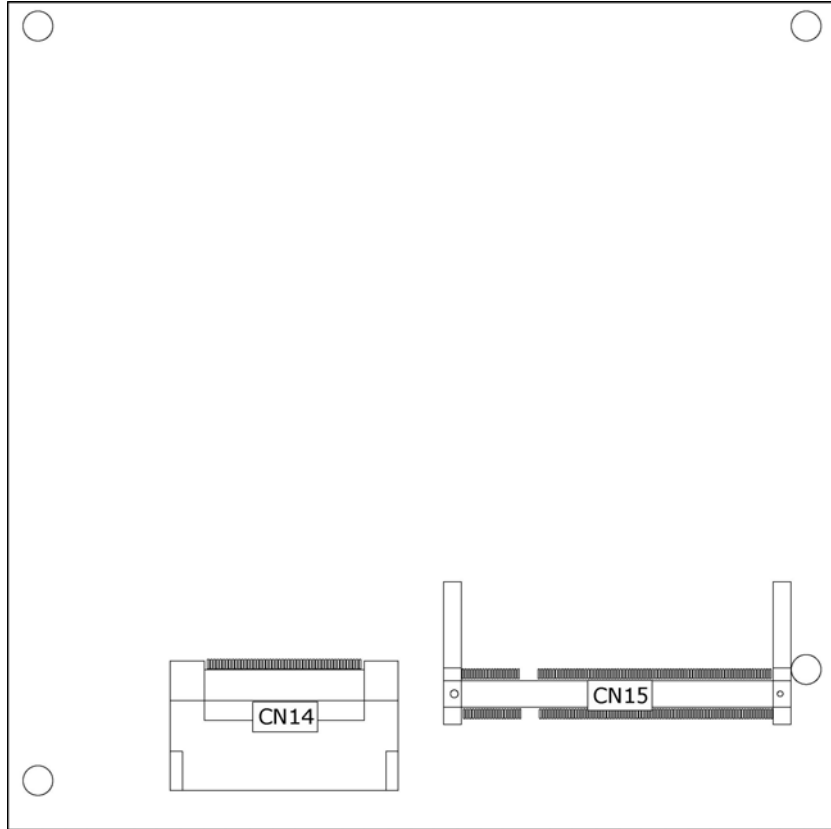

Solder Side

3.3 Jumper List

Jumper	Default Setting	Setting	Page
JP5	CF Use Master/Slave Select: <i>Slave</i>	Open	23
JP6	Clear CMOS: <i>Normal Operation</i>	Open	19
JP23	COM 3/COM 4 Use RS-232 or	Open	16
JP24	RS-422/485 Select: <i>RS-232</i>	Open	16
JP25	Panel Voltage Select: +3.3V	Short 2-3	11
JP26	FSB Frequency Select: <i>667MHz</i>	Open	10

3.4 Connector List

Connector	Definition	Page
ATX1	20-pin ATX Power In Connector	19
CN1	PS/2 6-pin Mini DIN KB/MS Connector	20
CN2	TV-Out Connector	22
CN3	SPDIF Connector	23
CN4	15-pin CRT Connector & COM 1 (DB9)	11/16
CN5/CN6	RJ-45 & Dual USB2.0 Port	18
CN7/CN9	Serial ATA Connector	14
CN8	MIC In/Line Out Connector	23
CN10	External Audio Connector	23
CN11	IDE Connector	13
CN12	Floppy Connector	15
CN13	System Front Panel Control	20
CN14	CompactFlash Connector	23
CN15	SO-DDRII Socket	11
CN16	Mini PCI Slot	25
JP1	Inverter Power In Connector	11
JP2	6-pin KB/MS Connector	20
JP3/JP4	Fan Power In Connector	19
JP9	Wake On LAN Connector	18
JP10/JP11	Internal USB2.0 Port	18
JP12~JP16	COM 2~COM 6 Connector (5x2 header)	16
JP17	8-bit I/O Port	25
JP18/JP19	LVDS Panel Connector	11
JP27	IrDA Connector	21
CON1	x1 PCI-E Slot	25
J1	DVI Connector	11
J2/J3	RS-422/485 Connector	16
LPT1	Parallel Port	16
PCI1	Standard PCI Slot	25

3.5 Configuring the CPU

The HS-1745 provides with Intel® Core™ 2 Duo/Core™ Duo/Core™ Solo processor 1.66~2.33GHz. User don't need to adjust the frequently and check speed of processor.

- **JP26: FSB Frequency Select**

Options	Settings
533MHz FSB	Short
667MHz FSB (default)	Open



3.6 System Memory

The HS-1745 provides one SO-DDRII socket at locations *CN15*. The maximum capacity of the onboard memory is 1GB.

3.7 VGA Controller

The HS-1745 provides two connection methods of a VGA device. *CN4A* offers a single standard CRT connector and *JP18/JP19* are the LVDS interface connectors onboard reserved for flat panel installation.

- **CN4A: CRT Connector**

PIN	Description	PIN	Description
1	Red	2	Green
3	Blue	4	N/C
5	GND	6	GND
7	GND	8	GND
9	N/C	10	GND
11	N/C	12	SDA
13	HSYNC	14	VSYNC
15	SCL		

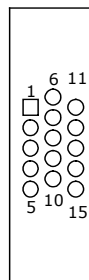

- **JP18/JP19: LVDS Interface Connector**

PIN	Description	PIN	Description
1	V _{LCD}	2	V _{LCD}
3	GND	4	GND
5	Y0-/Z0-	6	Y0+/Z0+
7	Y1-/Z1-	8	Y1+/Z1+
9	Y2-/Z2-	10	Y2+/Z2+
11	CLK-	12	CLK+
13	N/C	14	N/C

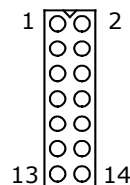

NOTE: LVDS cable should be produced very carefully. Y0- & Y0+ have to be fabricated in twister pair (Y1- & Y1+, Y2- & Y2+ and so on) otherwise the signal won't be stable. Please set the proper voltage of your panel using JP25 before proceeding on installing it.

NOTE: If use JP18 only, it just supports 16-bit single channel LVDS panel; If you want to use 36-bit dual channel LVDS panel, please use JP18 and JP19 combined.

● **JP25: Panel Voltage Select**

Options	Settings
+5V	Short 1-2
+3.3V (default)	Short 2-3



● **JP1: Inverter Power In Connector**

PIN	Description
1	+12V
2	+12V
3	+5V
4	+5V
5	VDDEN
6	GND



● **J1: DVI Connector**

PIN	Description	PIN	Description
1	TDC0#	2	+5V
3	TDC0	4	GND
5	GND	6	DETET
7	TDC1#	8	SC_DDC
9	TDC1	10	SD_DDC
11	GND	12	GND
13	TDC2#	14	TLC#
15	TDC2	16	TLC
17	GND	18	GND
19	N/C	20	N/C

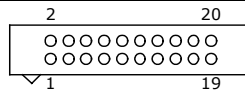

3.8 PCI E-IDE Drive Connector

CN11 is a standard 44-pin 2.0-pitch connector daisy-chain driver connector serves the PCI E-IDE drive provisions onboard the HS-1745. A maximum of two ATA/33/66/100 IDE drives can be connected to the HS-1745 via CN11.

- **CN11: IDE Connector**

PIN	Description	PIN	Description
1	IDERST	2	GND
3	PDD7	4	PDD8
5	PDD6	6	PDD9
7	PDD5	8	PDD10
9	PDD4	10	PDD11
11	PDD3	12	PDD12
13	PDD2	14	PDD13
15	PDD1	16	PDD14
17	PDD0	18	PDD15
19	GND	20	N/C
21	PDDREQ	22	GND
23	IOW#	24	GND
25	IOR#	26	GND
27	PIORDY	28	470Ω with GND
29	PDDACK#	30	GND
31	IRQ14	32	N/C
33	PDA1	34	PD33/66
35	PDA0	36	PDA2
37	PDCS1#	38	PDCS3#
39	HDD Active	40	GND
41	VCC	42	VCC
43	GND	44	N/C

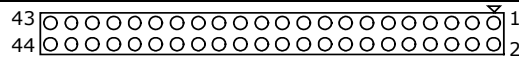

3.9 Serial ATA Connector

You can connect the Serial ATA device that provides you high speeds transfer rates (150MB/sec.). If you wish to use RAID function, please note that these two serial ATA connectors just support RAID0 and only compatible with WIN XP.

- **CN7/CN9: Serial ATA Connector**

PIN	Description
1	GND
2	SATATXP
3	SATATXN
4	GND
5	SATARXN
6	SATARXP
7	GND

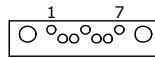

3.10 Floppy Disk Drive Connector

The HS-1745 uses a standard 34-pin header connector, *CN12*, for floppy disk drive connection. A total of two FDD drives may be connected to *CN12* at any given time.

- **CN12: Floppy Connector**

PIN	Description	PIN	Description
1	GND	2	DRVDEN0
3	GND	4	N/C
5	GND	6	DRVDEN1
7	GND	8	INDEX#
9	GND	10	MTR0#
11	GND	12	DS1#
13	GND	14	DS0#
15	GND	16	MTR1#
17	GND	18	DIR#
19	GND	20	STEP#
21	GND	22	WDATA#
23	GND	24	WGATE#
25	GND	26	TRAK00#
27	GND	28	WRTPRT#
29	GND	30	RDATA#
31	GND	32	HDSEL#
33	GND	34	DSKCHG#

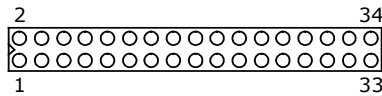

3.11 Parallel Connector

LTP1 is a standard 26-pin flat cable connector designed to accommodate parallel port connection on the HS-1745.

NOTE: If you want to use parallel port, 8-bit I/O function will be disabled.

- **LPT1: Parallel Connector**

PIN	Description	PIN	Description
1	Strobe	14	Auto Form Feed
2	DATA 0	15	ERROR#
3	DATA 1	16	Initialize
4	DATA 2	17	Printer Select LN#
5	DATA 3	18	GND
6	DATA 4	19	GND
7	DATA 5	20	GND
8	DATA 6	21	GND
9	DATA 7	22	GND
10	Acknowledge	23	GND
11	Busy	24	GND
12	Paper Empty	25	GND
13	Printer Select	26	GND

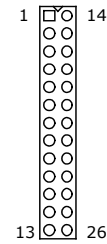

3.12 Serial Port Connectors

The HS-1745 offers NS16C550 compatible UARTs with Read/Receive 16-byte FIFO serial ports and five internal 10-pin headers and two RS-422/485 connectors.

- **CN4A: COM 1 Connector (DB9)**

PIN	Description	PIN	Description
1	DCD	2	DSR
3	RXD	4	RTS
5	TXD	6	CTS
7	DTR	8	RI
9	GND		

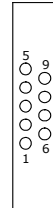

● JP12~JP16: COM 2~COM 6 Connector (5x2 Header)

PIN	Description	PIN	Description
1	DCD	2	DSR
3	RXD	4	RTS
5	TXD	6	CTS
7	DTR	8	RI
9	GND	10	+12V



● J2/J3: RS-422/485 Connector (3x2 Header, COM 3/COM 4)

PIN	Description	PIN	Description
1	TX-	2	TX+
3	RX+	4	RX-
5	GND	6	+5V



NOTE: The terminal resistance of RX & TX is set at $180\ \Omega$.

● JP23/JP24: COM 3/COM 4 use RS-232 or RS-422/485 Select

Options	Settings
RS-232 (default)	Open
RS-485 by Auto (*1)	Short 1-2, 3-4, 5-7, 8-10
RS-485 by -RTS (*-1)	Short 1-2, 3-4, 7-9, 8-10
RS-422/485 Full Duplex (*2)	Short 1-2, 3-4, 6-8



NOTE: *1: 2-wires RS-485 function

*2: 4-wires point-to-point full duplex function

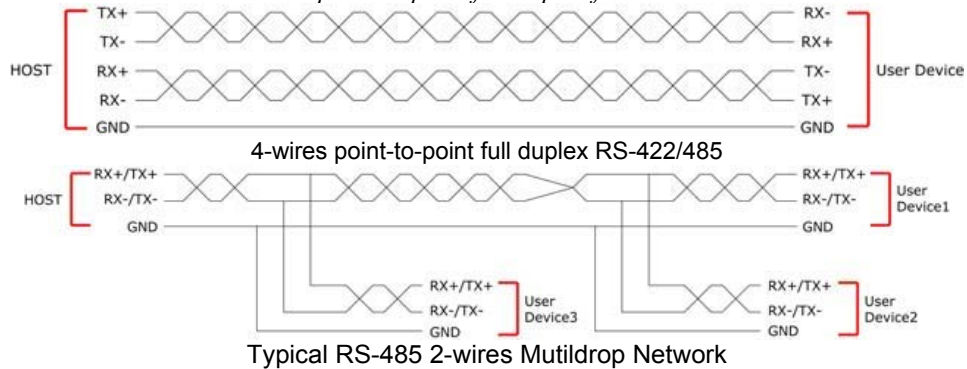

3.13 Ethernet Connector

The HS-1745 provides two external RJ-45 interface connectors. Please refer to the following for its pin information.

- **CN5A/CN6A: RJ-45 Connector**

PIN	Description
1	TX+
2	TX-
3	RX+
4	R/C GND
5	R/C GND
6	RX-
7	R/C GND
8	R/C GND

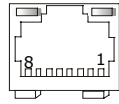

- **JP9: Wake On LAN**

PIN	Description
1	+5V
2	GND
3	Wake On LAN



3.14 USB Connector

The HS-1745 provides two 8-pin connectors, at location *JP10/JP11*, for four USB ports, and four external USB2.0 ports at *CN5B/CN6B*.

- **CN5B/CN6B: External USB2.0 Connector**

PIN	Description	PIN	Description
1	VCC	2	VCC
3	USBD0-/USB2-	4	USBD1-/USB3-
5	USBD0+/USB2+	6	USBD1+/USB3+
7	GND	8	GND

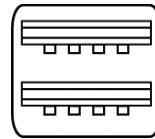

- **JP10/JP11: Internal USB2.0 Connector**

PIN	Description	PIN	Description
1	VCC	2	VCC
3	USBD4-/USBD6-	4	USBD5-/ USBD7-
5	USBD4+/USBD6+	6	USBD5+/ USBD7+
7	GND	8	GND



3.15 CMOS Data Clear

The HS-1745 has a Clear CMOS jumper on *JP6*.

- **JP6: Clear CMOS**

Options	Settings
Normal Operation (default)	Open
Clear CMOS	Short



IMPORTANT: Before you turn on the power of your system, please set *JP6* to Open for normal operation.

3.16 Power and Fan Connectors

HS-1745 provides one 20-pin ATX power in at *ATX1*.

- **ATX1: 20-pin ATX Power In Connector**

PIN	Description	PIN	Description
1	+3.3V	11	+3.3V
2	+3.3V	12	-12V
3	GND	13	GND
4	+5V	14	PS_ON
5	GND	15	GND
6	+5V	16	GND
7	GND	17	GND
8	Power OK	18	-5V
9	5VSB	19	+5V
10	+12V	20	+5V

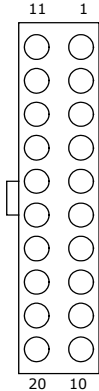

- **JP3/JP4: Fan Power In Connector**

PIN	Description
1	GND
2	+12V
3	Fan In 1/Fan In 2



Connector *JP3/JP4* onboard HS-1745 is a 3-pin fan power output connector. And HS-1745 supports +12V Fan only.

3.17 Keyboard/Mouse Connectors

The HS-1745 offers two possibilities for keyboard/mouse connections. The connections are via *CN1* for an external PS/2 type keyboard/mouse or via *JP2* for an internal 6-pin cable converter to a keyboard/mouse.

- **CN1: PS/2 6-pin Mini DIN Keyboard/Mouse Connector**

PIN	Description
1	Keyboard Data
2	Mouse Data
3	GND
4	+5V
5	Keyboard Clock
6	Mouse Clock

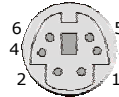

- **JP2: 6-pin Keyboard/Mouse Connector**

PIN	Description
1	Keyboard Data
2	Mouse Data
3	GND
4	+5V
5	Keyboard Clock
6	Mouse Clock



3.18 System Front Panel Control

The HS-1745 has front panel control at location *CN13* that indicates the power-on status.

- **CN13: System Front Panel Control**

PIN	Description	PIN	Description
1	VCC	2	Speaker
3	HDD LED	4	N/C
5	PWR Button	6	GND
7	VCC	8	GND
9	Reset Switch	10	VCC
11	GND	12	PWR LED

Connector CN13 Orientation

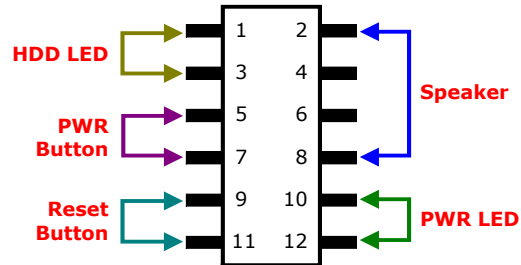

3.19 IrDA Function

JP27 is a 5-pin internal IR communication connector for connection of an IrDA device.

- **JP27: IrDA Connector**

PIN	Description
1	VCC
2	N/C
3	IRRX
4	GND
5	IRTX

3.20 Watchdog Timer

Once the Enable cycle is active a Refresh cycle is requested before the time-out period. This restarts counting of the WDT period. When the time counting goes over the period preset of WDT, it will assume that the program operation is abnormal. A system reset signal will restart when such error happens.

The following sample programs show how to enable, disable and refresh the watchdog timer:

```

;-----
;Enter the WDT function mode, interruptible double-write
;-----
MOV    DX, 2EH
MOV    AL, 87H
OUT    DX, AL
OUT    DX, AL
MOV    DX, 2EH
MOV    AL, 07H
OUT    DX, AL
MOV    DX, 2FH

```

```

MOV     AL, 08H
OUT     DX, AL
MOV     DX, 2EH
MOV     AL, F5H
OUT     DX, AL           ;select CRF0
MOV     DX, 2FH
MOV     AL, 80H
OUT     DX, AL
MOV     DX, 2EH
MOV     AL, F7H
OUT     DX, AL
MOV     DX, 2FH

MOV     AL, 00H
OUT     DX, AL
MOV     DX, 2EH
MOV     AL, F6H
OUT     DX, AL
MOV     DX, 2FH
MOV     AL, 00H           ; *00H=Disabled
OUT     DX, AL
;-----
;Exit extended function mode
;-----
MOV     DX, 2EH
MOV     AL, AAH
OUT     DX, AL

```

User can also use AL, 00H's defined time for reset purposes, e.g.00H for Disable, 01H = 1sec, 02H=2sec....FFH=255sec.

3.21 TV-Out Function

The HS-1745 can support TV-out function whose input could be up to 800 x 600 graphics resolutions. World Wide Video standards are supported including NTSC-M (North America, Taiwan), NTSC-J (Japan), PAL-b, D, G, H, I (Europe, Asia), PAL-M (Brazil), PAL-N (Uruguay, Paraguay) and PAL-NC (Argentina).

- **CN2: TV-Out Connector**

PIN	Description	PIN	Description
1	GND	2	GND
3	DACB OUT	4	GND
5	DACC OUT	6	GND
7	GND		

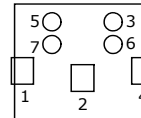

3.22 Audio Connectors

The HS-1745 has an onboard AC97 3D audio controller. The following tables list the pin assignments of the Line In/Audio Out connector.

- **CN3: SPDIF Connector**

PIN	Description
1	GND
2	VCC
3	SPDIF

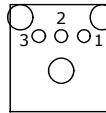

- **CN8: MIC In/Line Out Connector**

PIN	Description	PIN	Description
1	AOUTL	2	AOUTR
3	GND	4	GND
5	MIC IN	6	N/C
7	GND	8	GND



- **CN10: External Audio Connector**

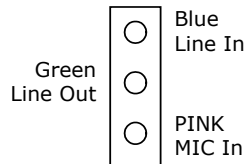

3.23 CompactFlash™ Connector

The HS-1745 also offers a Type I/II CompactFlash™ connector which is IDE interface located at the solder side of the board. The designated CN14 connector, once soldered with an adapter, can hold CompactFlash™ cards of various sizes. Please turn off the power before inserting the CF card.

- **CN14: CompactFlash™ Connector**

PIN	Description	PIN	Description
1	GND	2	IDE_PDD3
3	IDE_PDD4	4	IDE_PDD5
5	IDE_PDD6	6	IDE_PDD7
7	IDE_PDCS1#	8	GND

...MORE ON NEXT PAGE...

PIN	Description	PIN	Description
9	GND	10	GND
11	GND	12	GND
13	+3.3V	14	GND
15	GND	16	GND
17	GND	18	IDE_PDA2
19	IDE_PDA1	20	IDE_PDA0
21	IDE_PDD0	22	IDE_PDD1
23	IDE_PDD2	24	GND
25	GND	26	GND
27	IDE_PDD11	28	IDE_PDD12
29	IDE_PDD13	30	IDE_PDD14
31	IDE_PDD15	32	IDE_PDCS3#
33	GND	34	IDE_PDIO#
35	IDE_PDIOW#	36	+3.3V
37	INT_IRQ15	38	+3.3V
39	+3.3V	40	N/C
41	RESET#	42	IDE_PDIORDY
43	CF_PDERQ	44	CF_REGB
45	IDE_ACTP#	46	DETECT
47	IDE_PDD8	48	IDE_PDD9
49	IDE_PDD10	50	GND

Inserting a CompactFlash™ card into the adapter is not a difficult task. The socket and card are both keyed and there is only one direction for the card to be completely inserted. Refer to the diagram on the following page for the traditional way of inserting the card.

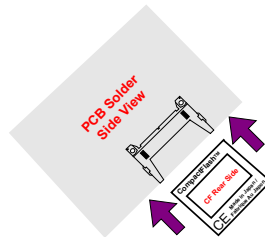

● **JP5: CF Use Master/Slave Select**

Options	Setting
Master	Short
Slave(default)	Open



NOTE: When use CF card, IDE device function will be disabled.

3.24 Expansion Slot

The HS-1745 offers one Type III mini PCI slot at *CN16*, one x1 PCI-E slot at *CON1*, one standard PCI slot at *PCI1*.

3.25 8-bit I/O Function

The HS-1745 offers one 8-bit input/output port by parallel port.

NOTE: *If you want to use 8-bit I/O, parallel port function will be disabled.*

- **JP17: 8-bit Input/Output**

PIN	Description	PIN	Description
1	VCC	2	GND
3	GD0	4	GD4
5	GD1	6	GD5
7	GD2	8	GD6
9	GD3	10	GD7

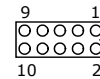

.286

```

.MODEL SMALL
.DATA
port equ 0378h ;this is data area
;print port can be change to 278h

.CODE

print macro buff
mov dx, offset buff;
mov ah,09h
int 21h
endm

delay :
push cx
mov cx,0155h

@@:
jmp $+2
push cx
mov cx,0ffffh

wait1: loop wait1
pop cx
loop @b
pop cx
ret

begin proc near
mov ax,@data
mov ds,ax
STI

```

```

        Mov     dx, port
        Mov     al, 80h           out     dx, al
;;-----
;;ROR
@@:     mov     cx, 08h
        ror     al, 1
        call   delay
        out    dx, al
        loop   @b
        pop    cx
;;ROL
        push   cx
        mov    cx, 08h
@@:     rol     al, 1
        out    dx, al
        call   delay
        loop   @b
        pop    cx
;;-----
;;-----
;;ROR
@@:     mov     cx, 08h
        ror     al, 1
        call   delay
        out    dx, al
        loop   @b
        pop    cx
;;ROL
        push   cx
        mov    cx, 08h
@@:     rol     al, 1
        out    dx, al
        call   delay
        loop   @b
        pop    cx
;;-----
;;-----
;;ROR
@@:     mov     cx, 08h
        ror     al, 1
        call   delay
        out    dx, al
        loop   @b
        pop    cx
;;ROL
        push   cx
        mov    cx, 08h
@@:     rol     al, 1
        out    dx, al
        call   delay
        loop   @b

```



```

        pop     cx
;;-----
;;-----
;;ROR
        mov     cx, 08h
@@:
        ror     al, 1
        call delay
        out     dx, al
        loop   @b
        pop     cx
;;ROL
        push    cx
        mov     cx, 08h
@@:
        rol     al, 1
        out     dx, al
        call delay
        loop   @b
        pop     cx
;;-----
;;-----
;;ROR
        mov     cx, 08h
@@:
        ror     al, 1
        call delay
        out     dx, al
        loop   @b
        pop     cx
;;ROL
        push    cx
        mov     cx, 08h
@@:
        rol     al, 1
        out     dx, al
        call delay
        loop   @b
        pop     cx
;;-----
;;-----
;;ROR
        mov     cx, 08h
@@:
        ror     al, 1
        call delay
        out     dx, al
        loop   @b
        pop     cx
;;ROL
        push    cx
        mov     cx, 08h
@@:
        rol     al, 1
        out     dx, al
        call delay
        loop   @b
        pop     cx

```

```

;;-----
;;-----
;;ROR
    mov     cx, 08h
@@:   ror     al, 1
      call delay
      out    dx, al
      loop  @b
      pop   cx
;;ROL
    push   cx
    mov    cx, 08h
@@:   rol     al, 1
      out    dx, al
      call delay
      loop  @b
      pop   cx
;;-----
;flash LED 3 time
    mov    cx, 01h
@@:   mov    al, 0ffh
      out    dx, al
      call delay
      mov    al, 0h
      out    dx, al
      call delay
      loop  @b
ee:

    mov    ah, 4ch          ;go back to dos
    int    21h
    .stack
    begin  endp
    end begin

```

Chapter 4

AMI BIOS Setup

The HS-1745 uses AMI BIOS for the system configuration. The AMI BIOS setup program is designed to provide the maximum flexibility in configuring the system by offering various options that could be selected for end-user requirements. This chapter is written to assist you in the proper usage of these features.

4.1 Starting Setup

The AMI BIOS is immediately activated when you first power on the computer. The BIOS reads the system information contained in the CMOS and begins the process of checking out the system and configuring it. When it finishes, the BIOS will seek an operating system on one of the disks and then launch and turn control over to the operating system.

While the BIOS is in control, the Setup program can be activated in one of two ways:

1. By pressing immediately after switching the system on, or
2. By pressing the key when the following message appears briefly at the bottom of the screen during the POST (Power On Self Test).

Press DEL to enter SETUP.

If the message disappears before you respond and you still wish to enter Setup, restart the system to try again by turning it OFF then ON or pressing the "RESET" button on the system case. You may also restart by simultaneously pressing <Ctrl>, <Alt>, and <Delete> keys. If you do not press the keys at the correct time and the system does not boot, an error message will be displayed and you will be asked to...

PRESS F1 TO CONTINUE, DEL TO ENTER SETUP

4.2 Using Setup

In general, you use the arrow keys to highlight items, press <Enter> to select, use the <PageUp> and <PageDown> keys to change entries, and press <Esc> to quit. The following table provides more detail about how to navigate in the Setup program using the keyboard.

↑	Move to previous item
↓	Move to next item
←	Move to previous item
→	Move to previous item
Esc key	Main Menu -- Quit and not save changes into CMOS Status Page Setup Menu and Option Page Setup Menu -- Exit current page and return to Main Menu
PgUp key	Decrease the numeric value or make changes
PgDn key	Increase the numeric value or make changes
+ key	Increase the numeric value or make changes
- key	Decrease the numeric value or make changes
F1 key	Reserved
F2 key	Change color from total 8 colors. F2 to select color forward
F3 key	F2 to select color backward
F4 key	Reserved
F5 key	Reserved
F6 key	Reserved
F7 key	Reserved
F8 key	Reserved
F9 key	Reserved
F10 key	Save all the CMOS changes, only for Main Menu

4.3 Main Menu

Once you enter the AMI BIOS CMOS Setup Utility, the Main Menu will appear on the screen. The Main Menu allows you to select from several setup functions and two exit choices. Use the arrow keys to select among the items and press <Enter> to enter the sub-menu.

BIOS SETUP UTILITY						
Main	Advanced	PCIPnP	Boot	Security	Chipset	Exit
System Overview						
AMIBIOS						
Version : 08.00.13						
Build Date : 11/01/06						
ID : HS174500						
Processor						
Type : Intel® Core™ Duo CPU T2700						
Speed : 2333MHz						
Count : 1						
System Memory						
Size : 504MB						
System Time [00:29:32]						
System Date [Tue 01/01/2002]						
						← Select Screen
						↑ ↓ Select Item
						+ - Change Field
						Tab Select Field
						F1 General Help
						F10 Save and Exit
						ESC Exit
v02.59 (C)Copyright 1985-2005, American Megatrends, Inc.						

NOTE: *A brief description of the highlighted choice appears at the bottom of the screen.*

4.4 Advanced Settings

This section allows you to configure your system for the basic operation. You have the opportunity to select the system's default speed, boot-up sequence, keyboard operation, shadowing and security.

Main	Advanced	PCIPnP	Boot	Security	Chipset	Exit
BIOS SETUP UTILITY						
Advanced Settings						
WARNING: Setting wrong values in below sections may cause system to malfunction.						
<ul style="list-style-type: none"> ▶ CPU Configuration ▶ IDE Configuration ▶ Floppy Configuration ▶ SuperIO Configuration ▶ Hardware Health Configuration ▶ ACPI Configuration ▶ APM Configuration ▶ USB Configuration 					← Select Screen ↑ ↓ Select Item + - Change Field Tab Select Field F1 General Help F10 Save and Exit ESC Exit	
v02.59 (C)Copyright 1985-2005, American Megatrends, Inc.						

Main	Advanced	PCIPnP	Boot	Security	Chipset	Exit
BIOS SETUP UTILITY						
Configure advanced CPU settings						
Module Version -13.03						
Manufacturer : Intel						
Brand String : Intel® Core™ Duo CPU T2700						
Frequency : 2.33GHz						
FSB Speed : 667MHz						
Cache L1 : 64 KB						
Cache L2 : 2048 KB						
Max CPUID Value Limit [Disabled]						
Execute Disable Bit [Enabled]					← Select Screen	
Core Multi-Processing [Enabled]					↑ ↓ Select Item	
CPU TM function [Enabled]					+ - Change Field	
Venderpool Technology [Enabled]					Tab Select Field	
Digital Thremal Sensor [Disabled]					F1 General Help	
DTS Calibration [Enabled]					F10 Save and Exit	
Intel® SpeedStep™ tech. [Automatic]					ESC Exit	
v02.59 (C)Copyright 1985-2005, American Megatrends, Inc.						

BIOS SETUP UTILITY

Main	Advanced	PCIPnP	Boot	Security	Chipset	Exit
IDE Configuration						
ATA/IDE Configuration		[Compatible]				
Legacy IDE Channels		[SATA Pri, PATA Sec]				
▶ Primary IDE Master		: [Not Detected]				
▶ Primary IDE Slave		: [Not Detected]				
▶ Secondary IDE Master		: [Not Detected]				
▶ Secondary IDE Slave		: [Not Detected]				
Hard Disk Write Protect		[Disabled]				← Select Screen
IDE Detect Time Out (Sec)		[35]				↑ ↓ Select Item
ATA(PI) 80Pin Cable Detection		[Host]				+ - Change Field
						Tab Select Field
						F1 General Help
						F10 Save and Exit
						ESC Exit
v02.59 (C)Copyright 1985-2005, American Megatrends, Inc.						

BIOS SETUP UTILITY

Main	Advanced	PCIPnP	Boot	Security	Chipset	Exit
Floppy Configuration						
Floppy A		[1.44 MB 3.5"]				
Floppy B		[Disabled]				
						← Select Screen
						↑ ↓ Select Item
						+ - Change Field
						Tab Select Field
						F1 General Help
						F10 Save and Exit
						ESC Exit
v02.59 (C)Copyright 1985-2005, American Megatrends, Inc.						

BIOS SETUP UTILITY

Main	Advanced	PCIPnP	Boot	Security	Chipset	Exit
Configure WIN627EHF Super IO Chipset						
OnBoard Floppy Controller			[Enabled]			
Serial PortA Address			[3F8]			
Serial PortA IRQ			[3]			
Serial PortB Address			[2F8]			
Serial PortB IRQ			[4]			
Serial PortC Address			[3E8]			
Serial PortC IRQ			[10]			
Serial PortD Address			[2E8]			
Serial PortD IRQ			[11]		← Select Screen	
Serial PortE Address			[2F0]		↑ ↓ Select Item	
Serial PortE IRQ			[10]		+ - Change Field	
Serial PortF Address			[2E0]		Tab Select Field	
Serial PortF IRQ			[11]		F1 General Help	
					F10 Save and Exit	
					ESC Exit	
v02.59 (C)Copyright 1985-2005, American Megatrends, Inc.						

BIOS SETUP UTILITY

Main	Advanced	PCIPnP	Boot	Security	Chipset	Exit
Hardware Health Configuration						
Hardware Health Configuration						
System Temperature			:			
CPU Temperature			:			
Vcore			:			
3VCC			:		← Select Screen	
+12V			:		↑ ↓ Select Item	
+1.5V			:		+ - Change Field	
+1.05V			:		Tab Select Field	
+5V			:		F1 General Help	
VBAT			:		F10 Save and Exit	
					ESC Exit	
v02.59 (C)Copyright 1985-2005, American Megatrends, Inc.						

BIOS SETUP UTILITY

Main	Advanced	PCIPnP	Boot	Security	Chipset	Exit
ACPI Settings						
ACPI Aware O/S				[Yes]		
<ul style="list-style-type: none"> ▶ General ACPI Configuration ▶ Advanced ACPI Configuration ▶ Chipset ACPI Configuration 				← Select Screen ↑ ↓ Select Item + - Change Field Tab Select Field F1 General Help F10 Save and Exit ESC Exit		
v02.59 (C)Copyright 1985-2005, American Megatrends, Inc.						

BIOS SETUP UTILITY

Main	Advanced	PCIPnP	Boot	Security	Chipset	Exit
General ACPI Configuration						
Suspend mode				[S1 (POS)]		
				← Select Screen ↑ ↓ Select Item + - Change Field Tab Select Field F1 General Help F10 Save and Exit ESC Exit		
v02.59 (C)Copyright 1985-2005, American Megatrends, Inc.						

BIOS SETUP UTILITY

Main	Advanced	PCIPnP	Boot	Security	Chipset	Exit
Advanced ACPI Configuration						
ACPI Version Features				[ACPI v1.0]		
ACPI APIC support				[Enabled]		
AMI OEMB table				[Enabled]		
Headless mode				[Disabled]		
				← Select Screen ↑ ↓ Select Item + - Change Field Tab Select Field F1 General Help F10 Save and Exit ESC Exit		
v02.59 (C)Copyright 1985-2005, American Megatrends, Inc.						

BIOS SETUP UTILITY

Main	Advanced	PCIPnP	Boot	Security	Chipset	Exit
USB Configuration						
Module Version - 2.24.0-11.4						
USB Devices Enabled: None						
Legacy USB Support				[Enabled]		
Hotplug USB FDD Support				[Auto]		
▶ USB Mass Storage Device Configuration						
						← Select Screen
						↑ ↓ Select Item
						+ - Change Field
						Tab Select Field
						F1 General Help
						F10 Save and Exit
						ESC Exit
v02.59 (C)Copyright 1985-2005, American Megatrends, Inc.						

BIOS SETUP UTILITY

Main	Advanced	PCIPnP	Boot	Security	Chipset	Exit
USB Mass Storage Device Configuration						
USB Mass Storage Reset Delay				[20 Sec]		
Device #1		USB Hotplug FDD				
Emulation Type		[Auto]				
						← Select Screen
						↑ ↓ Select Item
						+ - Change Field
						Tab Select Field
						F1 General Help
						F10 Save and Exit
						ESC Exit
v02.59 (C)Copyright 1985-2005, American Megatrends, Inc.						

BIOS SETUP UTILITY

Main	Advanced	PCIPnP	Boot	Security	Chipset	Exit
		Power Management/APM	[Enabled]			
		Video Power Down Mode	[Disabled]			
		Hard Disk Power Down Mode	[Disabled]			
		Suspend Time Out	[Disabled]			
		Throttle Slow Clock Ratio	[50%]			
		Keyboard & PS/2 Mouse	[MONITOR]			
		Power Button Mode	[On/Off]			
		Advanced Resume Events Controls				
		Resume On Ring	[Disabled]			
		Resume On LAN	[Disabled]			
		Resume On PME#	[Disabled]			
		Resume On RTC Alarm	[Disabled]			
				←	Select Screen	
				↑ ↓	Select Item	
				+ -	Change Field	
				Tab	Select Field	
				F1	General Help	
				F10	Save and Exit	
				ESC	Exit	
v02.59 (C) Copyright 1985-2005, American Megatrends, Inc.						

BIOS SETUP UTILITY

Main	Advanced	PCIPnP	Boot	Security	Chipset	Exit
		South Bridge ACPI Configuration				
		Energy Lake Feature	[Disabled]			
		APCI ACPI SCI IRQ	[Disabled]			
		USB Device Wakeup From S3/S4	[Disabled]			
				←	Select Screen	
				↑ ↓	Select Item	
				+ -	Change Field	
				Tab	Select Field	
				F1	General Help	
				F10	Save and Exit	
				ESC	Exit	
v02.59 (C) Copyright 1985-2005, American Megatrends, Inc.						

4.5 Advanced PCI/PnP Settings

This section describes configuring the PCI bus system. PCI, or Personal Computer Interconnect, is a system that allows I/O devices to operate at speeds nearing the speed the CPU itself uses when communicating with its own special components. This section covers some very technical items and it is strongly recommended that only experienced users should make any changes to the default settings.

BIOS SETUP UTILITY						
Main	Advanced	PCIPnP	Boot	Security	Chipset	Exit
Advanced PCI/PnP Settings						
WARNING: Setting wrong values in below sections may cause system to malfunction.						
Clean NVRAM			[No]			
Plug & Play O/S			[No]			
PCI Latency Timer			[64]			
Allocate IRQ to PCI VGA			[Yes]			
Palette Snooping			[Disabled]			
PCI IDE BusMaster			[Disabled]			
Offboard PCI/ISA IDE Card			[Auto]			
IRQ3			[Available]			
IRQ4			[Available]			
IRQ5			[Available]			
IRQ7			[Available]			
IRQ9			[Available]			
IRQ10			[Available]			
IRQ11			[Available]			
IRQ14			[Available]			
IRQ15			[Available]			
DMA Channel 0			[Available]			
DMA Channel 1			[Available]		←	Select Screen
DMA Channel 3			[Available]		↑ ↓	Select Item
DMA Channel 5			[Available]		+ -	Change Field
DMA Channel 6			[Available]		Tab	Select Field
DMA Channel 7			[Available]		F1	General Help
					F10	Save and Exit
Reserved Memory Size			[Disabled]		ESC	Exit
v02.59 (C)Copyright 1985-2005, American Megatrends, Inc.						

4.6 Boot Settings

BIOS SETUP UTILITY

Main	Advanced	PCIPnP	Boot	Security	Chipset	Exit
Boot Settings Configuration						
Quick Boot			[Enabled]			
Quiet Boot			[Disabled]			
AddOn ROM Display Mode			[Force BIOS]			
Bootup Nom-Lock			[On]			
PS/2 Mouse Support			[Auto]	←	Select Screen	
Wait For 'F1' If Error			[Enabled]	↑ ↓	Select Item	
Hit 'DEL' Message Display			[Enabled]	+ -	Change Field	
Interrupt 19 Capture			[Disabled]	Tab	Select Field	
				F1	General Help	
				F10	Save and Exit	
				ESC	Exit	
v02.59 (C)Copyright 1985-2005, American Megatrends, Inc.						

BIOS SETUP UTILITY

Main	Advanced	PCIPnP	Boot	Security	Chipset	Exit
Boot Device Priority						
1st Boot Device			[USB:USB Hotplug FD]			
				←	Select Screen	
				↑ ↓	Select Item	
				+ -	Change Field	
				Tab	Select Field	
				F1	General Help	
				F10	Save and Exit	
				ESC	Exit	
v02.59 (C)Copyright 1985-2005, American Megatrends, Inc.						

BIOS SETUP UTILITY

Main	Advanced	PCIPnP	Boot	Security	Chipset	Exit
Removable Drives						
1st Drive			[USB:USB Hotplug FD]			
				←	Select Screen	
				↑ ↓	Select Item	
				+ -	Change Field	
				Tab	Select Field	
				F1	General Help	
				F10	Save and Exit	
				ESC	Exit	
v02.59 (C)Copyright 1985-2005, American Megatrends, Inc.						

4.7 Security Settings

BIOS SETUP UTILITY						
Main	Advanced	PCIPnP	Boot	Security	Chipset	Exit
Security Settings						
Supervisor Password		: Not Installed				
User Password		: Not Installed				
Change Supervisor Password				←	Select Screen	
Change User Password				↑ ↓	Select Item	
Boot Sector Virus Protection [Disabled]				+ -	Change Field	
Hard Disk Security				Tab	Select Field	
There are no supported Hard Disks.				F1	General Help	
				F10	Save and Exit	
				ESC	Exit	
v02.59 (C)Copyright 1985-2005, American Megatrends, Inc.						

4.8 Advanced Chipset Settings

BIOS SETUP UTILITY						
Main	Advanced	PCIPnP	Boot	Security	Chipset	Exit
Advanced Chipset Settings						
WARNING: Setting wrong values in below sections may cause system to malfunction.						
▶ North Bridge Chipset Configuration						
▶ South Bridge Chipset Configuration						
				←	Select Screen	
				↑ ↓	Select Item	
				+ -	Change Field	
				Tab	Select Field	
				F1	General Help	
				F10	Save and Exit	
				ESC	Exit	
v02.59 (C)Copyright 1985-2005, American Megatrends, Inc.						

BIOS SETUP UTILITY

Main	Advanced	PCIPnP	Boot	Security	Chipset	Exit
North Bridge Chipset Configuration						
DRAM Frequency			[Auto]			
Configure DRAM Timing by SPD			[Enabled]			
Memory Hole			[Disabled]			
Boots Graphic Adapter Priority			[PEG/PCI]			
Internal Graphics Mode Select			[Enabled, 8MB]			
PEG Port Configuration						
PEG Port			[Auto]			
PEG Force x1			[Disabled]			
Chipset Thermal Throttling			[Disabled]		←	Select Screen
DT in SPD			[Disabled]		↑ ↓	Select Item
TS on DIMM			[Disabled]		+ -	Change Field
					Tab	Select Field
					F1	General Help
▶ Video Function Configuration					F10	Save and Exit
					ESC	Exit
v02.59 (C)Copyright 1985-2005, American Megatrends, Inc.						

BIOS SETUP UTILITY

Main	Advanced	PCIPnP	Boot	Security	Chipset	Exit
Video Function Configuration						
DVMT Mode Select			[DVMT Mode]			
DVMT/FIXED Memory			[128MB]			
Boot Display Device			[CRT]			
Flat Panel Type			[800x600LVDS]			
Local Flat Panel Scaling			[Auto]			
TV Connector			[Auto]			
HDTV Output			[Auto]			
TV Standard			[VBIOS-Default]			
					←	Select Screen
					↑ ↓	Select Item
					+ -	Change Field
					Tab	Select Field
					F1	General Help
					F10	Save and Exit
					ESC	Exit
v02.59 (C)Copyright 1985-2005, American Megatrends, Inc.						

BIOS SETUP UTILITY

Main	Advanced	PCIPnP	Boot	Security	Chipset	Exit
Sorth Bridge Chipset Configuration						
USB Function		[8 USB Ports]				
USB 2.0 Controller		[Enabled]				
Audio Controller		[AC'97 Audio Only]				
PRO-NIC Controller		[Disabled]				
SMBUS Controller		[Enabled]				
Reserved Page Route		[LPC]				
SLP_S4# Min. Assertion Width		[1 to 2 seconds]				
Restore on AC Power Loss		[Last State]				
PCIE Ports Configuration						
ONBOARD LAN 1		[Auto]				
ONBOARD LAN 2		[Auto]				
PCIE SLOT 1		[Auto]				
ASF Support		[Enabled]				
						← Select Screen
						↑ ↓ Select Item
						+ - Change Field
						Tab Select Field
						F1 General Help
						F10 Save and Exit
						ESC Exit
v02.59 (C)Copyright 1985-2005, American Megatrends, Inc.						

4.9 Exit Options

BIOS SETUP UTILITY

Main	Advanced	PCIPnP	Boot	Security	Chipset	Exit
Exit Options						
Save Changes and Exit						
Discard Changes and Exit						
Discard Changes						
Load Optimal Defaults						
Load Failsafe Defaults						
						← Select Screen
						↑ ↓ Select Item
						+ - Change Field
						Tab Select Field
						F1 General Help
						F10 Save and Exit
						ESC Exit
v02.59 (C)Copyright 1985-2005, American Megatrends, Inc.						

Chapter 5

Software Utilities

This chapter contains the detailed information of IDE, VGA, LAN and audio driver installation procedures. The utility disk that comes with the delivery package contains an auto-run program that invokes the installation programs for the IDE, VGA, LAN and audio drivers. The following sections describe the installation procedures of each driver based on WIN2K/XP operating systems. It is recommended that you install the drivers matching the sections listed in this chapter.

5.1 IDE Driver Installation

1. With the Utility CD Disk in you CD-ROM drive, open the **File Manager** and then select the CD-ROM drive. Open the **Infinst** folder and click **Setup.exe** to start proceed.

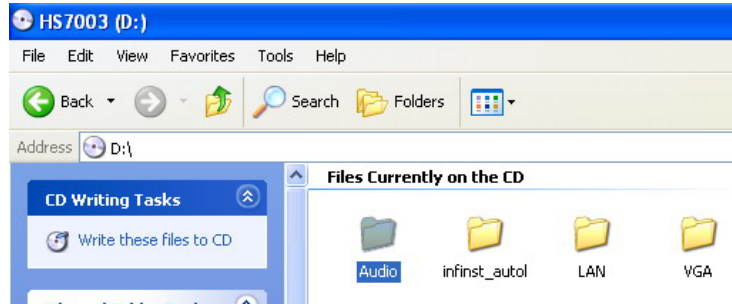

2. Once the **Install Shield Wizard** screen appears on the screen, make sure to close applications that are running and then click on **Next>** button.

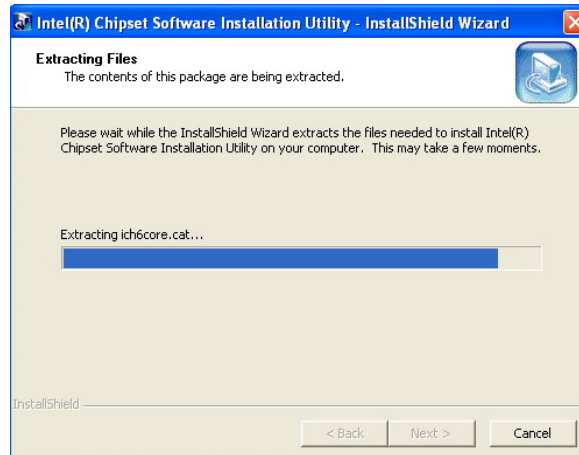

3. The **Welcome** screen is now displayed, and then click on **Next >** button to continue.

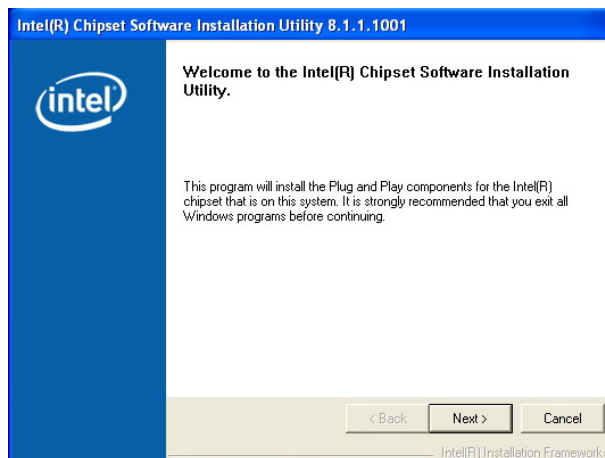

4. The **License Agreement** dialog box then appears on the screen. Choose **Yes** to proceed.

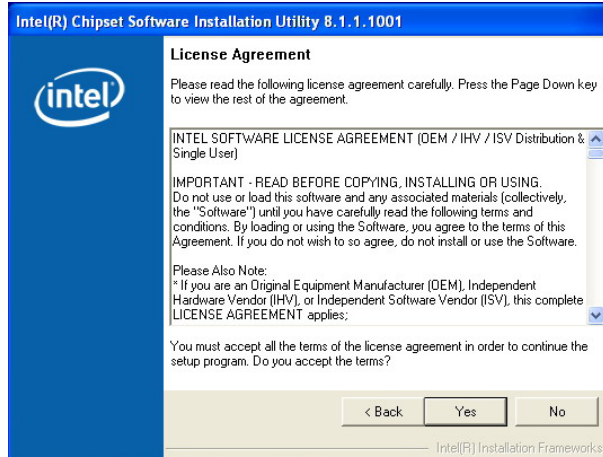

5. When the **Readme File Information** dialog box pops up, just click on the **Next >** button to proceed.

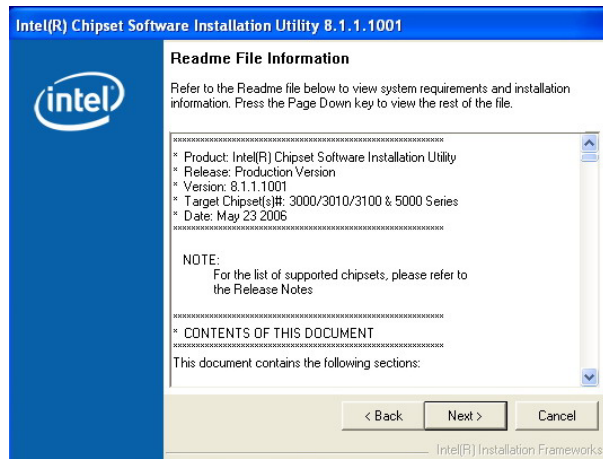

6. Once the **Install Shield Wizard** finishes updating your system, it will prompt you to restart the computer. Tick on the **Yes, I want to restart my computer** now followed by a click on the **Finish** button to reboot. Only after your computer boots will the new settings take effect.

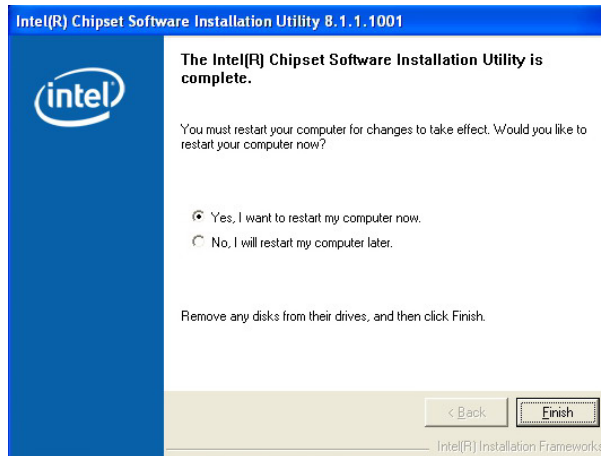

5.2 VGA Driver Installation

1. With the Utility CD Disk in you CD-ROM drive, open the **File Manager** and then select the CD-ROM drive. Open the **VGA** folder and click **Setup.exe** to start proceed.

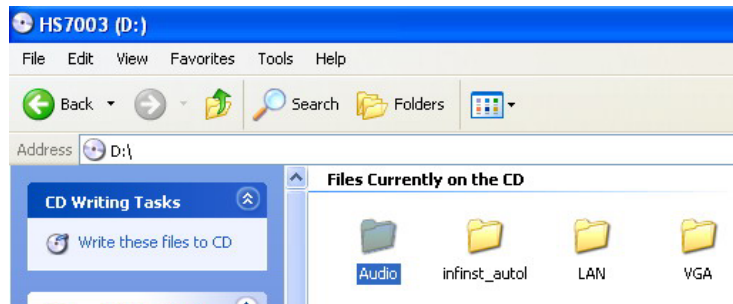

2. Once the Setup Wizard appears on the screen and click on the **Next >** button.

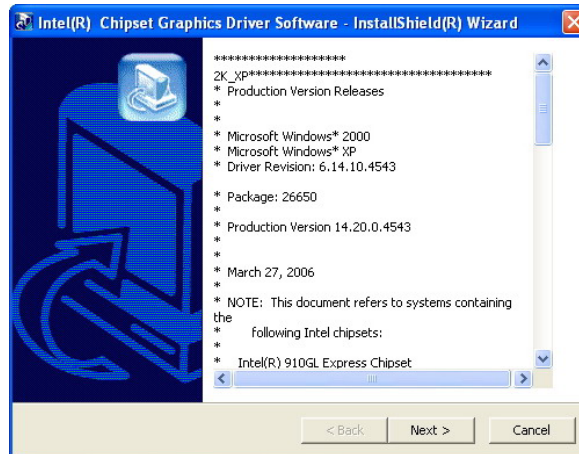

3. Setup Wizard will extracting files to your hard drive, and then click on **Next>** to continue.

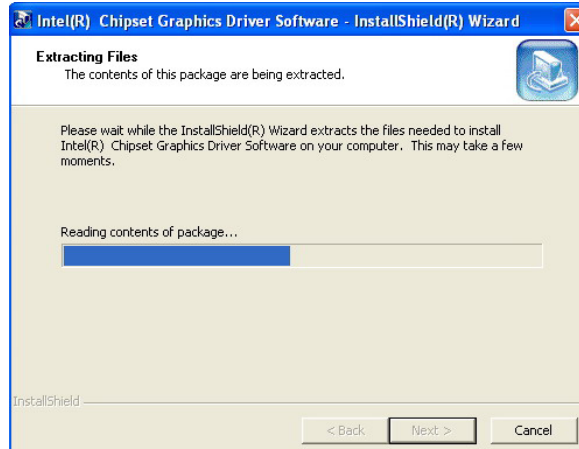

4. When the dialog box below appears, make sure you close all other Windows applications then click on the **Next >** button to proceed.

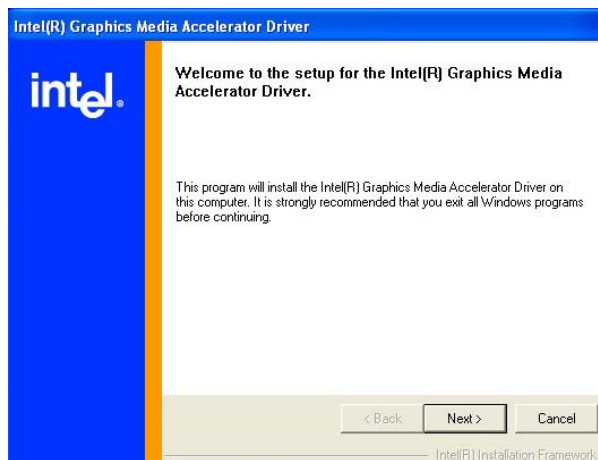

5. The **Intel® OEM Software License Agreement** dialog box appears on the screen. Choose **Yes** to proceed.

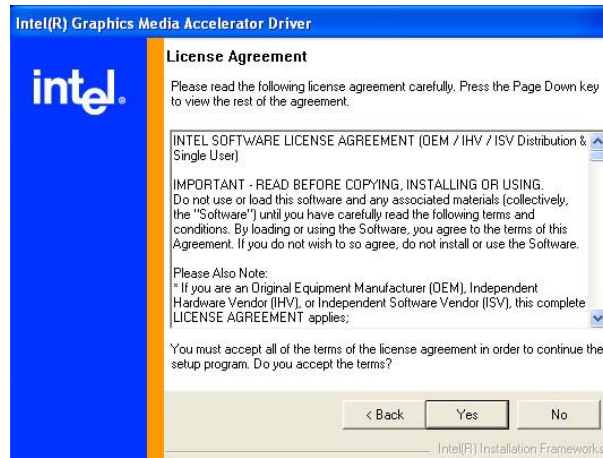

6. After all installation finish, you will be prompted to start your system, click on the **Finish** button to reboot.

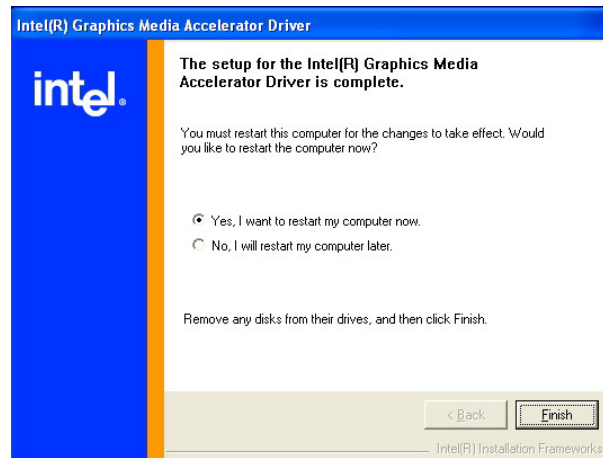

5.3 Audio Driver Installation

1. With the Utility CD Disk in you CD-ROM drive, open the **File Manager** and then select the CD-ROM drive. Open the **Audio** folder and click **Setup.exe** to start proceed.

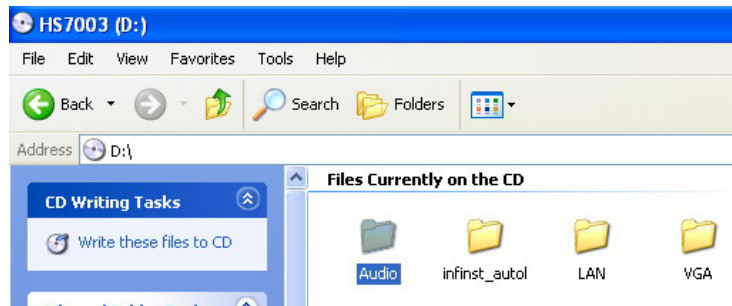

2. Once the **Install Shield Wizard** screen appears on the screen, make sure to close applications that are running and then click on **Next>** button.

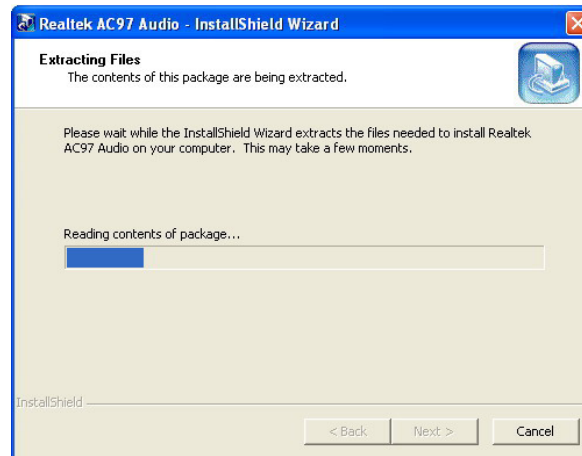

3. Realtek AC97 Audio Setup is preparing the **Install Shield Wizard**, which will guide you through the rest of the setup process.

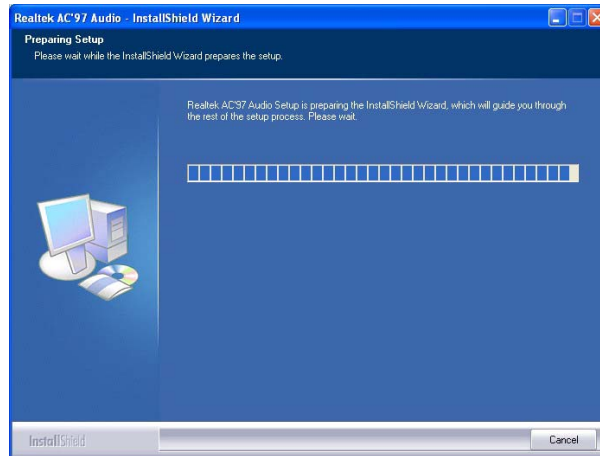

4. Realtek AC97 Audio is configuring your new software installation.

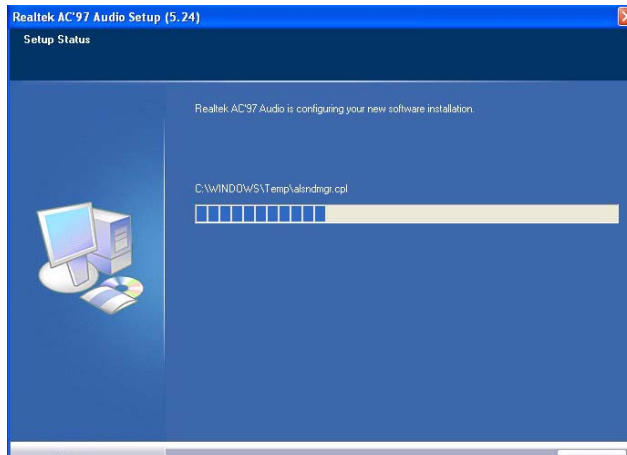

5. Begin to install/update AC97 drivers.

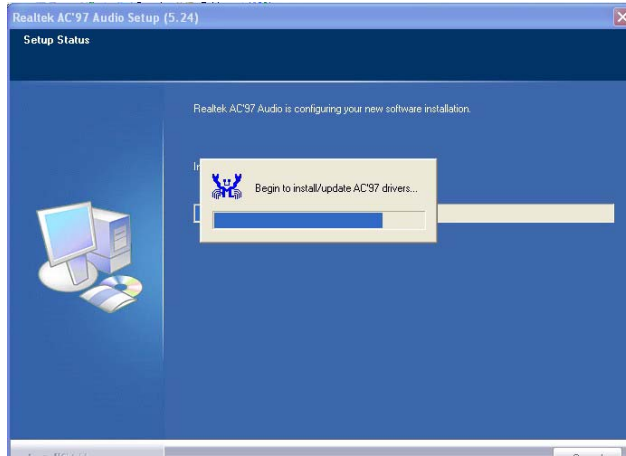

6. After all installation finish, you will be prompted to start your system, click on the **Finish** button to reboot.

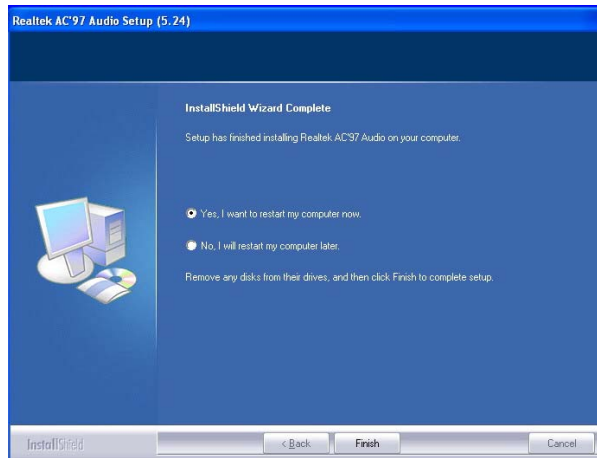

5.4 LAN Driver Installation

1. With the Utility CD Disk in your CD-ROM drive, right click on **"My Computer"** icon from the Windows menu. Select on **System Properties** and then proceed to the **Device Manager** from the main menu.

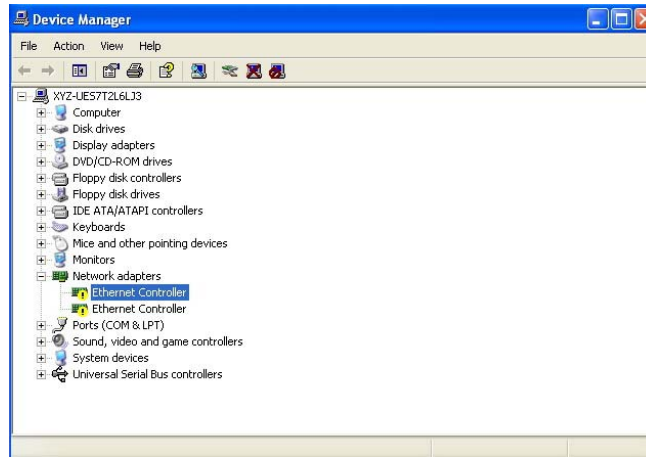

2. Select on **Ethernet Controller** from the list of devices then double-click. The **Ethernet Controller Properties** screen then appears, select **Reinstall Driver** from the main menu to proceed.

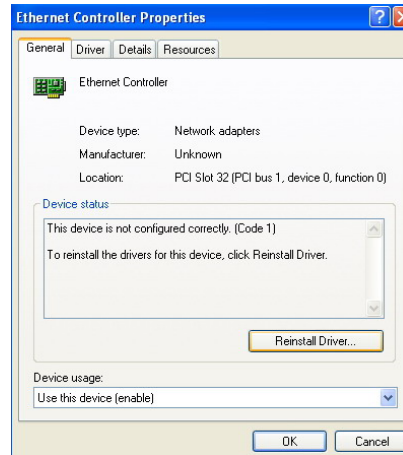

3. Tick on the **Install the software automatically (Recommended)** once the following screen appears, click on the **Next >** to proceed.



4. The **Hardware Update Wizard** is copying files into your hard drive.

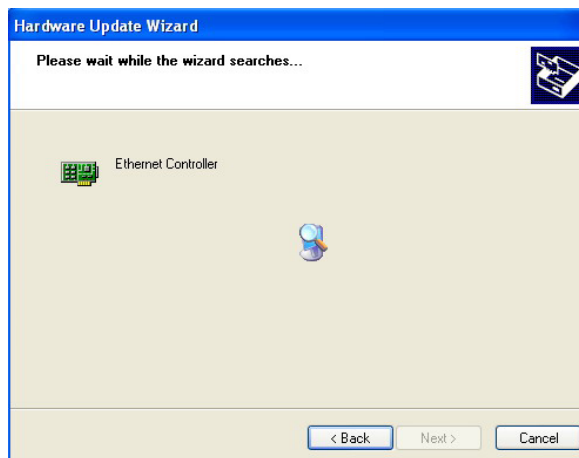

5. The Hardware Installation will pop up the screen below, click on **Continue Anyway**.



6. **Hardware Update Wizard** is installs the software, and then click on **Next >** to continue.

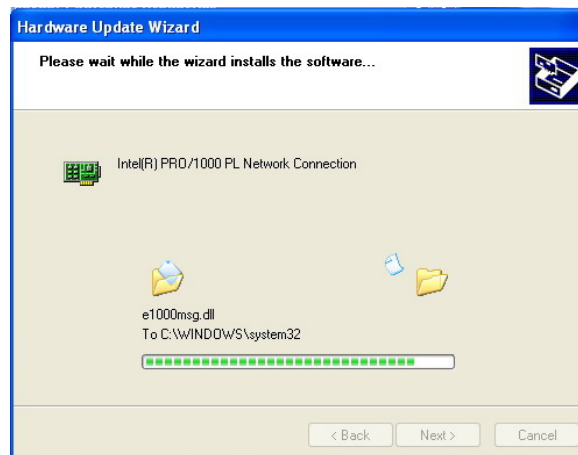

7. Once the **Install Shield Wizard** completes the operation and update of your USB2.0 driver. Click on the **Finish** button to complete the installation process.



NOTE: Please repeat Step.1 ~ Step.7 to install LAN 2.