



Intel® Desktop Board D845BG/D845PT Technical Product Specification



November 2001

Order Number: A75852-001

The Intel® Desktop Boards D845BG/D845PT may contain design defects or errors known as errata that may cause the product to deviate from published specifications. Current characterized errata are documented in the Intel Desktop Board D845BG/D845PT Specification Update.

Revision History

Revision	Revision History	Date
-001	First release of the Intel® Desktop Board D845BG/D845PT Technical Product Specification.	November 2001

This product specification applies to only standard D845BG and D845PT boards with BIOS identifier PT84510A.86A.

Changes to this specification will be published in the Intel Desktop Board D845BG/D845PT Specification Update before being incorporated into a revision of this document.

INFORMATION IN THIS DOCUMENT IS PROVIDED IN CONNECTION WITH INTEL® PRODUCTS. EXCEPT AS PROVIDED IN INTEL'S TERMS AND CONDITIONS OF SALE FOR SUCH PRODUCTS, INTEL ASSUMES NO LIABILITY WHATSOEVER, AND INTEL DISCLAIMS ANY EXPRESS OR IMPLIED WARRANTY, RELATING TO SALE AND/OR USE OF INTEL PRODUCTS INCLUDING LIABILITY OR WARRANTIES RELATING TO FITNESS FOR A PARTICULAR PURPOSE, MERCHANTABILITY, OR INFRINGEMENT OF ANY PATENT, COPYRIGHT, OR OTHER INTELLECTUAL PROPERTY RIGHT.

Intel Corporation may have patents or pending patent applications, trademarks, copyrights, or other intellectual property rights that relate to the presented subject matter. The furnishing of documents and other materials and information does not provide any license, express or implied, by estoppel or otherwise, to any such patents, trademarks, copyrights, or other intellectual property rights.

Intel products are not intended for use in medical, life saving, or life sustaining applications or for any other application in which the failure of the Intel product could create a situation where personal injury or death may occur.

Intel may make changes to specifications, product descriptions, and plans at any time, without notice.

The Intel® Desktop Boards D845BG and D845PT may contain design defects or errors known as errata that may cause the product to deviate from published specifications. Current characterized errata are available on request.

Contact your local Intel sales office or your distributor to obtain the latest specifications before placing your product order.

Copies of documents which have an ordering number and are referenced in this document, or other Intel literature, may be obtained from:

Intel Corporation
P.O. Box 5937
Denver, CO 80217-9808

or call in North America 1-800-548-4725, Europe 44-0-1793-431-155, France 44-0-1793-421-777,
Germany 44-0-1793-421-333, other Countries 708-296-9333.

Intel and Pentium are registered trademarks of Intel Corporation or its subsidiaries in the United States and other countries.

† Other names and brands may be claimed as the property of others.

Copyright © 2001, Intel Corporation. All rights reserved.

Preface

This Technical Product Specification (TPS) specifies the board layout, components, connectors, power and environmental requirements, and the BIOS for these Intel® Desktop Boards: D845BG and D845PT. It describes the standard product and available manufacturing options.

Intended Audience

The TPS is intended to provide detailed, technical information about the D845BG and D845PT boards and their components to the vendors, system integrators, and other engineers and technicians who need this level of information. It is specifically *not* intended for general audiences.

What This Document Contains

Chapter	Description
1	A description of the hardware used on the D845BG and D845PT boards
2	A map of the resources of the boards
3	The features supported by the BIOS Setup program
4	The contents of the BIOS Setup program's menus and submenus
5	A description of the BIOS error messages, beep codes, and POST codes

Typographical Conventions

This section contains information about the conventions used in this specification. Not all of these symbols and abbreviations appear in all specifications of this type.

Notes, Cautions, and Warnings

NOTE

Notes call attention to important information.

CAUTION

Cautions are included to help you avoid damaging hardware or losing data.

WARNING

Warnings indicate conditions, which if not observed, can cause personal injury.

Other Common Notation

#	Used after a signal name to identify an active-low signal (such as USBP0#)
(NxnX)	When used in the description of a component, N indicates component type, xn are the relative coordinates of its location on the D845BG and D845PT boards, and X is the instance of the particular part at that general location. For example, J5J1 is a connector, located at 5J. It is the first connector in the 5J area.
GB	Gigabyte (1,073,741,824 bytes)
GB/sec	Gigabytes per second
KB	Kilobyte (1024 bytes)
Kbit	Kilobit (1024 bits)
kbits/sec	1000 bits per second
MB	Megabyte (1,048,576 bytes)
MB/sec	Megabytes per second
Mbit	Megabit (1,048,576 bits)
Mbit/sec	Megabits per second
xxh	An address or data value ending with a lowercase h indicates a hexadecimal value.
x.x V	Volts. Voltages are DC unless otherwise specified.
†	This symbol is used to indicate third-party brands and names that are the property of their respective owners.

Contents

1 Product Description

1.1	Board Differences.....	11
1.2	Overview	12
1.2.1	Feature Summary	12
1.2.2	Manufacturing Options	13
1.2.3	Board Layouts.....	14
1.2.4	Block Diagram.....	16
1.3	Online Support	18
1.4	Operating System Support	18
1.5	Design Specifications	19
1.6	Processor	22
1.7	System Memory	23
1.8	Intel® 845 Chipset.....	25
1.8.1	AGP	26
1.8.2	USB.....	27
1.8.3	IDE Support	29
1.8.4	Real-Time Clock, CMOS SRAM, and Battery.....	30
1.8.5	Intel® 82802AB 4 Mbit Firmware Hub (FWH)	30
1.9	I/O Controller	30
1.9.1	Serial Ports	31
1.9.2	Parallel Port.....	31
1.9.3	Diskette Drive Controller	32
1.9.4	Keyboard and Mouse Interface	32
1.10	Audio Subsystem.....	33
1.10.1	Audio Connectors.....	34
1.10.2	Audio Subsystem Software	34
1.11	LAN Subsystem (Optional)	35
1.11.1	Intel® 82562ET Platform LAN Connect Device.....	35
1.11.2	RJ-45 LAN Connector with Integrated LEDs	35
1.11.3	LAN Subsystem Software	36
1.12	CNR (Optional).....	36
1.13	Hardware Management Subsystem.....	37
1.13.1	Hardware Monitor Component	37
1.13.2	Fan Monitoring	37
1.13.3	Chassis Intrusion and Detection.....	38
1.14	Power Management	38
1.14.1	ACPI.....	38
1.14.2	Hardware Support	42

2 Technical Reference

2.1	Introduction.....	47
2.2	Memory Map	47
2.3	I/O Map	48
2.4	DMA Channels	50
2.5	PCI Configuration Space Map	50
2.6	Interrupts	51
2.7	PCI Interrupt Routing Map.....	52
2.8	Connectors	54
2.8.1	Back Panel Connectors.....	55
2.8.2	Internal I/O Connectors	58
2.8.3	External I/O Connectors.....	71
2.9	Jumper Blocks.....	75
2.9.1	Front Panel Audio Connector/Jumper Block.....	75
2.9.2	BIOS Setup Configuration Jumper Block.....	76
2.10	Mechanical Considerations.....	77
2.10.1	D845BG Form Factor	77
2.10.2	D845PT Form Factor.....	78
2.10.3	I/O Shield	79
2.11	Electrical Considerations	82
2.11.1	Power Consumption	82
2.11.2	Add-in Board Considerations.....	82
2.11.3	Standby Current Requirements	83
2.11.4	Fan Connector Current Capability	84
2.11.5	Power Supply Considerations	84
2.12	Thermal Considerations.....	85
2.13	Reliability	87
2.14	Environmental	87
2.15	Regulatory Compliance	88
2.15.1	Safety Regulations	88
2.15.2	EMC Regulations	88
2.15.3	Product Certification Markings (Board Level)	89

3 Overview of BIOS Features

3.1	Introduction.....	91
3.2	BIOS Flash Memory Organization	92
3.3	Resource Configuration	92
3.3.1	PCI Autoconfiguration	92
3.3.2	PCI IDE Support.....	92
3.4	System Management BIOS (SMBIOS).....	93
3.5	Legacy USB Support	93
3.6	BIOS Updates	94
3.6.1	Language Support.....	95
3.6.2	Custom Splash Screen.....	95
3.7	Recovering BIOS Data	95

3.8	Boot Options.....	96
3.8.1	CD-ROM and Network Boot.....	96
3.8.2	Booting Without Attached Devices.....	96
3.9	Fast Booting Systems with Intel® Rapid BIOS Boot.....	96
3.9.1	Peripheral Selection and Configuration.....	96
3.9.2	Intel Rapid BIOS Boot.....	97
3.10	BIOS Security Features.....	98
4	BIOS Setup Program	
4.1	Introduction.....	99
4.2	Maintenance Menu.....	100
4.2.1	Extended Configuration Submenu.....	101
4.3	Main Menu.....	102
4.4	Advanced Menu.....	103
4.4.1	PCI Configuration Submenu.....	104
4.4.2	Boot Configuration Submenu.....	105
4.4.3	Peripheral Configuration Submenu.....	106
4.4.4	IDE Configuration Submenu.....	108
4.4.5	Diskette Configuration Submenu.....	111
4.4.6	Event Log Configuration Submenu.....	112
4.4.7	Video Configuration Submenu.....	113
4.5	Security Menu.....	114
4.6	Power Menu.....	115
4.6.1	ACPI Submenu.....	116
4.7	Boot Menu.....	117
4.7.1	Boot Device Priority Submenu.....	118
4.7.2	Hard Disk Drives Submenu.....	119
4.7.3	Removable Devices Submenu.....	119
4.7.4	ATAPI CD-ROM Drives Submenu.....	120
4.8	Exit Menu.....	120
5	Error Messages and Beep Codes	
5.1	BIOS Error Messages.....	121
5.2	Port 80h POST Codes.....	123
5.3	Bus Initialization Checkpoints.....	127
5.4	Speaker.....	128
5.5	BIOS Beep Codes.....	128
Figures		
1.	D845BG Board Components.....	14
2.	D845PT Board Components.....	15
3.	Block Diagram.....	16
4.	Block Diagram with Optional USB 2.0 Support.....	17
5.	Intel 845 Chipset Block Diagram.....	25
6.	USB 1.1 Port Configuration.....	27
7.	USB 2.0 Port Configuration (Optional).....	28
8.	Audio Subsystem Block Diagram.....	33
9.	ICH2 and CNR Signal Interface.....	36

10.	Location of the Standby Power Indicator LED	44
11.	Back Panel Connectors	55
12.	Audio Connectors	59
13.	Power and Hardware Control Connectors	61
14.	D845BG Add-in Board and Peripheral Interface Connectors	64
15.	D845PT Add-in Board and Peripheral Interface Connectors.....	65
16.	External I/O Connectors	71
17.	Location of the Jumper Blocks.....	75
18.	D845BG Board Dimensions.....	77
19.	D845PT Board Dimensions	78
20.	I/O Shield Dimensions (for boards with the LAN Subsystem, but not USB 2.0)	79
21.	I/O Shield Dimensions (for boards with neither the LAN Subsystem nor USB 2.0)	80
22.	I/O Shield Dimensions (for boards without the LAN Subsystem, but with USB 2.0)	81
23.	Localized High Temperature Zones.....	86

Tables

1.	Summary of Board Differences.....	11
2.	Feature Summary.....	12
3.	Manufacturing Options	13
4.	Specifications	19
5.	Supported Processors	22
6.	Supported Memory Configurations	24
7.	LAN Connector LED States	35
8.	Effects of Pressing the Power Switch	39
9.	Power States and Targeted System Power	40
10.	Wake-up Devices and Events.....	41
11.	Fan Connector Function/Operation.....	43
12.	System Memory Map.....	47
13.	I/O Map	48
14.	DMA Channels	50
15.	PCI Configuration Space Map	50
16.	Interrupts	51
17.	PCI Interrupt Routing Map.....	53
18.	PS/2 Mouse/Keyboard Connector	56
19.	USB Connectors.....	56
20.	Parallel Port Connector.....	56
21.	Serial Port A Connector	57
22.	LAN Connector (Optional)	57
23.	Audio Line In Connector	57
24.	Audio Line Out Connector	57
25.	Mic In Connector	57
26.	Auxiliary Line In Connector.....	60
27.	ATAPI CD-ROM Connector	60
28.	ATX12V Power Connector.....	62
29.	Rear Chassis Fan Connector	62
30.	Processor Fan Connector.....	62
31.	Main Power Connector	63

32.	Front Chassis Fan Connector	63
33.	Chassis Intrusion Connector	63
34.	CNR Connector (Optional)	66
35.	PCI Bus Connectors	67
36.	AGP Connector	68
37.	Diskette Drive Connector	69
38.	PCI IDE Connectors	70
39.	SCSI LED Connector	70
40.	Front Panel Audio Connector	72
41.	Serial Port B Connector	72
42.	Front Panel USB Connector	72
43.	Auxiliary Front Panel Power/Sleep/Message-Waiting LED Connector	72
44.	Front Panel Connector	73
45.	States for a One-Color Power LED	73
46.	States for a Two-Color Power LED	74
47.	Front Panel Audio Connector/Jumper Block	76
48.	BIOS Setup Configuration Jumper Settings	76
49.	Power Usage	82
50.	Standby Current Requirements	83
51.	Fan Connector Current Capability	84
52.	Thermal Considerations for Components	86
53.	D845BG/D845PT Board Environmental Specifications	87
54.	Safety Regulations	88
55.	EMC Regulations	88
56.	Supervisor and User Password Functions	98
57.	BIOS Setup Program Menu Bar	99
58.	BIOS Setup Program Function Keys	100
59.	Maintenance Menu	100
60.	Extended Configuration Submenu	101
61.	Main Menu	102
62.	Advanced Menu	103
63.	PCI Configuration Submenu	104
64.	Boot Configuration Submenu	105
65.	Peripheral Configuration Submenu	106
66.	IDE Configuration Submenu	108
67.	Primary/Secondary IDE Master/Slave Submenus	109
68.	Diskette Configuration Submenu	111
69.	Event Log Configuration Submenu	112
70.	Video Configuration Submenu	113
71.	Security Menu	114
72.	Power Menu	115
73.	ACPI Submenu	116
74.	Boot Menu	117
75.	Boot Device Priority Submenu	118
76.	Hard Disk Drives Submenu	119
77.	Removable Devices Submenu	119
78.	ATAPI CD-ROM Drives Submenu	120
79.	Exit Menu	120

80.	BIOS Error Messages.....	121
81.	Uncompressed INIT Code Checkpoints.....	123
82.	Boot Block Recovery Code Checkpoints	123
83.	Runtime Code Uncompressed in F000 Shadow RAM	124
84.	Bus Initialization Checkpoints	127
85.	Upper Nibble High Byte Functions.....	127
86.	Lower Nibble High Byte Functions.....	128
87.	Beep Codes.....	129

1 Product Description

What This Chapter Contains

1.1	Board Differences.....	11
1.2	Overview	12
1.3	Online Support	18
1.4	Operating System Support	18
1.5	Design Specifications	19
1.6	Processor	22
1.7	System Memory	23
1.8	Intel® 845 Chipset.....	25
1.9	I/O Controller	30
1.10	Audio Subsystem.....	33
1.11	LAN Subsystem (Optional)	35
1.12	CNR (Optional).....	36
1.13	Hardware Management Subsystem.....	37
1.14	Power Management	38

1.1 Board Differences

This TPS describes these Intel® Desktop boards: D845BG and D845PT. The boards are identical with the exception of the items listed in Table 1.

Table 1. Summary of Board Differences

D845BG	<ul style="list-style-type: none">• ATX Form Factor (12.00 inches by 8.20 inches)• Six PCI bus connectors (Note)• Optional Universal Serial Bus (USB) 2.0
D845PT	<ul style="list-style-type: none">• microATX Form Factor (9.60 inches by 8.20 inches)• Three PCI bus connectors

Note: All D845BG boards with the NEC μ PD720100 USB 2.0 host controller have only five PCI bus connectors.

NOTE

Most of the illustrations in this document show only the D845PT board. When there are significant differences between the two boards, illustrations of both boards are provided.

1.2 Overview

1.2.1 Feature Summary

Table 2 summarizes the D845BG and D845PT boards' major features.

Table 2. Feature Summary

Form Factor	D845BG: ATX (12.00 inches by 8.20 inches) D845PT: microATX (9.60 inches by 8.20 inches)
Processor	<ul style="list-style-type: none"> Support for an Intel® Pentium® 4 processor in a µPGA478 socket 400 MHz system bus
Memory	<ul style="list-style-type: none"> Two 184-pin DDR SDRAM Dual Inline Memory Module (DIMM) sockets Support for single-sided or double-sided DIMMs (DDR 200 and DDR 266) Support for up to 2 GB system memory <p>NOTE: <i>The D845BG/D845PT boards have been designed to support DIMMs based on 512 Mbit technology for a maximum onboard capacity of up to 2 GB, but this technology has not been validated on this board. Please refer to the following Intel web sites. For the D845BG board:</i> http://developer.intel.com/design/motherbd/bg/bg_mem.htm</p> <p><i>For the D845PT board:</i> http://developer.intel.com/design/motherbd/pt/pt_mem.htm</p>
Chipset	Intel® 845 Chipset, consisting of: <ul style="list-style-type: none"> Intel® 82845 Memory Controller Hub (MCH) Intel® 82801BA I/O Controller Hub (ICH2) Intel® 82802AB 4 Mbit Firmware Hub (FWH)
Audio	Audio subsystem for AC '97 processing using the Analog Devices AD1885 codec
Video	AGP connector supporting 1.5 V 4X AGP cards
I/O Control	SMSC LPC47M142 LPC Bus I/O controller
Peripheral Interfaces	<ul style="list-style-type: none"> Up to seven USB ports Two serial ports One parallel port Two IDE interfaces with UDMA 33, ATA-66/100 support One diskette drive interface PS/2[†] keyboard and mouse ports Three fan connectors
Expansion Capabilities	<ul style="list-style-type: none"> D845BG: Six PCI bus add-in card connectors (SMBus routed to PCI bus connector 1) D845PT: Three PCI bus add-in card connectors (SMBus routed to PCI bus connector 1)
Hardware Monitor Subsystem	<ul style="list-style-type: none"> Voltage sense to detect out of range power supply voltages Thermal sense to detect out of range thermal values Two fan sense inputs used to monitor fan activity

continued

Table 2. Feature Summary (continued)

BIOS	<ul style="list-style-type: none"> • Intel/AMI BIOS (resident in the Intel 82802AB 4 Mbit FWB) • Support for Advanced Configuration and Power Interface (ACPI), Plug and Play, and SMBIOS
Instantly Available PC Technology	<ul style="list-style-type: none"> • Support for PCI Local Bus Specification Revision 2.2 • Suspend to RAM support • Wake on PCI, CNR, RS-232, front panel, PS/2 devices, and USB ports

For information about	Refer to
The board's compliance level with ACPI, Plug and Play, and SMBIOS.	Section 1.5, page 19

1.2.2 Manufacturing Options

Table 3 describes the D845BG and D845PT boards' manufacturing options. Not every manufacturing option is available in all marketing channels. Please contact your Intel representative to determine which manufacturing options are available to you.

Table 3. Manufacturing Options

CNR	One Communication and Networking Riser (CNR) connector (slot shared with PCI bus connector 6 on the D845BG board and with PCI bus connector 3 on the D845PT board)
LAN	Intel® 82562ET 10/100 Mbit/sec Platform LAN Connect (PLC) device
USB 2.0	Support for USB 2.0 devices. The USB 2.0 option uses the NEC μ PD720100 USB 2.0 host controller and supports up to five USB ports. This option is currently available only on the D845BG board.

For information about	Refer to
Available configurations for the D845BG and D845PT boards	Section 1.3, page 18

NOTE

The LAN and the CNR manufacturing options are mutually exclusive.

1.2.3 Board Layouts

Figure 1 shows the location of the major components on the D845BG board.

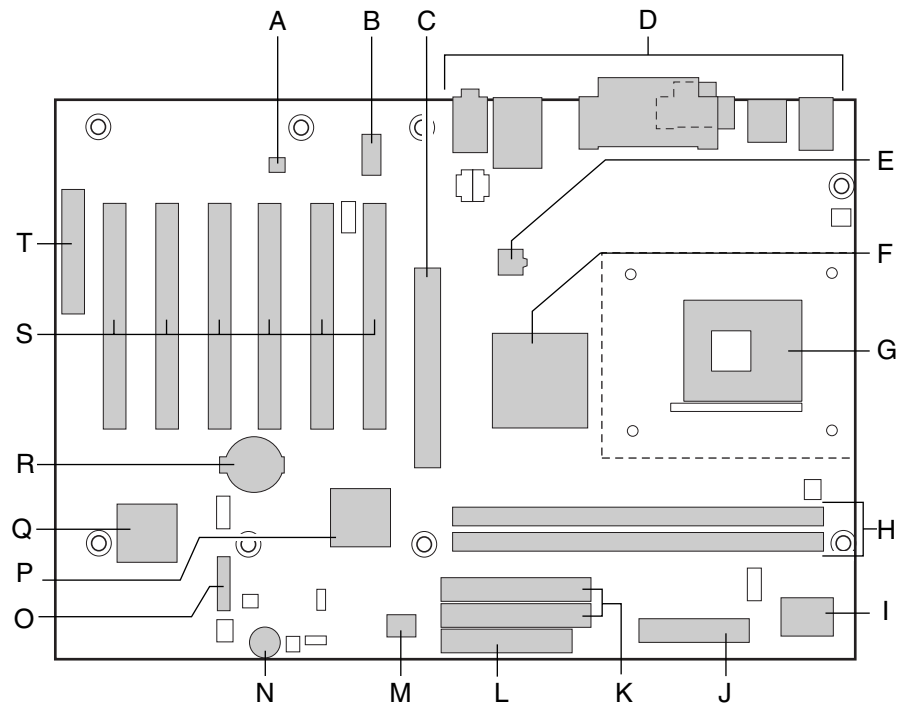

OM12997

- | | | | |
|---|---|---|---|
| A | Audio codec | K | IDE connectors |
| B | Intel 82562ET PLC device (optional) | L | Diskette drive connector |
| C | AGP connector | M | Intel 82802AB 4 Mbit Firmware Hub (FWH) |
| D | Back panel connectors | N | Speaker |
| E | +12 V power connector (ATX12V) | O | Front panel connector |
| F | Intel 82845 Memory Controller Hub (MCH) | P | Intel 82801BA I/O Controller Hub (ICH2) |
| G | μ PGA478 processor socket | Q | NEC μ PD720100 USB 2.0 host controller (optional) |
| H | DIMM sockets | R | Battery |
| I | I/O controller | S | PCI bus add-in card connectors |
| J | Power connector | T | CNR connector (optional) |

Figure 1. D845BG Board Components

Figure 2 shows the location of the major components on the D845PT board.

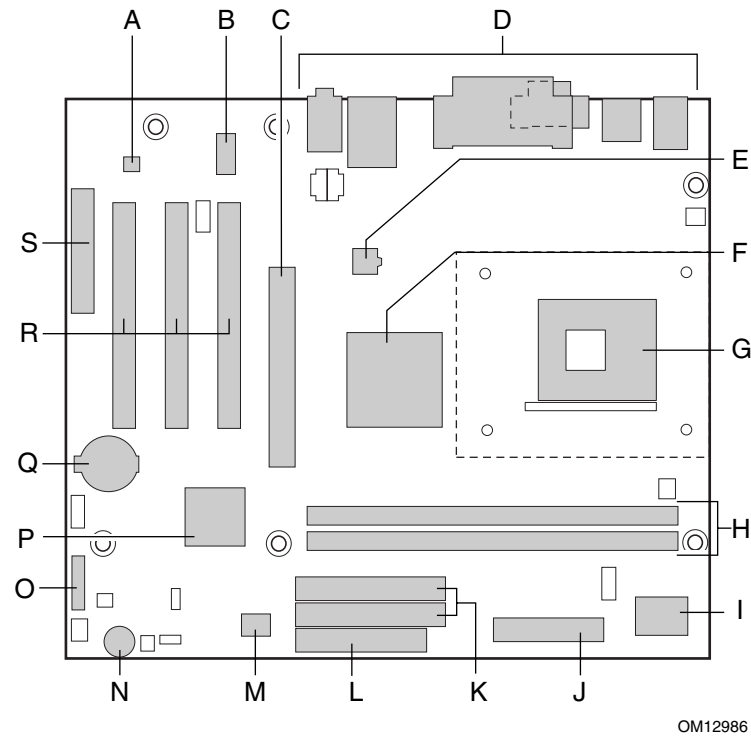

- | | | | |
|---|---|---|---|
| A | Audio codec | K | IDE connectors |
| B | Intel 82562ET PLC device (optional) | L | Diskette drive connector |
| C | AGP connector | M | Intel 82802AB 4 Mbit Firmware Hub (FWH) |
| D | Back panel connectors | N | Speaker |
| E | +12 V power connector (ATX12V) | O | Front panel connector |
| F | Intel 82845 Memory Controller Hub (MCH) | P | Intel 82801BA I/O Controller Hub (ICH2) |
| G | μ PGA478 processor socket | Q | Battery |
| H | DIMM sockets | R | PCI bus add-in card connectors |
| I | I/O controller | S | CNR connector (optional) |
| J | Power connector | | |

Figure 2. D845PT Board Components

1.2.4 Block Diagram

Figure 3 is a block diagram of the major functional areas of the standard D845BG and D845PT boards. See Figure 6 on page 27 for USB port routing.

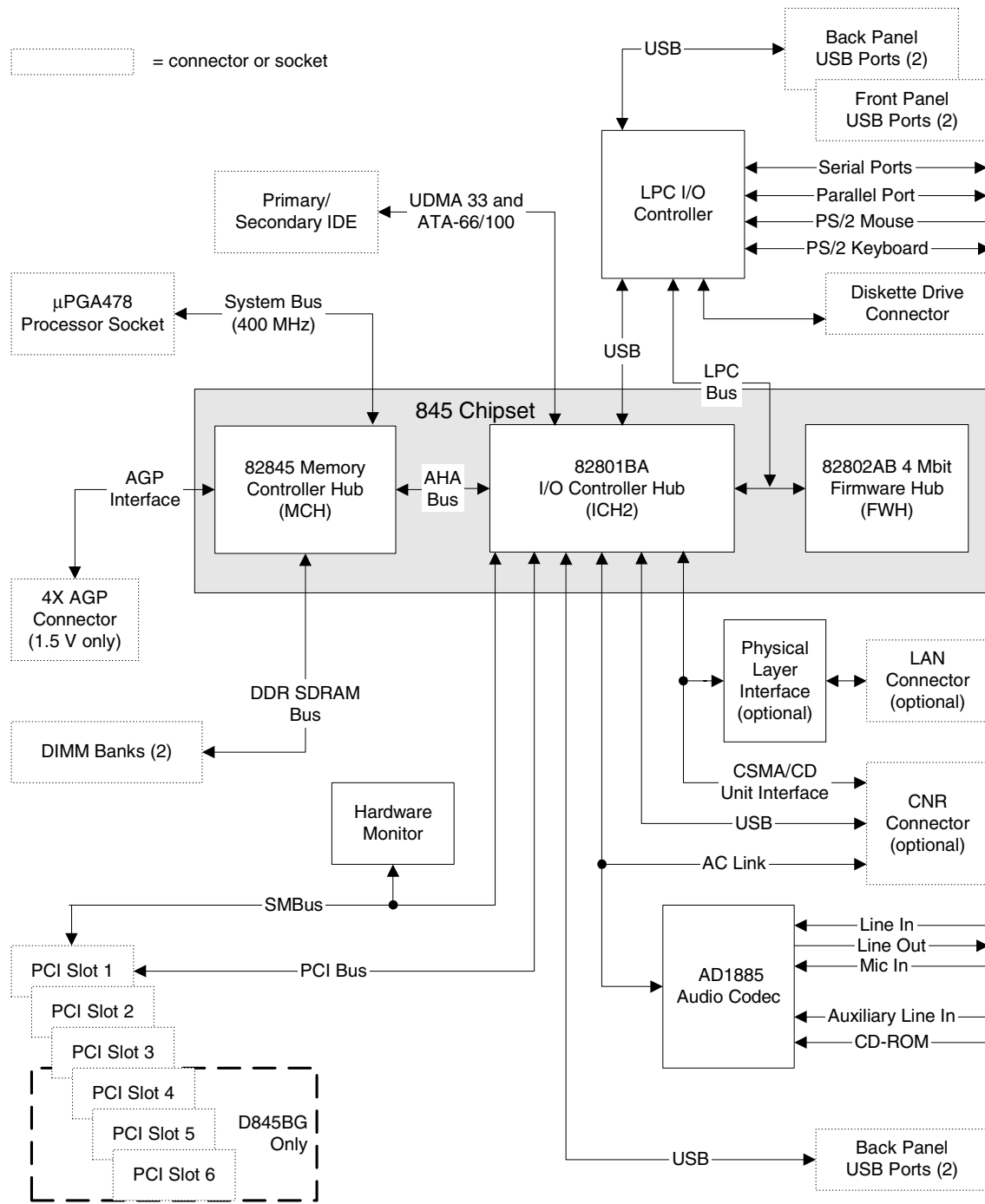

OM13008

Figure 3. Block Diagram

Figure 4 is a block diagram of the major functional areas of the D845BG board with the USB 2.0 manufacturing option. See Figure 7 on page 28 for USB port routing.

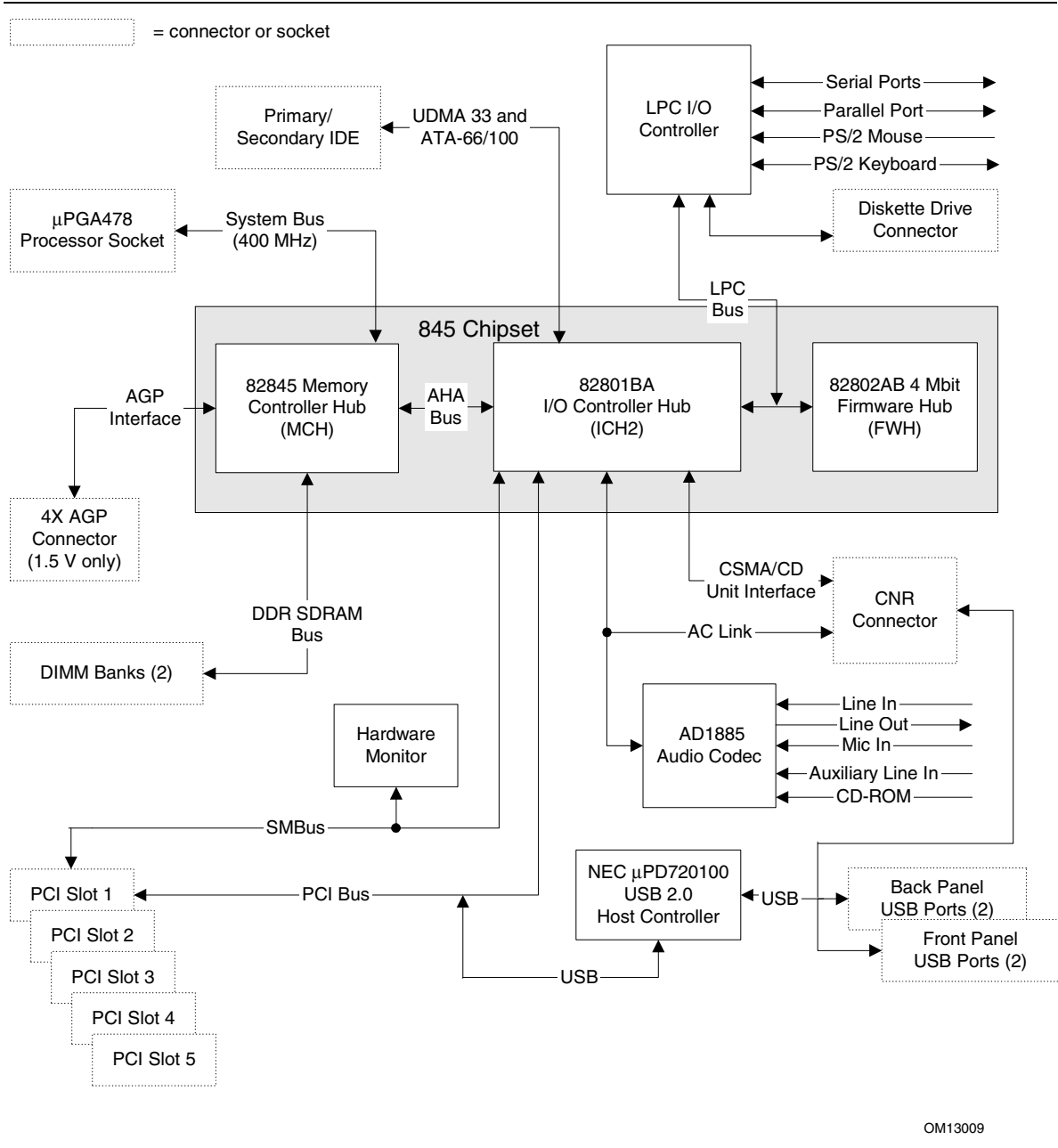

Figure 4. Block Diagram with Optional USB 2.0 Support

1.3 Online Support

To find information about...	Visit this World Wide Web site:
Intel's D845BG and D845PT boards under "Product Info" or "Customer Support"	http://www.intel.com/design/motherbd http://support.intel.com/support/motherboards/desktop
Available configurations for the D845BG board	http://developer.intel.com/design/motherbd/bg/bg_available.htm
Available configurations for the D845PT board	http://developer.intel.com/design/motherbd/pt/pt_available.htm
Processor data sheets	http://www.intel.com/design/litcentr
ICH2 addressing	http://developer.intel.com/design/chipsets/datashts
Custom splash screens	http://intel.com/design/motherbd/gen_indx.htm
Audio software and utilities	http://www.intel.com/design/motherbd
LAN software and drivers	http://www.intel.com/design/motherbd

1.4 Operating System Support

The D845BG and D845PT boards support drivers for all of the onboard hardware and subsystems under the following operating systems:

- Microsoft Windows† 98 SE
- Windows ME
- Windows NT† 4.0
- Windows 2000
- Windows XP

For information about	Refer to
Supported drivers	Section 1.3

NOTE

Third party vendors may offer other drivers.

NOTE

The USB 2.0 option requires an operating system that officially supports USB 2.0. USB 2.0 support has been tested with Windows 2000 and Windows XP drivers and is not currently supported by any other operating system.

1.5 Design Specifications

Table 4 lists the specifications applicable to the D845BG and D845PT boards.

Table 4. Specifications

Reference Name	Specification Title	Version, Revision Date, and Ownership	The information is available from...
AC '97	<i>Audio Codec '97</i>	Revision 2.2, September 2000, Intel Corporation.	ftp://download.intel.com/ial/scalableplatforms/ac97r22.pdf
ACPI	<i>Advanced Configuration and Power Interface Specification</i>	Version 2.0, July 27, 2000, Compaq Computer Corporation, Intel Corporation, Microsoft Corporation, Phoenix Technologies Limited, and Toshiba Corporation.	http://www.acpi.info/spec.htm
AGP	<i>Accelerated Graphics Port Interface Specification</i>	Revision 2.0, May 4, 1998, Intel Corporation.	http://www.agpforum.org/specs_specs.htm
AMI BIOS	<i>AMIBIOS Desktop Core 7.0</i>	AMIBIOS 7.0, August 8, 2001, American Megatrends, Inc.	http://www.ami.com/support/doc/amibiosdesktop.pdf
ATA/ ATAPI-5	<i>Information Technology-AT Attachment with Packet Interface - 5 (ATA/ATAPI-5)</i>	Revision 3, February 29, 2000, Contact: T13 Chair, Seagate Technology.	http://www.t13.org
ATX	<i>ATX Specification</i>	Version 2.03, December 1998, Intel Corporation.	http://www.formfactors.org/developer/specs/atx/atxspece.htm
ATX12V	<i>ATX/ATX12V Power Supply Design Guide</i>	Version 1.1, August 2000, Intel Corporation.	http://www.formfactors.org/developer/specs/atx/atxspece.htm
BIS	Boot Integrity Services	Version 1.0 for WfM 2.0 August 1999, Intel Corporation.	http://developer.intel.com/design/security/bis/bisfaq.htm
CNR	<i>Communication and Network Riser (CNR) Specification</i>	Revision 1.1, October 18, 2000, Intel Corporation.	http://developer.intel.com/technology/cnr/index.htm

continued

Table 4. Specifications (continued)

Reference Name	Specification Title	Version, Revision Date and Ownership	The information is available from...
DDR SDRAM	<i>Double Data Rate (DDR) SDRAM Specification</i>	Version 1.0, June 2000, JEDEC Solid State Technology Association.	http://www.jedec.org/
	<i>Design Specification for a 184 Pin DDR Unbuffered DIMM</i>	Revision 1.0, June 2000, JEDEC Solid State Technology Association.	http://www.jedec.org/
	<i>Intel® JEDEC DDR 200/266 Unbuffered DIMM Specification Addendum</i>	Revision 0.9, September 27, 2001, Intel Corporation.	http://developer.intel.com/technology/memory/index.htm
EHCI	<i>Enhanced Host Controller Interface Specification for Universal Serial Bus</i>	Revision 0.96, June 20, 2001, Intel Corporation.	http://developer.intel.com/technology/usb/ehcispec.htm
EPP	<i>IEEE Std 1284.1-1997 (Enhanced Parallel Port)</i>	Version 1.7, 1997, Institute of Electrical and Electronic Engineers.	http://standards.ieee.org/reading/ieee/std_public/description/busarch/1284.1-1997_desc.html
EI Torito	<i>Bootable CD-ROM Format Specification</i>	Version 1.0, January 25, 1995, Phoenix Technologies Limited and International Business Machines Corporation.	http://www.phoenix.com/PlatSS/products/specs.html
Front Panel	<i>Front Panel I/O Connectivity Design Guide</i>	Version 1.0, October 2000, Intel Corporation.	http://www.formfactors.org/formfactors/front_panel_io.htm
LPC	<i>Low Pin Count Interface Specification</i>	Revision 1.0, September 29, 1997, Intel Corporation.	http://www.intel.com/design/chipsets/industry/lpc.htm
MicroATX	<i>microATX Motherboard Interface Specification</i>	Version 1.0, December 1997, Intel Corporation.	http://www.formfactors.org/developer/specs/microatx/microatxspecs.htm
OHCI	<i>OpenHCI – Open Host Controller Interface Specification for USB</i>	Release 1.0a, October 10, 1996, Compaq Computer Corp., Microsoft Corporation, and National Semiconductor Corp.	http://www.usb.org/developers/docs.html
PCI	<i>PCI Local Bus Specification</i>	Revision 2.2, December 18, 1998, PCI Special Interest Group.	http://www.pcisig.com/specifications
	<i>PCI Bus Power Management Interface Specification</i>	Revision 1.1, December 18, 1998, PCI Special Interest Group.	http://www.pcisig.com/specifications

continued

Table 4. Specifications (continued)

Reference Name	Specification Title	Version, Revision Date and Ownership	The information is available from...
Plug and Play	<i>Plug and Play BIOS Specification</i>	Version 1.0a, May 5, 1994, Compaq Computer Corporation, Phoenix Technologies Limited, and Intel Corporation.	http://www.microsoft.com/hwdev/respec/pnpspecs.htm
PXE	<i>Preboot Execution Environment</i>	Version 2.1, September 20, 1999, Intel Corporation.	ftp://download.intel.com/ial/wfm/pxespec.pdf
SFX	<i>SFX/SFX12V Power Supply Design Guide</i>	Version 2.0, May 2001, Intel Corporation.	http://www.formfactors.org/developer/specs/sfx/sfx12v.pdf
SMBIOS	<i>System Management BIOS</i>	Version 2.3.1, March 16, 1999, American Megatrends Incorporated, Award Software International Incorporated, Compaq Computer Corporation, Dell Computer Corporation, Hewlett-Packard Company, Intel Corporation, International Business Machines Corporation, Phoenix Technologies Limited, and SystemSoft Corporation.	http://www.dmtf.org/download/standards/DSP0119.pdf
UHCI	<i>Universal Host Controller Interface Design Guide</i>	Revision 1.1, March 1996, Intel Corporation.	http://www.usb.org/developers/docs.html
USB	<i>Universal Serial Bus Specification</i>	Revision 1.1, September 23, 1998, Compaq Computer Corporation, Intel Corporation, Microsoft Corporation, and NEC Corporation.	http://www.usb.org/developers/docs.html
		Revision 2.0, April 27, 2000, Compaq Computer Corporation, Hewlett-Packard Company, Lucent Technologies Inc., Intel Corporation, Microsoft Corporation, NEC Corporation, and Koninklijke Philips Electronics N.V.	http://www.usb.org/developers/docs.html
WfM	<i>Wired for Management Baseline</i>	Version 2.0, December 18, 1998, Intel Corporation.	http://developer.intel.com/ial/WfM/wfmspecs.htm

1.6 Processor



CAUTION

Use only the processors listed below. Use of unsupported processors can damage the board, the processor, and the power supply. See the Intel® Desktop Board D845BG/D845PT Specification Update for the most up-to-date list of supported processors for these boards.

The D845BG and D845PT boards support a single Pentium 4 processor (in a μ PGA478 socket) with a system bus of 400 MHz. The D845BG and D845PT boards support the processors listed in Table 5. All supported onboard memory can be cached, up to the cachability limit of the processor. See the processor's data sheet for cachability limits.

Table 5. Supported Processors

Type	Designation	System Bus	L2 Cache Size
Pentium 4 processor	1.5, 1.6, 1.7, 1.8, 1.9, and 2.0 GHz	400 MHz	256 KB



NOTE

Use only ATX12V- or SFX12V-compliant power supplies with the D845BG and D845PT boards. ATX12V and SFX12V power supplies have an additional power lead that provides required supplemental power for the Intel Pentium 4 processor. Always connect the 20-pin and 4-pin leads of ATX12V and SFX12V power supplies to the corresponding connectors on the D845BG and D845PT boards, otherwise the board will not boot.

Do not use a standard ATX power supply. The board will not boot with a standard ATX power supply.

For information about	Refer to
Processor support	Section 1.3, page 18
Processor usage	Section 1.3, page 18
Power supply connectors	Section 2.8.2.3, page 61

1.7 System Memory

NOTE

Remove the AGP video card before installing or upgrading memory to avoid interference with the memory retention mechanism.

NOTE

The D845BG/D845PT boards have been designed to support DIMMs based on 512 Mbit technology for a maximum onboard capacity of up to 2 GB, but this technology has not been validated on this board. Please refer to the following Intel web sites for the latest lists of tested memory.

For the D845BG board:

http://developer.intel.com/design/motherbd/bg/bg_mem.htm

For the D845PT board:

http://developer.intel.com/design/motherbd/pt/pt_mem.htm

The D845BG and D845PT boards both have two DIMM sockets and support the following memory features:

- 2.5 V (only) 184-pin DDR SDRAM DIMMs with gold-plated contacts
- Unbuffered single-sided or double-sided DIMMs
- Maximum total system memory: 2 GB; minimum total system memory: 64 MB
- 200/266 MHz DDR SDRAM DIMMs only
- Serial Presence Detect (SPD)
- Suspend to RAM
- Non-ECC and ECC DIMMs

NOTE

To be fully compliant with all applicable DDR SDRAM memory specifications, the board should be populated with DIMMs that support the Serial Presence Detect (SPD) data structure. This allows the BIOS to read the SPD data and program the chipset to accurately configure memory settings for optimum performance. If non-SPD memory is installed, the BIOS will attempt to correctly configure the memory settings, but performance and reliability may be impacted or the DIMMs may not function under the determined frequency.

NOTE

For ECC functionality, all installed DIMMs must be ECC. If both ECC and non-ECC DIMMs are used, ECC will not function.

For information about

Obtaining DDR SDRAM specifications

Refer to

Section 1.5, page 19

Table 6 lists the supported DIMM configurations.

Table 6. Supported Memory Configurations

DIMM Capacity	Number of Sides	DDR SDRAM Density	DDR SDRAM Organization Front-side/Back-side	Number of DDR SDRAM Devices
64 MB	SS	64 Mbit	8 M x 8/empty	8
64 MB	SS	128 Mbit	8 M x 16/empty	4
96 MB	DS	64 Mbit	8 M x 8/4 M x 16	12 (Notes 1 and 2)
96 MB	DS	128/64 Mbit	8 M x 16/4 M x 16	8 (Notes 1 and 2)
128 MB	DS	64 Mbit	8 M x 8/8 M x 8	16 (Note 1)
128 MB	DS	128 Mbit	8 M x 16/8 M x 16	8 (Notes 1 and 2)
128 MB	SS	128 Mbit	16 M x 8/empty	8
128 MB	SS	256 Mbit	16 M x 16/empty	4
192 MB	DS	128 Mbit	16 M x 8/8 M x 16	12 (Notes 1 and 2)
192 MB	DS	128/64 Mbit	16 M x 8/8 M x 8	16 (Notes 1 and 2)
256 MB	DS	128 Mbit	16 M x 8/16 M x 8	16 (Notes 1 and 2)
256 MB	DS	256 Mbit	16 M x 16/16 M x 16	8 (Notes 1 and 2)
256 MB	SS	256 Mbit	32 M x 8/empty	8
512 MB	DS	256 Mbit	32 M x 8/32 M x 8	16 (Notes 1 and 2)

Notes:

1. If the number of DDR SDRAM devices is greater than nine, the DIMM will be double sided.
2. Front side population/back side population indicated for DDR SDRAM density and DDR SDRAM organization.
3. In the second column, "DS" refers to double-sided memory modules (containing two rows of DDR SDRAM) and "SS" refers to single-sided memory modules (containing one row of DDR SDRAM).

1.8 Intel® 845 Chipset

The Intel 845 chipset consists of the following devices:

- Intel 82845 Memory Controller Hub (MCH) with Accelerated Hub Architecture (AHA) bus
- Intel 82801BA I/O Controller Hub (ICH2) with AHA bus
- Intel 82802AB Firmware Hub (FWH)

The MCH is a centralized controller for the system bus, the memory bus, the AGP bus, and the Accelerated Hub Architecture interface. The ICH2 is a centralized controller for the board's I/O paths. The FWH provides the nonvolatile storage of the BIOS. The component combination provides the chipset interfaces as shown in Figure 5.

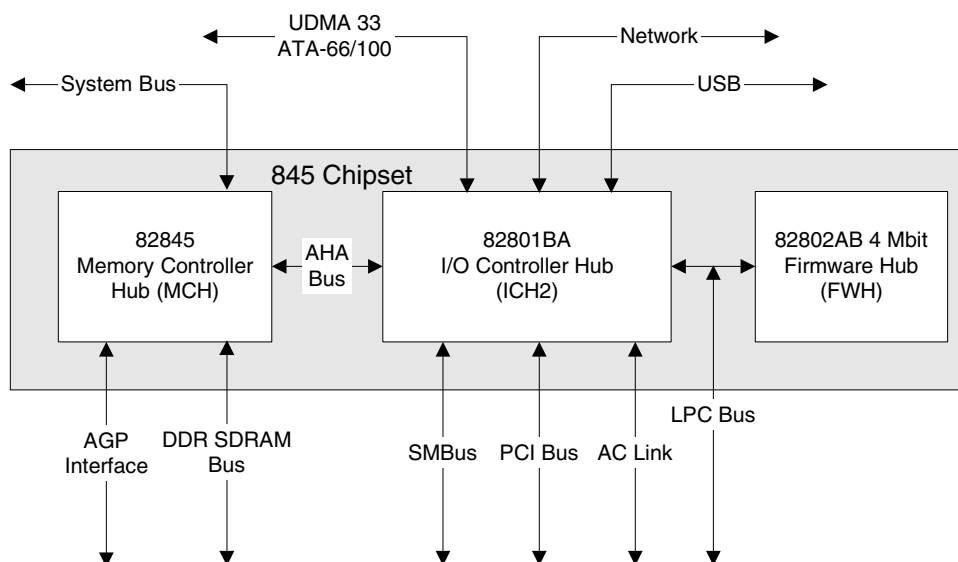

OM13069

Figure 5. Intel 845 Chipset Block Diagram

NOTE

The USB bus is routed from the NEC USB 2.0 controller if the USB 2.0 option is supported.

For information about

The Intel 845 chipset

Resources used by the chipset

Refer to

<http://developer.intel.com>

Chapter 2

1.8.1 AGP

NOTE

The AGP connector is keyed for 1.5 V AGP cards only. Do not attempt to install a legacy 3.3 V AGP card. The AGP connector is not mechanically compatible with legacy 3.3 V AGP cards.

The AGP connector supports AGP add-in cards with 1.5 V Switching Voltage Level (SVL). Legacy 3.3 V AGP cards are not supported.

For information about	Refer to
The location of the AGP connector	Figure 1, page 14
The signal names of the AGP connector	Table 36, page 68

AGP is a high-performance interface for graphics-intensive applications, such as 3D applications. While based on the *PCI Local Bus Specification*, Rev. 2.2, AGP is independent of the PCI bus and is intended for exclusive use with graphical display devices. AGP overcomes certain limitations of the PCI bus related to handling large amounts of graphics data with the following features:

- Pipelined memory read and write operations that hide memory access latency
- Demultiplexing of address and data on the bus for nearly 100 percent efficiency

For information about	Refer to
Obtaining the <i>Accelerated Graphics Port Interface Specification</i>	Section 1.5, page 19

1.8.2 USB

The following sections describe the USB port configurations implemented on the D845BG/D845PT boards.

NOTE

Computer systems that have an unshielded cable attached to a USB port may not meet FCC Class B requirements, even if no device is attached to the cable. Use shielded cable that meets the requirements for full-speed devices.

For information about	Refer to
The location of the USB connectors on the back panel	Figure 11, page 55
The signal names of the back panel USB connectors	Table 19, page 56
The location of the front panel USB connector	Figure 16, page 71
The signal names of the front panel USB connector	Table 42, page 72
The front panel, UHCI, and USB specifications	Section 1.5, page 19

1.8.2.1 USB 1.1 Support

The D845BG/D845PT boards support up to seven USB ports, as shown in Figure 6. The ICH2 provides four ports, three of which are user-accessible:

- Two ports implemented with stacked back panel connectors, adjacent to the PS/2 connectors
- One port accessible through an optional CNR connector
- One port routed to the SMSC USB hub

The onboard SMSC USB hub provides four ports:

- Two ports implemented with stacked back panel connectors, adjacent to the audio connectors
- Two ports routed to the front panel USB connector

For more than seven USB devices, an external hub can be connected to any of the ports.

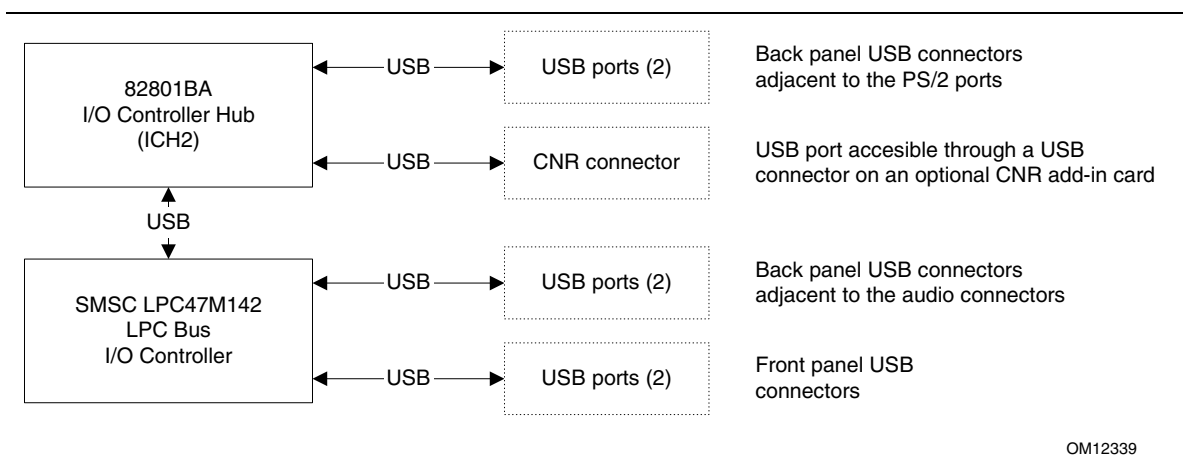

Figure 6. USB 1.1 Port Configuration

1.8.2.2 USB 2.0 Support (Optional)

NOTE

The USB 2.0 option is currently available only on the D845BG board. All D845BG boards with the NEC μ PD720100 USB 2.0 host controller have only five PCI bus connectors.

The D845BG board supports USB 2.0 using the NEC μ PD720100 USB 2.0 host controller, which is a manufacturing option. The port routing is implemented as shown in Figure 7. The NEC μ PD720100 controller is connected through the PCI bus and provides support for up to five USB ports:

- Two ports implemented with stacked back panel connectors, adjacent to the audio connectors
- Two ports routed to the front panel USB connector
- One port accessible through the CNR connector

For more than five USB devices, an external hub can be connected to any of the ports. D845BG boards with the USB 2.0 option fully support OHCI and EHCI and use OHCI- and EHCI-compatible drivers.

NOTE

The USB 2.0 option requires an operating system that officially supports USB 2.0. USB 2.0 support has been tested with Windows 2000 and Windows XP drivers and is not currently supported by any other operating system.

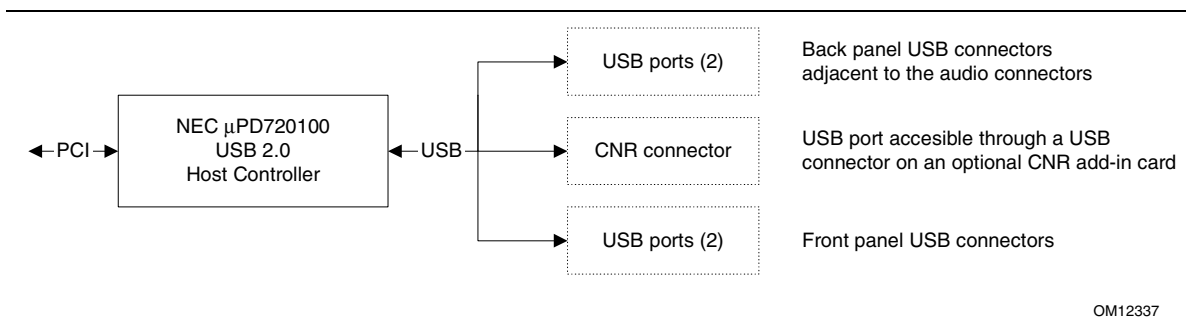

OM12337

Figure 7. USB 2.0 Port Configuration (Optional)

1.8.3 IDE Support

1.8.3.1 IDE Interfaces

The ICH2's IDE controller has two independent bus-mastering IDE interfaces that can be independently enabled. The IDE interfaces support the following modes:

- Programmed I/O (PIO): processor controls data transfer.
- 8237-style DMA: DMA offloads the processor, supporting transfer rates of up to 16 MB/sec.
- Ultra DMA: DMA protocol on IDE bus supporting host and target throttling and transfer rates of up to 33 MB/sec.
- ATA-66: DMA protocol on IDE bus supporting host and target throttling and transfer rates of up to 66 MB/sec. ATA-66 protocol is similar to Ultra DMA and is device driver compatible.
- ATA-100: DMA protocol on IDE bus allows host and target throttling. The ICH2's ATA-100 logic can achieve read transfer rates up to 100 MB/sec and write transfer rates up to 88 MB/sec.



NOTE

ATA-66 and ATA-100 are faster timings and require a specialized cable to reduce reflections, noise, and inductive coupling.

The IDE interfaces also support ATAPI devices (such as CD-ROM drives) and ATA devices using the transfer modes listed in Section 4.4.4.1 on page 109.

The BIOS supports Logical Block Addressing (LBA) and Extended Cylinder Head Sector (ECHS) translation modes. The drive reports the transfer rate and translation mode to the BIOS.

The D845BG and D845PT boards support Laser Servo (LS-120) diskette technology through the IDE interfaces. An LS-120 drive can be configured as a boot device by setting the BIOS Setup program's Boot menu to one of the following:

- ARMD-FDD (ATAPI removable media device – floppy disk drive)
- ARMD-HDD (ATAPI removable media device – hard disk drive)

For information about	Refer to
The location of the IDE connectors	Figure 14, page 64
The signal names of the IDE connectors	Table 38, page 70
BIOS Setup program's Boot menu	Table 74, page 117

1.8.3.2 SCSI Hard Drive Activity LED Connector

The SCSI hard drive activity LED connector is a 1 x 2-pin connector that allows an add-in SCSI controller to use the same LED as the onboard IDE controller. For proper operation, this connector should be wired to the LED output of the add-in SCSI controller. The LED indicates when data is being read from, or written to, both the add-in SCSI controller and the IDE controller.

For information about	Refer to
The location of the SCSI hard drive activity LED connector	Figure 14, page 64, or Figure 15, page 65
The signal names of the SCSI hard drive activity LED connector	Table 39, page 70

1.8.4 Real-Time Clock, CMOS SRAM, and Battery

The real-time clock provides a time-of-day clock and a multicentury calendar with alarm features. The real-time clock supports 256 bytes of battery-backed CMOS SRAM in two banks that are reserved for BIOS use.

A coin-cell battery (CR2032) powers the real-time clock and CMOS memory. When the computer is not plugged into a wall socket, the battery has an estimated life of three years. When the computer is plugged in, the standby current from the power supply extends the life of the battery. The clock is accurate to ± 13 minutes/year at 25 °C with 3.3 VSB applied.

The time, date, and CMOS values can be specified in the BIOS Setup program. The CMOS values can be returned to their defaults by using the BIOS Setup program.

NOTE

If the battery and AC power fail, custom defaults, if previously saved, will be loaded into CMOS RAM at power-on.

1.8.5 Intel® 82802AB 4 Mbit Firmware Hub (FWH)

The FWH provides the following:

- System BIOS program
- Logic that enables protection for storing and updating of platform information

1.9 I/O Controller

The SMSC LPC47M142 I/O controller provides the following features:

- Two serial ports
- One parallel port with Extended Capabilities Port (ECP) and Enhanced Parallel Port (EPP) support
- Serial IRQ interface compatible with serialized IRQ support for PCI systems
- PS/2-style mouse and keyboard interfaces
- Interface for one 1.2 MB or 1.44 MB diskette drive
- Intelligent power management, including a programmable wake-up event interface
- PCI power management support
- Two fan tachometer inputs
- Integrated USB hub

The BIOS Setup program provides configuration options for the I/O controller.

For information about

SMSC LPC47M142 I/O controller

Refer to

<http://www.smsc.com>

1.9.1 Serial Ports

The D845BG and D845PT boards have two serial port connectors. Serial port A is located on the back panel. Serial port B is accessible using a connector located near the main power connector. The serial ports' NS16C550-compatible UART supports data transfers at speeds up to 115.2 kbits/sec with BIOS support. The serial ports can be assigned as COM1 (3F8h), COM2 (2F8h), COM3 (3E8h), or COM4 (2E8h).

For information about	Refer to
The location of the serial port A connector	Figure 11, page 55
The signal names of the serial port A connector	Table 21, page 57
The location of the serial port B connector	Figure 16, page 71
The signal names of the serial port B connector	Table 41, page 72

1.9.2 Parallel Port

The 25-pin D-Sub parallel port connector is located on the back panel. In the BIOS Setup program, the parallel port can be set to the following modes:

- Output only (PC AT⁺-compatible mode)
- Bi-directional (PS/2 compatible)
- EPP
- ECP

For information about	Refer to
The location of the parallel port connector	Figure 11, page 55
The signal names of the parallel port connector	Table 20, page 56
Setting the parallel port's mode	Table 65, page 106

1.9.3 Diskette Drive Controller

The I/O controller supports one diskette drive that is compatible with the 82077 diskette drive controller and supports both PC-AT and PS/2 modes.

For information about	Refer to
The location of the diskette drive connector	Figure 14, page 64
The signal names of the diskette drive connector	Table 37, page 69
The supported diskette drive capacities and sizes	Table 68, page 111

1.9.4 Keyboard and Mouse Interface

PS/2 keyboard and mouse connectors are located on the back panel. The +5 V lines to these connectors are protected with a PolySwitch[†] circuit that, like a self-healing fuse, reestablishes the connection after an overcurrent condition is removed.

NOTE

The keyboard is supported in the bottom PS/2 connector and the mouse is supported in the top PS/2 connector. Power to the computer should be turned off before a keyboard or mouse is connected or disconnected.

The keyboard controller contains the AMI keyboard and mouse controller code, provides the keyboard and mouse control functions, and supports password protection for power-on/reset. A power-on/reset password can be specified in the BIOS Setup program.

For information about	Refer to
The location of the keyboard and mouse connectors	Figure 11, page 55
The signal names of the keyboard and mouse connectors	Table 18, page 56

1.10 Audio Subsystem

The audio subsystem includes these features:

- Split digital/analog architecture for improved S/N (signal-to-noise) ratio: ≥ 85 dB
- Power management support for ACPI 2.0 (driver dependant)
- Mic in pre-amp that supports dynamic, condenser, and electret microphones

The audio subsystem supports the following audio interfaces:

- ATAPI-style connectors:
 - Auxiliary line in
 - CD-ROM
- Front panel audio connector, including pins for:
 - Line out
 - Mic in
- Back panel audio connectors:
 - Line out
 - Line in
 - Mic in

The audio subsystem consists of the following devices:

- Intel 82801BA I/O Controller Hub (ICH2)
- Analog Devices AD1885 audio codec

Figure 8 is a block diagram of the audio subsystem.

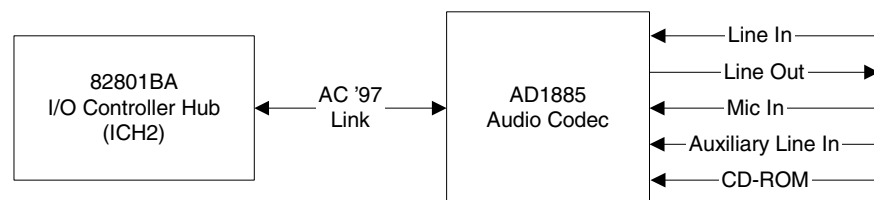

OM13010

Figure 8. Audio Subsystem Block Diagram

For information about	Refer to
Upgrading the onboard audio subsystem using a CNR audio card	Section 1.12, page 36
The front panel audio connector	Section 2.8.3, page 71
The back panel audio connectors	Section 2.8.1, page 55

1.10.1 Audio Connectors

1.10.1.1 Front Panel Audio Connector

A 2 x 5-pin connector provides mic in and line out signals for front panel audio connectors.

For information about	Refer to
The location of the connector	Section 2.8.3, page 71
The signal names of the front panel audio connector	Table 40, page 72
Obtaining the <i>Front Panel I/O Connectivity Design Guide</i>	Section 1.5, page 19

NOTE

The front panel audio connector is alternately used as a jumper block for routing audio signals. Refer to Section 2.9.1 on page 75 for more information.

1.10.1.2 Auxiliary Line In Connector

A 1 x 4-pin ATAPI-style connector connects the left and right channel signals of an internal audio device to the audio subsystem.

For information about	Refer to
The location of the auxiliary line in connector	Figure 12, page 59
The signal names of the auxiliary line in connector	Table 27, page 60

1.10.1.3 ATAPI CD-ROM Audio Connector

A 1 x 4-pin ATAPI-style connector connects an internal ATAPI CD-ROM drive to the audio mixer.

For information about	Refer to
The location of the ATAPI CD-ROM connector	Figure 12, page 59
The signal names of the ATAPI CD-ROM connector	Table 27, page 60

1.10.2 Audio Subsystem Software

Audio software and drivers are available from Intel's World Wide Web site.

For information about	Refer to
Obtaining audio software and drivers	Section 1.3, page 18

1.11 LAN Subsystem (Optional)

The Network Interface Controller subsystem consists of the ICH2 (with integrated LAN Media Access Controller) and a physical layer interface device. Features of the LAN subsystem include:

- PCI Bus Master interface
- CSMA/CD Protocol Engine
- Serial CSMA/CD unit interface that supports the 82562ET (10/100 Mbit/sec Ethernet) on the CNR bus
- PCI Power Management
 - Supports ACPI technology
 - Supports LAN wake capabilities

1.11.1 Intel® 82562ET Platform LAN Connect Device

The Intel 82562ET component provides an interface to the back panel RJ-45 connector with integrated LEDs. This physical interface may alternately be provided through the CNR connector.

The Intel 82562ET provides the following functions:

- Basic 10/100 Ethernet LAN connectivity
- Supports RJ-45 connector with status indicator LEDs on the back panel
- Full device driver compatibility
- ACPI support
- Programmable transit threshold
- Configuration EEPROM that contains the MAC address

1.11.2 RJ-45 LAN Connector with Integrated LEDs

Two LEDs are built into the RJ-45 LAN connector. Table 7 describes the LED states when the board is powered up and the LAN subsystem is operating.

Table 7. LAN Connector LED States

LED Color	LED State	Condition
Green	Off	10 Mbit/sec data rate is selected.
	On	100 Mbit/sec data rate is selected.
Yellow	Off	LAN link is not established.
	On (steady state)	LAN link is established.
	On (brighter and pulsing)	The computer is communicating with another computer on the LAN.

1.11.3 LAN Subsystem Software

LAN software and drivers are available from Intel's World Wide Web site.

For information about	Refer to
Obtaining LAN software and drivers	Section 1.3, page 18

1.12 CNR (Optional)

The CNR connector provides an interface that supports the audio, modem, USB, and LAN interfaces of the Intel 845 chipset. Figure 9 shows the signal interface between the riser and the ICH2.

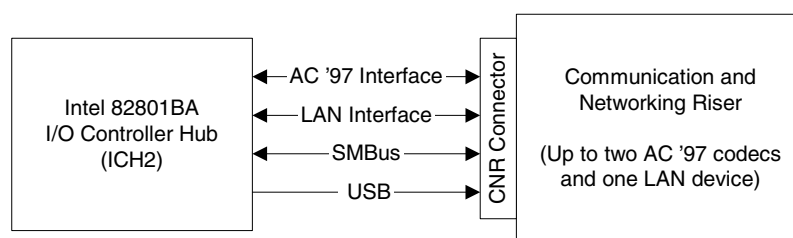

OM12277

Figure 9. ICH2 and CNR Signal Interface

NOTE

The USB bus is routed from the NEC USB 2.0 controller if the USB 2.0 option is supported.

The interfaces supported by the CNR include the following:

- AC '97 interface: supports audio and/or modem functions on the CNR card.
- LAN interfaces: an eight-pin interface for use with Platform LAN Connection (PLC) based devices.
- SMBus interface: provides Plug-and-Play functionality for the CNR card.
- USB interface: provides a USB interface for the CNR card.

The CNR connector includes power signals required for power management and for CNR card operation. To learn more about the CNR, refer to the CNR specification.

The onboard two-channel audio subsystem can be upgraded to four- or six-channel audio using a CNR audio upgrade card in a slave configuration. CNR audio upgrade cards are available in multiple configurations from several different vendors supporting analog or S/P-DIF digital connections. A list of vendors supplying CNR audio upgrade cards compatible with the D845BG/D845PT boards' onboard audio subsystem, as well as an installation guide for these cards with SoundMAX with SPX are available on the following web site:

<http://developer.intel.com/technology/cnr/>

NOTE

If you install a CNR card that cannot support a multichannel audio upgrade, the D845BG and D845PT boards' integrated audio codec will be disabled. This only applies to D845BG and D845PT boards that have both the onboard audio subsystem and a CNR.

NOTE

The brand and type of audio codec used on the CNR card must match that of the D845BG/D845PT boards' codec (Analog Devices AD1885).

For information about	Refer to
Obtaining the CNR specification	Section 1.5, page 19

1.13 Hardware Management Subsystem

The hardware management features enable the boards to be compatible with the Wired for Management (WfM) specification. The board has several hardware management features, including the following:

- Fan monitoring
- Thermal and voltage monitoring
- Chassis intrusion detection

For information about	Refer to
The WfM specification	Section 1.5, page 19

1.13.1 Hardware Monitor Component

The hardware monitor component provides low-cost instrumentation capabilities. The features of the component include:

- Internal ambient temperature sensing
- Remote thermal diode sensing for direct monitoring of processor temperature
- Power supply monitoring (+5 V, +3.3 V, +1.5 V, 3.3 VSB, and Vccp) to detect levels above or below acceptable values
- SMBus interface

1.13.2 Fan Monitoring

The SMSC LPC47M142 I/O controller provides two fan tachometer inputs. Monitoring can be implemented using Intel® Active Monitor or third-party software.

For information about	Refer to
The functions of the fan connectors	Section 1.14.2.2, page 43
The location of the fan connectors	Figure 13, page 61
The signal names of the fan connectors	Section 2.8.2.3, page 61

1.13.3 Chassis Intrusion and Detection

The boards support a chassis security feature that detects if the chassis cover is removed. For the chassis intrusion circuit to function, the chassis' power supply must be connected to AC power. The security feature uses a mechanical switch on the chassis that attaches to the chassis intrusion connector. The mechanical switch is closed for normal computer operation.

For information about	Refer to
The location of the chassis intrusion connector	Figure 13, page 61
The signal names of the chassis intrusion connector	Table 33, page 63

NOTE

Chassis intrusion detection may be implemented using Intel Active Monitor or third-party software.

1.14 Power Management

Power management is implemented at several levels, including:

- Software support through Advanced Configuration and Power Interface (ACPI)
- Hardware support:
 - Power connector
 - Fan connectors
 - LAN wake capabilities
 - Instantly Available PC technology
 - Resume on Ring
 - Wake from USB
 - Wake from PS/2 devices
 - Power Management Event (PME#) wake-up support

1.14.1 ACPI

ACPI gives the operating system direct control over the power management and Plug and Play functions of a computer. The use of ACPI with the D845BG and D845PT boards requires an operating system that provides full ACPI support. ACPI features include:

- Plug and Play (including bus and device enumeration)
- Power management control of individual devices, add-in boards (some add-in boards may require an ACPI-aware driver), video displays, and hard disk drives
- Methods for achieving less than 15-watt system operation in the power-on/standby sleeping state
- A Soft-off feature that enables the operating system to power-off the computer
- Support for multiple wake-up events (see Table 10 on page 41)
- Support for a front panel power and sleep mode switch

Table 8 lists the system states based on how long the power switch is pressed, depending on how ACPI is configured with an ACPI-aware operating system.

Table 8. Effects of Pressing the Power Switch

If the system is in this state...	...and the power switch is pressed for	...the system enters this state
Off (ACPI G2/G5 – Soft off)	Less than four seconds	Power-on (ACPI G0 – working state)
On (ACPI G0 – working state)	Less than four seconds	Soft-off/Standby (ACPI G1 – sleeping state)
On (ACPI G0 – working state)	More than four seconds	Fail safe power-off (ACPI G2/G5 – Soft off)
Sleep (ACPI G1 – sleeping state)	Less than four seconds	Wake-up (ACPI G0 – working state)
Sleep (ACPI G1 – sleeping state)	More than four seconds	Power-off (ACPI G2/G5 – Soft off)

For information about

The D845BG and D845PT boards' compliance level with ACPI

Refer to

Section 1.5, page 19

1.14.1.1 System States and Power States

Under ACPI, the operating system directs all system and device power state transitions. The operating system puts devices in and out of low-power states based on user preferences and knowledge of how devices are being used by applications. Devices that are not being used can be turned off. The operating system uses information from applications and user settings to put the system as a whole into a low-power state.

Table 9 lists the power states supported by the D845BG and D845PT boards along with the associated system power targets. See the ACPI specification for a complete description of the various system and power states.

Table 9. Power States and Targeted System Power

Global States	Sleeping States	Processor States	Device States	Targeted System Power (Note 1)
G0 – working state	S0 – working	C0 – working	D0 – working state.	Full power > 30 W
G1 – sleeping state	S1 – Processor stopped	C1 – stop grant	D1, D2, D3 – device specification specific.	5 W < power < 52.5 W
G1 – sleeping state	S3 – Suspend to RAM. Context saved to RAM.	No power	D3 – no power except for wake-up logic.	Power < 5 W (Note 2)
G1 – sleeping state	S4 – Suspend to disk. Context saved to disk.	No power	D3 – no power except for wake-up logic.	Power < 5 W (Note 2)
G2/S5	S5 – Soft off. Context not saved. Cold boot is required.	No power	D3 – no power except for wake-up logic.	Power < 5 W (Note 2)
G3 – mechanical off AC power is disconnected from the computer.	No power to the system.	No power	D3 – no power for wake-up logic, except when provided by battery or external source.	No power to the system. Service can be performed safely.

Notes:

1. Total system power is dependent on the system configuration, including add-in boards and peripherals powered by the system chassis' power supply.
2. Dependent on the standby power consumption of wake-up devices used in the system.

1.14.1.2 Wake-up Devices and Events

Table 10 lists the devices or specific events that can wake the computer from specific states.

Table 10. Wake-up Devices and Events

These devices/events can wake up the computer...	...from this state
Power switch	S1, S3, S4, S5
RTC alarm	S1, S3, S4, S5
LAN	S1, S3, S4, S5 (Note 1)
CNR	S1, S3, S4 (Note 2), S5 (Note 2)
PME#	S1, S3, S4, S5
Modem (back panel Serial Port A)	S1, S3
USB	S1, S3
PS/2 devices	S1, S3

Notes:

1. For LAN and PME#, S5 is disabled by default in the BIOS Setup program. Setting this option to Power On will enable a wake-up event from LAN in the S5 state.
2. Except from the CNR's USB interface.

NOTE

The use of these wake-up events from an ACPI state requires an operating system that provides full ACPI support. In addition, software, drivers, and peripherals must fully support ACPI wake events.

1.14.1.3 Plug and Play

In addition to power management, ACPI provides control information so that operating systems can facilitate Plug and Play. ACPI is used only to configure devices that do not use other hardware configuration standards. PCI devices for example, are not configured by ACPI.

1.14.2 Hardware Support



CAUTION

Ensure that the power supply provides adequate +5 V standby current if LAN wake capabilities and Instantly Available PC technology features are used. Failure to do so can damage the power supply. The total amount of standby current required depends on the wake devices supported and manufacturing options. Refer to Section 2.11.3 on page 83 for additional information.

The D845BG and D845PT boards provide several power management hardware features, including:

- Power connector
- Fan connectors
- LAN wake capabilities
- Instantly Available PC technology
- Resume on Ring
- Wake from USB
- Wake from PS/2 keyboard
- PME# wake-up support

LAN wake capabilities and Instantly Available PC technology require power from the +5 V standby line. The sections discussing these features describe the incremental standby power requirements for each.

Resume on Ring enables telephony devices to access the computer when it is in a power-managed state. The method used depends on the type of telephony device (external or internal).



NOTE

The use of Resume on Ring and Wake from USB technologies from an ACPI state requires an operating system that provides full ACPI support.

1.14.2.1 Power Connector

When used with an ATX12V- or SFX12V-compliant power supply that supports remote power on/off, the D845BG and D845PT boards can turn off the system power through software control. When the system BIOS receives the correct command from the operating system, the BIOS turns off power to the computer.

With soft-off enabled, if power to the computer is interrupted by a power outage or a disconnected power cord, when power resumes, the computer returns to the power state it was in before power was interrupted (on or off). The computer's response can be set using the After Power Failure feature in the BIOS Setup program's Boot menu.

For information about	Refer to
The location of the power connector	Figure 13, page 61
The signal names of the power connector	Table 31, page 63
The BIOS Setup program's Boot menu	Table 74, page 117
The ATX and SFX specifications	Section 1.5, page 19

1.14.2.2 Fan Connectors

Table 11 summarizes the function/operation of the fan connectors.

Table 11. Fan Connector Function/Operation

Connector	Description
Processor fan	<ul style="list-style-type: none"> +12 V DC connection for a processor fan or active fan heatsink. Fan is on in the S0 or S1 state. Fan is off when the system is off or in the S3, S4, or S5 state. Wired to a fan tachometer input of the SMSC LPC47M142 I/O controller.
Front chassis fan	<ul style="list-style-type: none"> +12 V DC connection for a system or chassis fan. Fan is on in the S0 or S1 state. Fan is off when the system is off or in the S3, S4, or S5 state. Wired to a fan tachometer input of the SMSC LPC47M142 I/O controller.
Rear chassis fan	<ul style="list-style-type: none"> +12 V DC connection for a system or chassis fan. Fan is on in the S0 or S1 state. Fan is off when the system is off or in the S3, S4, or S5 state.

For information about	Refer to
The location of the fan connectors	Figure 13, page 61
The signal names of the fan connectors	Section 2.8.2.3, page 61

1.14.2.3 LAN Wake Capabilities



CAUTION

For LAN wake capabilities, the 5-V standby line for the power supply must be capable of providing adequate +5 V standby current. Failure to provide adequate standby current when implementing LAN wake capabilities can damage the power supply. Refer to Section 2.11.3 on page 83 for additional information.

LAN wake capabilities enable remote wake-up of the computer through a network. The LAN subsystem PCI bus network adapter monitors network traffic at the Media Independent Interface. Upon detecting a Magic Packet[†] frame, the LAN subsystem asserts a wake-up signal that powers up the computer. Depending on the LAN implementation, the D845BG and D845PT boards support LAN wake capabilities with ACPI in the following ways:

- the PCI bus PME# signal for PCI 2.2 compliant LAN designs
- the onboard LAN subsystem
- a CNR-based LAN subsystem

1.14.2.4 Instantly Available PC Technology



CAUTION

For Instantly Available PC technology, the +5 V standby line for the power supply must be capable of providing adequate +5 V standby current. Failure to provide adequate standby current when implementing Instantly Available PC technology can damage the power supply. Refer to Section 2.11.3 on page 83 for additional information.

Instantly Available PC technology enables the D845BG and D845PT boards to enter the ACPI S3 (Suspend-to-RAM) sleep-state. While in the S3 sleep-state, the computer will appear to be off (the power supply is off, and the front panel LED is amber if dual colored, or off if single colored.) When signaled by a wake-up device or event, the system quickly returns to its last known wake state. Table 10 on page 41 lists the devices and events that can wake the computer from the S3 state.

The D845BG and D845PT boards support the *PCI Bus Power Management Interface Specification*. For information on the versions of this specification, see Section 1.5. Add-in boards that also support this specification can participate in power management and can be used to wake the computer.

The use of Instantly Available PC technology requires operating system support and PCI 2.2 compliant add-in cards and drivers.

The standby power indicator LED shows that power is still present even when the computer appears to be off. Figure 10 shows the location of the standby power indicator LED.



CAUTION

If AC power has been switched off and the standby power indicator is still lit, disconnect the power cord before installing or removing any devices connected to the board. Failure to do so could damage the board and any attached devices.

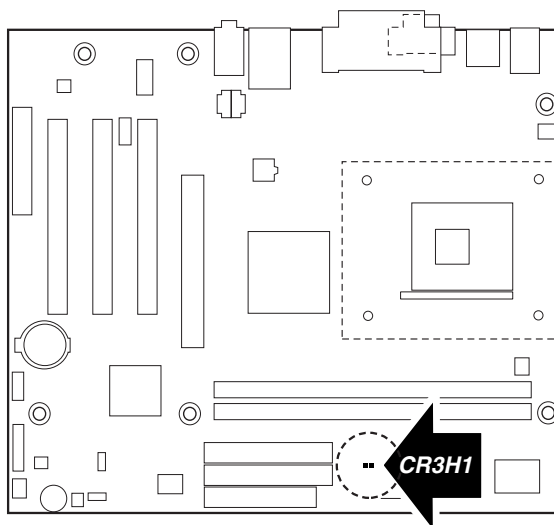

OM12987

Figure 10. Location of the Standby Power Indicator LED

1.14.2.5 Resume on Ring

The operation of Resume on Ring can be summarized as follows:

- Resumes operation from ACPI S1 or S3 states
- Requires only one call to access the computer
- Detects incoming call similarly for external and internal modems
- Requires modem interrupt be unmasked for correct operation

1.14.2.6 Wake from USB

USB bus activity wakes the computer from an ACPI S1 or S3 state.

NOTE

Wake from USB requires the use of a USB peripheral that supports Wake from USB.

1.14.2.7 Wake from PS/2 Devices

PS/2 device activity wakes the computer from an ACPI S1 or S3 state.

1.14.2.8 PME# Wake-up Support

When the PME# signal on the PCI bus is asserted, the computer wakes from an ACPI S1, S3, S4, or S5 state (with Wake on PME enabled in BIOS).

2 Technical Reference

What This Chapter Contains

2.1	Introduction.....	47
2.2	Memory Map	47
2.3	I/O Map	48
2.4	DMA Channels	50
2.5	PCI Configuration Space Map	50
2.6	Interrupts	51
2.7	PCI Interrupt Routing Map.....	52
2.8	Connectors.....	54
2.9	Jumper Blocks.....	75
2.10	Mechanical Considerations.....	77
2.11	Electrical Considerations	82
2.12	Thermal Considerations.....	85
2.13	Reliability	87
2.14	Environmental	87
2.15	Regulatory Compliance	88

2.1 Introduction

Sections 2.2 - 2.6 contain several standalone tables. Table 12 describes the system memory map, Table 13 shows the I/O map, Table 14 lists the DMA channels, Table 15 defines the PCI configuration space map, and Table 16 describes the interrupts. The remaining sections in this chapter are introduced by text found with their respective section headings.

2.2 Memory Map

Table 12. System Memory Map

Address Range (decimal)	Address Range (hex)	Size	Description
1024 K - 2097152 K	100000 - 7FFFFFFF	2047 MB	Extended memory
960 K - 1024 K	F0000 - FFFFF	64 KB	Runtime BIOS
896 K - 960 K	E0000 - EFFFF	64 KB	Reserved
800 K - 896 K	C8000 - DFFFF	96 KB	Available high DOS memory (open to the PCI bus)
640 K - 800 K	A0000 - C7FFF	160 KB	Video memory and BIOS
639 K - 640 K	9FC00 - 9FFFF	1 KB	Extended BIOS data (movable by memory manager software)
512 K - 639 K	80000 - 9FBFF	127 KB	Extended conventional memory
0 K - 512 K	00000 - 7FFFF	512 KB	Conventional memory

2.3 I/O Map

Table 13. I/O Map

Address (hex)	Size	Description
0000 - 000F	16 bytes	DMA controller
0020 - 0021	2 bytes	Programmable Interrupt Control (PIC)
0040 - 0043	4 bytes	System timer
0060	1 byte	Keyboard controller byte—reset IRQ
0061	1 byte	System speaker
0064	1 byte	Keyboard controller, CMD/STAT byte
0070 - 0071	2 bytes	System CMOS/Real Time Clock
0072 - 0073	2 bytes	System CMOS
0080 - 008F	16 bytes	DMA controller
0092	1 byte	Fast A20 and PIC
00A0 - 00A1	2 bytes	PIC
00B2 - 00B3	2 bytes	APM control
00C0 - 00DF	32 bytes	DMA
00F0	1 byte	Numeric data processor
0170 - 0177	8 bytes	Secondary IDE channel
01F0 - 01F7	8 bytes	Primary IDE channel
0228 - 022F (Note 1)	8 bytes	LPT3
0278 - 027F (Note 1)	8 bytes	LPT2
02E8 - 02EF (Note 1)	8 bytes	COM4/video (8514A)
02F8 - 02FF (Note 1)	8 bytes	COM2
0376	1 byte	Secondary IDE channel command port
0377, bits 6:0	7 bits	Secondary IDE channel status port
0378 - 037F	8 bytes	LPT1
03B0 - 03BB	12 bytes	Intel 82845 MCH
03C0 - 03DF	32 bytes	Intel 82845 MCH
03E8 - 03EF	8 bytes	COM3
03F0 - 03F5	6 bytes	Diskette channel 1
03F6	1 byte	Primary IDE channel command port
03F8 - 03FF	8 bytes	COM1
04D0 - 04D1	2 bytes	Edge/level triggered PIC
LPTn + 400	8 bytes	ECP port, LPTn base address + 400h
0CF8 - 0CFB (Note 2)	4 bytes	PCI configuration address register
0CF9 (Note 3)	1 byte	Turbo and reset control register
0CFC - 0CFF	4 bytes	PCI configuration data register
FFA0 - FFA7	8 bytes	Primary bus master IDE registers
FFA8 - FFAF	8 bytes	Secondary bus master IDE registers

continued

Table 13. I/O Map (continued)

Address (hex)	Description
8 bytes on an 8-byte boundary ^(Note 4)	OHCI controller
96 contiguous bytes starting on a 128-byte divisible boundary	ICH2 (ACPI + TCO)
64 contiguous bytes starting on a 64-byte divisible boundary	D845BG/D845PT board resource
64 contiguous bytes starting on a 64-byte divisible boundary	Onboard audio controller
32 contiguous bytes starting on a 32-byte divisible boundary ^(Note 5)	ICH2 (USB controller 1)
16 contiguous bytes starting on a 16-byte divisible boundary	ICH2 (SMBus)
4096 contiguous bytes starting on a 4096-byte divisible boundary	Intel 82801BA PCI bridge
256 contiguous bytes starting on a 256-byte divisible boundary	ICH2 audio mixer
64 contiguous bytes starting on a 64-byte divisible boundary	ICH2 audio bus mixer
256 contiguous bytes starting on a 256-byte divisible boundary	ICH2 modem mixer
32 contiguous bytes starting on a 32-byte divisible boundary ^(Note 5)	ICH2 (USB controller 2)
96 contiguous bytes starting on a 128-byte divisible boundary	LPC47M142

Notes:

1. Default, but can be changed to another address range
2. Dword access only
3. Byte access only
4. USB 2.0 option only
5. USB 1.1 option only

**NOTE**

Some additional I/O addresses are not available due to ICH2 address aliasing.

For information about	Refer to
ICH2 addressing	Section 1.3 on page 18

2.4 DMA Channels

Table 14. DMA Channels

DMA Channel Number	Data Width	System Resource
0	8 or 16 bits	Open
1	8 or 16 bits	Parallel port
2	8 or 16 bits	Diskette drive
3	8 or 16 bits	Parallel port (for ECP or EPP)
4	8 or 16 bits	DMA controller
5	16 bits	Open
6	16 bits	Open
7	16 bits	Open

2.5 PCI Configuration Space Map

Table 15. PCI Configuration Space Map

Bus Number (hex)	Device Number (hex)	Function Number (hex)	Description
00	00	00	Memory controller of Intel 82845 component
00	01	00	PCI to AGP bridge
00	1E	00	Hub link to PCI bridge
00	1F	00	Intel 82801BA ICH2 PCI to LPC bridge
00	1F	01	IDE controller
00	1F	02	USB
00	1F	03	SMBus controller
00	1F	04	USB
00	1F	05	AC '97 audio controller
00	1F	06	AC '97 modem controller (optional)
01	00	00	Add-in AGP adapter card
02	00	01	OHCI controller 1 ^(Note 1)
02	00	02	OHCI controller 2 ^(Note 1)
02	00	03	EHCI controller ^(Note 1)
02	08	00	LAN controller (optional)
02	09	00	PCI bus connector 1
02	0A	00	PCI bus connector 2
02	0B	00	PCI bus connector 3
02	0C	00	PCI bus connector 4 ^(Note 2)
02	0D	00	PCI bus connector 5 ^(Note 2)
02	0E	00	PCI bus connector 6 ^(Note 2)

Notes:

1. USB 2.0 option only
2. D845BG board only

2.6 Interrupts

The interrupts can be routed through either the Programmable Interrupt Controller (PIC) or the Advanced Programmable Interrupt Controller (APIC) portion of the ICH2 component. The PIC is supported in Windows 98 SE and Windows ME and uses the first 16 interrupts. The APIC is supported in Windows 2000 and Windows XP and supports a total of 24 interrupts.

Table 16. Interrupts

IRQ	System Resource
NMI	I/O channel check
0	Reserved, interval timer
1	Reserved, keyboard buffer full
2	Reserved, cascade interrupt from slave PIC
3	COM2 (Note 1)
4	COM1 (Note 1)
5	LPT2 (Plug and Play option)/User available
6	Diskette drive
7	LPT1 (Note 1)
8	Real-time clock
9	Reserved for ICH2 system management bus
10	User available
11	User available
12	Onboard mouse port (if present, else user available)
13	Reserved, math coprocessor
14	Primary IDE (if present, else user available)
15	Secondary IDE (if present, else user available)
16 (Note 2)	(through PIRQA) AGP video
17 (Note 2)	(through PIRQB) AC '97 audio/User available
18 (Note 2)	(through PIRQC) OHCI controller 1 (optional)
19 (Note 2)	(through PIRQD) ICH2 USB controller 1
20 (Note 2)	(through PIRQE) ICH2 LAN (optional)
21 (Note 2)	(through PIRQF) OHCI controller 2 (optional)/User available
22 (Note 2)	(through PIRQG) EHCI controller 1 (optional)/User available
23 (Note 2)	(through PIRQH) ICH2 USB controller 2/User available

Notes:

1. Default, but can be changed to another IRQ.
2. Available in APIC mode only.

2.7 PCI Interrupt Routing Map

This section describes interrupt sharing and how the interrupt signals are connected between the PCI bus connectors and onboard PCI devices. The PCI specification specifies how interrupts can be shared between devices attached to the PCI bus. In most cases, the small amount of latency added by interrupt sharing does not affect the operation or throughput of the devices. In some special cases where maximum performance is needed from a device, a PCI device should not share an interrupt with other PCI devices. Use the following information to avoid sharing an interrupt with a PCI add-in card.

PCI devices are categorized as follows to specify their interrupt grouping:

- INTA: By default, all add-in cards that require only one interrupt are in this category. For almost all cards that require more than one interrupt, the first interrupt on the card is also classified as INTA.
- INTB: Generally, the second interrupt on add-in cards that require two or more interrupts is classified as INTB. (This is not an absolute requirement.)
- INTC and INTD: Generally, a third interrupt on add-in cards is classified as INTC and a fourth interrupt is classified as INTD.

The ICH2 has eight programmable interrupt request (PIRQ) input signals. All PCI interrupt sources either onboard or from a PCI add-in card connect to one of these PIRQ signals. Some PCI interrupt sources are electrically tied together on the D845BG and D845PT boards and therefore share the same interrupt. Table 17 shows an example of how the PIRQ signals are routed on the D845BG and D845PT boards.

For example, using Table 17 as a reference, assume an add-in card using INTB is plugged into PCI bus connector 3. In PCI bus connector 3, INTB is connected to PIRQB, which is already connected to the SMBus. The add-in card in PCI bus connector 3 now shares interrupts with these onboard interrupt sources.

Table 17. PCI Interrupt Routing Map

PCI Interrupt Source	ICH2 PIRQ Signal Name				
	PIRQF	PIRQG	PIRQH	PIRQB	Other
AGP connector				INTB	INTA to PIRQA
ICH2 USB controller 1					INTD to PIRQD
SMBus controller				INTB	
ICH2 USB controller 2			INTC		
ICH2 Audio/Modem				INTB	
ICH2 LAN					INTA to PIRQE
OHCI controller 1 (Note 1)					INTA to PIRQC
OHCI controller 2 (Note 1)	INTB				
EHCI controller (Note 1)		INTC			
PCI bus connector 1	INTA	INTB	INTC	INTD	
PCI bus connector 2	INTD	INTA	INTB	INTC	
PCI bus connector 3	INTC	INTD	INTA	INTB	
PCI bus connector 4 (Note 2)	INTB	INTC	INTD	INTA	
PCI bus connector 5 (Note 2)	INTA	INTB	INTC	INTD	
PCI bus connector 6 (Note 2)	INTB	INTC	INTD	INTA	

Notes:

1. USB 2.0 option only
2. D845BG board only

 **NOTE**

In PIC mode, the ICH2 can connect each PIRQ line internally to one of the IRQ signals (3, 4, 5, 6, 7, 9, 10, 11, 12, 14, and 15). Typically, a device that does not share a PIRQ line will have a unique interrupt. However, in certain interrupt-constrained situations, it is possible for two or more of the PIRQ lines to be connected to the same IRQ signal. Refer to Table 16 for the allocation of PIRQ lines to IRQ signals in APIC mode.

2.8 Connectors



CAUTION

Only the back panel, the front panel audio, and the front panel USB connectors of the D845BG and D845PT boards have overcurrent protection. The D845BG and D845PT boards' internal connectors are not overcurrent protected and should connect only to devices inside the computer's chassis, such as fans and internal peripherals. Do not use these connectors to power devices external to the computer's chassis. A fault in the load presented by the external devices could cause damage to the computer, the interconnecting cable, and the external devices themselves.

This section describes the board's connectors. The connectors can be divided into the following groups:

- Back panel I/O connectors (see page 55)
 - PS/2 keyboard and mouse
 - USB (four with the USB 1.1 option, two with USB 2.0)
 - Parallel port
 - Serial port A
 - LAN (optional)
 - Audio (line out, line in, and mic in)
- Internal I/O connectors (see page 58)
 - Audio (auxiliary line input and ATAPI CD-ROM)
 - Fans
 - Power
 - Add-in boards (PCI and AGP)
 - CNR (optional)
 - IDE
 - Diskette drive
 - SCSI LED
- External I/O connectors (see page 71)
 - Front panel audio
 - Front panel USB
 - Serial port B
 - Auxiliary front panel power/sleep/message-waiting LED
 - Front panel (power/sleep/message-waiting LED, power switch, hard drive activity LED, reset switch, and auxiliary front panel power LED)



NOTE

When installing the board in a microATX chassis, make sure that peripheral devices are installed at least 1.5 inches above the main power connector, the diskette drive connector, the IDE connector, and the DIMM sockets.

2.8.1 Back Panel Connectors

Figure 11 shows the location of the back panel connectors. The back panel connectors are color-coded in compliance with PC 99 recommendations. The figure legend below lists the colors used.

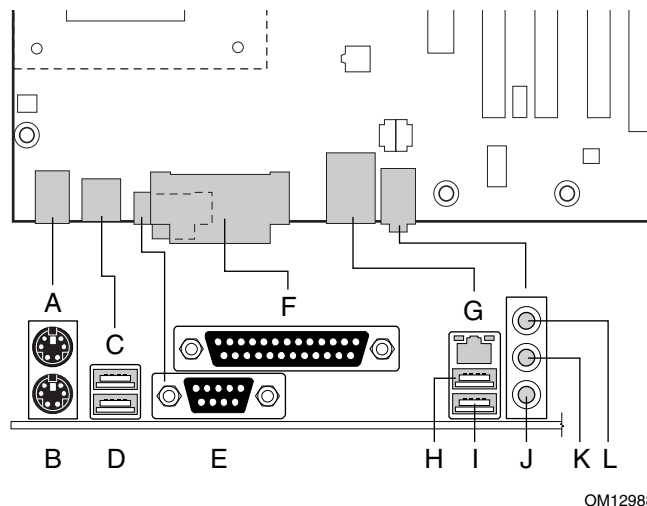

OM12988

Item	Description	Color	For more information see:
A	PS/2 mouse port	Green	Table 18
B	PS/2 keyboard port	Purple	Table 18
C	USB port (optional)	Black	Table 19
D	USB port (optional)	Black	Table 19
E	Serial port A	Teal	Table 21
F	Parallel port	Burgundy	Table 20
G	LAN (optional)	Black	Table 22
H	USB port	Black	Table 19
I	USB port	Black	Table 19
J	Mic in	Pink	Table 25
K	Audio line out	Lime green	Table 24
L	Audio line in	Light blue	Table 23

Figure 11. Back Panel Connectors

NOTE

The USB ports adjacent to the PS/2 ports are not populated if the USB 2.0 option is supported.

NOTE

The back panel audio line out connector is designed to power headphones or amplified speakers only. Poor audio quality occurs if passive (non-amplified) speakers are connected to this output.

Table 18. PS/2 Mouse/Keyboard Connector

Pin	Signal Name
1	Data
2	Not connected
3	Ground
4	+5 V (Fused)
5	Clock
6	Not connected

Table 19. USB Connectors

Pin	Signal Name
1	+5 V (Fused)
2	USB#
3	USB
4	Ground

Table 20. Parallel Port Connector

Pin	Standard Signal Name	ECP Signal Name	EPP Signal Name
1	STROBE#	STROBE#	WRITE#
2	PD0	PD0	PD0
3	PD1	PD1	PD1
4	PD2	PD2	PD2
5	PD3	PD3	PD3
6	PD4	PD4	PD4
7	PD5	PD5	PD5
8	PD6	PD6	PD6
9	PD7	PD7	PD7
10	ACK#	ACK#	INTR
11	BUSY	BUSY#, PERIPHACK	WAIT#
12	PERROR	PE, ACKREVERSE#	PE
13	SELECT	SELECT	SELECT
14	AUDOFD#	AUDOFD#, HOSTACK	DATASTB#
15	FAULT#	FAULT#, PERIPHREQST#	FAULT#
16	INIT#	INIT#, REVERSERQST#	RESET#
17	SLCTIN#	SLCTIN#	ADDRSTB#
18 – 25	Ground	Ground	Ground

Table 21. Serial Port A Connector

Pin	Signal Name
1	DCD (Data Carrier Detect)
2	RXD# (Receive Data)
3	TXD# (Transmit Data)
4	DTR (Data Terminal Ready)
5	Ground
6	DSR (Data Set Ready)
7	RTS (Request to Send)
8	CTS (Clear to Send)
9	RI (Ring Indicator)

Table 22. LAN Connector (Optional)

Pin	Signal Name
1	TX+
2	TX-
3	RX+
4	Ground
5	Ground
6	RX-
7	Ground
8	Ground

Table 23. Audio Line In Connector

Pin	Signal Name
Tip	Audio left in
Ring	Audio right in
Sleeve	Ground

Table 24. Audio Line Out Connector

Pin	Signal Name
Tip	Audio left out
Ring	Audio right out
Sleeve	Ground

Table 25. Mic In Connector

Pin	Signal Name
Tip	Mono in
Ring	Mic bias voltage
Sleeve	Ground

2.8.2 Internal I/O Connectors

The internal I/O connectors are divided into the following functional groups:

- Audio (see page 59)
 - Auxiliary line in
 - ATAPI CD-ROM
- Power and hardware control (see page 61)
 - Fans (three)
 - ATX12V
 - Main power
- Add-in boards and peripheral interfaces (see page 64)
 - CNR (communication and networking riser)
 - PCI bus (six on the D845BG board; three on the D845PT board)
 - AGP
 - IDE (two)
 - Diskette drive
 - SCSI LED

2.8.2.1 Expansion Slots

The board has the following expansion slots:

- One AGP connector. The AGP connector is keyed for 1.5 V AGP cards only. Do not install a legacy 3.3 V AGP card. The AGP connector is not mechanically compatible with legacy 3.3 V AGP cards.
- PCI rev 2.2 compliant local bus slots (six on the D845BG board, three on the D845PT board). The SMBus is routed to PCI bus connector 1 only (ATX expansion slot 6). PCI add-in cards with SMBus support can access sensor data and other information residing on the board.
- One CNR (optional), shared with PCI bus connector 3 (ATX expansion slot 1) on the D845PT board or with PCI bus connector 6 (ATX expansion slot 1) on the D845BG board.

NOTE

This document references back-panel slot numbering with respect to processor location on the board. The AGP slot is not numbered. PCI slots are identified as PCI slot #x, starting with the slot closest to the processor. The CNR slot shares an ATX expansion; slot 6 on the D845BG board and slot 3 on the D845PT. The ATX/MicroATX specifications identify expansion slot locations with respect to the far edge of a full-sized ATX chassis. The ATX specification and the board's silkscreen are opposite and could cause confusion. The ATX numbering convention is made without respect to slot type (PCI vs. AGP), but refers to an actual slot location on a chassis. Figure 14 on page 64 illustrates the board's PCI slot numbering.

2.8.2.2 Audio Connectors

Figure 12 shows the location of the audio connectors.

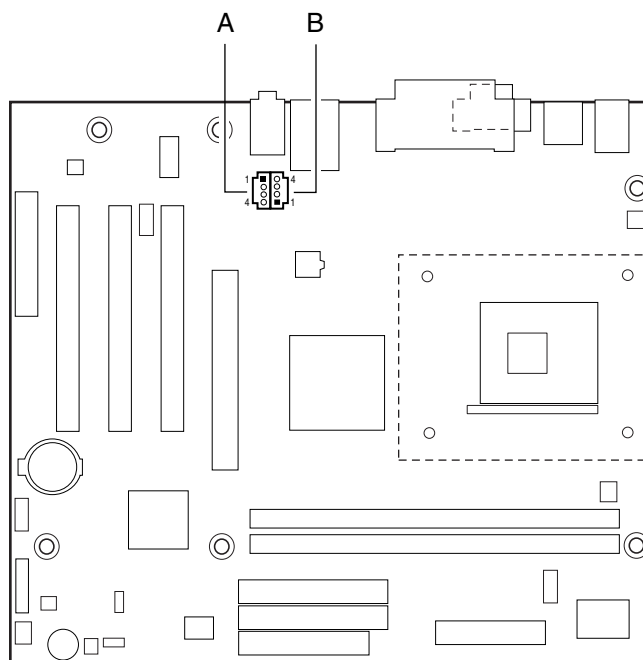

OM12989

Item	Description	Color	For more information see:
A	Auxiliary line in, ATAPI style	White	Table 26
B	ATAPI CD-ROM	Black	Table 27

Figure 12. Audio Connectors

 **NOTE**

The front panel audio connector is described in Section 2.8.3, beginning on page 71.

Table 26. Auxiliary Line In Connector

Pin	Signal Name
1	Left auxiliary line in
2	Ground
3	Ground
4	Right auxiliary line in

Table 27. ATAPI CD-ROM Connector

Pin	Signal Name
1	Left audio input from CD-ROM
2	CD audio differential ground
3	CD audio differential ground
4	Right audio input from CD-ROM

2.8.2.3 Power and Hardware Control Connectors

Figure 13 shows the location of the power and hardware control connectors.

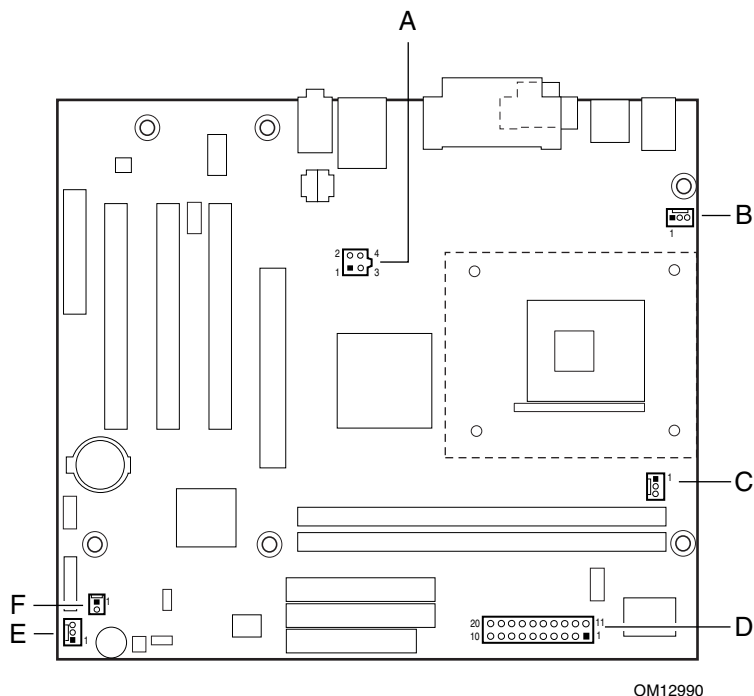

OM12990

Item	Description	For more information see:
A	+12 V power connector (ATX12V)	Table 28
B	Rear chassis fan	Table 29
C	Processor fan	Table 30
D	Main power	Table 31
E	Front chassis fan	Table 32
F	Chassis intrusion	Table 33

Figure 13. Power and Hardware Control Connectors

For information about	Refer to
The power connector	Section 1.14.2.1, page 42
The functions of the fan connectors	Section 1.14.2.2, page 43

NOTE

Use only ATX12V- or SFX12V-compliant power supplies with the D845BG and D845PT boards. ATX12V and SFX12V power supplies have an additional power lead that provides required supplemental power for the Intel Pentium 4 processor. Always connect the 20-pin and 4-pin leads of ATX12V and SFX12V power supplies to the corresponding connectors on the D845BG and D845PT boards, otherwise the board will not boot.

Do not use a standard ATX power supply. The board will not boot with a standard ATX power supply.

Table 28. ATX12V Power Connector

Pin	Signal Name	Pin	Signal Name
1	Ground	2	Ground
3	+12 V	4	+12 V

 **NOTE**

The board will not boot if the ATX12V power connector is not attached to the board.

Table 29. Rear Chassis Fan Connector

Pin	Signal Name
1	Ground
2	VREG_12V_POWER
3	REAR_FAN_TACH

Table 30. Processor Fan Connector

Pin	Signal Name
1	Ground
2	VREG_12V_POWER
3	CPU_FAN_TACH

Table 31. Main Power Connector

Pin	Signal Name	Pin	Signal Name
1	+3.3 V	11	+3.3 V
2	+3.3 V	12	-12 V
3	Ground	13	Ground
4	+5 V	14	PS-ON# (power supply remote on/off)
5	Ground	15	Ground
6	+5 V	16	Ground
7	Ground	17	Ground
8	PWRGD (Power Good)	18	No connect
9	+5 V (Standby)	19	+5 V
10	+12 V	20	+5 V

Table 32. Front Chassis Fan Connector

Pin	Signal Name
1	Ground
2	+12 V
3	No connect

Table 33. Chassis Intrusion Connector

Pin	Signal Name
1	Intruder
2	Ground

2.8.2.4 Add-in Board and Peripheral Interface Connectors

Figure 14 shows the location of the add-in board connector and peripheral connectors for the D845BG board. Note the following considerations for the PCI bus connectors (for both boards):

- All of the PCI bus connectors are bus master capable.
- PCI bus connector 1 has SMBus signals routed to it. This enables PCI bus add-in boards with SMBus support to access sensor data on the board. The specific SMBus signals are as follows:
 - The SMBus clock line is connected to pin A40
 - The SMBus data line is connected to pin A41

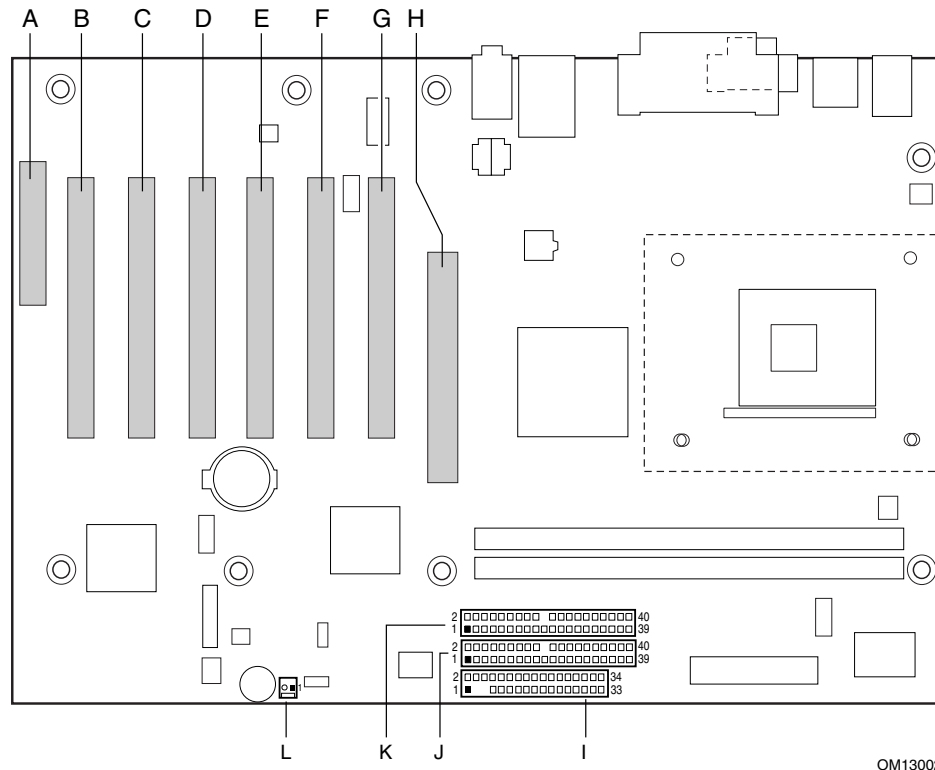

OM13002

Item	Description	For more information see:
A	Communication and Networking Riser (CNR)	Table 34
B	PCI bus connector 6	Table 35
C	PCI bus connector 5	Table 35
D	PCI bus connector 4	Table 35
E	PCI bus connector 3	Table 35
F	PCI bus connector 2	Table 35
G	PCI bus connector 1	Table 35
H	AGP connector	Table 36
I	Diskette drive	Table 37
J	Primary IDE	Table 38
K	Secondary IDE	Table 38
L	SCSI LED	Table 39

Figure 14. D845BG Add-in Board and Peripheral Interface Connectors

Figure 15 shows the location of the add-in board connector and peripheral connectors for the D845PT board.

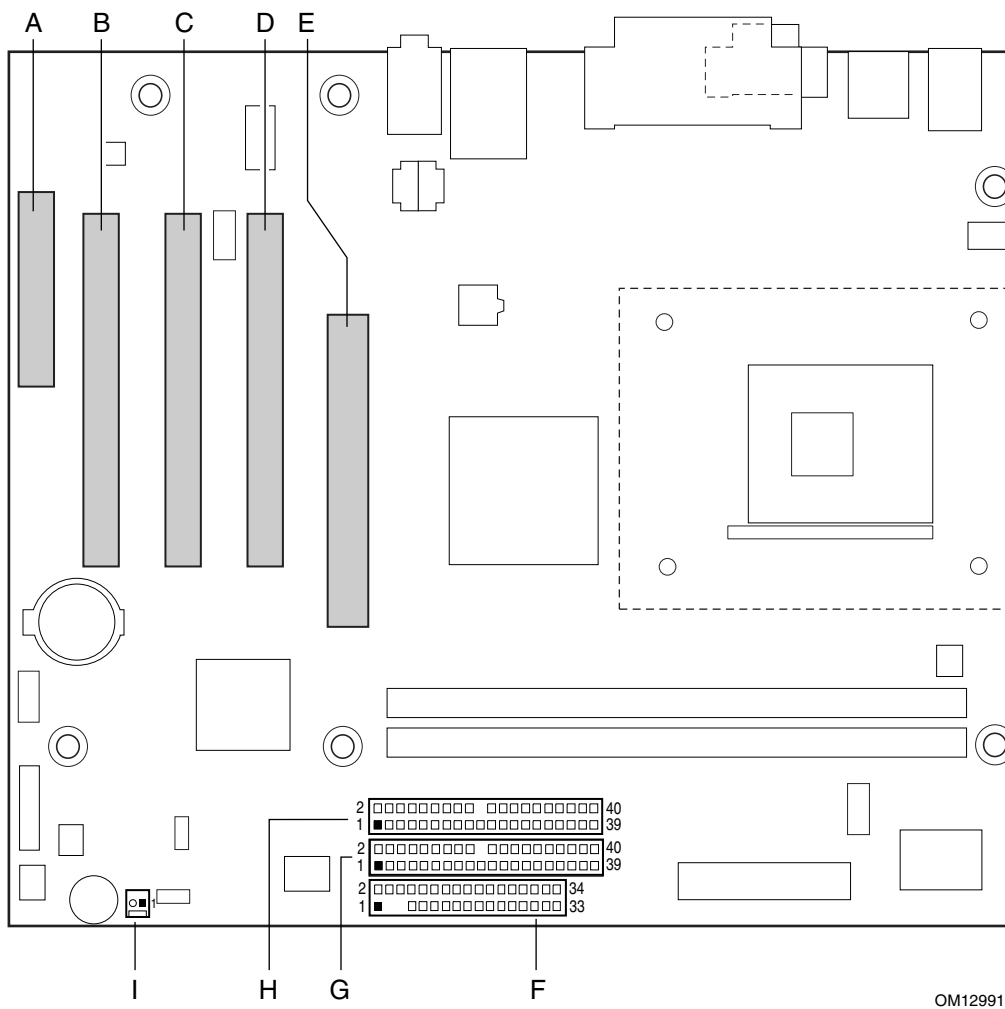

Item	Description	For more information see:
A	Communication and Networking Riser (CNR)	Table 34
B	PCI bus connector 3	Table 35
C	PCI bus connector 2	Table 35
D	PCI bus connector 1	Table 35
E	AGP connector	Table 36
F	Diskette drive	Table 37
G	Primary IDE	Table 38
H	Secondary IDE	Table 38
I	SCSI LED	Table 39

Figure 15. D845PT Add-in Board and Peripheral Interface Connectors

Table 34. CNR Connector (Optional)

Pin	Signal Name	Pin	Signal Name
A1	Reserved	B1	Reserved
A2	Reserved	B2	Reserved
A3	Ground	B3	Reserved
A4	Reserved	B4	Ground
A5	Reserved	B5	Reserved
A6	Ground	B6	Reserved
A7	LAN_TXD2	B7	Ground
A8	LAN_TXD0	B8	LAN_TXD1
A9	Ground	B9	LAN_RSTSYNC
A10	LAN_CLK	B10	Ground
A11	LAN_RXD1	B11	LAN_RXD2
A12	Reserved	B12	LAN_RXD0
A13	USB+	B13	Ground
A14	Ground	B14	Reserved
A15	USB-	B15	+5 V (dual)
A16	+12 V	B16	USB_OC
A17	Ground	B17	Ground
A18	+3.3 V (dual)	B18	-12 V
A19	+5 V	B19	+3.3 V
A20	Ground	B20	Ground
A21	EEDI	B21	EED0
A22	EECS	B22	EECK
A23	SMB_A1	B23	Ground
A24	SMB_A2	B24	SMB_A0
A25	SMB_SDA	B25	SMB_SCL
A26	AC97_RESET	B26	CDC_DWN_ENAB
A27	Reserved	B27	Ground
A28	AC97_SDATA_IN1	B28	AC97_SYNC
A29	AC97_SDATA_IN0	B29	AC97_SDATA_OUT
A30	Ground	B30	AC97_BITCLK

For information about

The CNR

Refer to

Section 1.12, page 36

Table 35. PCI Bus Connectors

Pin	Signal Name	Pin	Signal Name	Pin	Signal Name	Pin	Signal Name
A1	Ground (TRST#)*	B1	-12 V	A32	AD16	B32	AD17
A2	+12 V	B2	Ground (TCK)*	A33	+3.3 V	B33	C/BE2#
A3	+5 V (TMS)*	B3	Ground	A34	FRAME#	B34	Ground
A4	+5 V (TDI)*	B4	Not connected (TDO)*	A35	Ground	B35	IRDY#
A5	+5 V	B5	+5 V	A36	TRDY#	B36	+3.3 V
A6	INTA#	B6	+5 V	A37	Ground	B37	DEVSEL#
A7	INTC#	B7	INTB#	A38	STOP#	B38	Ground
A8	+5 V	B8	INTD#	A39	+3.3 V	B39	LOCK#
A9	Reserved	B9	Not connected (PRSENT1#)*	A40	Reserved **	B40	PERR#
A10	+5 V (I/O)	B10	Reserved	A41	Reserved ***	B41	+3.3 V
A11	Reserved	B11	Not connected (PRSENT2#)*	A42	Ground	B42	SERR#
A12	Ground	B12	Ground	A43	PAR	B43	+3.3 V
A13	Ground	B13	Ground	A44	AD15	B44	C/BE1#
A14	+3.3 V aux	B14	Reserved	A45	+3.3 V	B45	AD14
A15	RST#	B15	Ground	A46	AD13	B46	Ground
A16	+5 V (I/O)	B16	CLK	A47	AD11	B47	AD12
A17	GNT#	B17	Ground	A48	Ground	B48	AD10
A18	Ground	B18	REQ#	A49	AD09	B49	Ground
A19	PME#	B19	+5 V (I/O)	A50	Key	B50	Key
A20	AD30	B20	AD31	A51	Key	B51	Key
A21	+3.3 V	B21	AD29	A52	C/BE0#	B52	AD08
A22	AD28	B22	Ground	A53	+3.3 V	B53	AD07
A23	AD26	B23	AD27	A54	AD06	B54	+3.3 V
A24	Ground	B24	AD25	A55	AD04	B55	AD05
A25	AD24	B25	+3.3 V	A56	Ground	B56	AD03
A26	IDSEL	B26	C/BE3#	A57	AD02	B57	Ground
A27	+3.3 V	B27	AD23	A58	AD00	B58	AD01
A28	AD22	B28	Ground	A59	+5 V (I/O)	B59	+5 V (I/O)
A29	AD20	B29	AD21	A60	REQ64#	B60	ACK64#
A30	Ground	B30	AD19	A61	+5 V	B61	+5 V
A31	AD18	B31	+3.3 V	A62	+5 V	B62	+5 V

* These signals (in parentheses) are optional in the PCI specification and are not currently implemented.

** On PCI bus connector 1, this pin is connected to the SMBus clock line.

*** On PCI bus connector 1, this pin is connected to the SMBus data line.

Table 36. AGP Connector

Pin	Signal Name	Pin	Signal Name	Pin	Signal Name	Pin	Signal Name
A1	+12 V	B1	Not connected	A34	Vddq	B34	Vddq
A2	TYPEDET#	B2	+5 V	A35	AD22	B35	AD21
A3	Reserved	B3	+5 V	A36	AD20	B36	AD19
A4	Not connected	B4	Not connected	A37	Ground	B37	Ground
A5	Ground	B5	Ground	A38	AD18	B38	AD17
A6	INTA#	B6	INTB#	A39	AD16	B39	C/BE2#
A7	RST#	B7	CLK	A40	Vddq	B40	Vddq
A8	GNT1#	B8	REQ#	A41	FRAME#	B41	IRDY#
A9	Vcc3.3	B9	Vcc3.3	A42	Reserved	B42	+3.3 V (aux)
A10	ST1	B10	ST0	A43	Ground	B43	Ground
A11	Reserved	B11	ST2	A44	Reserved	B44	Reserved
A12	PIPE#	B12	RBF#	A45	Vcc3.3	B45	Vcc3.3
A13	Ground	B13	Ground	A46	TRDY#	B46	DEVSEL#
A14	WBF#	B14	Reserved	A47	STOP#	B47	Vddq
A15	SBA1	B15	SBA0	A48	PME#	B48	PERR#
A16	Vcc3.3	B16	Vcc3.3	A49	Ground	B49	Ground
A17	SBA3	B17	SBA2	A50	PAR	B50	SERR#
A18	SBSTB#	B18	SB_STB	A51	AD15	B51	C/BE1#
A19	Ground	B19	Ground	A52	Vddq	B52	Vddq
A20	SBA5	B20	SBA4	A53	AD13	B53	AD14
A21	SBA7	B21	SBA6	A54	AD11	B54	AD12
A22	Reserved	B22	Reserved	A55	Ground	B55	Ground
A23	Ground	B23	Ground	A56	AD9	B56	AD10
A24	Reserved	B24	+3.3 V (aux)	A57	C/BE0#	B57	AD8
A25	Vcc3.3	B25	Vcc3.3	A58	Vddq	B58	Vddq
A26	AD30	B26	AD31	A59	AD_STB0#	B59	AD_STB0
A27	AD28	B27	AD29	A60	AD6	B60	AD7
A28	Vcc3.3	B28	Vcc3.3	A61	Ground	B61	Ground
A29	AD26	B29	AD27	A62	AD4	B62	AD5
A30	AD24	B30	AD25	A63	AD2	B63	AD3
A31	Ground	B31	Ground	A64	Vddq	B64	Vddq
A32	AD_STB1#	B32	AD_STB1	A65	AD0	B65	AD1
A33	C/BE3#	B33	AD23	A66	VRREFG_C	B66	VREFC_G

**NOTE**

The AGP connector is keyed for 1.5 V AGP cards only. Do not attempt to install a legacy 3.3 V AGP card. The AGP connector is not mechanically compatible with legacy 3.3 V AGP cards.

Table 37. Diskette Drive Connector

Pin	Signal Name	Pin	Signal Name
1	Ground	2	DENSEL
3	Key	4	Not connected
5	Key	6	DRVDEN1
7	Ground	8	FDINDEX#
9	Ground	10	MTR0# (Motor Enable A)
11	Ground	12	Not connected
13	Ground	14	DS0# (Drive Select A)
15	Ground	16	Not connected
17	Not connected	18	DIR# (Stepper Motor Direction)
19	Ground	20	STEP# (Step Pulse)
21	Ground	22	WDATA# (Write Data)
23	Ground	24	WGATE# (Write Enable)
25	Ground	26	TRK0# (Track 0)
27	Not connected	28	WRTPRT# (Write Protect)
29	Ground	30	RDATA# (Read Data)
31	Ground	32	HDSEL# (Side 1 Select)
33	Ground	34	DSKCHG# (Diskette Change)

Table 38. PCI IDE Connectors

Pin	Signal Name	Pin	Signal Name
1	Reset IDE	2	Ground
3	Data 7	4	Data 8
5	Data 6	6	Data 9
7	Data 5	8	Data 10
9	Data 4	10	Data 11
11	Data 3	12	Data 12
13	Data 2	14	Data 13
15	Data 1	16	Data 14
17	Data 0	18	Data 15
19	Ground	20	Key
21	DDRQ0 [DDRQ1]	22	Ground
23	I/O Write#	24	Ground
25	I/O Read#	26	Ground
27	IOCHRDY	28	Ground
29	DDACK0# [DDACK1#]	30	Ground
31	IRQ 14 [IRQ 15]	32	Not connected
33	DAG1 (Address 1)	34	GPIO_DMA66_Detect_Pri (GPIO_DMA66_Detect_Sec)
35	DAG0 (Address 0)	36	DAG2 (Address 2)
37	Chip Select 1P# [Chip Select 1S#]	38	Chip Select 3P# [Chip Select 3S#]
39	Activity#	40	Ground

Signal names in brackets ([]) are for the secondary IDE connector.

Table 39. SCSI LED Connector

Pin	Signal Name
1	SCSI_ACT#
2	No connect

2.8.3 External I/O Connectors

Figure 16 shows the locations of the external I/O connectors.

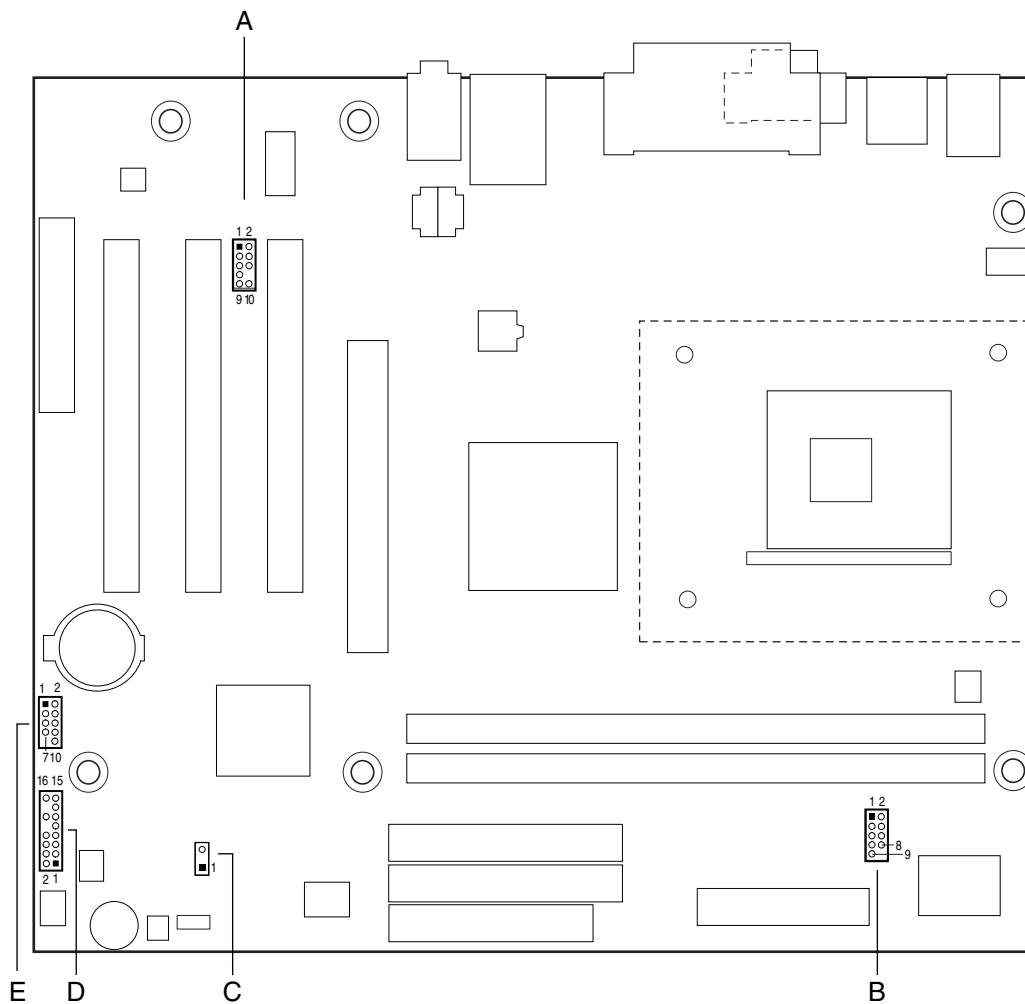

OM12992

Item	Description	For more information see:
A	Front panel audio	Table 40
B	Serial port B	Table 41
C	Auxiliary front panel power/sleep/message-waiting LED	Table 43
D	Front panel	Table 44
E	Front panel USB	Table 42

Figure 16. External I/O Connectors

Table 40. Front Panel Audio Connector

Pin	Signal Name	Pin	Signal Name
1	MIC_IN_FP	2	Ground
3	MIC_BIAS	4	V_5P0_AUD_ANALOG
5	R_FNTOUT	6	R_RETIN
7	Ground	8	Key
9	L_FNT_OUT	10	L_RETIN

 **NOTE**

The front panel audio connector is alternately used as a jumper block for routing audio signals. Refer to Section 2.9.1 on page 75 for more information.

Table 41. Serial Port B Connector

Pin	Signal Name	Pin	Signal Name
1	DCD (Data Carrier Detect)	2	DSR (Data Set Ready)
3	RXD# (Receive Data)	4	RTS (Request to Send)
5	TXD# (Transmit Data)	6	CTS (Clear to Send)
7	DTR (Data Terminal Ready)	8	RI (Ring Indicator)
9	Ground	10	Not connected

Table 42. Front Panel USB Connector

Pin	Signal Name	Pin	Signal Name
1	USB_FNT_PWR	2	USB_FNT_PWR
3	USB_FNT1#	4	USB_FNT2#
5	USB_FNT1	6	USB_FNT2
7	Ground	8	Ground
9	Not connected	10	Not connected

2.8.3.1 Auxiliary Front Panel Power/Sleep/Message-Waiting LED Connector

Pins 1 and 3 of this connector duplicate the signals on pins 2 and 4 of the front panel connector.

Table 43. Auxiliary Front Panel Power/Sleep/Message-Waiting LED Connector

Pin	Signal Name	In/Out	Description
1	HDR_BLNK_GRN	Out	Front panel green LED
2	Not connected		
3	HDR_BLNK_YEL	Out	Front panel yellow LED

2.8.3.2 Front Panel Connector

This section describes the functions of the front panel connector. Table 44 lists the signal names of the front panel connector.

Table 44. Front Panel Connector

Pin	Signal	In/Out	Description	Pin	Signal	In/Out	Description
Hard Drive Activity LED				Power LED			
1	HD_PWR	Out	Hard disk LED pull-up (330 Ω) to +5 V	2	HDR_BLNK_GRN	Out	Front panel green LED
3	HAD#	Out	Hard disk active LED	4	HDR_BLNK_YEL	Out	Front panel yellow LED
Reset Switch				On/Off Switch			
5	Ground		Ground	6	FPBUT_IN	In	Power switch
7	FP_RESET#	In	Reset switch	8	Ground		Ground
No Connect				Miscellaneous			
9	+5 V	Out	Power	10	N/C		Not connected
11	N/C		No connect	12	Ground		Ground
13	Ground		Ground	14	(pin removed)		Not connected
15	N/C		No connect	16	+5 V	Out	Power

2.8.3.2.1 Hard Drive Activity LED Connector

Pins 1 and 3 can be connected to an LED to provide a visual indicator that data is being read from or written to a hard drive. For the LED to function properly, an IDE drive must be connected to the onboard IDE interface. The LED will also show activity for devices connected to the SCSI hard drive activity LED connector.

For information about

The SCSI hard drive activity LED connector

Refer to

Section 1.8.3.2, page 29

2.8.3.2.2 Reset Switch Connector

Pins 5 and 7 can be connected to a momentary SPST type switch that is normally open. When the switch is closed, the D845BG/D845PT board resets and runs the POST.

2.8.3.2.3 Power/Sleep/Message Waiting LED Connector

Pins 2 and 4 can be connected to a one- or two-color LED. Table 45 shows the possible states for a one-color LED. Table 46 shows the possible states for a two-color LED.

Table 45. States for a One-Color Power LED

LED State	Description
Off	Power off/sleeping
Steady Green	Running
Blinking Green	Running/message waiting

Table 46. States for a Two-Color Power LED

LED State	Description
Off	Power off
Steady Green	Running
Blinking Green	Running/message waiting
Steady Yellow	Sleeping
Blinking Yellow	Sleeping/message waiting

**NOTE**

To use the message waiting function, ACPI must be enabled in the operating system and a message-capturing application must be invoked.

2.8.3.2.4 Power Switch Connector

Pins 6 and 8 can be connected to a front panel momentary-contact power switch. The switch must pull the SW_ON# pin to ground for at least 50 ms to signal the power supply to switch on or off. (The time requirement is due to internal debounce circuitry on the D845BG/D845PT board.) At least two seconds must pass before the power supply will recognize another on/off signal.

2.9 Jumper Blocks



CAUTION

Do not move any jumpers with the power on. Always turn off the power and unplug the power cord from the computer before changing a jumper setting. Otherwise, the board could be damaged.

Figure 17 shows the location of the jumper blocks on the D845BG and D845PT boards.

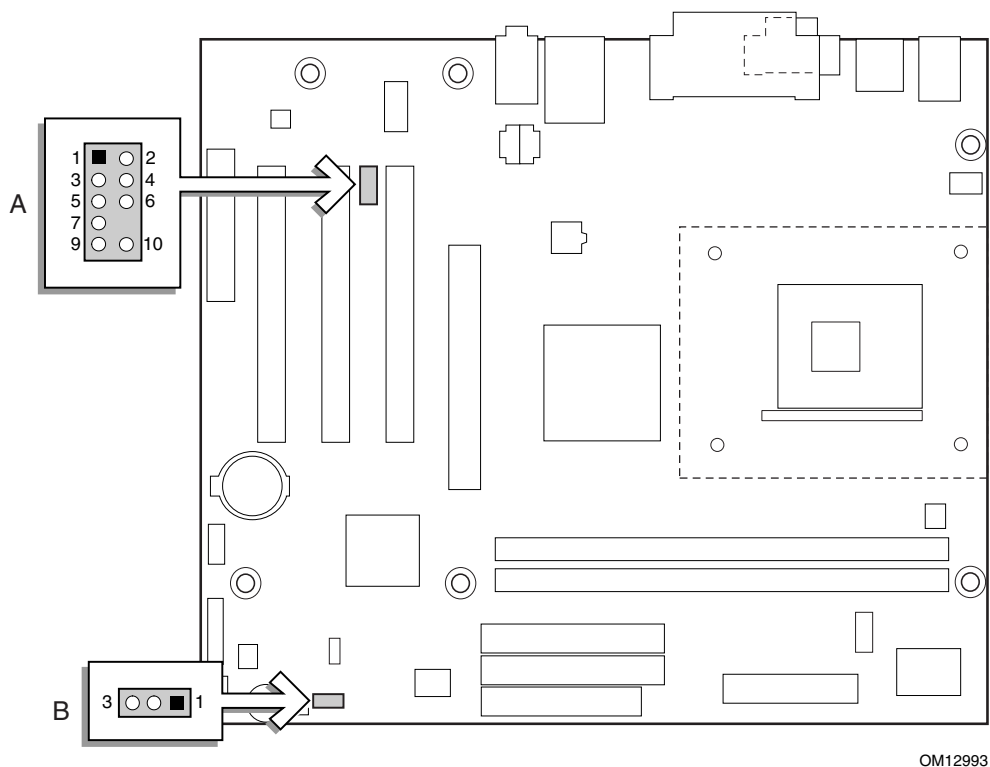

Item	Description	Reference Designator
A	Front panel audio connector/jumper block	J6B1
B	BIOS Setup configuration jumper block	J6H2

Figure 17. Location of the Jumper Blocks

2.9.1 Front Panel Audio Connector/Jumper Block

This connector has two functions:

- With jumpers installed, the audio line out signals are routed to the back panel audio line out connector.
- With jumpers removed, the connector provides audio line out and mic in signals for front panel audio connectors.

Table 47 describes the two configurations of this connector/jumper block.



CAUTION

Do not place jumpers on this block in any configuration other than the one described in Table 47. Other jumper configurations are not supported and could damage the board.

Table 47. Front Panel Audio Connector/Jumper Block

Jumper Setting	Configuration
<p>5 and 6 9 and 10</p>	Audio line out signals are routed to the back panel audio line out connector. The back panel audio line out connector is shown in Figure 11 on page 55.
<p>No jumpers installed</p>	Audio line out and mic in signals are available for front panel audio connectors. Table 40 on page 72 lists the names of the signals available on this connector when no jumpers are installed.



NOTE

When the jumpers are removed and this connector is used for front panel audio, the back panel audio line out and mic in connectors are disabled.

2.9.2 BIOS Setup Configuration Jumper Block

The 3-pin jumper block determines the BIOS Setup program’s mode. Table 48 describes the jumper settings for the three modes: normal, configure, and recovery. When the jumper is set to configuration mode and the computer is powered-up, the BIOS compares the processor version and the microcode version in the BIOS and reports if the two match.

Table 48. BIOS Setup Configuration Jumper Settings

Function/Mode	Jumper Setting	Configuration
Normal	1-2 1	The BIOS uses current configuration information and passwords for booting.
Configure	2-3 1	After the POST runs, Setup runs automatically. The maintenance menu is displayed.
Recovery	None 1	The BIOS attempts to recover the BIOS configuration. A recovery diskette is required.

For information about

Refer to

How to access the BIOS Setup program	Section 4.1, page 99
The maintenance menu of the BIOS Setup program	Section 4.2, page 100
BIOS recovery	Section 3.7, page 95

2.10 Mechanical Considerations

2.10.1 D845BG Form Factor

The D845BG board is designed to fit into an ATX-form-factor chassis. Figure 18 illustrates the mechanical form factor for the D845BG board. Dimensions are given in inches [millimeters]. The outer dimensions are 12.00 inches by 8.20 inches [304.80 millimeters by 208.28 millimeters]. Location of the I/O connectors and mounting holes are in compliance with the ATX specification (see Section 1.5).

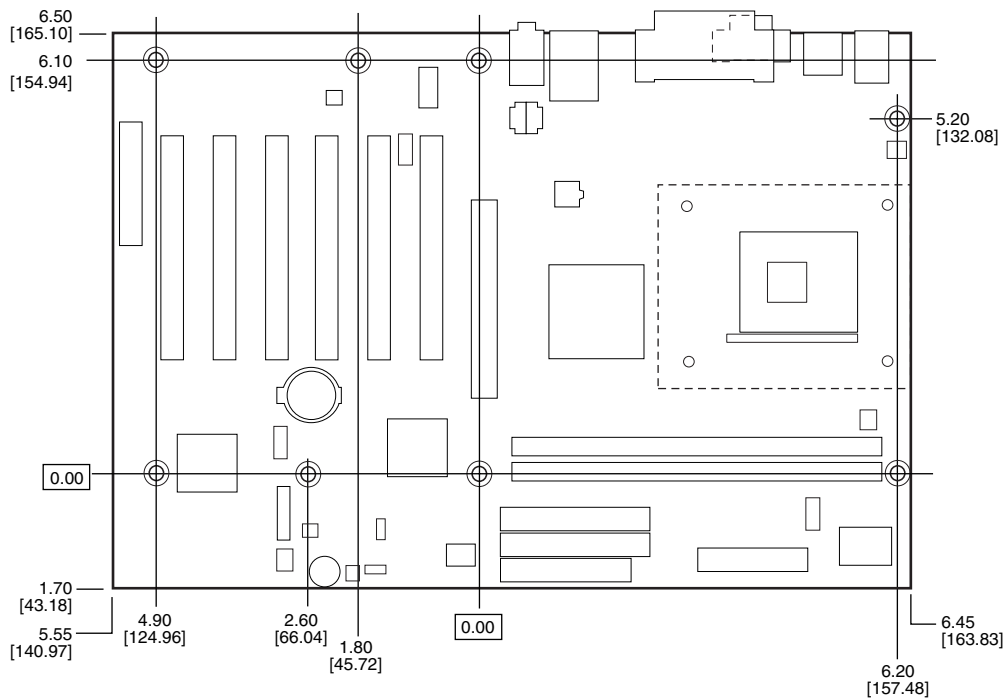

OM13005

Figure 18. D845BG Board Dimensions

2.10.2 D845PT Form Factor

The D845PT board is designed to fit into either a microATX or an ATX-form-factor chassis. Figure 19 illustrates the mechanical form factor for the D845PT board. Dimensions are given in inches [millimeters]. The outer dimensions are 9.60 inches by 8.20 inches [243.84 millimeters by 208.28 millimeters]. Location of the I/O connectors and mounting holes are in compliance with the ATX specification (see Section 1.5).

 **NOTE**

When installing the board in a microATX chassis, make sure that peripheral devices are installed at least 1.5 inches above the main power connector, the diskette drive connector, and the IDE connector, and the DIMM sockets.

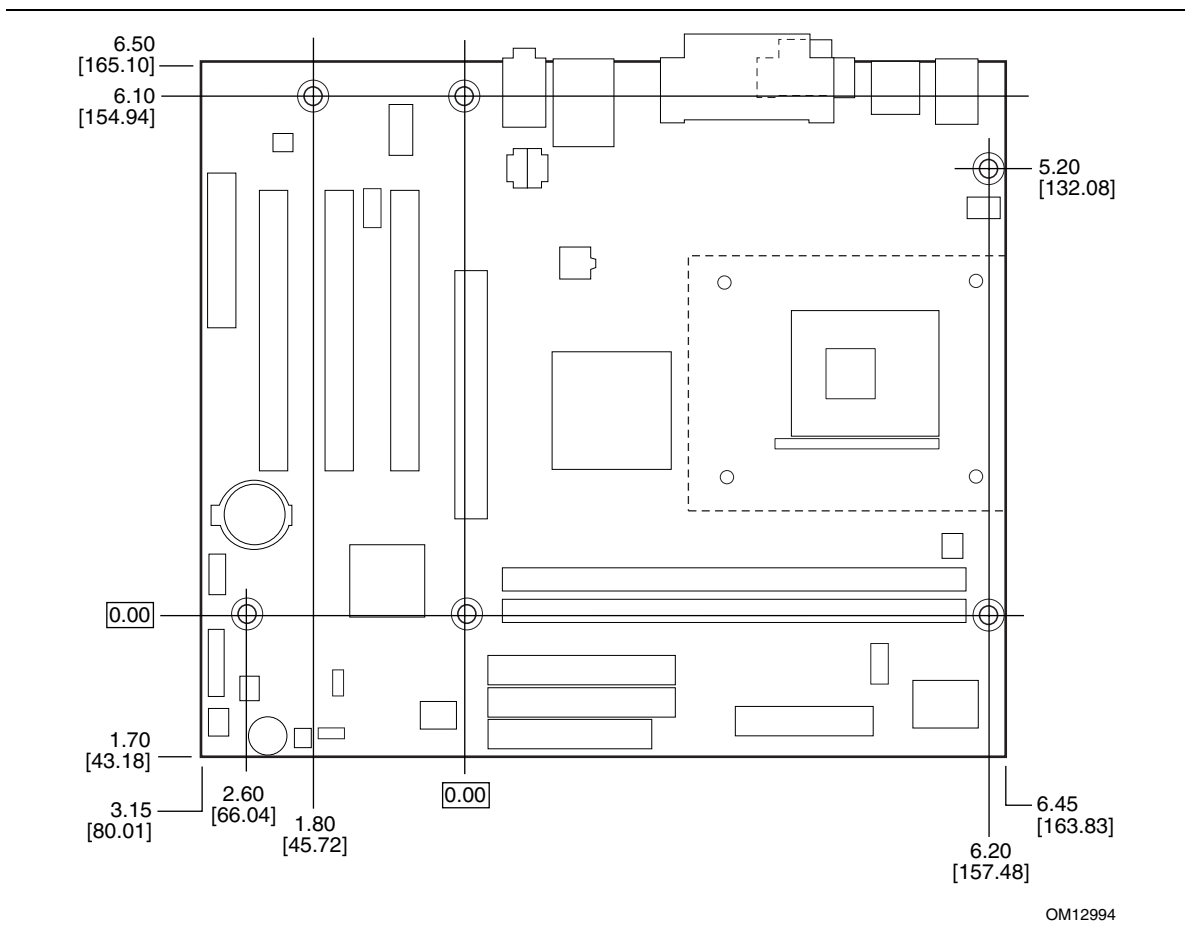

Figure 19. D845PT Board Dimensions

2.10.3 I/O Shield

The back panel I/O shield for D845BG and D845PT boards must meet specific dimension and material requirements. Systems based on this board need the back panel I/O shield to pass certification testing. Figures 20-22 show the critical dimensions of the three types of chassis-dependent I/O shields for the boards. Figure 20 shows the I/O shield for boards with the onboard LAN subsystem, but not the USB 2.0 option. Figure 21 shows the I/O shield for boards without the onboard LAN subsystem and the USB 2.0 option. Figure 22 shows the I/O shield for boards without the onboard LAN subsystem, but with the USB 2.0 option. Dimensions are given in inches to a tolerance of ± 0.02 inches.

The figures also indicate the position of each cutout. Additional design considerations for I/O shields relative to chassis requirements are described in the ATX specification. See Section 1.5 for information about the ATX specification.

NOTE

The I/O shield drawings in this document are for reference only. An I/O shield compliant with the ATX chassis specification 2.01 is available from Intel.

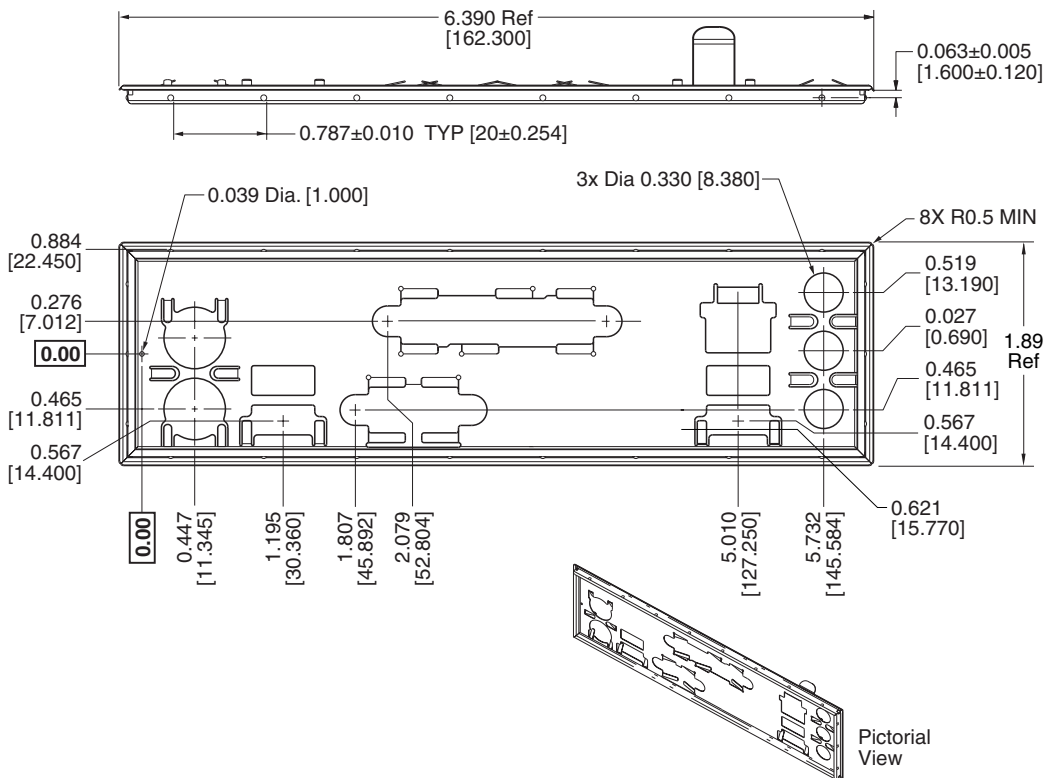

OM12352

Figure 20. I/O Shield Dimensions (for boards with the LAN Subsystem, but not USB 2.0)

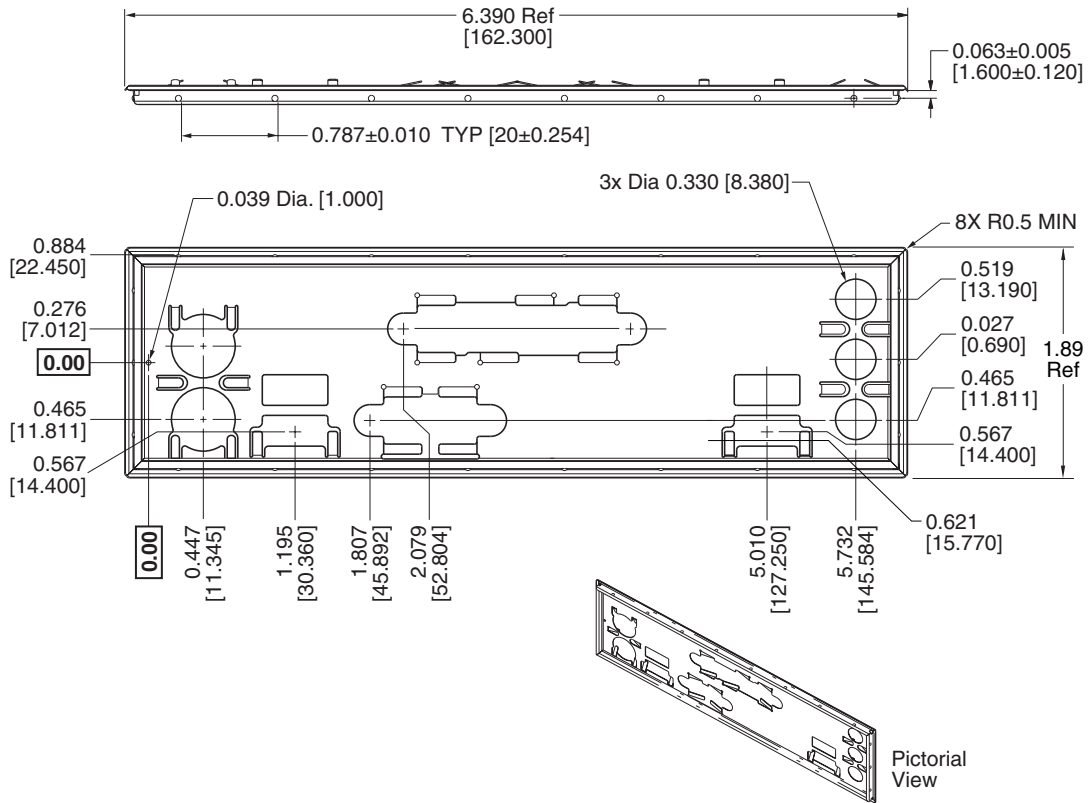

OM12868

Figure 21. I/O Shield Dimensions (for boards with neither the LAN Subsystem nor USB 2.0)

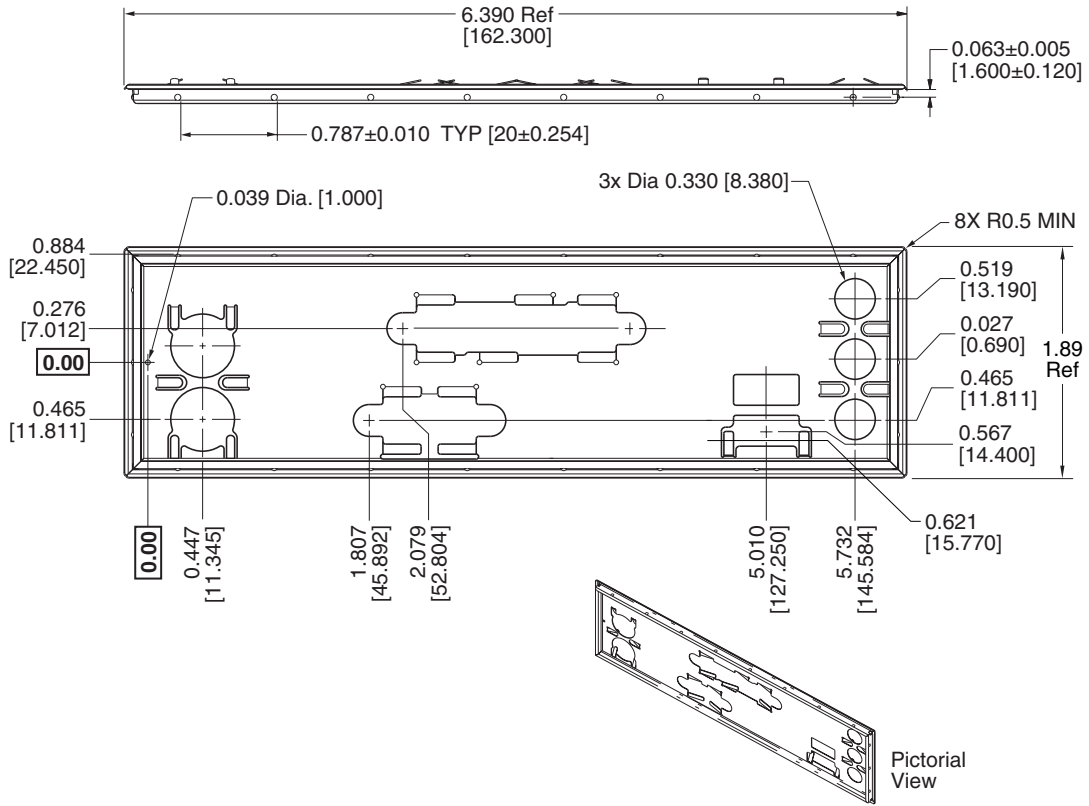

OM12867

Figure 22. I/O Shield Dimensions (for boards without the LAN Subsystem, but with USB 2.0)

2.11 Electrical Considerations

2.11.1 Power Consumption

Table 49 lists voltage and current measurements for a computer that contains the D845BG/D845PT board and the following:

- 2.2 GHz Intel Pentium 4 processor with a 256 KB cache
- 32 MB AGP card
- 512 MB DDR SDRAM
- 3.5-inch diskette drive
- 10.2 GB IDE hard disk drive
- 52 X IDE CD-ROM drive

This information is provided only as a guide for calculating approximate power usage with additional resources added.

Values for the Windows XP desktop mode are measured at 1024 x 768 x true color (32 bit) and 85 Hz refresh rate. AC watts are measured with the computer is connected to a typical 300 W power supply, at nominal input voltage and frequency, with a true RMS wattmeter at the line input.



NOTE

Actual system power consumption depends upon system configuration. The power supply should comply with the recommendations found in the ATX/ATX12V Power Supply Design Guide, Version 1.1 (see Section 1.5 on page 19 for specification information).

Table 49. Power Usage

Mode	AC Power	DC Current at:				
		+3.3 V	+5 V	+12 V	-12 V	+5 VSB
ACPI S0	56.1 W	4.210 A	0.175 A	1.234 A	0.75 A	0.316 A
ACPI S1	44.9 W	2.604 A	0.128 A	1.230 A	0.75 A	0.260 A
ACPI S3	3.9 W	0.004 A	0.003 A	0.003 A	0.004 A	0.411 A

2.11.2 Add-in Board Considerations

The D845BG and D845PT boards are designed to provide 2 A (average) of +5 V current for each add-in board. The total +5 V current draw for add-in boards is as follows:

- For a fully loaded D845BG board (all seven expansion slots filled), the total +5 V current draw must not exceed 14 A.
- For a fully loaded D845PT board (all four expansion slots filled), the total +5 V current draw must not exceed 8 A.

2.11.3 Standby Current Requirements



CAUTION

If the standby current necessary to support multiple wake events from the PCI and/or USB buses exceeds power supply capacity, the D845BG and D845PT boards may lose register settings stored in memory, etc. Calculate the standby current requirements using the steps described below.

Power supplies used with the D845BG and D845PT boards must be able to provide enough standby current to support the Instantly Available PC (ACPI S3 sleep state) configuration as outlined in Table 50 below.

Values are determined by specifications such as PCI 2.2. Actual measured values may vary.

To estimate the amount of standby current required for a particular system configuration, standby current requirements of all installed components must be added to determine the total standby current requirement. Refer to the descriptions in Table 50 and review the following steps.

1. Note the total D845BG or D845PT board standby current requirement.
2. Add to that the total PS/2 port standby current requirement if a wake-enabled device is connected.
3. Add, from the PCI 2.2 slots (wake enabled) row, the total number of wake-enabled devices installed (PCI and AGP) and multiply by the standby current requirement.
4. Add, from the PCI 2.2 slots (nonwake enabled) row, the total number of wake-enabled devices installed (PCI and AGP) and multiply by the standby current requirement.
5. Add all additional wake-enabled devices' and nonwake-enabled devices' standby current requirements as applicable.
6. Add all the required current totals from steps 1 through 5 to determine the total estimated standby current power supply requirement.

Table 50. Standby Current Requirements

Instantly Available PC Current Support (Estimated for Integrated Board Components)	Description	Standby Current Requirements (mA)
	Total for D845BG board	395
Instantly Available PC Stand-by Current Support	PS/2 ports (Note)	345
	PCI 2.2 slots (wake enabled)	375
<ul style="list-style-type: none"> • Estimated for add-on components • Add to Instantly Available PC total current requirement 	PCI 2.2 slots (nonwake enabled)	20
	CNR (Note)	375
	USB ports (Note)	500
(See instructions above)		

Note: Dependent upon system configuration

 **NOTE**

IBM PS/2 Port Specification (Sept 1991) states:

- 275 mA for keyboard
- 70 mA for the mouse (nonwake-enabled device)

PCI/AGP requirements are calculated by totaling the following:

- One wake-enabled device @ 375 mA, plus
- Five nonwake-enabled devices @ 20 mA each, plus

USB requirements are calculated as:

- One wake-enabled device @ 500 mA
- USB hub @ 100 mA
- Three USB nonwake-enabled devices connected @ 2.5 mA each

 **NOTE**

Both USB ports are capable of providing up to 500 mA during normal G0/S0 operation. Only one USB port will support up to 500 mA of stand-by-current (wake-enabled device) during G1/S3 suspended operation. The other port may provide up to 7.5 mA (three nonwake-enabled devices.) during G1/S3 suspended operation.

2.11.4 Fan Connector Current Capability

Table 51 lists the current capability of the fan connectors on the D845BG and D845PT boards.

Table 51. Fan Connector Current Capability

Fan Connector	Maximum Available Current
Processor fan	1.00 A
Front chassis fan	0.50 A
Rear chassis fan	0.35 A

2.11.5 Power Supply Considerations

 **CAUTION**

The +5 V standby line for the power supply must be capable of providing adequate +5 V standby current. Failure to do so can damage the power supply. The total amount of standby current required depends on the wake devices supported and manufacturing options. Refer to Section 2.11.3 on page 82 for additional information.

System integrators should refer to the power usage values listed in Table 49 when selecting a power supply for use with the D845BG or D845PT boards.

Measurements account only for current sourced by the D845BG or D845PT boards while running in idle modes of the started operating systems.

Additional power required will depend on configurations chosen by the integrator.

The power supply must comply with the following recommendations found in the indicated sections of the ATX form factor specification.

- The potential relation between 3.3 VDC and +5 VDC power rails (Section 4.2)
- The current capability of the +5 VSB line (Section 4.2.1.2)
- All timing parameters (Section 4.2.1.3)
- All voltage tolerances (Section 4.2.2)

For information about

The ATX form factor specification

Refer toSection 1.5, page 19

2.12 Thermal Considerations

**CAUTION**

Ensure that the ambient temperature does not exceed the board's maximum operating temperature. Failure to do so could cause components to exceed their maximum case temperature and malfunction. For information about the maximum operating temperature, see the environmental specifications in Section 2.14.

**CAUTION**

Ensure that proper airflow is maintained in the processor voltage regulator circuit. Failure to do so may result in damage to the voltage regulator circuit. The processor voltage regulator area (item A in Figure 23) can reach a temperature of up to 85 °C in an open chassis.

Figure 23 shows the locations of the localized high temperature zones.

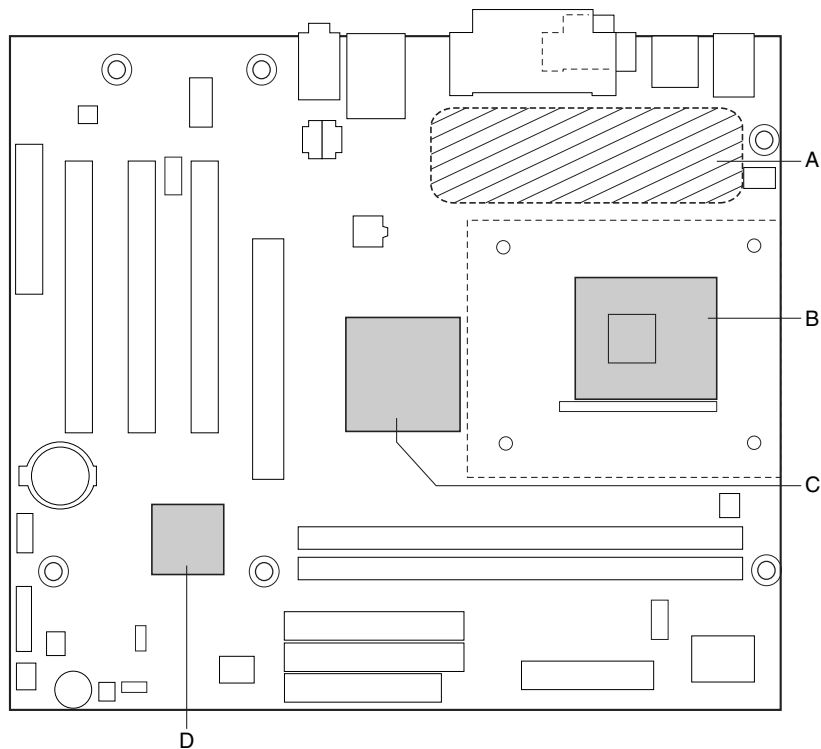

OM12995

- A Processor voltage regulator area
- B Processor
- C Intel 82845 MCH
- D Intel 82801BA ICH2

Figure 23. Localized High Temperature Zones

Table 52 provides maximum case temperatures for D845BG/D845PT board components that are sensitive to thermal changes. The operating temperature, current load, or operating frequency could affect case temperatures. Maximum case temperatures are important when considering proper airflow to cool the D845BG/D845PT boards.

Table 52. Thermal Considerations for Components

Component	Maximum Case Temperature
Intel Pentium 4 processor	For processor case temperature, see processor datasheets and processor specification updates
Intel 82845 MCH	83 °C (under bias)
Intel 82801BA ICH2	109 °C (under bias)

For information about	Refer to
Intel Pentium 4 processor datasheets and specification updates	Section 1.3, page 18

2.13 Reliability

The Mean Time Between Failures (MTBF) prediction is calculated using component and subassembly random failure rates. The calculation is based on the Bellcore Reliability Prediction Procedure, TR-NWT-000332, Issue 4, September 1991. The MTBF prediction is used to estimate repair rates and spare parts requirements.

The MTBF data is calculated from predicted data at 55 °C. The MTBF calculations for the boards are as follows:

- D845BG board MTBF: 140818.2951 hours
- D845PT board MTBF: 143991.3836 hours

2.14 Environmental

Table 53 lists the environmental specifications for the D845BG and D845PT boards.

Table 53. D845BG/D845PT Board Environmental Specifications

Parameter	Specification		
Temperature			
Non-Operating	-40 °C to +70 °C		
Operating	0 °C to +55 °C		
Shock			
Unpackaged	50 g trapezoidal waveform		
	Velocity change of 170 inches/second		
Packaged	Half sine 2 millisecond		
	Product Weight (pounds)	Free Fall (inches)	Velocity Change (inches/sec)
	<20	36	167
	21-40	30	152
	41-80	24	136
	81-100	18	118
Vibration			
Unpackaged	5 Hz to 20 Hz: 0.01 g ² Hz sloping up to 0.02 g ² Hz		
	20 Hz to 500 Hz: 0.02 g ² Hz (flat)		
Packaged	10 Hz to 40 Hz: 0.015 g ² Hz (flat)		
	40 Hz to 500 Hz: 0.015 g ² Hz sloping down to 0.00015 g ² Hz		

2.15 Regulatory Compliance

This section describes the D845BG and D845PT boards' compliance with U.S. and international safety and electromagnetic compatibility (EMC) regulations.

2.15.1 Safety Regulations

Table 54 lists the safety regulations the D845BG and D845PT boards comply with when correctly installed in a compatible host system.

Table 54. Safety Regulations

Regulation	Title
CSA C22.2 No. 60950/ UL 60950, 3 rd Edition, 2000	Bi-National Standard for Safety of Information Technology Equipment including Electrical Business Equipment. (USA and Canada)
EN 60950, 2 nd Edition, 1992 (with Amendments 1, 2, 3, and 4)	The Standard for Safety of Information Technology Equipment including Electrical Business Equipment. (European Union)
IEC 60950, 2 nd Edition, 1991 (with Amendments 1, 2, 3, and 4)	The Standard for Safety of Information Technology Equipment including Electrical Business Equipment. (International)
EMKO-TSE (74-SEC) 207/94	Summary of Nordic deviations to EN 60950. (Norway, Sweden, Denmark, and Finland)

2.15.2 EMC Regulations

Table 55 lists the EMC regulations the D845BG and D845PT boards comply with when correctly installed in a compatible host system.

Table 55. EMC Regulations

Regulation	Title
FCC (Class B)	Title 47 of the Code of Federal Regulations, Parts 2 and 15, Subpart B, Radio Frequency devices. (USA)
ICES-003 (Class B)	Interference-Causing Equipment Standard, Digital Apparatus. (Canada)
EN55022: 1998 (Class B)	Limits and methods of measurement of Radio Interference Characteristics of Information Technology Equipment. (European Union)
EN55024: 1998	Information Technology Equipment – Immunity Characteristics Limits and methods of measurement. (European Union)
AS/NZS 3548 (Class B)	Australian Communications Authority, Standard for Electromagnetic Compatibility. (Australia and New Zealand)
CISPR 22, 3 rd Edition (Class B)	Limits and methods of measurement of Radio Disturbance Characteristics of Information Technology Equipment. (International)
CISPR 24: 1997	Information Technology Equipment – Immunity Characteristics – Limits and Methods of Measurements. (International)

2.15.3 Product Certification Markings (Board Level)

The D845BG and D845PT boards have the following product certification markings:

- UL joint US/Canada Recognized Component mark: Consists of lower case c followed by a stylized backward UR and followed by a small US. Includes adjacent UL file number for Intel desktop boards: E210882 (component side).
- FCC Declaration of Conformity logo mark for Class B equipment; to include Intel name and D845BG and D845PT model designation (solder side).
- CE mark: Declaring compliance to European Union (EU) EMC directive (89/336/EEC) and Low Voltage directive (73/23/EEC) (component side). The CE mark should also be on the shipping container.
- Australian Communications Authority (ACA) C-Tick mark: consists of a stylized C overlaid with a check (tick) mark (component side), followed by Intel supplier code number, N-232. The C-tick mark should also be on the shipping container.
- Korean EMC certification logo mark: consists of MIC lettering within a stylized elliptical outline.
- Printed wiring board manufacturer's recognition mark: consists of a unique UL recognized manufacturer's logo, along with a flammability rating (94V-0) (solder side).
- PB part number: Intel bare circuit board part number (solder side). Also includes SKU number starting with AA followed by additional alphanumeric characters.
 - For the D845BG board, the PB number A66960-003.
 - For the D845PT board, the PB number is A67346-003.
- Battery "+ Side Up" marking: located on the component side of the board in close proximity to the battery holder.

3 Overview of BIOS Features

What This Chapter Contains

3.1	Introduction.....	91
3.2	BIOS Flash Memory Organization	92
3.3	Resource Configuration	92
3.4	System Management BIOS (SMBIOS)	93
3.5	Legacy USB Support	93
3.6	BIOS Updates	94
3.7	Recovering BIOS Data	95
3.8	Boot Options.....	96
3.9	Fast Booting Systems with Intel® Rapid BIOS Boot.....	96
3.10	BIOS Security Features.....	98

3.1 Introduction

The D845BG and D845PT boards use an Intel/AMI BIOS that is stored in the Firmware Hub (FWH) and can be updated using a disk-based program. The FWH contains the BIOS Setup program, POST, the PCI auto-configuration utility, and Plug and Play support.

The D845BG and D845PT boards support system BIOS shadowing, allowing the BIOS to execute from 64-bit onboard write-protected system memory.

The BIOS displays a message during POST identifying the type of BIOS and a revision code. The initial production BIOSs are identified as PT84510A.86A.

When the D845BG or D845PT board's jumper is set to configuration mode and the computer is powered-up, the BIOS compares the CPU version and the microcode version in the BIOS and reports if the two match.

For information about	Refer to
------------------------------	-----------------

The D845BG and D845PT boards' compliance level with Plug and Play

Section 1.5, page 19

3.2 BIOS Flash Memory Organization

The Intel 82802AB Firmware Hub (FWH) includes a 4 Mbit (512 KB) symmetrical flash memory device. Internally, the device is grouped into eight 64-KB blocks that are individually erasable, lockable, and unlockable.

3.3 Resource Configuration

3.3.1 PCI Autoconfiguration

The BIOS can automatically configure PCI devices. PCI devices may be onboard or add-in cards. Autoconfiguration lets a user insert or remove PCI cards without having to configure the system. When a user turns on the system after adding a PCI card, the BIOS automatically configures interrupts, the I/O space, and other system resources. Any interrupts set to Available in Setup are considered to be available for use by the add-in card. Autoconfiguration information is stored in ESCD format.

For information about the versions of PCI and Plug and Play supported by the BIOS, see Section 1.5.

3.3.2 PCI IDE Support

If you select Auto in the BIOS Setup program, the BIOS automatically sets up the two PCI IDE connectors with independent I/O channel support. The IDE interface supports hard drives up to ATA-66/100 and recognizes any ATAPI compliant devices, including CD-ROM drives, tape drives, and Ultra DMA drives (see Section 1.5 for the supported version of ATAPI). The BIOS determines the capabilities of each drive and configures them to optimize capacity and performance. To take advantage of the high capacities typically available today, hard drives are automatically configured for Logical Block Addressing (LBA) and to PIO Mode 3 or 4, depending on the capability of the drive. You can override the auto-configuration options by specifying manual configuration in the BIOS Setup program.

To use ATA-66/100 features the following items are required:

- An ATA-66/100 peripheral device
- An ATA-66/100 compatible cable
- ATA-66/100 operating system device drivers

NOTE

ATA-66/100 compatible cables are backward compatible with drives using slower IDE transfer protocols. If an ATA-66/100 disk drive and a disk drive using any other IDE transfer protocol are attached to the same cable, the maximum transfer rate between the drives is reduced to that of the slowest device.

NOTE

Do not connect an ATA device as a slave on the same IDE cable as an ATAPI master device. For example, do not connect an ATA hard drive as a slave to an ATAPI CD-ROM drive.

3.4 System Management BIOS (SMBIOS)

SMBIOS is a Desktop Management Interface (DMI) compliant method for managing computers in a managed network.

The main component of SMBIOS is the Management Information Format (MIF) database, which contains information about the computing system and its components. Using SMBIOS, a system administrator can obtain the system types, capabilities, operational status, and installation dates for system components. The MIF database defines the data and provides the method for accessing this information. The BIOS enables applications such as third-party management software to use SMBIOS. The BIOS stores and reports the following SMBIOS information:

- BIOS data, such as the BIOS revision level
- Fixed-system data, such as peripherals, serial numbers, and asset tags
- Resource data, such as memory size, cache size, and processor speed
- Dynamic data, such as event detection and error logging

Non-Plug and Play operating systems, such as Windows NT, require an additional interface for obtaining the SMBIOS information. The BIOS supports an SMBIOS table interface for such operating systems. Using this support, an SMBIOS service-level application running on a non-Plug and Play operating system can obtain the SMBIOS information.

For information about	Refer to
The D845BG and D845PT boards' compliance level with SMBIOS	Section 1.5, page 19

3.5 Legacy USB Support

Legacy USB support enables USB devices such as keyboards, mice, and hubs to be used even when the operating system's USB drivers are not yet available. Legacy USB support is used to access the BIOS Setup program, and to install an operating system that supports USB. By default, Legacy USB support is set to Enabled.

Legacy USB support operates as follows:

1. When you apply power to the computer, legacy support is disabled.
2. POST begins.
3. Legacy USB support is enabled by the BIOS allowing you to use a USB keyboard to enter and configure the BIOS Setup program and the maintenance menu.
4. POST completes.

5. The operating system loads. While the operating system is loading, USB keyboards and mice are recognized and may be used to configure the operating system. (Keyboards and mice are not recognized during this period if Legacy USB support was set to Disabled in the BIOS Setup program.)
6. After the operating system loads the USB drivers, all legacy and non-legacy USB devices are recognized by the operating system, and Legacy USB support from the BIOS is no longer used.

To install an operating system that supports USB, verify that Legacy USB support in the BIOS Setup program is set to Enabled and follow the operating system's installation instructions.

 **NOTE**

Legacy USB support is for keyboards, mice, and hubs only. Other USB devices are not supported in legacy mode.

3.6 BIOS Updates

The BIOS can be updated using either of the following utilities, which are available on the Intel World Wide Web site:

- Intel® Express BIOS Update utility, which enables automated updating while in the Windows environment. Using this utility, the BIOS can be updated from a file on a hard disk, a 1.44 MB diskette, or a CD-ROM, or from the file location on the Web.
- Intel® Flash Memory Update Utility, which requires creation of a boot diskette and manual rebooting of the system. Using this utility, the BIOS can be updated from a file on a 1.44 MB diskette (from a legacy diskette drive or an LS-120 diskette drive) or a CD-ROM.

Both utilities support the following BIOS maintenance functions:

- Verifying that the updated BIOS matches the target system to prevent accidentally installing an incompatible BIOS.
- Updating both the BIOS boot block and the main BIOS. This process is fault tolerant to prevent boot block corruption.
- Updating the BIOS boot block separately.
- Changing the language section of the BIOS.
- Updating replaceable BIOS modules, such as the video BIOS module.
- Inserting a custom splash screen.

 **NOTE**

Review the instructions distributed with the upgrade utility before attempting a BIOS update.

For information about

The Intel World Wide Web site

Refer to

Section 1.3, page 18

3.6.1 Language Support

The BIOS Setup program and help messages are supported in five languages: US English, German, Italian, French, and Spanish. The default language is US English, which is present unless another language is selected in the BIOS Setup program.

3.6.2 Custom Splash Screen

During POST, an Intel splash screen is displayed by default. This splash screen can be replaced with a custom splash screen. A utility is available from Intel to assist with creating a custom splash screen. The custom splash screen can be programmed into the flash memory using the BIOS upgrade utility. Information about this capability is available on the Intel Support World Wide Web site.

For information about	Refer to
The Intel World Wide Web site	Section 1.3, page 18

3.7 Recovering BIOS Data

Some types of failure can destroy the BIOS. For example, the data can be lost if a power outage occurs while the BIOS is being updated in flash memory. The BIOS can be recovered from a diskette using the BIOS recovery mode. When recovering the BIOS, be aware of the following:

- Because of the small amount of code available in the non-erasable boot block area, there is no video support. You can only monitor this procedure by listening to the speaker or looking at the diskette drive LED.
- The recovery process may take several minutes; larger BIOS flash memory devices require more time.
- Two beeps and the end of activity in the diskette drive indicate successful BIOS recovery.
- A series of continuous beeps indicates a failed BIOS recovery.

To create a BIOS recovery diskette, a bootable diskette must be created and the BIOS update files copied to it. BIOS upgrades and the Intel Flash Memory Update Utility are available from Intel Customer Support through the Intel World Wide Web site.

NOTE

Even if the computer is configured to boot from an LS-120 diskette (in the Setup program's Removable Devices submenu), the BIOS recovery diskette must be a standard 1.44 MB diskette not a 120 MB diskette.

For information about	Refer to
The BIOS recovery mode jumper settings	Section 2.9.1, page 75
The Boot menu in the BIOS Setup program	Section 4.7, page 117
Contacting Intel customer support	Section 1.3, page 18

3.8 Boot Options

In the BIOS Setup program, the user can choose to boot from a diskette drive, hard drives, CD-ROM, or the network. The default setting is for the diskette drive to be the first boot device, the hard drive second, and the ATAPI CD-ROM third. The fourth device is disabled.

3.8.1 CD-ROM and Network Boot

Bootting from CD-ROM is supported in compliance to the El Torito bootable CD-ROM format specification. Under the Boot menu in the BIOS Setup program, ATAPI CD-ROM is listed as a boot device. Boot devices are defined in priority order. Accordingly, if there is not a bootable CD in the CD-ROM drive, the system will attempt to boot from the next defined drive.

The network can be selected as a boot device. This selection allows booting from the onboard LAN or a network add-in card with a remote boot ROM installed.

For information about	Refer to
The El Torito specification	Section 1.5, page 19

3.8.2 Booting Without Attached Devices

For use in embedded applications, the BIOS has been designed so that after passing the POST, the operating system loader is invoked even if the following devices are not present:

- Video adapter
- Keyboard
- Mouse

3.9 Fast Booting Systems with Intel® Rapid BIOS Boot

These factors affect system boot speed:

- Selecting and configuring peripherals properly
- Using an optimized BIOS, such as the Intel Rapid BIOS

3.9.1 Peripheral Selection and Configuration

The following techniques help improve system boot speed:

- Choose a hard drive with parameters such as “power-up to data ready” less than eight seconds, that minimize hard drive startup delays.
- Select a CD-ROM drive with a fast initialization rate. This rate can influence POST execution time.
- Eliminate unnecessary add-in adapter features, such as logo displays, screen repaints, or mode changes in POST. These features may add time to the boot process.
- Try different monitors. Some monitors initialize and communicate with the BIOS more quickly, which enables the system to boot more quickly.

3.9.2 Intel Rapid BIOS Boot

Use of the following BIOS Setup program settings reduces the POST execution time.

In the Boot Menu:

- Set the hard disk drive as the first boot device. As a result, the POST does not first seek a diskette drive, which saves about one second from the POST execution time.
- Disable Quiet Boot, which eliminates display of the logo splash screen. This could save several seconds of painting complex graphic images and changing video modes.
- Enabled Intel Rapid BIOS Boot. This feature bypasses memory count and the search for a diskette drive.

In the Peripheral Configuration submenu, disable the LAN device if it will not be used. This can reduce up to four seconds of option ROM boot time.

NOTE

It is possible to optimize the boot process to the point where the system boots so quickly that the Intel logo screen (or a custom logo splash screen) will not be seen. Monitors and hard disk drives with minimum initialization times can also contribute to a boot time that might be so fast that necessary logo screens and POST messages cannot be seen.

This boot time may be so fast that some drives might be not be initialized at all. If this condition should occur, it is possible to introduce a programmable delay ranging from three to 30 seconds (using the Hard Disk Pre-Delay feature of the Advanced Menu in the IDE Configuration Submenu of the BIOS Setup program).

For information about	Refer to
IDE Configuration Submenu in the BIOS Setup program	Section 4.4.4, page 108

3.10 BIOS Security Features

The BIOS includes security features that restrict access to the BIOS Setup program and who can boot the computer. A supervisor password and a user password can be set for the BIOS Setup program and for booting the computer, with the following restrictions:

- The supervisor password gives unrestricted access to view and change all the Setup options in the BIOS Setup program. This is the supervisor mode.
- The user password gives restricted access to view and change Setup options in the BIOS Setup program. This is the user mode.
- If only the supervisor password is set, pressing the <Enter> key at the password prompt of the BIOS Setup program allows the user restricted access to Setup.
- If both the supervisor and user passwords are set, users can enter either the supervisor password or the user password to access Setup. Users have access to Setup respective to which password is entered.
- Setting the user password restricts who can boot the computer. The password prompt will be displayed before the computer is booted. If only the supervisor password is set, the computer boots without asking for a password. If both passwords are set, the user can enter either password to boot the computer.

Table 56 shows the effects of setting the supervisor password and user password. This table is for reference only and is not displayed on the screen.

Table 56. Supervisor and User Password Functions

Password Set	Supervisor Mode	User Mode	Setup Options	Password to Enter Setup	Password During Boot
Neither	Can change all options <small>(Note)</small>	Can change all options <small>(Note)</small>	None	None	None
Supervisor only	Can change all options	Can change a limited number of options	Supervisor Password	Supervisor	None
User only	N/A	Can change all options	Enter Password Clear User Password	User	User
Supervisor and user set	Can change all options	Can change a limited number of options	Supervisor Password Enter Password	Supervisor or user	Supervisor or user

Note: If no password is set, any user can change all Setup options.

For information about

Setting user and supervisor passwords

Refer to

Section 4.5, page 114

4 BIOS Setup Program

What This Chapter Contains

4.1	Introduction.....	99
4.2	Maintenance Menu.....	100
4.3	Main Menu.....	102
4.4	Advanced Menu.....	103
4.5	Security Menu.....	114
4.6	Power Menu.....	115
4.7	Boot Menu.....	117
4.8	Exit Menu.....	120

4.1 Introduction

The BIOS Setup program can be used to view and change the BIOS settings for the computer. The BIOS Setup program is accessed by pressing the <F2> key after the Power-On Self-Test (POST) memory test begins and before the operating system boot begins. The menu bar is shown below.

Maintenance	Main	Advanced	Security	Power	Boot	Exit
-------------	------	----------	----------	-------	------	------

Table 57 lists the BIOS Setup program menu features.

Table 57. BIOS Setup Program Menu Bar

Maintenance	Main	Advanced	Security	Power	Boot	Exit
Clears passwords and BIS credentials and enables extended configuration mode	Allocates resources for hardware components	Configures advanced features available through the chipset	Sets passwords and security features	Configures power management features	Selects boot options and power supply controls	Saves or discards changes to Setup program options

For information about

Boot Integrity Services (BIS)

Refer to

Section 1.5, page 19

 **NOTE**

In this chapter, all examples of the BIOS Setup program menu bar include the maintenance menu; however, the maintenance menu is displayed only when the board is in configuration mode. Section 2.9 on page 75 tells how to put the board in configuration mode.

Table 58 lists the function keys available for menu screens.

Table 58. BIOS Setup Program Function Keys

BIOS Setup Program Function Key	Description
<←> or <→>	Selects a different menu screen (Moves the cursor left or right)
<↑> or <↓>	Selects an item (Moves the cursor up or down)
<Tab>	Selects a field (Not implemented)
<Enter>	Executes command or selects the submenu
<F9>	Load the default configuration values for the current menu
<F10>	Save the current values and exits the BIOS Setup program
<Esc>	Exits the menu

4.2 Maintenance Menu

To access this menu, select Maintenance on the menu bar at the top of the screen.

Maintenance	Main	Advanced	Security	Power	Boot	Exit
Extended Configuration						

The menu shown in Table 59 is for clearing Setup passwords and enabling extended configuration mode. Setup only displays this menu in configuration mode. See Section 2.9 on page 75 for configuration mode setting information.

Table 59. Maintenance Menu

Feature	Options	Description
Clear All Passwords	<ul style="list-style-type: none"> • Yes (default) • No 	Clears the user and supervisor passwords.
Clear BIS Credentials	<ul style="list-style-type: none"> • Yes (default) • No 	Clears the Wired for Management Boot Integrity Service (BIS) credentials.
Extended Configuration	<ul style="list-style-type: none"> • Default (default) • User-Defined 	Invokes the Extended Configuration submenu.
CPU Information	No options	Displays CPU Information.
CPU Stepping Signature	No options	Displays CPU's Stepping Signature.
CPU Microcode Update Revision	No options	Displays CPU's Microcode Update Revision.

4.2.1 Extended Configuration Submenu

To access this submenu, select Maintenance on the menu bar and then Extended Configuration.

Maintenance	Main	Advanced	Security	Power	Boot	Exit
Extended Configuration						

The submenu represented by Table 60 is for setting video memory cache mode. This submenu becomes available when User Defined is selected under Extended Configuration.

Table 60. Extended Configuration Submenu

Feature	Options	Description
Extended Configuration	<ul style="list-style-type: none"> Default (default) User Defined 	User Defined allows setting memory control and video memory cache mode. If selected here, will also display in the Advanced Menu as: "Extended Menu: <i>Used</i> ."
Video Memory Cache Mode	<ul style="list-style-type: none"> USWC UC (default) 	<p>Selects Uncacheable Speculative Write-Combining (USWC) video memory cache mode. Full 32 byte contents of the Write Combining buffer are written to memory as required. Cache lookups are not performed. Both the video driver and the application must support Write Combining.</p> <p>Selects UnCacheable (UC) video memory cache mode. This setting identifies the video memory range as uncacheable by the processor. Memory writes are performed in program order. Cache lookups are not performed. Well suited for applications not supporting Write Combining.</p>

4.3 Main Menu

To access this menu, select Main on the menu bar at the top of the screen.

Maintenance	Main	Advanced	Security	Power	Boot	Exit
-------------	-------------	----------	----------	-------	------	------

Table 61 describes the Main menu. This menu reports processor and memory information and is for configuring the system date and system time.

Table 61. Main Menu

Feature	Options	Description
BIOS Version	No options	Displays the version of the BIOS.
Processor Type	No options	Displays processor type.
Processor Speed	No options	Displays processor speed.
System Bus Speed	No options	Displays the system bus speed.
Cache RAM	No options	Displays the size of second-level cache and whether it is ECC-capable.
Total Memory	No options	Displays the total amount of RAM.
Memory Bank 0 Memory Bank 1	No options	Displays the amount and type of RAM in the memory banks.
Language	<ul style="list-style-type: none"> • English (default) • Español • Deutsch • Italiano • Français 	Selects the current default language used by the BIOS.
Memory Configuration	<ul style="list-style-type: none"> • Non-ECC • ECC (default) 	Allows the user to enable error reporting if the system and all installed memory support ECC. If non-ECC memory is installed, BIOS will detect and change the setting to Non-ECC.
System Time	Hour, minute, and second	Specifies the current time.
System Date	Day of week Month/day/year	Specifies the current date.

4.4 Advanced Menu

To access this menu, select Advanced on the menu bar at the top of the screen.

Maintenance	Main	Advanced	Security	Power	Boot	Exit
		PCI Configuration				
		Boot Configuration				
		Peripheral Configuration				
		IDE Configuration				
		Diskette Configuration				
		Event Log Configuration				
		Video Configuration				

Table 62 describes the Advanced Menu. This menu is used for setting advanced features that are available through the chipset.

Table 62. Advanced Menu

Feature	Options	Description
Extended Configuration	No options	If <i>Used</i> is displayed, <i>User-Defined</i> has been selected in Extended Configuration under the Maintenance Menu.
PCI Configuration	Select to display submenu	Configures individual PCI slot's IRQ priority.
Boot Configuration	Select to display submenu	Configures Plug and Play and the Numlock key, and resets configuration data.
Peripheral Configuration	Select to display submenu	Configures peripheral ports and devices.
IDE Configuration	Select to display submenu	Specifies type of connected IDE devices.
Diskette Configuration	Select to display submenu	Configures the diskette drive.
Event Log Configuration	Select to display submenu	Configures event logging.
Video Configuration	Select to display submenu	Configures video features.

4.4.1 PCI Configuration Submenu

To access this submenu, select Advanced on the menu bar and then PCI Configuration.

Maintenance	Main	Advanced	Security	Power	Boot	Exit
		PCI Configuration				
		Boot Configuration				
		Peripheral Configuration				
		IDE Configuration				
		Diskette Configuration				
		Event Log Configuration				
		Video Configuration				

The submenu shown in Table 63 is used to configure the IRQ priority of PCI slots individually.

Table 63. PCI Configuration Submenu

Feature	Options	Description
PCI Slot1 IRQ Priority (Note 1)	<ul style="list-style-type: none"> • Auto (default) • 9 • 10 • 11 	Allows selection of IRQ priority for PCI bus connector 1.
PCI Slot2 IRQ Priority (Note 1)	<ul style="list-style-type: none"> • Auto (default) • 9 • 10 • 11 	Allows selection of IRQ priority for PCI bus connector 2.
PCI Slot3 IRQ Priority (Note 1)	<ul style="list-style-type: none"> • Auto (default) • 9 • 10 • 11 	Allows selection of IRQ priority for PCI bus connector 3.
PCI Slot4 IRQ Priority (Note 1 and Note 2)	<ul style="list-style-type: none"> • Auto (default) • 9 • 10 • 11 	Allows selection of IRQ priority for PCI bus connector 4.
PCI Slot5 IRQ Priority (Note 1 and Note 2)	No options	Displays the IRQ for PCI bus connector 5. This IRQ will be the same as the setting selected for PCI bus connector 1. (PCI bus connectors 1 and 5 share the same interrupt.)
PCI Slot6 IRQ Priority (Note 1 and Note 2)	No options	Displays the IRQ for PCI bus connector 6. This IRQ will be the same as the setting selected for PCI bus connector 4. (PCI bus connectors 4 and 6 share the same interrupt.)

Notes:

1. Additional interrupts may be available if certain onboard devices (such as the serial and parallel ports) are disabled.
2. This option appears only on the D845BG board.

4.4.2 Boot Configuration Submenu

To access this submenu, select Advanced on the menu bar and then Boot Configuration.

Maintenance	Main	Advanced	Security	Power	Boot	Exit
		PCI Configuration				
		Boot Configuration				
		Peripheral Configuration				
		IDE Configuration				
		Diskette Configuration				
		Event Log Configuration				
		Video Configuration				

The submenu represented by Table 64 is for setting Plug and Play options, resetting configuration data, and the power-on state of the Numlock key.

Table 64. Boot Configuration Submenu

Feature	Options	Description
Plug & Play O/S	<ul style="list-style-type: none"> • No (default) • Yes 	<p>Specifies if manual configuration is desired.</p> <p><i>No</i> lets the BIOS configure all devices. This setting is appropriate when using a Plug and Play operating system.</p> <p><i>Yes</i> lets the operating system configure Plug and Play devices not required to boot the system. This option is available for use during lab testing.</p>
Reset Config Data	<ul style="list-style-type: none"> • No (default) • Yes 	<p><i>No</i> does not clear the PCI/PnP configuration data stored in flash memory on the next boot.</p> <p><i>Yes</i> clears the PCI/PnP configuration data stored in flash memory on the next boot.</p>
Numlock	<ul style="list-style-type: none"> • Off • On (default) 	<p>Specifies the power-on state of the Numlock feature on the numeric keypad of the keyboard.</p>

4.4.3 Peripheral Configuration Submenu

To access this submenu, select Advanced on the menu bar and then Peripheral Configuration.

Maintenance	Main	Advanced	Security	Power	Boot	Exit
		PCI Configuration				
		Boot Configuration				
		Peripheral Configuration				
		IDE Configuration				
		Diskette Configuration				
		Event Log Configuration				
		Video Configuration				

The submenu represented in Table 65 is used for configuring computer peripherals.

Table 65. Peripheral Configuration Submenu

Feature	Options	Description
Serial Port A	<ul style="list-style-type: none"> Disabled Enabled Auto (default) 	Configures serial port A. <i>Auto</i> assigns the first free COM port, normally COM1, the address 3F8h, and the interrupt IRQ4. An * (asterisk) displayed next to an address indicates a conflict with another device.
Base I/O address (This feature is present only when Serial Port A is set to <i>Enabled</i>)	<ul style="list-style-type: none"> 3F8 (default) 2F8 3E8 2E8 	Specifies the base I/O address for serial port A.
Interrupt (This feature is present only when Serial Port A is set to <i>Enabled</i>)	<ul style="list-style-type: none"> IRQ 3 IRQ 4 (default) 	Specifies the interrupt for serial port A.
Serial Port B	<ul style="list-style-type: none"> Disabled Enabled Auto (default) 	Configures serial port B. <i>Auto</i> assigns the first free COM port, normally COM 2, the address 3F8h, and the interrupt IRQ4. An * (asterisk) displayed next to an address indicates a conflict with another device.
Base I/O address (This feature is displayed only if Serial Port B is set to <i>Enabled</i>)	<ul style="list-style-type: none"> 2F8 (default) 3E8 2E8 	Specifies the base I/O address for serial port B.

continued

Table 65. Peripheral Configuration Submenu (continued)

Feature	Options	Description
Interrupt (This feature is displayed only if Serial Port B is set to <i>Enabled</i>)	<ul style="list-style-type: none"> • IRQ 3 (default) • IRQ 4 	Specifies the interrupt for serial port B.
Parallel port	<ul style="list-style-type: none"> • Disabled • Enabled • Auto (default) 	Configures the parallel port. <i>Auto</i> assigns LPT1 the address 378h and the interrupt IRQ7. An * (asterisk) displayed next to an address indicates a conflict with another device.
Mode	<ul style="list-style-type: none"> • Output Only • Bi-directional (default) • EPP • ECP 	Selects the mode for the parallel port. Not available if the parallel port is disabled. <i>Output Only</i> operates in AT ⁺ -compatible mode. <i>Bi-directional</i> operates in PS/2-compatible mode. <i>EPP</i> is Extended Parallel Port mode, a high-speed bi-directional mode. <i>ECP</i> is Enhanced Capabilities Port mode, a high-speed bi-directional mode.
Base I/O address (This feature is present only when Parallel Port is set to <i>Enabled</i>)	<ul style="list-style-type: none"> • 378 (default) • 278 	Specifies the base I/O address for the parallel port.
Interrupt (This feature is present only when Parallel Port is set to <i>Enabled</i>)	<ul style="list-style-type: none"> • IRQ 5 • IRQ 7 (default) 	Specifies the interrupt for the parallel port.
DMA (This feature is present only when Parallel Port Mode is set to <i>ECP</i>)	<ul style="list-style-type: none"> • 1 • 3 (default) 	Specifies the DMA channel.
Audio Device	<ul style="list-style-type: none"> • Disabled • Enabled (default) 	Enables or disables the onboard audio subsystem. For boards with no onboard audio subsystem, this option does not appear; however, this option does appear if a CNR card with an audio subsystem is installed.
LAN Device	<ul style="list-style-type: none"> • Disabled • Enabled (default) 	Enables or disables the onboard LAN device. For boards with no onboard LAN audio subsystem, this option will not appear; however, this option does appear if a CNR card with a LAN subsystem is installed.
Modem Device	<ul style="list-style-type: none"> • Disabled • Enabled (default) 	Enables or disables a modem device on a CNR card. This option appears only when a CNR card with a modem is installed.
Legacy USB Support	<ul style="list-style-type: none"> • Disabled • Enabled (default) 	Enables or disables Legacy USB support.

4.4.4 IDE Configuration Submenu

To access this submenu, select Advanced on the menu bar and then IDE Configuration.

Maintenance	Main	Advanced	Security	Power	Boot	Exit
		PCI Configuration				
		Boot Configuration				
		Peripheral Configuration				
		IDE Configuration				
		Diskette Configuration				
		Event Log Configuration				
		Video Configuration				

The menu represented in Table 66 is used to configure IDE device options.

Table 66. IDE Configuration Submenu

Feature	Options	Description
IDE Controller	<ul style="list-style-type: none"> • Disabled • Primary • Secondary • Both (default) 	Specifies the integrated IDE controller. <i>Primary</i> enables only the primary IDE controller. <i>Secondary</i> enables only the secondary IDE controller. <i>Both</i> enables both IDE controllers.
PCI IDE Bus Master	<ul style="list-style-type: none"> • Disabled • Enabled (default) 	Enables/disables the use of DMA for hard drive BIOS INT13 reads and writes.
Hard Disk Pre-Delay	<ul style="list-style-type: none"> • Disabled (default) • 3 Seconds • 6 Seconds • 9 Seconds • 12 Seconds • 15 Seconds • 21 Seconds • 30 Seconds 	Specifies the hard disk drive pre-delay.
Primary IDE Master	Select to display sub-menu	Reports type of connected IDE device.
Primary IDE Slave	Select to display sub-menu	Reports type of connected IDE device.
Secondary IDE Master	Select to display sub-menu	Reports type of connected IDE device.
Secondary IDE Slave	Select to display sub-menu	Reports type of connected IDE device.

4.4.4.1 Primary/Secondary IDE Master/Slave Submenus

To access these submenus, select **Advanced** on the menu bar, then **IDE Configuration**, and then the master or slave to be configured.

Maintenance	Main	Advanced	Security	Power	Boot	Exit
		PCI Configuration				
		Boot Configuration				
		Peripheral Configuration				
		IDE Configuration				
		Primary IDE Master				
		Primary IDE Slave				
		Secondary IDE Master				
		Secondary IDE Slave				
		Diskette Configuration				
		Event Log Configuration				
		Video Configuration				

There are four IDE submenus: primary master, primary slave, secondary master, and secondary slave. Table 67 shows the format of the IDE submenus. For brevity, only one example is shown.

Table 67. Primary/Secondary IDE Master/Slave Submenus

Feature	Options	Description
Drive Installed	No options	Displays the type of drive installed.
Type	<ul style="list-style-type: none"> • None • User • Auto (default) • CD-ROM • ATAPI Removable • Other ATAPI • IDE Removable 	<p>Specifies the IDE configuration mode for IDE devices.</p> <p><i>User</i> allows capabilities to be changed.</p> <p><i>Auto</i> fills-in capabilities from ATA/ATAPI device.</p>
Maximum Capacity	No options	Displays the capacity of the drive.
Multi-Sector Transfers	<ul style="list-style-type: none"> • Disabled • 2 Sectors • 4 Sectors • 8 Sectors • 16 Sectors (default) 	<p>Specifies number of sectors per block for transfers from the hard disk drive to memory.</p> <p>Check the hard disk drive's specifications for optimum setting.</p>

continued

Table 67. Primary/Secondary IDE Master/Slave Submenus (continued)

Feature	Options	Description
PIO Mode	<ul style="list-style-type: none"> • Auto (default) • Mode 0 • Mode 1 • Mode 2 • Mode 3 • Mode 4 	Specifies the PIO mode.
Ultra DMA	<ul style="list-style-type: none"> • Disabled (default) • Mode 0 • Mode 1 • Mode 2 • Mode 3 • Mode 4 • Mode 5 	Specifies the Ultra DMA mode for the drive.
Cable Detected	No options	Displays the type of cable connected to the IDE interface: 40-conductor or 80-conductor (for ATA-100 peripherals).

4.4.5 Diskette Configuration Submenu

To access this menu, select Advanced on the menu bar and then Diskette Configuration.

Maintenance	Main	Advanced	Security	Power	Boot	Exit
		PCI Configuration				
		Boot Configuration				
		Peripheral Configuration				
		IDE Configuration				
		Diskette Configuration				
		Event Log Configuration				
		Video Configuration				

The submenu represented by Table 68 is used for configuring the diskette drive.

Table 68. Diskette Configuration Submenu

Feature	Options	Description
Diskette Controller	<ul style="list-style-type: none"> • Disabled • Enabled (default) 	Disables or enables the integrated diskette controller.
Floppy A	<ul style="list-style-type: none"> • Not Installed • 360 KB 5¼" • 1.2 MB 5¼" • 720 KB 3½" • 1.44/1.25 MB 3½" (default) • 2.88 MB 3½" 	Specifies the capacity and physical size of diskette drive A.
Diskette Write Protect	<ul style="list-style-type: none"> • Disabled (default) • Enabled 	Disables or enables write protection for the diskette drive.

4.4.6 Event Log Configuration Submenu

To access this menu, select Advanced on the menu bar and then Event Log Configuration.

Maintenance	Main	Advanced	Security	Power	Boot	Exit
		PCI Configuration				
		Boot Configuration				
		Peripheral Configuration				
		IDE Configuration				
		Diskette Configuration				
		Event Log Configuration				
		Video Configuration				

The submenu represented by Table 69 is used to configure the event logging features.

Table 69. Event Log Configuration Submenu

Feature	Options	Description
Event Log	No options	Indicates if there is space available in the event log.
Event Log Validity	No options	Indicates if the contents of the event log are valid.
View Event Log	[Enter]	Displays the event log.
Clear All Event Logs	<ul style="list-style-type: none"> • No (default) • Yes 	Clears the event log after rebooting.
Event Logging	<ul style="list-style-type: none"> • Disabled • Enabled (default) 	Enables logging of events.
ECC Event Logging	<ul style="list-style-type: none"> • Disabled • Enabled (default) 	Enables logging of ECC events.
Mark Events As Read	<ul style="list-style-type: none"> • Yes (default) • No 	Marks all events as read.

4.4.7 Video Configuration Submenu

To access this menu, select Advanced on the menu bar and then Video Configuration.

Maintenance	Main	Advanced	Security	Power	Boot	Exit
		PCI Configuration				
		Boot Configuration				
		Peripheral Configuration				
		IDE Configuration				
		Diskette Configuration				
		Event Log Configuration				
		Video Configuration				

The submenu represented in Table 70 is for configuring the video features.

Table 70. Video Configuration Submenu

Feature	Options	Description
AGP Aperture Size	<ul style="list-style-type: none"> • 64 MB (default) • 256 MB 	Sets the aperture size for the AGP video controller.
Primary Video Adapter	<ul style="list-style-type: none"> • AGP (default) • PCI 	Selects primary video adapter to be used during boot.

4.5 Security Menu

To access this menu, select Security from the menu bar at the top of the screen.

Maintenance	Main	Advanced	Security	Power	Boot	Exit
-------------	------	----------	-----------------	-------	------	------

The menu represented by Table 71 is for setting passwords and security features.

Table 71. Security Menu

If no password entered previously:		
Feature	Options	Description
Supervisor Password Is	No options	Reports if there is a supervisor password set.
User Password Is	No options	Reports if there is a user password set.
Set Supervisor Password	Password can be up to seven alphanumeric characters.	Specifies the supervisor password.
Set User Password	Password can be up to seven alphanumeric characters.	Specifies the user password.
Clear User Password (Note 1)	<ul style="list-style-type: none"> • Yes (default) • No 	Clears the user password.
User Access Level (Note 2)	<ul style="list-style-type: none"> • Limited • No Access • View Only • Full (default) 	Sets BIOS Setup Utility access rights for user level.
Unattended Start (Note 1, Note 3, and Note 4)	<ul style="list-style-type: none"> • Disabled (default) • Enabled 	<i>Enabled</i> allows system to complete the boot process without a password. The keyboard remains locked until a password is entered. A password is required to boot from a diskette.

Notes:

1. This feature appears only if a user password has been set.
2. This feature appears only if a supervisor password has been set.
3. If both Legacy USB and Unattended Start are set to enabled in the BIOS setup menu, USB aware operating systems can unlock as PS/2 style keyboard and mouse without requiring the user to enter a password.
4. When Unattended Start is enabled in the BIOS setup menu, a USB aware operating system may override user password protection if used in conjunction with a USB keyboard and mouse without requiring the user to enter a password.

4.6 Power Menu

To access this menu, select Power from the menu bar at the top of the screen.

Maintenance	Main	Advanced	Security	Power	Boot	Exit
				ACPI		

The menu represented in Table 72 is for setting the power management features.

Table 72. Power Menu

Feature	Options	Description
ACPI	Select to display submenu	Sets the ACPI power management options.
After Power Failure	<ul style="list-style-type: none"> • Stay Off • Last State (default) • Power On 	<p>Specifies the mode of operation if an AC power loss occurs.</p> <p><i>Stay Off</i> keeps the power off until the power button is pressed.</p> <p><i>Last State</i> restores the previous power state before power loss occurred.</p> <p><i>Power On</i> restores power to the computer.</p>
Wake on PME	<ul style="list-style-type: none"> • Stay Off (default) • Power On 	Specifies how the computer responds to a PCI power management event.
Wake on Modem Ring	<ul style="list-style-type: none"> • Stay Off (default) • Power On 	Specifies how the computer responds to an incoming call on an installed modem when the power is off.

4.6.1 ACPI Submenu

To access this menu, select Power from the menu bar at the top of the screen and then ACPI.

Maintenance	Main	Advanced	Security	Power	Boot	Exit
				ACPI		

The submenu represented in Table 73 is for setting the ACPI power options.

Table 73. ACPI Submenu

Feature	Options	Description
ACPI Suspend State	<ul style="list-style-type: none"> • S1 State • S3 State (default) 	Specifies the ACPI sleep state.
Wake on LAN from S5	<ul style="list-style-type: none"> • Stay Off (default) • Power On 	In ACPI soft-off mode only, determines how the system responds to a LAN wake-up event.

4.7 Boot Menu

To access this menu, select Boot from the menu bar at the top of the screen.

Maintenance	Main	Advanced	Security	Power	Boot	Exit
						Boot Device Priority
						Hard Disk Drives
						Removable Devices
						ATAPI CD-ROM Drives

The menu represented in Table 74 is used to set the boot features and the boot sequence.

Table 74. Boot Menu

Feature	Options	Description
Quiet Boot	<ul style="list-style-type: none"> Disabled Enabled (default) 	<p><i>Disabled</i> displays normal POST messages.</p> <p><i>Enabled</i> displays OEM graphic instead of POST messages.</p>
Intel (R) Rapid BIOS Boot	<ul style="list-style-type: none"> Disabled Enabled (default) 	Enables the computer to boot without running certain POST tests.
Scan User Flash Area	<ul style="list-style-type: none"> Disabled (default) Enabled 	Enables the BIOS to scan the flash memory for user binary files that are executed at boot time.
USB Boot	<ul style="list-style-type: none"> Disabled Enabled (default) 	Enables the computer to boot from USB boot devices.
Boot Device Priority	Select to display submenu	Specifies the boot sequence from the available types of boot devices.
Hard Disk Drives	Select to display submenu	Specifies the boot sequence from the available hard disk drives.
Removable Devices	Select to display submenu	Specifies the boot sequence from the available removable devices.
ATAPI CD-ROM Drives	Select to display submenu	Specifies the boot sequence from the available ATAPI CD-ROM drives.

4.7.1 Boot Device Priority Submenu

To access this menu, select Boot on the menu bar and then Boot Devices Priority.

Maintenance	Main	Advanced	Security	Power	Boot	Exit
						Boot Device Priority
						Hard Disk Drives
						Removable Devices
						ATAPI CD-ROM Drives

The submenu represented in Table 75 is for setting boot devices priority.

Table 75. Boot Device Priority Submenu

Feature	Options	Description
1 st Boot Device 2 nd Boot Device 3 rd Boot Device 4 th Boot Device	<ul style="list-style-type: none"> • Removable Dev. • Hard Drive • ATAPI CD-ROM • Intel (R) Boot Agent (Note) • Disabled 	<p>Specifies the boot sequence according to the device type. The computer will attempt to boot from up to five devices as specified here. Only one of the devices can be an IDE hard disk drive. To specify boot sequence:</p> <ol style="list-style-type: none"> 1. Select the boot device with <↑> or <↓>. 2. Press <Enter> to set the selection as the intended boot device. <p>The default settings for the first through fourth boot devices are, respectively:</p> <ul style="list-style-type: none"> • Removable Dev. • Hard Drive • ATAPI CD-ROM • Intel Boot Agent

Note: The boot device identifier for Intel Boot Agent (IBA) may vary depending on the BIOS release.

4.7.2 Hard Disk Drives Submenu

To access this menu, select Boot on the menu bar and then Hard Disk Drives.

Maintenance	Main	Advanced	Security	Power	Boot	Exit
						Boot Device Priority
						Hard Disk Drives
						Removable Devices
						ATAPI CD-ROM Drives

The submenu represented in Table 76 is for setting hard disk drive priority.

Table 76. Hard Disk Drives Submenu

Feature	Options	Description
1 st Hard Disk Drive (Note)	Dependent on installed hard drives	Specifies the boot sequence from the available hard disk drives. To specify boot sequence: 1. Select the boot device with <↑> or <↓>. 2. Press <Enter> to set the selection as the intended boot device.

Note: This boot device submenu appears only if at least one boot device of this type is installed. This list will display up to twelve hard disk drives, the maximum number of hard disk drives supported by the BIOS.

4.7.3 Removable Devices Submenu

To access this menu, select Boot on the menu bar, then Removable Devices.

Maintenance	Main	Advanced	Security	Power	Boot	Exit
						Boot Device Priority
						Hard Disk Drives
						Removable Devices
						ATAPI CD-ROM Drives

The submenu represented in Table 77 is for setting removable device priority.

Table 77. Removable Devices Submenu

Feature	Options	Description
1 st Removable Device (Note)	Dependent on installed removable devices	Specifies the boot sequence from the available removable devices. To specify boot sequence: 1. Select the boot device with <↑> or <↓>. 2. Press <Enter> to set the selection as the intended boot device.

Note: This boot device submenu appears only if at least one boot device of this type is installed. This list will display up to four removable devices, the maximum number of removable devices supported by the BIOS.

4.7.4 ATAPI CD-ROM Drives Submenu

To access this menu, select Boot on the menu bar and then ATAPI CD-ROM Drives.

Maintenance	Main	Advanced	Security	Power	Boot	Exit
						Boot Device Priority
						Hard Disk Drives
						Removable Devices
						ATAPI CD-ROM Drives

The submenu represented in Table 78 is for setting ATAPI CD-ROM drive priority.

Table 78. ATAPI CD-ROM Drives Submenu

Feature	Options	Description
1 st ATAPI CDROM (Note)	Dependent on installed ATAPI CD-ROM drives	Specifies the boot sequence from the available ATAPI CD-ROM drives. To specify boot sequence: 1. Select the boot device with <↑> or <↓>. 2. Press <Enter> to set the selection as the intended boot device.

Note: This boot device submenu appears only if at least one boot device of this type is installed. This list will display up to four ATAPI CD-ROM drives, the maximum number of ATAPI CD-ROM drives supported by the BIOS.

4.8 Exit Menu

To access this menu, select Exit from the menu bar at the top of the screen.

Maintenance	Main	Advanced	Security	Power	Boot	Exit
-------------	------	----------	----------	-------	------	-------------

The menu represented in Table 79 is for exiting the BIOS Setup program, saving changes, and loading and saving defaults.

Table 79. Exit Menu

Feature	Description
Exit Saving Changes	Exits and saves the changes in CMOS SRAM.
Exit Discarding Changes	Exits without saving any changes made in the BIOS Setup program.
Load Setup Defaults	Loads the factory default values for all the Setup options.
Load Custom Defaults	Loads the custom defaults for Setup options.
Save Custom Defaults	Saves the current values as custom defaults. Normally, the BIOS reads the Setup values from flash memory. If this memory is corrupted, the BIOS reads the custom defaults. If no custom defaults are set, the BIOS reads the factory defaults.
Discard Changes	Discards changes without exiting Setup. The option values present when the computer was turned on are used.

5 Error Messages and Beep Codes

What This Chapter Contains

5.1	BIOS Error Messages.....	121
5.2	Port 80h POST Codes.....	123
5.3	Bus Initialization Checkpoints	127
5.4	Speaker	128
5.5	BIOS Beep Codes	128

5.1 BIOS Error Messages

Table 80 lists the error messages and provides a brief description of each.

Table 80. BIOS Error Messages

Error Message	Explanation
GA20 Error	An error occurred with Gate A20 when switching to protected mode during the memory test.
Pri Master HDD Error Pri Slave HDD Error Sec Master HDD Error Sec Slave HDD Error	Could not read sector from corresponding drive.
Pri Master Drive - ATAPI Incompatible Pri Slave Drive - ATAPI Incompatible Sec Master Drive - ATAPI Incompatible Sec Slave Drive - ATAPI Incompatible	Corresponding drive in not an ATAPI device. Run Setup to make sure device is selected correctly.
A: Drive Error	No response from diskette drive.
Cache Memory Bad	An error occurred when testing L2 cache. Cache memory may be bad.
CMOS Battery Low	The battery may be losing power. Replace the battery soon.
CMOS Display Type Wrong	The display type is different than what has been stored in CMOS. Check Setup to make sure type is correct.
CMOS Checksum Bad	The CMOS checksum is incorrect. CMOS memory may have been corrupted. Run Setup to reset values.
CMOS Settings Wrong	CMOS values are not the same as the last boot. These values have either been corrupted or the battery has failed.
CMOS Date/Time Not Set	The time and/or date values stored in CMOS are invalid. Run Setup to set correct values.
DMA Error	Error during read/write test of DMA controller.
FDC Failure	Error occurred trying to access diskette drive controller.
HDC Failure	Error occurred trying to access hard disk controller.

continued

Table 80. BIOS Error Messages (continued)

Error Message	Explanation
Checking NVRAM.....	NVRAM is being checked to see if it is valid.
Update OK!	NVRAM was invalid and has been updated.
Updated Failed	NVRAM was invalid but was unable to be updated.
Keyboard Error	Error in the keyboard connection. Make sure keyboard is connected properly.
KB/Interface Error	Keyboard interface test failed.
Memory Size Decreased	Memory size has decreased since the last boot. If no memory was removed then memory may be bad.
Memory Size Increased	Memory size has increased since the last boot. If no memory was added there may be a problem with the system.
Memory Size Changed	Memory size has changed since the last boot. If no memory was added or removed then memory may be bad.
No Boot Device Available	System did not find a device to boot.
Off Board Parity Error	A parity error occurred on an off-board card. This error is followed by an address.
On Board Parity Error	A parity error occurred in onboard memory. This error is followed by an address.
Parity Error	A parity error occurred in onboard memory at an unknown address.
NVRAM/CMOS/PASSWORD cleared by Jumper	NVRAM, CMOS, and passwords have been cleared. The system should be powered down and the jumper removed.
<CTRL_N> Pressed	CMOS is ignored and NVRAM is cleared. User must enter Setup.

5.2 Port 80h POST Codes

During the POST, the BIOS generates diagnostic progress codes (POST-codes) to I/O port 80h. If the POST fails, execution stops and the last POST code generated is left at port 80h. This code is useful for determining the point where an error occurred.

Displaying the POST-codes requires a PCI bus add-in card, often called a POST card. The POST card can decode the port and display the contents on a medium such as a seven-segment display.

NOTE

The POST card must be installed in PCI bus connector 1.

The tables below offer descriptions of the POST codes generated by the BIOS. Table 81 defines the uncompressed INIT code checkpoints, Table 82 describes the boot block recovery code checkpoints, and Table 83 lists the runtime code uncompressed in F000 shadow RAM. Some codes are repeated in the tables because that code applies to more than one operation.

Table 81. Uncompressed INIT Code Checkpoints

Code	Description of POST Operation
D0	NMI is Disabled. Onboard KBC, RTC enabled (if present). Init code Checksum verification starting.
D1	Keyboard controller BAT test, CPU ID saved, and going to 4 GB flat mode.
D3	Do necessary chipset initialization, start memory refresh, and do memory sizing.
D4	Verify base memory.
D5	Init code to be copied to segment 0 and control to be transferred to segment 0.
D6	Control is in segment 0. To check recovery mode and verify main BIOS checksum. If either it is recovery mode or main BIOS checksum is bad, go to check point E0 for recovery else go to check point D7 for giving control to main BIOS.
D7	Find Main BIOS module in ROM image.
D8	Uncompress the main BIOS module.
D9	Copy main BIOS image to F000 shadow RAM and give control to main BIOS in F000 shadow RAM.

Table 82. Boot Block Recovery Code Checkpoints

Code	Description of POST Operation
E0	Onboard Floppy Controller (if any) is initialized. Compressed recovery code is uncompressed in F000:0000 in Shadow RAM and give control to recovery code in F000 Shadow RAM. Initialize interrupt vector tables, initialize system timer, initialize DMA controller and interrupt controller.
E8	Initialize extra (Intel Recovery) Module.
E9	Initialize floppy drive.
EA	Try to boot from floppy. If reading of boot sector is successful, give control to boot sector code.
EB	Booting from floppy failed, look for ATAPI (LS-120, Zip) devices.
EC	Try to boot from ATAPI. If reading of boot sector is successful, give control to boot sector code.
EF	Booting from floppy and ATAPI device failed. Give two beeps. Retry the booting procedure again (go to check point E9).

Table 83. Runtime Code Uncompressed in F000 Shadow RAM

Code	Description of POST Operation
03	NMI is Disabled. To check soft reset/power-on.
05	BIOS stack set. Going to disable cache if any.
06	POST code to be uncompressed.
07	CPU init and CPU data area init to be done.
08	CMOS checksum calculation to be done next.
0B	Any initialization before keyboard BAT to be done next.
0C	KB controller I/B free. To issue the BAT command to keyboard controller.
0E	Any initialization after KB controller BAT to be done next.
0F	Keyboard command byte to be written.
10	Going to issue Pin-23,24 blocking/unblocking command.
11	Going to check pressing of <INS>, <END> key during power-on.
12	To init CMOS if "Init CMOS in every boot" is set or <END> key is pressed. Going to disable DMA and Interrupt controllers.
13	Video display is disabled and port-B is initialized. Chipset init about to begin.
14	8254 timer test about to start.
19	About to start memory refresh test.
1A	Memory Refresh line is toggling. Going to check 15 μ s ON/OFF time.
23	To read 8042 input port and disable Megakey GreenPC feature. Make BIOS code segment writeable.
24	To do any setup before Int vector init.
25	Interrupt vector initialization to begin. To clear password if necessary.
27	Any initialization before setting video mode to be done.
28	Going for monochrome mode and color mode setting.
2A	Different buses init (system, static, output devices) to start if present. (See Section 5.3 for details of different buses.)
2B	To give control for any setup required before optional video ROM check.
2C	To look for optional video ROM and give control.
2D	To give control to do any processing after video ROM returns control.
2E	If EGA/VGA not found then do display memory R/W test.
2F	EGA/VGA not found. Display memory R/W test about to begin.
30	Display memory R/W test passed. About to look for the retrace checking.
31	Display memory R/W test or retrace checking failed. To do alternate Display memory R/W test.
32	Alternate Display memory R/W test passed. To look for the alternate display retrace checking.
34	Video display checking over. Display mode to be set next.
37	Display mode set. Going to display the power-on message.
38	Different buses init (input, IPL, general devices) to start if present. (See Section 5.3 for details of different buses.)
39	Display different buses initialization error messages. (See Section 5.3 for details of different buses.)
3A	New cursor position read and saved. To display the Hit message.

continued

Table 83. Runtime Code Uncompressed in F000 Shadow RAM (continued)

Code	Description of POST Operation
40	To prepare the descriptor tables.
42	To enter in virtual mode for memory test.
43	To enable interrupts for diagnostics mode.
44	To initialize data to check memory wrap around at 0:0.
45	Data initialized. Going to check for memory wrap around at 0:0 and finding the total system memory size.
46	Memory wrap around test done. Memory size calculation over. About to go for writing patterns to test memory.
47	Pattern to be tested written in extended memory. Going to write patterns in base 640k memory.
48	Patterns written in base memory. Going to find out amount of memory below 1M memory.
49	Amount of memory below 1M found and verified. Going to find out amount of memory above 1M memory.
4B	Amount of memory above 1M found and verified. Check for soft reset and going to clear memory below 1M for soft reset. (If power on, go to check point # 4Eh).
4C	Memory below 1M cleared. (SOFT RESET) Going to clear memory above 1M.
4D	Memory above 1M cleared. (SOFT RESET) Going to save the memory size. (Go to check point # 52h).
4E	Memory test started. (NOT SOFT RESET) About to display the first 64k memory size.
4F	Memory size display started. This will be updated during memory test. Going for sequential and random memory test.
50	Memory testing/initialization below 1M complete. Going to adjust displayed memory size for relocation/shadow.
51	Memory size display adjusted due to relocation/ shadow. Memory test above 1M to follow.
52	Memory testing/initialization above 1M complete. Going to save memory size information.
53	Memory size information is saved. CPU registers are saved. Going to enter in real mode.
54	Shutdown successful, CPU in real mode. Going to disable gate A20 line and disable parity/NMI.
57	A20 address line, parity/NMI disable successful. Going to adjust memory size depending on relocation/shadow.
58	Memory size adjusted for relocation/shadow. Going to clear Hit message.
59	Hit message cleared. <WAIT...> message displayed. About to start DMA and interrupt controller test.
60	DMA page register test passed. To do DMA#1 base register test.
62	DMA#1 base register test passed. To do DMA#2 base register test.
65	DMA#2 base register test passed. To program DMA unit 1 and 2.
66	DMA unit 1 and 2 programming over. To initialize 8259 interrupt controller.
7F	Extended NMI sources enabling is in progress.
80	Keyboard test started. Clearing output buffer, checking for stuck key, to issue keyboard reset command.
81	Keyboard reset error/stuck key found. To issue keyboard controller interface test command.
82	Keyboard controller interface test over. To write command byte and init circular buffer.
83	Command byte written, global data init done. To check for lock-key.

continued

Table 83. Runtime Code Uncompressed in F000 Shadow RAM (continued)

Code	Description of POST Operation
84	Lock-key checking over. To check for memory size mismatch with CMOS.
85	Memory size check done. To display soft error and check for password or bypass setup.
86	Password checked. About to do programming before setup.
87	Programming before setup complete. To uncompress SETUP code and execute CMOS setup.
88	Returned from CMOS setup program and screen is cleared. About to do programming after setup.
89	Programming after setup complete. Going to display power-on screen message.
8B	First screen message displayed. <WAIT...> message displayed. PS/2 Mouse check and extended BIOS data area allocation to be done.
8C	Setup options programming after CMOS setup about to start.
8D	Going for hard disk controller reset.
8F	Hard disk controller reset done. Floppy setup to be done next.
91	Floppy setup complete. Hard disk setup to be done next.
95	Init of different buses optional ROMs from C800 to start. (See Section 5.3 for details of different buses.)
96	Going to do any init before C800 optional ROM control.
97	Any init before C800 optional ROM control is over. Optional ROM check and control will be done next.
98	Optional ROM control is done. About to give control to do any required processing after optional ROM returns control and enable external cache.
99	Any initialization required after optional ROM test over. Going to setup timer data area and printer base address.
9A	Return after setting timer and printer base address. Going to set the RS-232 base address.
9B	Returned after RS-232 base address. Going to do any initialization before Coprocessor test.
9C	Required initialization before Coprocessor is over. Going to initialize the Coprocessor next.
9D	Coprocessor initialized. Going to do any initialization after Coprocessor test.
9E	Initialization after Coprocessor test is complete. Going to check extended keyboard, keyboard ID and num-lock.
A2	Going to display any soft errors.
A3	Soft error display complete. Going to set keyboard typematic rate.
A4	Keyboard typematic rate set. To program memory wait states.
A5	Going to enable parity/NMI.
A7	NMI and parity enabled. Going to do any initialization required before giving control to optional ROM at E000.
A8	Initialization before E000 ROM control over. E000 ROM to get control next.
A9	Returned from E000 ROM control. Going to do any initialization required after E000 optional ROM control.
AA	Initialization after E000 optional ROM control is over. Going to display the system configuration.
AB	Put INT13 module runtime image to shadow.
AC	Generate MP for multiprocessor support (if present).
AD	Put CGA INT10 module (if present) in Shadow.

continued

Table 83. Runtime Code Uncompressed in F000 Shadow RAM (continued)

Code	Description of POST Operation
AE	Uncompress SMBIOS module and init SMBIOS code and form the runtime SMBIOS image in shadow.
B1	Going to copy any code to specific area.
00	Copying of code to specific area done. Going to give control to INT-19 boot loader.

5.3 Bus Initialization Checkpoints

The system BIOS gives control to the different buses at several checkpoints to do various tasks. Table 84 describes the bus initialization checkpoints.

Table 84. Bus Initialization Checkpoints

Checkpoint	Description
2A	Different buses init (system, static, and output devices) to start if present.
38	Different buses init (input, IPL, and general devices) to start if present.
39	Display different buses initialization error messages.
95	Init of different buses optional ROMs from C800 to start.

While control is inside the different bus routines, additional checkpoints are output to port 80h as WORD to identify the routines under execution. In these WORD checkpoints, the low byte of the checkpoint is the system BIOS checkpoint from which the control is passed to the different bus routines. The high byte of the checkpoint is the indication of which routine is being executed in the different buses. Table 85 describes the upper nibble of the high byte and indicates the function that is being executed.

Table 85. Upper Nibble High Byte Functions

Value	Description
0	func#0, disable all devices on the bus concerned.
1	func#1, static devices init on the bus concerned.
2	func#2, output device init on the bus concerned.
3	func#3, input device init on the bus concerned.
4	func#4, IPL device init on the bus concerned.
5	func#5, general device init on the bus concerned.
6	func#6, error reporting for the bus concerned.
7	func#7, add-on ROM init for all buses.

Table 86 describes the lower nibble of the high byte and indicates the bus on which the routines are being executed.

Table 86. Lower Nibble High Byte Functions

Value	Description
0	Generic DIM (Device Initialization Manager)
1	On-board System devices
2	ISA devices
3	EISA devices
4	ISA PnP devices
5	PCI devices

5.4 Speaker

A 47 Ω inductive speaker is mounted on the D845BG and the D845PT board. The speaker provides audible error code (beep code) information during POST.

For information about	Refer to
The location of the onboard speaker on the D845BG board	Figure 1, page 14
The location of the onboard speaker on the D845PT board	Figure 2, page 15

5.5 BIOS Beep Codes

Whenever a recoverable error occurs during POST, the BIOS displays an error message describing the problem (see Table 87). The BIOS also issues a beep code (one long tone followed by two short tones) during POST if the video configuration fails (a faulty video card or no card installed) or if an external ROM module does not properly checksum to zero.

An external ROM module (for example, a video BIOS) can also issue audible errors, usually consisting of one long tone followed by a series of short tones. For more information on the beep codes issued, check the documentation for that external device.

There are several POST routines that issue a POST terminal error and shut down the system if they fail. Before shutting down the system, the terminal-error handler issues a beep code signifying the test point error, writes the error to I/O port 80h, attempts to initialize the video and writes the error in the upper left corner of the screen (using both monochrome and color adapters).

If POST completes normally, the BIOS issues one short beep before passing control to the operating system.

Table 87. Beep Codes

Beep	Description
1	Refresh failure
2	Parity cannot be reset
3	First 64 KB memory failure
4	Timer not operational
5	Not used
6	8042 GateA20 cannot be toggled
7	Exception interrupt error
8	Display memory R/W error
9	Not used
10	CMOS Shutdown register test error
11	Invalid BIOS (e.g. POST module not found, etc.)

