

# 127×38mm

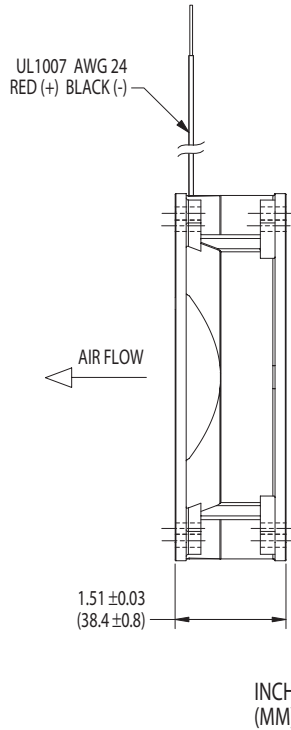
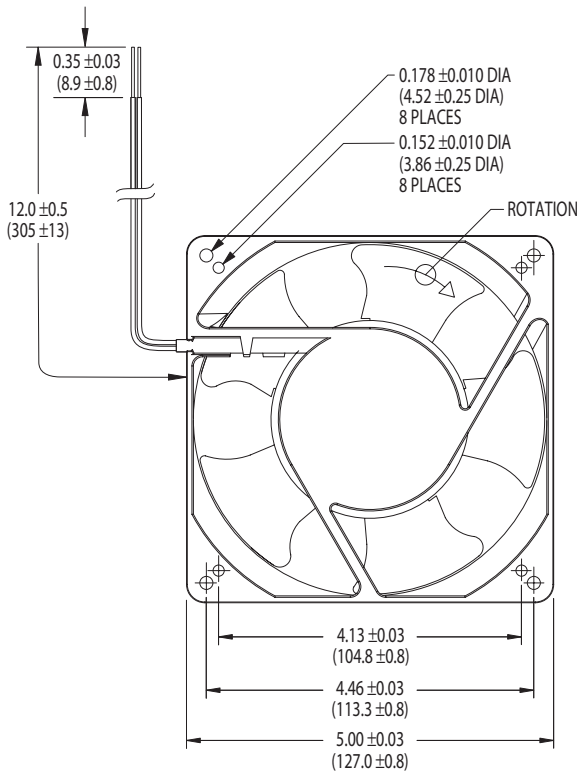

- ▶ 12V, 24V and 48V Models
- ▶ Polarity Protected
- ▶ Permanently Lubricated Ball Bearings
- ▶ Alarm/Tachometer/Thermal Speed Control/PWM Speed Control Options
- ▶ Built-in Interactive Control Available
- ▶ Die-Cast Metal Housing
- ▶ One-Piece, Black Thermoplastic Impeller Rated V-0
- ▶ Color-Coded 12-inch (305 mm) Leads

Unit weight = 13.8 oz. (391 g)

## TA500DC Series—Electrical and Mechanical Characteristics

Model	Air Flow (CFM)	Operating Voltage		Current (mA)	Power (W)	Sound Level			Fan Speed (rpm)	Bearing	Operating Temp.		L10 Life † (hours)
		Nom. (V)	Range (V)			Pressure (dBA)	NPEL (Bels)	Min. (°C)			Max. (°C)		
A34367	120	12	7.0-14	600	7.2	43.1	5.8	2,750	Ball	-10	+70	62,600	
A34376	120	24	12-28	300	7.2	43.1	5.8	2,750	Ball	-10	+70	62,600	
A34377	120	48	24-56	150	7.2	43.1	5.8	2,750	Ball	-10	+70	62,600	
A34374	130	12	7.0-14	700	8.4	48.8	6.1	3,000	Ball	-10	+70	59,800	
A34364	130	24	12-28	350	8.4	48.8	6.1	3,000	Ball	-10	+70	59,800	
A34375	130	48	24-56	175	8.4	48.8	6.1	3,000	Ball	-10	+70	59,800	
A34365	140	12	7.0-14	850	10.2	51.7	6.2	3,200	Ball	-10	+70	57,000	
A34359	150	12	7.0-14	980	11.8	52.5	6.6	3,450	Ball	-10	+70	55,000	
A34361	150	24	12-28	500	12.0	52.5	6.6	3,450	Ball	-10	+70	55,000	
A34362	150	48	24-56	280	13.4	52.5	6.6	3,450	Ball	-10	+70	55,000	

Note: Air flow, current, power, speed and sound level ratings are at nominal voltage against zero static pressure. NPEL = Noise Power Emission Level. Power termination, control and signal options are designated by two-digit suffixes added to the model names: For color-coded 12-inch power leads with stripped ends, add "-16" to the model numbers.

† L10 bearing life expectancy at  $T_A = +40^\circ\text{C}$ , nominal voltage. Failure criteria for life testing that establishes this figure include a 15% reduction in speed or a 5 dBA increase in sound pressure.

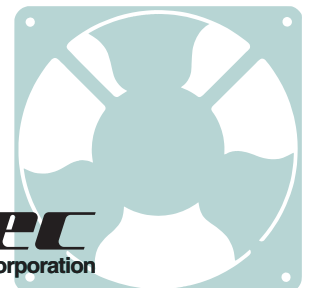

# 127×38mm

## TA500DC Air Performance Characteristics

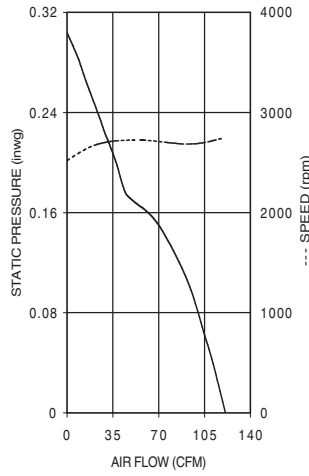

A34367

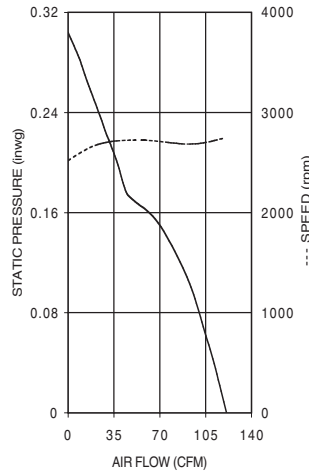

A34376

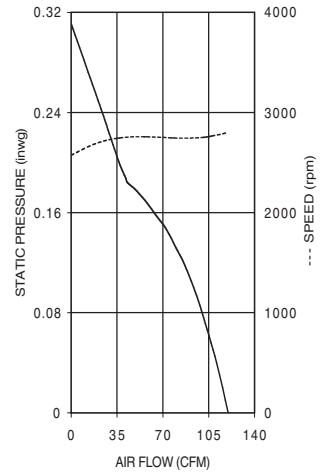

A34377

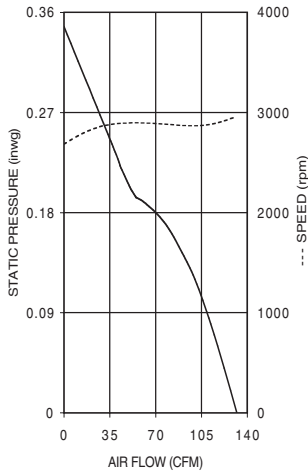

A34374

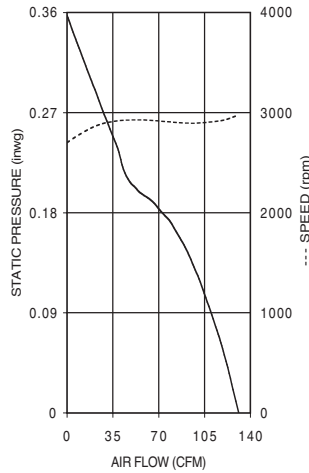

A34364

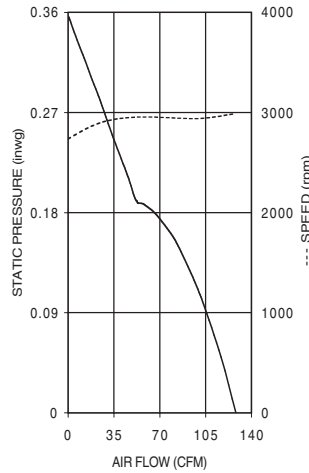

A34375

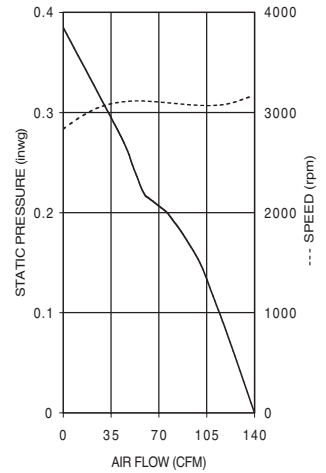

A34365

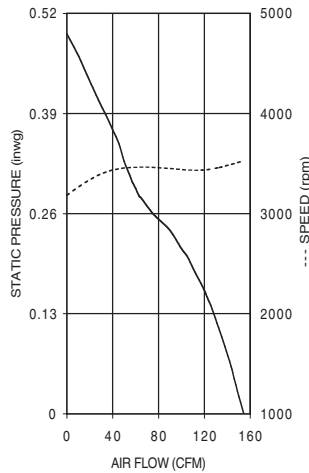

A34359

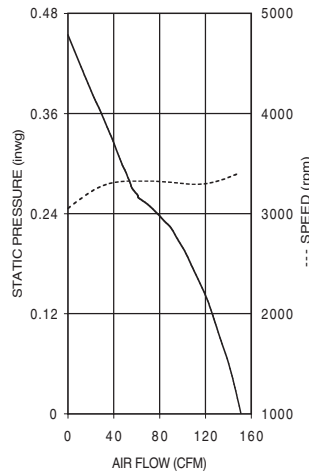

A34361

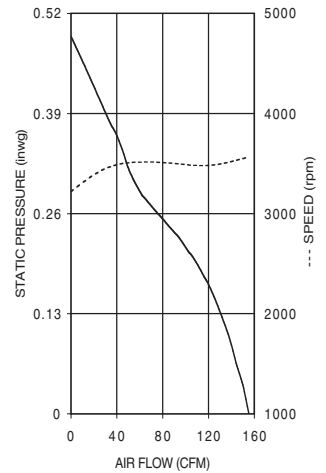

A34362

