

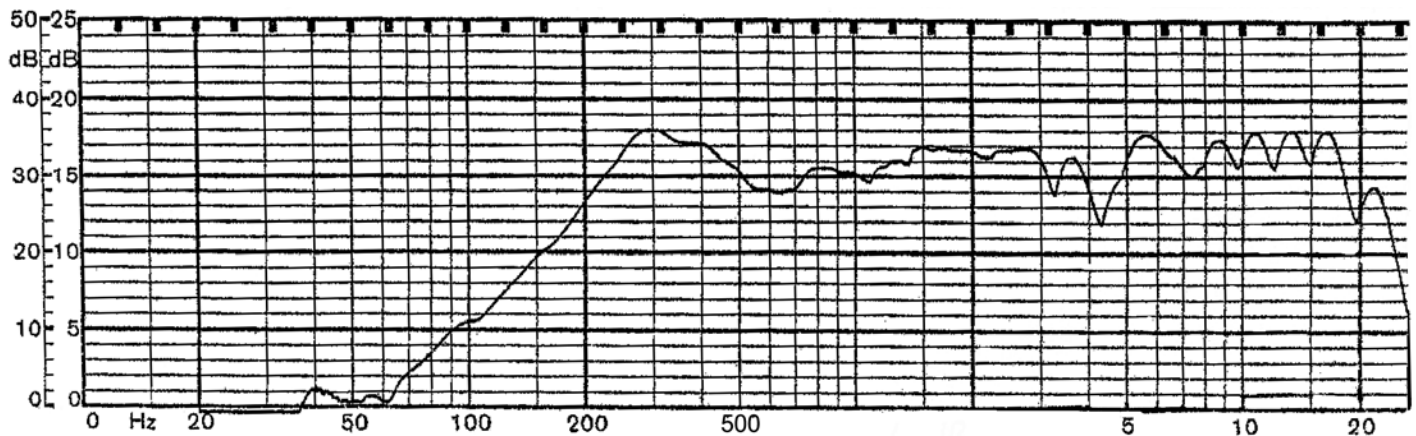

Specifications

Nominal Size	66 mm (2.50 in)	(See attached drawing)
Impedance	8 Ohm \pm 15%	at 800 Hz 1 V
Resonant frequency	300 Hz \pm 60 Hz	at 1 V
Sound pressure level	90 dB/w \pm 3 dB	1 w 50 cm ave. at 0.5K, 0.8K, 1.0K, 1.2K Hz
Response	Fo Hz ~ 20 KHz max 10 dB	
Input power	Nominal 3 W	Handling capacity 5 W
Operation	must be normal at program source 3 W	
Buzz, rattle, etc.	must be normal at sine wave 4.89 V	
Magnet	Size: 45 x 22 x 8 mm	
Load test	White noise 3 W	for 48 hours
Heat test	70 \pm 2° C	20-50% R.H. 48 hours
Humidity test	40 \pm 2° C	90-95% R.H. 48 hours

Frequency Response Curve

Potentiometer range	50 dB
Rectifier	RMS
Lower limit frequency	20 Hz
Wr. speed	100 mm/sec



Zero level 60 dB

REV.	DESCRIPTION	DATE
A	NEW DRAWING	8/8/2006

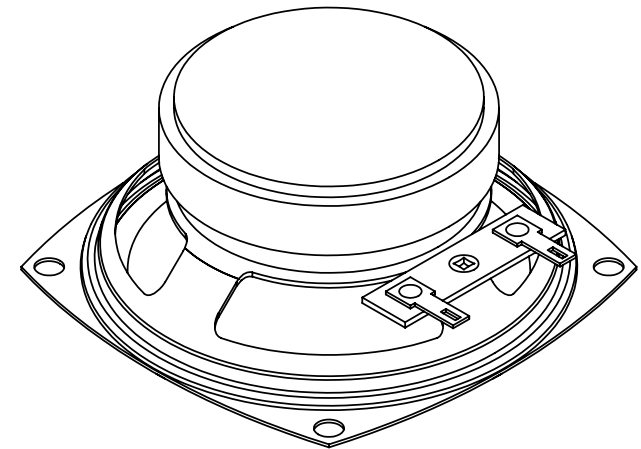
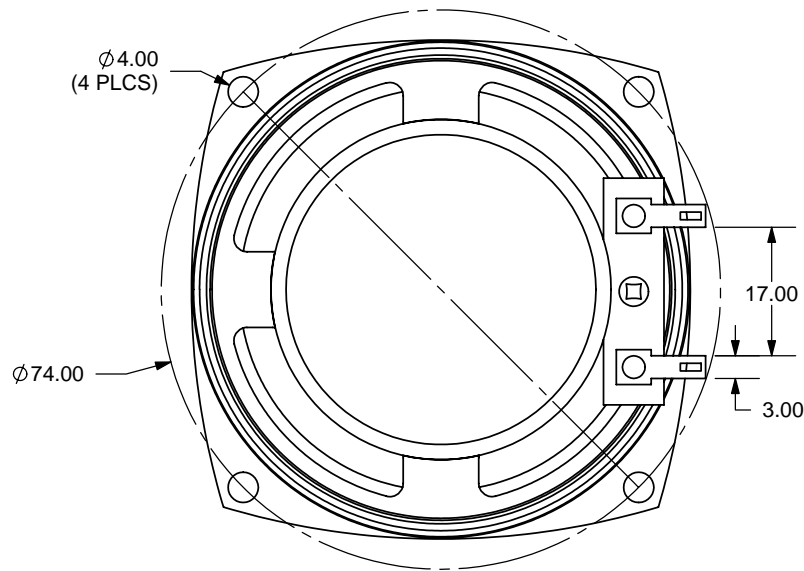
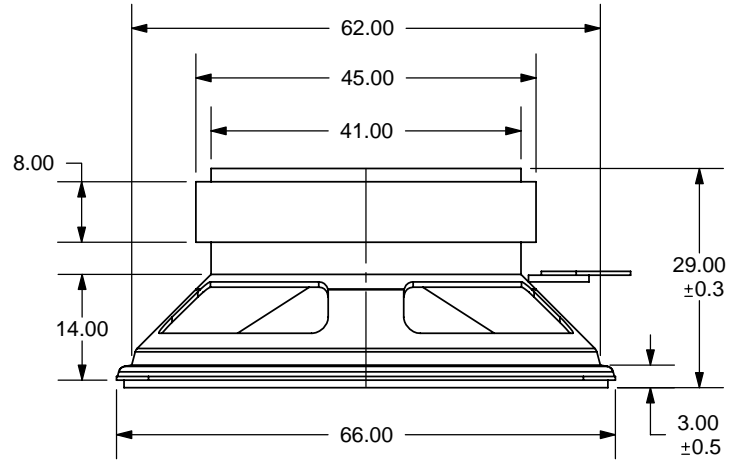

TOLERANCE:
 $\pm 0.5\text{mm}$ UNLESS OTHERWISE
 SPECIFIED



20050 SW 112th Ave.
 Tualatin, OR 97062
 Phone: 503-643-4899
 800-275-4899
 Fax: 503-372-1266
 Website: www.cui.com

TITLE: Square frame paper cone - ferrite magnet		REV: A
PART NO. GF0668	UNITS: MM [INCHES]	
DRAWN BY: ZRJ	APPROVED BY:	SCALE: 1:1

PC FILE NAME:
 GF0668

COPYRIGHT 2006 BY CUI INC.