

Spool valves intended for use in potentially explosive atmospheres caused by gases, vapours, mists and/or dusts (ATEX directive 94/9/EC)



ISO 5599/1 spool valve size 1
solenoid air operated



ISO 5599/1 spool valve size 2
solenoid air operated



ISO 5599/1 spool valve size 3
solenoid air operated

MULTIFUNCTION

Multifunction valves are equipped with 2 pilot selector seals on the top face on both the pilot and the return sides. Each selector seal can be set on 2 positions, allowing internal or external supply to the pilot or return operators in both the air and solenoid air operated versions. External supply allows the valves to operate with a supply pressure ranging from 0 to 12 bar and under vacuum pressure. Each seal includes a tag with an arrow to be set into the notch corresponding to the required pilot function (see below). Modifications of the function are very simple. The valves are delivered pre-set according to the valve code selected on your order.

Air operated spool valve

Solenoid air operated spool valve

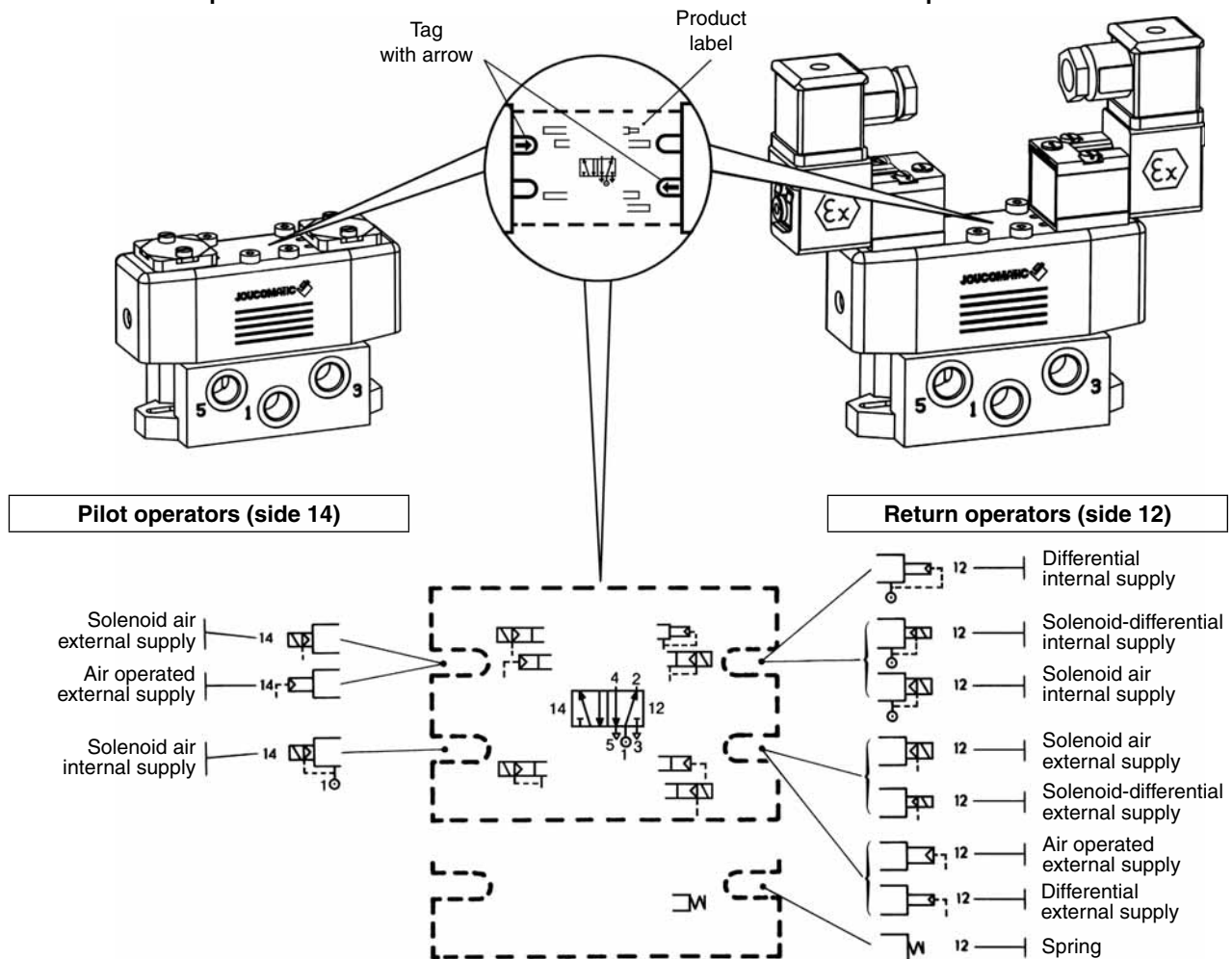

The table below shows the accessories (delivered with the valves) and/or the solenoid valves appropriate for each function. These components can be supplied separately to change the function of the valve.

	function		pilot		return		
	symbols	pilot (14) return (12)					
5/2		Air operated Spring return		●			●
		Air operated Differential return		●	●		
		Air operated Air return		●	●		
		Solenoid air operated Spring return	●				●
		Solenoid air operated Differential return	●		●		
		Solenoid air operated Air return	●		●		
		Solenoid air operated Solenoid-differential return	●			●	
		Solenoid air operated pilot and return	●			●	
5/3		W1-W2-W3 Air operated		●	●		
		W1-W2-W3 Solenoid air operated	●			●	
			Solenoid valves 189-190-195-374	Interface 88100074	Interface 88100074	Solenoid valves 189-190-195-374	Blanking plate 88100073

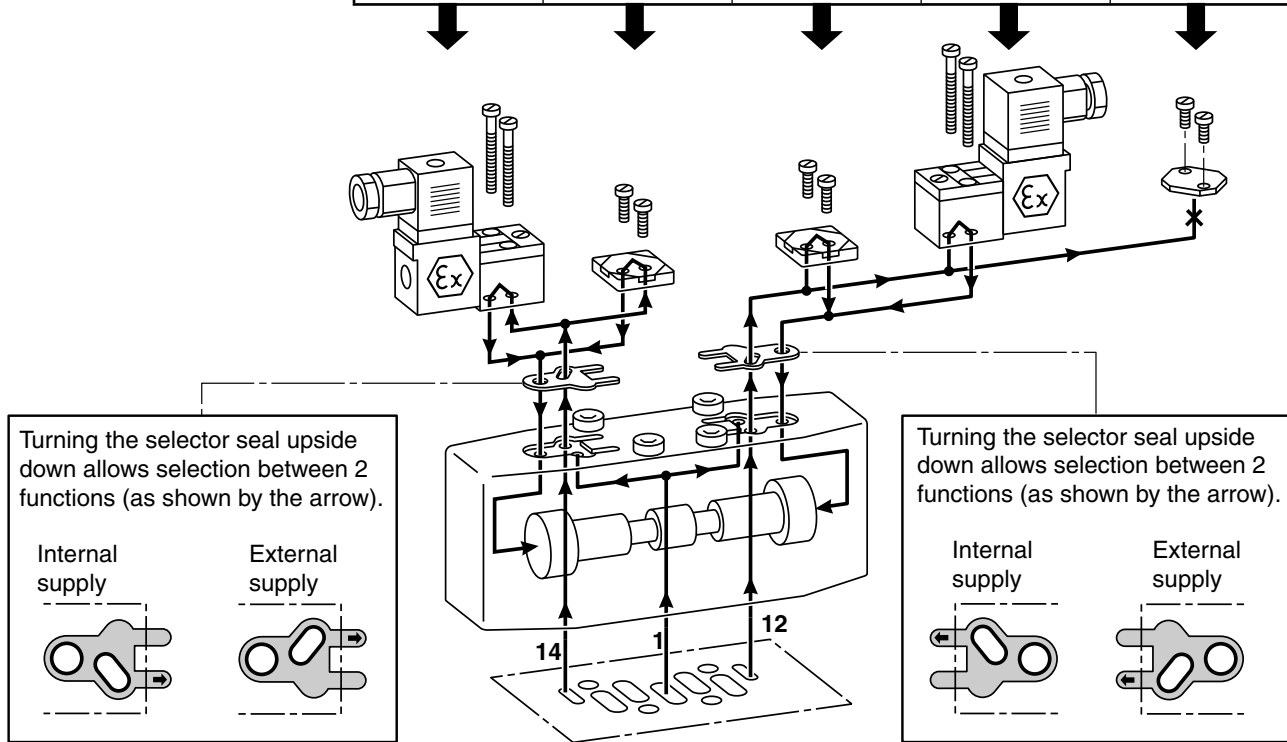

00500GB-2008/R01 Availability, design and specifications are subject to change without notice. All rights reserved.

USE WITH NON-LUBRICATED AIR

The ISO-compliant valves will operate satisfactorily with lubricated, non-lubricated or dry air due to their patented, T-shaped oscillating sealing element backed with a cushioning seal. This sealing assembly maintains a minimum pilot pressure which remains constant even if the valve is switched off for a longer period of time. On restart, the valve's performance will be the same as under continuous operating conditions. This characteristic ensures safer operation both on valve start-up and during operation.

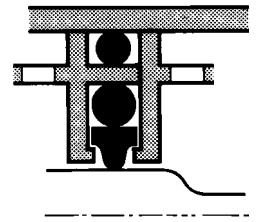

MANUAL TESTERS INDICATING THE POSITION OF THE SPOOL (OPTION)

On request, the spool valves can be delivered with manual testers to check the position of the spool or move it by manual override.

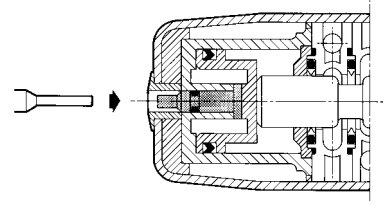

EASY INSTALLATION

ASCO/JOUCOMATIC offers a complementary range of components which simplify the installation of the ISO-compliant valves:

- Single subbases with side or bottom ports (1) - see pages 7 and 9
- Joinable subbases with bottom ports - see pages 8 and 9

Various accessories complete the range - see page 14



(1)

JOUCOMATIC

MULTIFUNCTION SPOOL VALVE

solenoid air operated
 subbase mounted body
 according to ISO 5599/1



ATEX

5/2-5/3

Series

541-542-543

Type

ISO sizes 1-2-3

GENERAL

- Spool valves intended for use in potentially explosive atmospheres caused by gases, vapours, mists and/or dusts (**ATEX directive 94/9/EC**).

CLASSIFICATION

ISO 1-2-3 : Ⓜ II 2 GD c Ta 60°C T85°C (T6) (zones 1-21)

ISO 1-3 : Ⓜ II 3 GD c Ta 60°C T85°C (T6) (zones 2-22)

Compliance with the Essential Health and Safety Requirements has been assured by compliance with European Standards **EN 13463-1** and **prEN 13463-5**.

SPECIFICATIONS

Fluid
Operating pressure

	ISO 1	ISO 2	ISO 3
Fluid	Air or neutral gas, filtered, lubricated or not		
Operating pressure	- 0,950 to +12 bar (with external supply to pilot)		
	+3 to +10 bar (with internal supply to pilot)		
	Can be used with vacuum - 0,950 bar max.		
Pilot pressure	See CHOICE OF EQUIPMENT		
Ambient temperature	- 10°C to +60°C		
Flow (Qv at 6 bar)	1400 l/min (ANR)	2800 l/min (ANR)	4200 l/min (ANR)
Flow coefficients			
- conforming to ISO 6358			
sonic conductance	C = 5,8 x 10 ⁻⁸ m ³ /s.Pa	C = 1,136 x 10 ⁻⁷ m ³ /s.Pa	C = 16 x 10 ⁻⁸ m ³ /s.Pa
absolute static pressure	b = 0,28	b = 0,22	b = 0,34
- conforming to NF E29312			
(l/min)	Kv = 20	Kv = 37,5	Kv = 60
Life	30 million cycles		15 million cycles
Base	ISO 5599/1 sizes 1-2-3 - AFNOR NF E49080		
Subbases	Single subbases ISO/AFNOR NF E49085		
	Joinable subbases ISO/VDMA 24345		

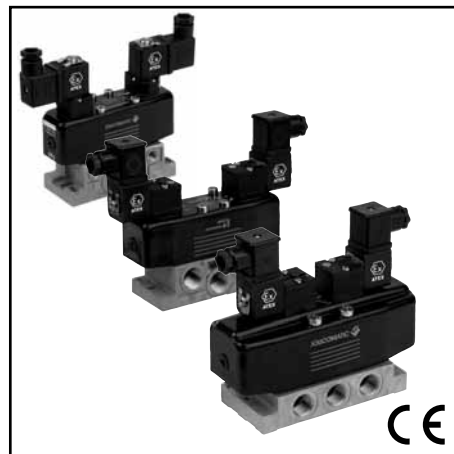

CONSTRUCTION

Cover Painted steel
Pilot and return assembly POM (acetal resin)
Seals NBR (nitrile) and PUR (polyurethane)
Internal parts POM (acetal resin), light alloy

ELECTRICAL CHARACTERISTICS

pilot series	coil size	classification	voltage		consumption		insulation class	protection degree	electrical connection
			~	=	inrush	holding			
189	PV-m22	II2 GD EEx m II T5..T4	~	24V-115V-230V/50Hz	9 VA	5 VA (4 W)	F	IP 65	moulded-in supply cable, rotatable on 360°
			=	24V		4 W			
189	size 22 DU	II3 D IP65 T85°C à T100°C	~	24V-115V-230V/50 Hz	6 VA	3,5 VA (2,5 W)	F	IP 65	spade plug size 22 connector, DIN 43650, 11 mm, industry standard B, rotatable by 180°
			=	24V-48V		3 W			
190	size 25 DU	II3 D IP65 T85°C à T100°C	~	24V-48V-115V-230V/50 Hz	9 VA	4 VA (3 W)	F	IP 65	spade plug size 30 connector, ISO4400/EN175301-803, form A, rotatable by 90°
			=	12V-24V-48V-110V		3 W			
192*	size 30 DU	II3 D IP65 T85°C à T135°C	~	24V-115V-230V/50 Hz	12 VA	6 VA (4 W)	F	IP 65	spade plug size 30 connector, ISO4400/EN175301-803, form A, rotatable by 90°
			=	24V		5 W			
374	size 22 DU	II2 GD EEx d IIB + H2 T6..T4	~	24V-115V-230V/50 Hz	55 VA	23 VA (10,5W)	F	IP 65	Screw terminal coil, explosionproof cable gland on request
			=	24V		11,2 W			
195	size 30	II2 G EEx ia IIC T6	=	24V		1,6 W	F	IP 65	spade plug size 30 connector, ISO4400/EN175301-803, form A, rotatable by 90°

Solenoid valve 190 is dual voltage (24V~, 12V=) (48V~, 24V=) (115V~, 48V=) (230V~, 110V=)

* Solenoid valve 192 for ISO 3 only

COIL TEMPERATURE CLASSIFICATION TABLES

Solenoid operators for potentially explosive atmospheres

AC (~) coils, zones 1-21 / 2-22

DC (=) coils, zones 1-21 / 2-22

DC (=) coils, zones 1 - 2

Pn (Watt)	pilot/coil		max. ambient °C ¹⁾ surface temperature			
	189 PV m22	374 NK	T6 85°C	T5 100°C	T4 135°C	T3 200°C
	Insulation class F (155°C) 100 % E.D.					
4	•				60	
10,5		•			60	

Pn (Watt)	pilot/coil		max. ambient °C ¹⁾ surface temperature			
	189 PV m22	374 NK	T6 85°C	T5 100°C	T4 135°C	T3 200°C
	Insulation class F (155°C) 100 % E.D.					
4	•			25	80	
11,2		•	25	40	60	

Pn (Watt)	pilot/coil	max. ambient °C ¹⁾ surface temperature			
		T6 85°C	T5 100°C	T4 135°C	T3 200°C
	Insulation class F (155°C) 100 % E.D.				
1,6	•	50			

1) Minimum ambient temperature: -10°C

AC (~) coils, zone 22

Pn (Watt)	pilot/coil			max. ambient °C ¹⁾ surface temperature			
	189 size 22	190 size 25	192(*) size 30	85°C	100°C	135°C	200°C
Insulation class F (155°C) 100 % E.D.							
2,5	●			40	60		
3		●		40	60		
4 (*)			●	25	60		

DC (=) coils, zone 22

Pn (Watt)	pilot/coil			max. ambient °C ¹⁾ surface temperature			
	189 size 22	190 size 25	192(*) size 30	85°C	100°C	135°C	200°C
Insulation class F (155°C) 100 % E.D.							
2,5	●			40	60		
3		●		40	60		
5 (*)			●	25	40	60	

1) Minimum ambient temperature: -10°C

(*) ISO 3 only

CHOICE OF EQUIPMENT

When ordering, please specify: the standard spool valve code and its **ATEX option** and the **solenoid pilot code**

5/2 symbols	function solenoid air pilot (14) return (12)	size	response time (ms)		pilot pressure (bar)		spool valve	2 codes		(M)
			ener-gized	de-ener-gized	min.	max.		+	solenoid pilot quantity and code with standard connector	
	spring return	ISO 1	25	66	3	10	54191023	+ 1x	PV 18900001 DU 18900001 DU 19000005 DU 19000006 DU 19000017 DU 19200001* DU 19200002* DU 19200003* 19500017 NKS374A090 NKS374A090 MS	●
		ISO 2	19	68	2,5					●
		ISO 3	45	130	3					×
	differential return	ISO 1	41	45	3	10	54191024	+ 1x	PV 18900001 DU 18900001 DU 19000005 DU 19000006 DU 19000017 DU 19200001* DU 19200002* DU 19200003* 19500017 NKS374A090 NKS374A090 MS	●
		ISO 2	32	49	2					●
		ISO 3	71	82	3					×
	air return	ISO 1	21	-	1,5	10	54191025	+ 2x	PV 18900001 DU 18900001 DU 19000005 DU 19000006 DU 19000017 DU 19200001* DU 19200002* DU 19200003* 19500017 NKS374A090 NKS374A090 MS	▼
		ISO 2	16	-	1,5					×
		ISO 3	28	-	1,5					●
	solenoid-differential return	ISO 1	16	18	3	10	54191026	+ 2x	PV 18900001 DU 18900001 DU 19000005 DU 19000006 DU 19000017 DU 19200001* DU 19200002* DU 19200003* 19500017 NKS374A090 NKS374A090 MS	●/▼
		ISO 2	15	16	2					×
		ISO 3	21	23	3					●
	solenoid air return	ISO 1	17	16	1,5	10	54191027	+ 2x	PV 18900001 DU 18900001 DU 19000005 DU 19000006 DU 19000017 DU 19200001* DU 19200002* DU 19200003* 19500017 NKS374A090 NKS374A090 MS	×
		ISO 2	16	15	1,5					●
		ISO 3	26	25	1,5					●

5/3 symbols	function pilot (14) solenoid air return (12)	size	response time (ms)		pilot pressure (bar)		spool valve	2 codes		(M)
			ener-gized	de-ener-gized	min.	max.		+	solenoid pilot quantity and code with standard connector	
	Pressure held W1	ISO 1	16	17	3	10	54191028	+ 2x	PV 18900001 DU 18900001 DU 19000005 DU 19000006 DU 19000017 DU 19200001* DU 19200002* DU 19200003* 19500017 NKS374A090 NKS374A090 MS	●
		ISO 2	16	16						●
		ISO 3	27	26						×
	Pressure applied W2	ISO 1	44	18	3	10	54191030	+ 2x	PV 18900001 DU 18900001 DU 19000005 DU 19000006 DU 19000017 DU 19200001* DU 19200002* DU 19200003* 19500017 NKS374A090 NKS374A090 MS	●
		ISO 2	54	18						▼
		ISO 3	93	27						×
	Pressure release W3	ISO 1	17	47	3	10	54191029	+ 2x	PV 18900001 DU 18900001 DU 19000005 DU 19000006 DU 19000017 DU 19200001* DU 19200002* DU 19200003* 19500017 NKS374A090 NKS374A090 MS	●/▼
		ISO 2	19	61						×
		ISO 3	29	28						●

(M) Type of manual override on pilot(s) : X : without ● : screwdriver ▼ : impulse ●/▼ : impulse or lock (push-turn type)

* Solenoid valve 192 for ISO 3 only



OPTIONS

- Equipment with manual testers so that the spool position can be checked
- Equipment for use in potentially **explosive atmospheres** caused by dusts or gases (ATEX Directive 94/9/EC)

zones	classification	ATEX option catalogue number		
		ISO 1	ISO 2	ISO 3
2-22	II3GD c T 60°C T 85°C (T6)	612027	-	612029
1-21	II2GD c IIC T 60°C T85°C (T6)	612030	612090	612032

00500GB-2008/R02 Availability, design and specifications are subject to change without notice. All rights reserved.

SUBBASES

description		ports				size	code		
type of subbase	type of connection	12-14	1	2-4	3-5				
single subbase ISO 5599/1 AFNOR NFE 49080	side 	tapped	G 1/8	G 1/4	G 1/4	G 1/4	ISO 1	35500076	
			G 1/8	G 1/4	G 1/4	G 3/8		35500061	
			G 1/8	G 3/8	G 3/8	G 3/8		35500382	
			G 1/8	G 3/8	G 3/8	G 3/8	ISO 2	35500560	
			G 1/8	G 1/2	G 1/2	G 1/2		35500562	
			G 1/8	G 1/2	G 1/2	G 1/2	ISO 3	35500171	
	G 1/8	G 3/4	G 3/4	G 3/4	35500192				
	bottom 	tapped	G 1/8	G 1/4	G 1/4	G 1/4	ISO 1	35500077	
			G 1/2	G 3/8	G 3/8	G 3/8	ISO 2	35500085	
		with couplers	Ø 4 mm	for 8 mm O.D.		G 1/4	ISO 1	35500069	
joinable subbase ISO 5599/1 VDMA 24345	bottom 	subbase	G 1/8	-	G 1/4	-	ISO 1	35500165	
		set of 2 end plates	-	G 3/8	-	G 3/8		35500166	
		subbase	G 1/8	-	G 3/8	-	ISO 2	35500169	
		set of 2 end plates	-	G 1/2	-	G 1/2		35500170	
		subbase	G 1/8	-	G 1/2	-	ISO 3	35500173	
		set of 2 end plates	-	G 1	-	G 1		35500174	
		set of 3 plugs on main pressure (1) and exhausts (3-5) for 2 different pressure supplies (see A)						ISO 1	88135521
								ISO 2	88135522
						ISO 3	88135520		

Set of 2 end plates supplied with 3 plugs (for 1-3-5)

(A) Mounting principle of plug set to allow joinable subbases to be supplied with 2 different pressures.



SET OF TRANSFER AND CONNECTION PLATES

• Set of transfer and connection plates to join ISO - VDMA joinable subbases of different sizes:

ISO 1 - ISO 2 set including:

- One transfer module to join ISO-VDMA joinable subbases with ISO 1 and ISO 2 **bottom** ports and connect the supply pressure (1) and exhaust (3-5) ports.
- One ISO 1 end plate (ports 1 - 3 - 5)
- One ISO 2 end plate (ports 1 - 3 - 5)

ISO 1 - ISO 3 set including the parts listed above appropriate for ISO 1 - ISO 3 transfer

ISO 1 - ISO 2 - ISO 3 set including:

- One transfer module to join ISO 1 and ISO 2 subbases
- One transfer module to join ISO 2 and ISO 3 subbases
- One ISO 1 end plate (ports 1 - 3 - 5)
- One ISO 3 end plate (ports 1 - 3 - 5)

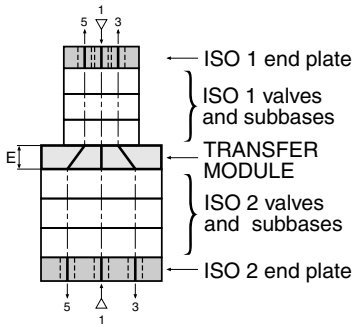
description	type	code	E (mm)	
Set of transfer and connection plates for ISO/VDMA joinable subbases with bottom ports	ISO 1 - ISO 2	35500199	20	
	ISO 1 - ISO 3	35500194	32	
	ISO 1 - ISO 2 - ISO 3	35500204	20 + 32	

JOUCOMATIC

DIMENSIONS (mm), WEIGHT (kg) 

ISO 1 - ISO 2 SPOOL VALVES
ON **SINGLE** SUBBASES WITH **SIDE** PORTS

	subbase code	port connections		
		12-14	1-2-4	3-5
ISO 1	35500076	G 1/8	G 1/4	G 1/4
	35500061		G 3/8	G 3/8
	35500382	G 3/8		G 3/8
ISO 2	35500560	G 1/8	G 3/8	G 3/8
	35500562		G 1/2	G 1/2

pilot	total weight			
	ISO 1		ISO 2	
	with 1 pilot	with 2 pilots	with 1 pilot	with 2 pilots
189	0,980	1,080	0,955	1,075
189 + coil m	1,100	1,320	1,075	1,315
190	1,040	1,200	1,011	1,195
195	1,045	1,210	1,020	1,205
374 + operator NK	1,725	2,570	1,700	2,565

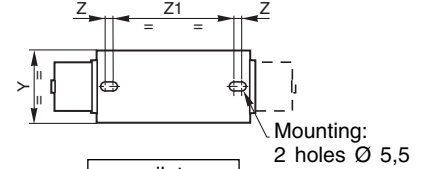

pilot 195

pilot 374 + operator NK

pilot 189 + coil **m**

pilot 189

pilot 190

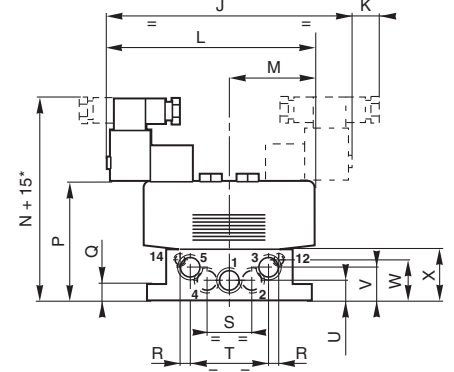
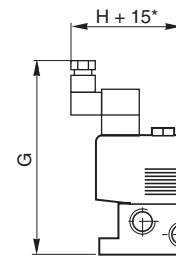
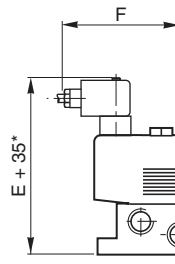
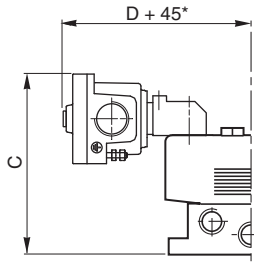
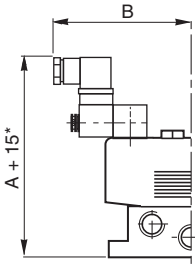

*For connector or coil removal

	A	B	C	D	E	F	G	H	J	K	L	M	N	P	Q	R	S	T	U	V	W	X	Y	Z	Z1
ISO 1	145	105	128	137	128	82	146	88	178	19	150	61	151	78	10	5	26	50	13,5	24	26	36	48	9	80
ISO 2	150	135	134	167	133	112	151	118	198	19	174	75	158	84	13	9	30	56	15	25	30,5	40	57	5	103

ISO 1 - ISO 2 SPOOL VALVES
ON **SINGLE** SUBBASES WITH **BOTTOM** PORTS

	subbase code	port connections		
		12-14	1-2-4	3-5
ISO 1	35500077	G 1/8	G 1/4	G 1/4
	35500069	with couplers Ø4 O.D. Ø8 O.D.		G 1/4
ISO 2	35500085	G 1/8	G 3/8	G 3/8

pilot	total weight			
	ISO 1		ISO 2	
	with 1 pilot	with 2 pilots	with 1 pilot	with 2 pilots
189	0,600	0,700	1,098	1,218
189 + bobine m	0,720	0,940	1,218	1,458
190	0,660	0,820	1,158	1,338
195	0,665	0,830	1,163	1,348
374 + tête NK	1,345	2,190	1,843	2,700

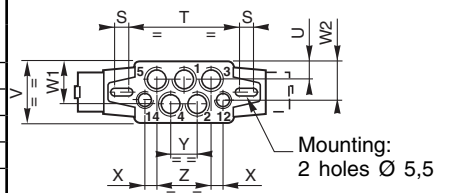

pilot 195

pilot 374 + operator NK

pilot 189 + coil **m**

pilot 189

pilot 190

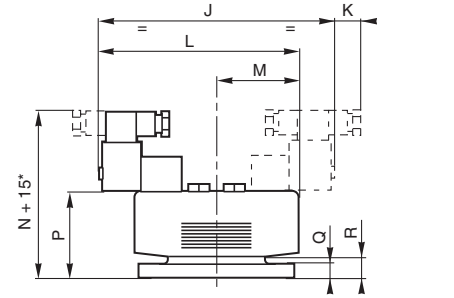
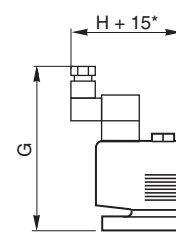
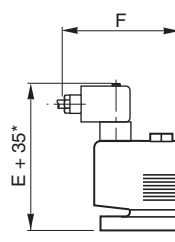
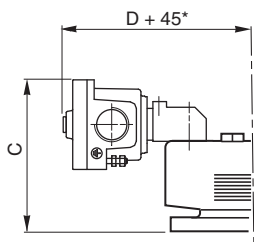
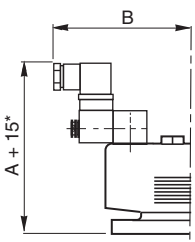

*For connector or coil removal

	A	B	C	D	E	F	G	H	J	K	L	M	N	P	Q	R	S	T	U	V	W1	W2	X	Y	Z
ISO 1	125	105	108	137	108	82	126	88	178	19	150	61	131	58	10	16	9	80	13,4	46	31	31	8,5	20	40
ISO 2	144	135	128	167	127	112	144	118	198	19	174	75	152	79	10	35	2	105	15	56	41	37	8,5	29	58

00500GB-2008/R01 Availability, design and specifications are subject to change without notice. All rights reserved.

DIMENSIONS (mm), WEIGHT (kg)

ISO 1 - ISO 2 SPOOL VALVES
ON JOINABLE SUBBASES WITH BOTTOM PORTS ACCORDING TO ISO/VDMA 24345

	code	port connections			
		12-14	1-2-4	3-5	
ISO 1	subbase	35500165	G 1/8	G 1/4	-
	2 end plates	35500166	-	-	G 3/8
ISO 2	subbase	35500169	G 1/8	G 3/8	-
	2 end plates	35500170	-	-	G 1/2

Set of end plates supplied with 3 plugs (for 1-3-5):
ISO 1 : G 3/8
ISO 2 : G 1/2

- ① Mounting: ISO 1 : 4 Ø M5
ISO 2 : 4 Ø M6
- ② Mounting: ISO 1 : 4 Ø M7
ISO 2 : 4 Ø M9

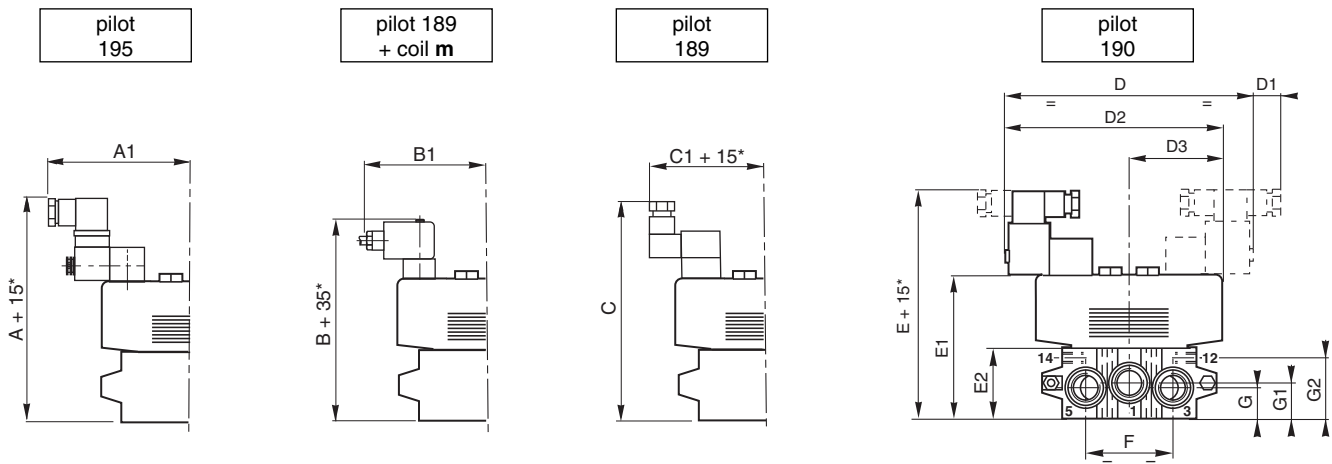
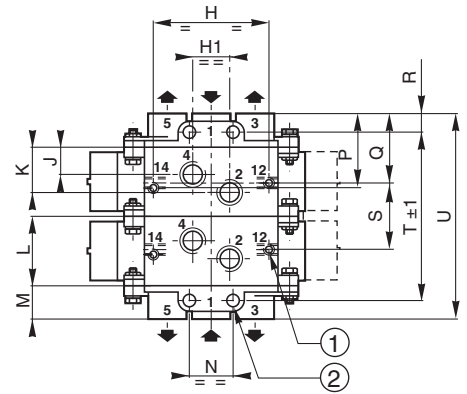

*For connector or coil removal

	A	A1	B	B1	C	C1	D	D1	D2	D3	E	E1	E2	F	G	G1	G2	H	H1	J	K	L	M	N	P	Q	R
ISO 1	155	105	138	82	156	88	178	19	150	61	161	88	46	56	21	24	36	71	26	20	29	43	22	28	46,5	43,5	11,5
ISO 2	158	135	141	112	159	118	198	19	174	75	164	93	47	68	22	23	37	86	30	23	33	56	26	35	57	54	13,5

number of subbases ISO 1	U	T±1	S	weight ISO 1 spool valves + 2 pilots + subbases + end plates			
				pilot			
				189	190	189 + m	195
3	173	150	86	2,850	3,200	3,560	3,225
4	216	193	129	3,500	4,000	4,480	4,030
5	259	236	172	4,100	4,700	5,300	4,740
6	302	279	215	4,750	5,500	6,220	5,550
7	345	322	258	5,350	6,200	7,040	6,255
8	388	365	301	6,000	7,000	7,960	7,065

pilot	weight of 1 pilot
189	0,120
189 + coil m	0,240
190	0,180
195	0,184

number of subbases ISO 2	V	U±1	T	weight ISO 2 spool valves + 2 pilots + subbases + end plates			
				pilot			
				189	190	189 + m	195
3	220	193	112	3,594	3,954	4,314	3,978
4	276	249	168	4,592	5,072	5,552	5,107
5	332	305	224	5,690	6,290	6,890	6,330
6	388	361	280	6,788	7,508	8,228	7,558
7	444	417	336	7,886	8,726	9,556	8,786
8	500	473	392	8,984	9,944	10,904	10,009

DIMENSIONS (mm), WEIGHT (kg)

ISO 3 SPOOL VALVES
ON **SINGLE** SUBBASES WITH **SIDE** PORTS

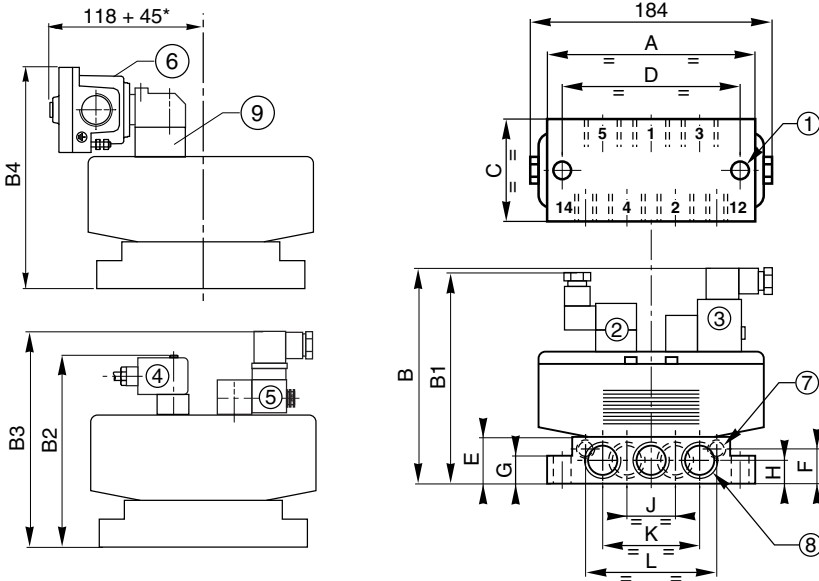

- ① Mounting: 2 Ø 6,6
- ② Solenoid valve series 189
- ③ Solenoid valve series 190/192
- ④ Solenoid valve series 189 + coil "m"
- ⑤ Solenoid valve series 195
- ⑥ Solenoid valve series 374 + operator NK
- ⑦ 2 ports (12-14): G 1/8
- ⑧ 5 ports (1-2-3-4-5): G 1/2 or G 3/4
- ⑨ Intermediate subbase code: 88119104 (required for mounting)

subbase code	connection	dimensions														
		A	B	B1	B2	B3	B4	C	D	E	F	G	H	J	K	L
35500171	G 1/2	149	165	158	147	164	162	71	136	32	22	18	17	32	68	90
35500192	G 3/4	149	183	176	165	182	180	71	136	50	40	18	20	36	80	92

ISO 3 SPOOL VALVES
ON **JOINABLE** SUBBASES WITH **BOTTOM** PORTS ACCORDING TO ISO/VDMA 24345

number of subbases	A	B±1	C	weight				
				spool valves + 2 pilots + subbases + end plates				
				pilot				
				189	190	189 + m	195	
2	206	167	71		4,140	4,380	4,620	4,400
3	277	238	142		5,740	6,100	6,460	6,125
4	348	309	213		7,340	7,820	8,300	7,850
5	419	381	284		8,940	9,540	10,140	9,580
6	490	451	355		10,540	11,260	11,980	11,321
7	561	522	426		12,140	12,980	13,035	13,035

Set of end plates supplied with 3 plugs G 1 (for 1-3-5)

pilot	weight of 1 pilot
189	0,120
189 + coil m	0,240
190	0,180
195	0,184
374 + operator NK	0,865

- ① 2 ports (4-2) : G 1/2
- ② Bottom mounting: 2 holes M8, depth 30
- ③ Front mounting: 4 holes, width 12
- ④ Solenoid valve series 189
- ⑤ Solenoid valve series 190/192
- ⑥ Solenoid valve series 189 + coil "m"
- ⑦ Solenoid valve series 195
- ⑧ Solenoid valve series 374 + operator NK
- ⑨ 2 ports (12-14) : G 1/8
- ⑩ 3 ports (1-3-5) : G 1
- ⑪ Intermediate subbase code: 88119104 (required for mounting)

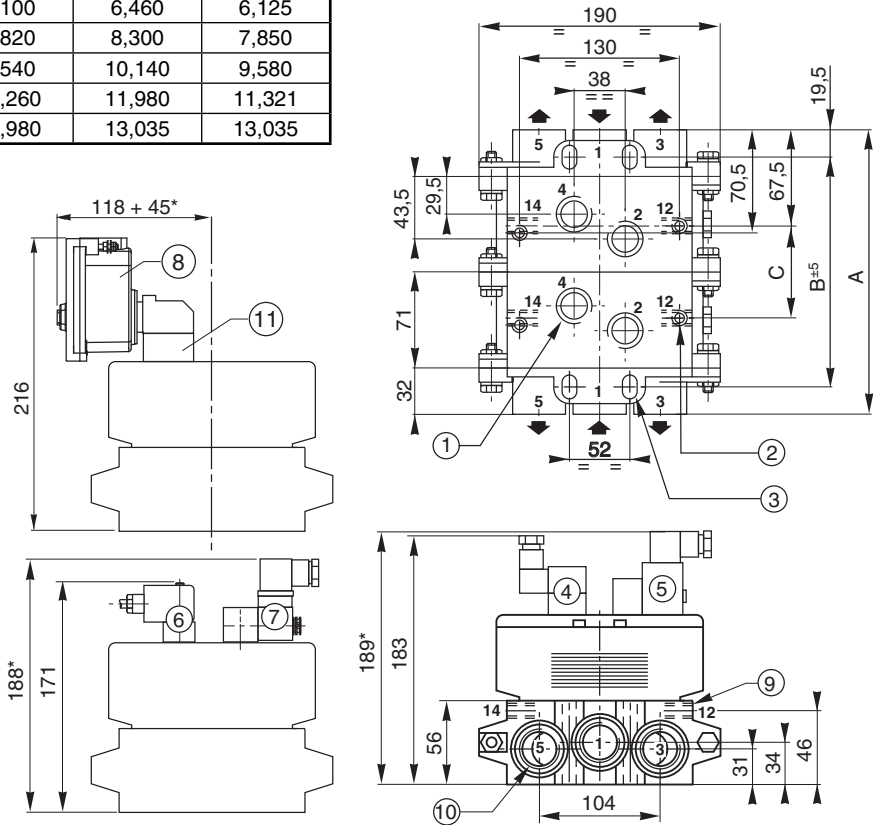

METAL JOINABLE SUBBASES

with side ports G 1/4

JOUCOMATIC



5/2-5/3

Series

355

Type

ISO sizes 1 and 2

GENERAL

This connection unit which consists of joinable subbases and accessories has the following 3 principal characteristics:

- Equipment with a **standard** interface for series 541 spool valves complying with international standard ISO 5599/1, size 1.
- Joinable subbases with **side ports**.
- Subbases fitted with selector plates for **integrated piping** of flow paths.

CONNECTION POSSIBILITIES

The joinable subbases with side ports offer many advantages:

- Various piping possibilities due to a large number of port connections.
- Simple panel assembly due to improved accessibility to connections.
- Easy maintenance.
- Reduced costs due to the removal of pivoting mounting chassis and a reduction in the number of fittings.
- Possibility of mounting directly onto the body of machines.
- Reduction in tubing lengths giving improved flow rates and response times.

These subbases allow the connection of outlet ports (2-4) and pilot ports (12 and 14) on both side faces as shown below.

The end plates allow the connection of the main pressure supply (1), the common exhausts (3 and 5) and the pilot ports (12 and 14) on face T1 or T2 or on faces T1 and T2.

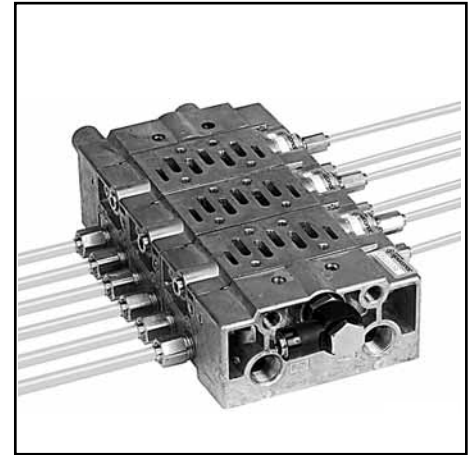

PIPING THROUGH THE END PLATES

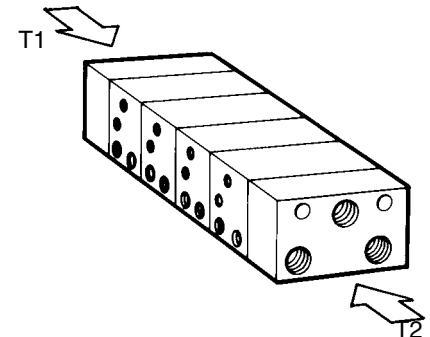

SAMPLE PIPING ARRANGEMENTS

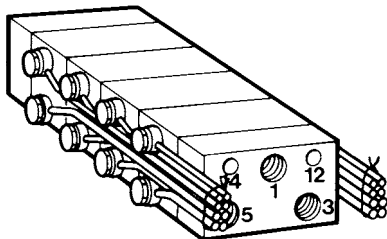

This arrangement allows the use of rotatable fittings

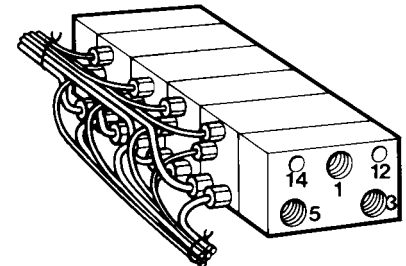
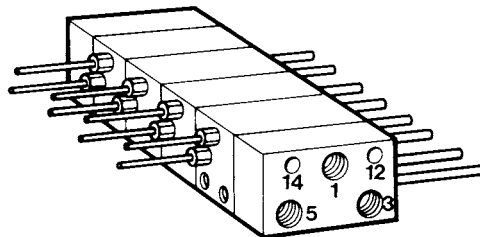

POSSIBLE FLOW PATHS

The subbases have 5 flow paths (1-3-5-12-14) all of which can be connected through the end plates of each manifold assembly..

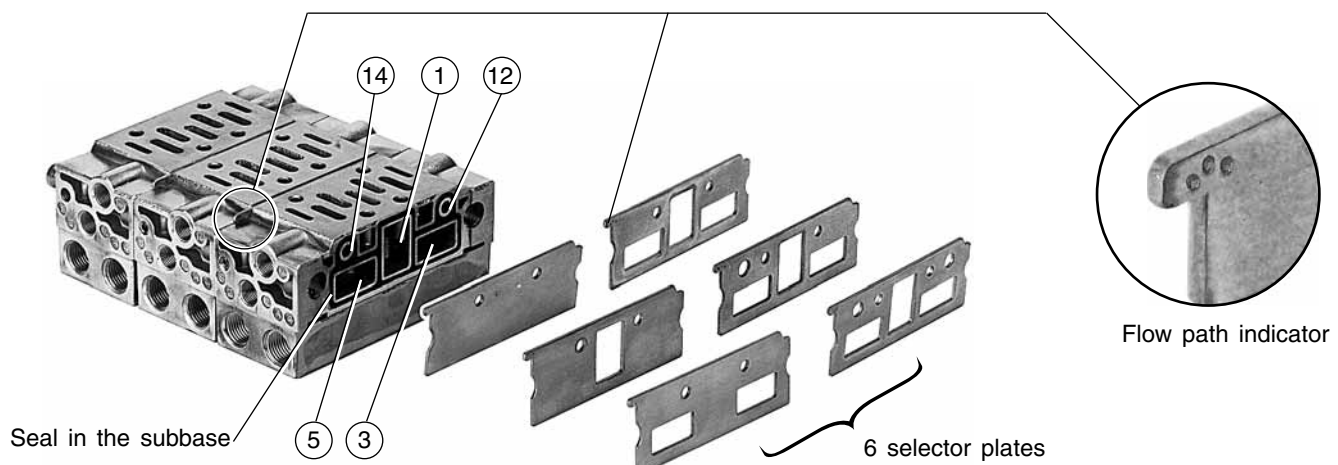

JOUCOMATIC

POSSIBLE FLOW PATHS

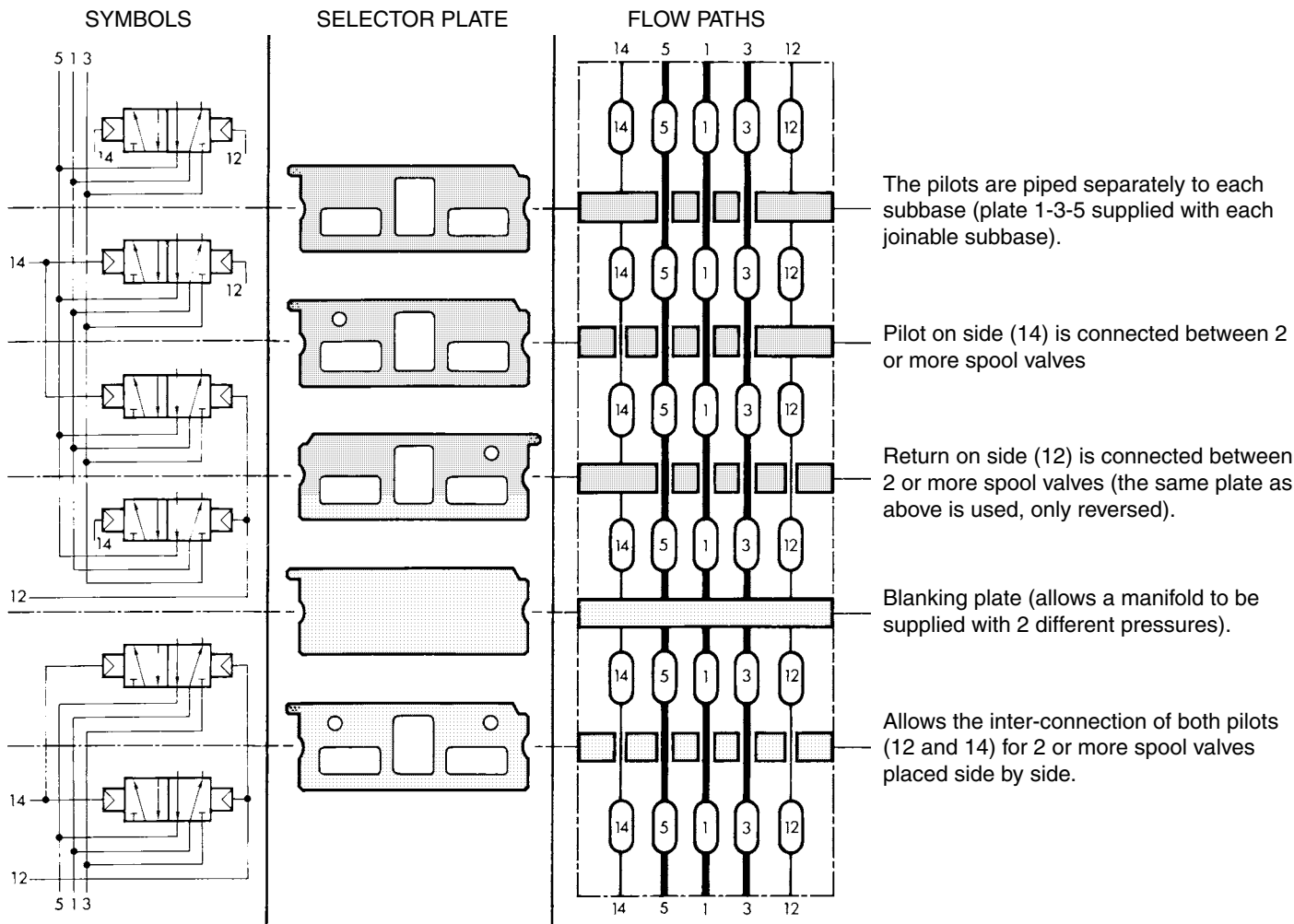

PIPING OF PRESSURE SUPPLY AND EXHAUSTS THROUGH THE END PLATES

STANDARD ASSEMBLY
Pressure supply and exhausts on the same side on one end plate.

Assembly with 2 different pressure supplies and common exhausts on both end plates.

Assembly with 1 pressure supply on 1 end plate and exhausts on both end plates.

Assembly with 1 pressure supply on 1 end plate and exhausts on the other end plate.

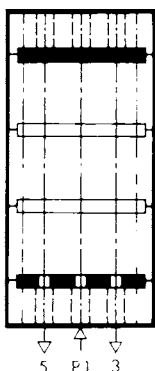

The selector plates supplied as standard with the subbases and end plates allow the assembly as shown above.

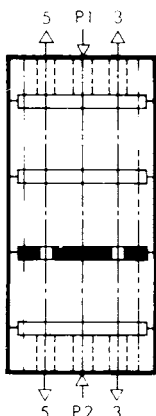

This assembly requires a selector plate with flow connected to ports 3 and 5.

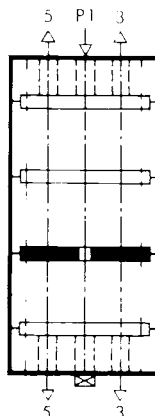

This assembly requires a selector plate with flow connected to port 1. The exhausts are blocked, while the common pressure supply is maintained. The supply port on the second end plate must be plugged.

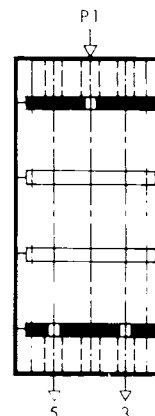

This assembly requires a selector plate with flow connected to port 1 to be mounted on one end plate + a selector plate with flow connected to ports 3 and 5 to be mounted on the other end plate. No ports need to be plugged.

CHOICE OF EQUIPMENT

description	parts list	ports					code	
		1-3-5		2-4		12-14	ISO 1	ISO 2
		ISO 1	ISO 2	ISO 1	ISO 2	ISO 1-2		
metal joinable subbase with side ports	1 subbase + 2 seals 1 selector plate (connects ports 1 - 3 - 5) 2 G 1/4 plugs 1 G 1/8 plug 2 assembly diabolos	-	-	G 1/4	G 1/2	G 1/8	35500088	35500102
set of 2 end plates	2 end plates + 2 seals 1 blank selector plate (no flow) 1 selector plate (connects ports 1 - 3 - 5) 2 assembly diabolos	G 3/8	G 3/4	-	-	G 1/8	35500087	35500101
blank selector plate (no flow)							88135501	88135506
selector plate (connects port 1)							88135512	88135513
selector plate (connects ports 3 and 5)							88135510	88135511
selector plate (connects ports 1 - 3 - 5)							88135502	88135507
selector plate (connects ports 1 - 3 - 5 and 1 pilot 12 or 14)							88135503	88135508
selector plate (connects ports 1 - 3 - 5 and 2 pilots 12 and 14)							88135504	88135509

SET OF TRANSFER AND CONNECTION PLATES

• Set of transfer and connection plates to join ISO 1 and ISO 2 metal joinable subbases with side ports:

- Set including:
- One transfer module to join ISO 1 and ISO 2 subbases
 - One ISO 2 end plate (ports 1 - 3 - 5 : G 3/4)
 - One ISO 1 end plate (ports 1 - 3 - 5 : G 3/8)

CHOICE OF EQUIPMENT

description	type	code	E (mm)	
Set of transfer and connection plates for metal joinable subbases with side ports	ISO 1 - ISO 2	35500390	30	

ACCESSORIES (see page 14)

JOUCOMATIC

DIMENSIONS (mm), WEIGHT (kg) 

SPOOL VALVES ON METAL JOINABLE SUBBASES

Side ports - ISO 1-2

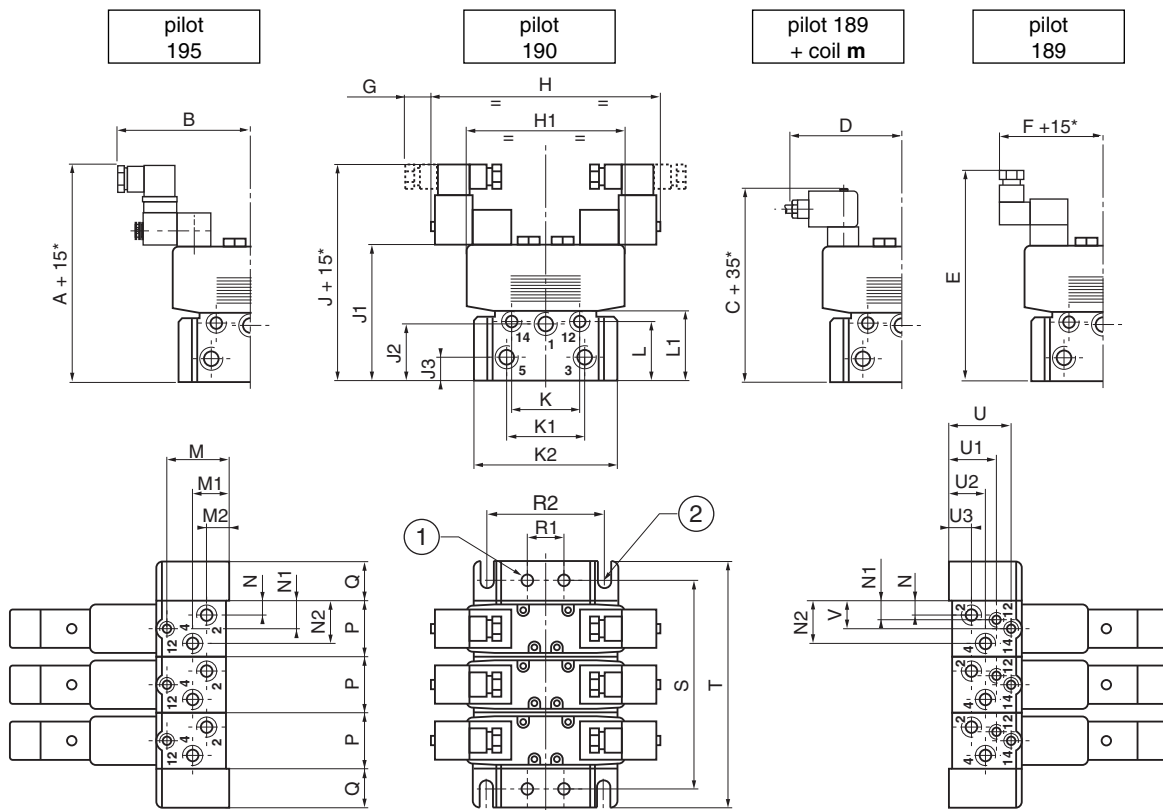

- ① ISO 1 mounting: 4 Ø 7 ; depth 53
- ② ISO 2 mounting: 4 slots Ø 8,5 ; depth 72

number of ISO 1 subbases	T	S	weight ISO 1 spool valves + 2 pilots + subbases + end plates			
			pilots			
			189	190	189 + m	195
2	146	106	3,66	3,90	4,14	3,92
3	189	149	4,86	5,22	5,58	5,24
4	232	192	6,06	6,54	7,02	6,57
5	275	235	7,26	7,86	8,46	7,90
6	318	278	8,46	9,18	9,9	9,23
7	361	321	9,66	10,50	11,34	10,56
8	404	364	10,86	11,82	12,78	11,88

number of ISO 2 subbases	T	S	weight ISO 2 spool valves + 2 pilots + subbases + end plates			
			pilots			
			189	190	189 + m	195
2	192	168	5,196	5,436	5,676	5,452
3	248	224	6,374	6,734	7,094	6,782
4	304	280	7,652	8,132	8,612	8,196
5	360	336	8,930	9,530	10,130	9,610
6	416	392	10,208	10,928	11,648	11,024
7	472	448	11,888	12,728	13,568	12,840
8	528	504	13,166	14,126	15,086	14,254

	A	B	C	D	E	F	G	H	H1	J	J1	J2	J3	K	K1	K2	L	L1	M	M1	M2	N	N1	N2	P	Q	R1	R2	U	U1	U2	U3
ISO 1	162	105	145	82	163	88	19	178	122	168	95	42	16	53	59	106	44	53	44	13	13	11	17,5	32	43	30	28	-	44	30	13	13
ISO 2	193	137	176	112	194	118	19	239	161	199	126	62	30	62	62	126	72	80	68	36	17	15	18	41	56	40	-	104	68	64	36	17

*For connector or coil removal

ASSEMBLY OF SUBBASES

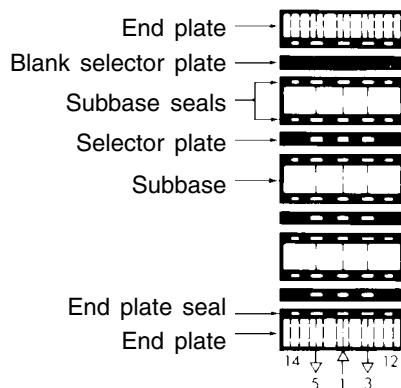

CONNECTION

End plates and subbases are connected together using a system of diabolos and grub screws.

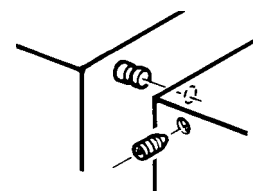

00500GB-2008/R01
Availability, design and specifications are subject to change without notice. All rights reserved.

CHOICE OF EQUIPMENT

designation		symbol	code				
			ISO 1	ISO 2	ISO 3		
Blanking plate to cover top face This plate allows later assembly of a spool valve			88135517	88135518	88135519		
Sandwich flow regulator This unit, fitted between a subbase and a spool valve, incorporates 2 flow regulators in the exhaust ports 3 and 5. The flow regulators can be used to control the speed of a cylinder Weight: ISO 1 : 0,230 kg - ISO 2 : 0,440 kg - ISO 3 : 1 kg			34600476	34600477	34600469		
Separate pressure supply module This unit, fitted between a joinable subbase and a spool valve, allows an individual valve to be supplied at a different pressure than that of the other spool valves. The main pressure feed for the subbases is not blocked when adding this module. Pressure supply port P : G 1/4			35500118	-	-		
Sandwich pressure regulator module This module, which is placed between a subbase and a spool valve, is designed to regulate the pressure on the valve's port as follows: - Adjustable pressure: 0,5 to 10 bar - G1/8 (A) port on top for pressure gauge connection - Locking adjustment knob of "Pull-Turn-Push" type ISO 1 : E=45 mm L=146 mm ISO 2 : E=60 mm L=180 mm ISO 3 : E=67 mm L=208 mm	on port 1 (pressure supply)	regulator flow at 6 bar: ISO 1 : 550 l/min weight: 0,387 kg ISO 2 : 1000 l/min weight: 1,680 kg ISO 3 : 2000 l/min weight: 2,210 kg		Button side 12	34600474	34600475	34600464
	on port 2	regulator flow at 6 bar: ISO 1 : 850 l/min weight: 0,387 kg ISO 2 : 1400 l/min weight: 1,680 kg ISO 3 : 2700 l/min weight: 2,210 kg		14	34600471	34600472	34600473
	on port 4	regulator flow at 6 bar: ISO 1 : 850 l/min weight: 0,387 kg ISO 2 : 1400 l/min weight: 1,680 kg ISO 3 : 2700 l/min weight: 2,210 kg			34600458	34600461	34600465
	on ports 2 and 4	regulator flow at 6 bar: ISO 1 : 850 l/min weight: 0,577 kg ISO 2 : 1400 l/min weight: 2,400 kg ISO 3 : 2700 l/min weight: 3,200 kg			34600459	34600462	34600466
	ISO 1 : E=45 mm L=146 mm ISO 2 : E=60 mm L=180 mm ISO 3 : E=67 mm L=208 mm	regulator flow at 6 bar: ISO 1 : 850 l/min weight: 0,577 kg ISO 2 : 1400 l/min weight: 2,400 kg ISO 3 : 2700 l/min weight: 3,200 kg			34600460	34600463	34600467
Pressure gauge Ø40 (0 - 12 bar)			34300014				
G1/8 bracket connection for pressure gauge mounting			88100617				

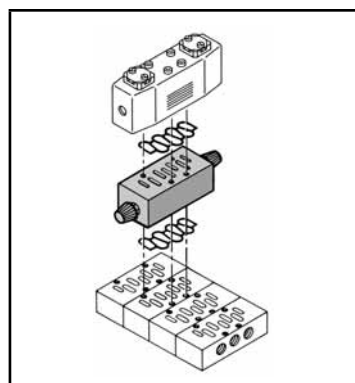

Sandwich flow regulator

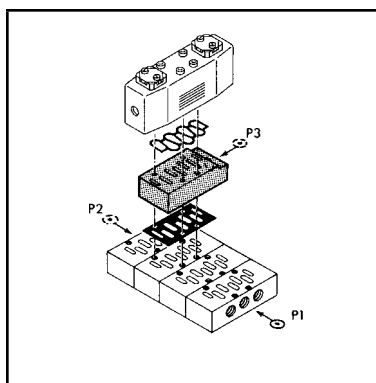

Separate pressure supply module

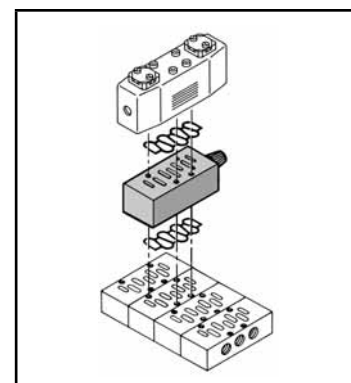

Sandwich pressure regulator module

00500GB-2008/R01 Availability, design and specifications are subject to change without notice. All rights reserved.