



PIC24™ Industrial Client Microcontroller for StackableUSB™ USB1124

Features



- ✓ 32MHz system clock
- ✓ 16 MIPS performance
- ✓ 256KB Flash, 16KB SRAM memory
- ✓ Single-cycle multiply and high-performance divide unit
- ✓ On-board RS232 transceiver
- ✓ Easy development with Microchip's MPLAB IDE
- ✓ Small 1.85" x 1.78" board
- ✓ -40° to +85°C operation



The USB1124 is a moderate-performance USB Client microcontroller board designed for low-power projects. Well-suited for applications confined to small, tight spaces, the 16 MIPS performance typically requires only 40mA power - figure small enough for battery-powered applications.

The USB1124 is powered by the PIC24 microcontroller. The unit is factory configured as a Client device so adding this module to any StackableUSB host SBC or controller expands the system's available control features to include a 16-channel 10-bit ADC, RS232, eight (8) programmable LEDs, and abundant digital I/Os.

Developers will especially appreciate the PIC24 easy-to-use and solidly supported software tools as they program and debug control functions for remote operation not requiring service from the single board computer or controller.

The 1.85" x 1.78" module is USB 2.0 compliant providing users the advantages of plug-and-play interfacing. The module stacks onto the top or bottom of any StackableUSB client single board computer or microcontroller forming a small, rugged, embeddable system, ideal for harsh environments. The USB1124 can be connected to desktop PCs and laptops via ICSP connector for development.

Software/Driver Support

Windows XP, Vista
MPLAB IDE
MPLAB C30 C Compiler
USB Client stack
Graphics & audio library
16- and 32-bit File System
Sample software

Compatible Hardware

StackableUSB Host single board
computers and microcontrollers
PC Host desktops and laptops
SPI, I2C, UART
ICE
ICD2, ICD3

Mounting/Packaging

1/4-Size 104™ Form Factor
Standoffs, STDOFFUSB

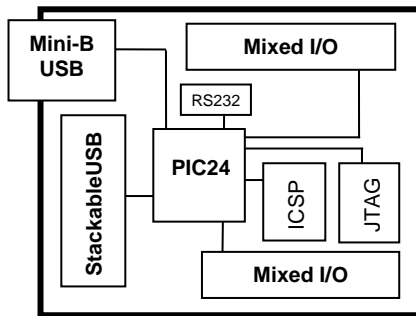

Specifications:

Mechanical:

- 1.85" x 1.78" StackableUSB
- ¼-Size 104™ Form Factor

Power Requirements:

- +5v ±5% at 40mA typical

Environmental:

- 40 to +85°C operating
- 40° to +85°C storage
- 5%-95% relative humidity, non-condensing

Processor:

- Modified Harvard architecture
- Up to 16MIPS operation at 32MHz
- 8MHz internal oscillator
- 17-bit by 17-bit single-cycle hardware multiplier
- 32-bit by 16-bit hardware divider
- 16-bit by 16-bit working register array
- C compiler optimized instruction set architecture with flexible addressing modes
- Linear program memory addressing, up to 12Mbytes
- Linear data memory addressing, up to 64Kbytes
- Two (2) address generation units for separate read and write addressing of data memory

Serial Ports:

- RS232 available from 20-pin header

LEDs/Switches:

- Eight (8) programmable user LEDs
- One (1) PB reset switch

Peripheral Features:

- Peripheral pin select:
 - Allows independent I/O mapping of many peripherals at run time
 - Continuous hardware integrity checking and safety interlocks prevent unintentional configuration changes
 - Up to 44 available pins (100-pin devices)
- Three (3) 3-Wire/4-Wire SPI modules (supports 4 Frame modes) with 8-level FIFO buffer
- Three (3) I2C modules support multi-master/slave modes and 7-bit/10-bit addressing
- Four (4) UART modules with:
 - RS485, RS232, LIN/J6202 protocols, and IrDA®
 - IrDA with on-chip hardware encoder and decoder
 - Auto-wake-up and auto-baud detect (ABD)
 - 4-level deep FIFO buffer
- Five (5) 16-bit timers/counters with programmable prescaler
- Nine (9) 16-bit capture inputs, each with a dedicated time base

- ❑ Nine (9) 16-bit compare/PWM outputs, each with a dedicated time base
- ❑ 8-bit parallel master port (PMP/PSP):
 - Up to 16 address pins
 - Programmable polarity on control lines
- ❑ Hardware real-time clock/calendar (RTCC):
 - Provides clock, calendar and alarm functions
- ❑ Programmable cyclic redundancy check (CRC) generator
- ❑ Up to 5 external interrupt sources

Special Microcontroller Features:

- ❑ Self-reprogrammable under software control
- ❑ 5.5V tolerant Input (digital pins only)
- ❑ Configurable open-drain outputs on digital I/O
- ❑ High-current sink/source (18 mA/18 mA) on all I/O
- ❑ Selectable power management modes:
 - Sleep, idle, and doze modes with fast wake-up
- ❑ Fail-safe clock monitor operation:
 - Detects clock failure and switches to on-chip, low-power RC oscillator
- ❑ Power-on reset (POR), power-up timer (PWRT), low-voltage detect (LVD) and oscillator start-up timer (OST)
- ❑ Flexible watchdog timer (WDT) with on-chip, low-power RC oscillator for reliable operation
- ❑ Brown-out reset (BOR)
- ❑ Flash program memory:
 - 10,000 erase/write cycle endurance (minimum)
 - 20-year data retention minimum
 - Selectable write protection boundary
 - Write protection option for Flash configuration words

Analog Features:

- ❑ 16-channel 10-bit analog-to-digital converter
- ❑ 500 KSPS conversion rate
- ❑ Conversion available during sleep, idle
- ❑ Three (3) analog comparators with programmable input/output configuration
- ❑ Charge time measurement unit (CTMU)

Debug Features:

- ❑ 2-wire ICSP interface with unintrusive access and real-time data exchange with application
- ❑ 4-wire MIPS standard enhanced JTAG interface
- ❑ Unintrusive hardware-based instruction trace
- ❑ IEEE Std 1149.2 compatible (JTAG) boundary scan

External Connections:

- ❑ StackableUSB
- ❑ Mini-B USB
- ❑ 20-pin header for RS232
- ❑ 6-pin ICSP debug port
- ❑ 6-pin JTAG debug port
- ❑ 2x50-pin headers for I/O and peripherals

Internal Electrical Interface:

- ❑ StackableUSB
- ❑ USB 1.1 & 2.0 compatible, full-speed

Development Kit:

- ❑ Base module
- ❑ Complete cable set
- ❑ Documentation, schematics, sample software

Ordering Information:

OEM Modules:

USB1124-ST	PIC24 Industrial Client Microcontroller with StackableUSB stack-through connector
USB1124-PC	PIC24 Industrial Client Microcontroller with Mini-B USB connector for PC connection
CS1124	Complete cable set

Related Products:

STDOFFUSB	StackableUSB standoff kit
BA4052	50-pin mixed I/O header breakout cable
BA2017	20-pin RS232 header to DB9 breakout cable
CA4142	ICSP programming/ debugging cable
CA4136	Type A to Mini-B USB cable
TB50550	50-pin screw terminal breakout board

Development Board Kits*

DK1124-ST	PIC24 Industrial Client Microcontroller with StackableUSB stack-through connector; Windows-ready development kit
DK1124-PC	PIC24 Industrial Client Microcontroller with Mini-B USB for PC connection; Windows-ready development kit

*See Development Kit Specifications