

FEATURED PRODUCT - SERIES RKW OPEN FRAME



DIN-RAIL MOUNTABLE

Family of RKW Models

The Open Frame series RKW are L-chassis, single-output power supplies in the 30, 50, 100 and 150-watt sizes. They provide d-c outputs from 3.3 volts to 48 volts from a-c mains 85-265V a-c and, except for the 30W models, provide power factor correction (PFC). All models feature overvoltage and overcurrent protection and, except for the 30W models, remote error sensing. The RKW conform to EN60950 following the provisions of the Low Voltage Directive 73/23/EEC and 93/68/EEC for the CE mark. Conducted EMI is suppressed to FCC Class B, VCCI Class B, EN 55011-B, and EN55022-B. All models meet the radiated noise limits of FCC Class B and EN55022 Class B.

FEATURES

- Output indicator, green LED.
- Remote error sensing.
- Overvoltage protection.
- Overcurrent protection.
- Power factor corrected, wide-range a-c input (30W models do not offer PFC).
- Optional metal enclosure.



CE RKW are CE marked per the Low Voltage Directive (LVD), EN60950.

RKW open frame models can be individually installed or may be combined into a custom power assembly for multi-output requirements. Please see pages 131-135 for details on Kepeco's Power Assembly Program.



RKW OPEN FRAME MODEL TABLE

MODEL	OUTPUT	ADJUSTMENT RANGE	OVP SETTING (1)	OUTPUT CURRENT	CURRENT LIMIT	SHORT CIRCUIT CURRENT	SWITCHING RIPPLE	NOISE	EFFICIENCY (%) TYPICAL	
	Volts		Volts	Amps -10+50°C	Amps(2)	Amps	mV p-p	mV p-p(3)	100V a-c	200V a-c
30 WATT MODELS										
RKW 3.3-7K	3.3	2.85-4.0	4.2-5.2	7.0	7.9	-	80	120	75	76
RKW 5-6K	5	4.0-5.8	6.0-6.9	6.0	6.3	-	80	120	77	78
RKW 12-2.5K	12	9.6-13.2	13.7-15.7	2.5	2.6	-	100	150	81	82
RKW 15-2K	15	12-16.5	17.0-19.0	2.0	2.1	-	100	150	81	83
RKW 24-1.3K	24	19.2-26.4	27.0-30.5	1.3	2.1	-	100	150	84	85
RKW 48-0.65K	48	38.4-52.8	55.0-60.0	0.65	0.68	-	130	200	84	85
50 WATT MODELS										
RKW 3.3-12K	3.3	2.85-4.0	4.2-5.2	12.5	13.1	16	80	120	71	73
RKW 5-10K	5	4.0-5.8	6.0-6.9	10	10.5	12.6	80	120	75	78
RKW 12-4.3K	12	9.6-13.2	13.7-15.7	4.3	4.5	5.6	100	150	78	80
RKW 15-3.5K	15	12-16.5	17.0-19.0	3.5	3.6	5.4	100	150	78	80
RKW 24-2.2K	24	19.2-26.4	27.0-30.5	2.2	3.3	6.2	100	150	79	82
RKW 48-1.1K	48	38.4-52.8	55.0-60.0	1.1	1.15	2.4	130	200	80	83
100 WATT MODELS										
RKW 3.3-25K	3.3	2.85-4.0	4.2-5.2	25	26.25	37.5	80	120	74	77
RKW 5-20K	5	4.0-5.8	6.0-6.9	20	21.0	27.5	80	120	77	82
RKW 12-8.5K	12	9.6-13.2	13.7-15.7	8.5	8.92	11.5	100	150	80	84
RKW 15-7K	15	12-16.5	17.0-19.0	7	7.35	10	100	150	80	84
RKW 24-4.5K	24	19.2-26.4	27.0-30.5	4.5	6.82	10	100	150	81	85
RKW 28-3.8K	28	22.4-30.8	32.0-35.0	3.8	3.99	7.5	100	150	81	85
RKW 48-2.1K	48	38.4-52.8	55.0-60.0	2.1	2.2	4.5	130	200	83	86
150 WATT MODELS										
RKW 3.3-35K	3.3	2.85-4.0	4.2-5.2	35	36.75	45	80	120	73	77
RKW 5-30K	5	4.0-5.8	6.0-6.9	30	31.5	37	80	120	77	82
RKW 12-13K	12	9.6-13.2	13.7-15.7	13	13.65	18	100	150	80	84
RKW 15-10K	15	12-16.5	17.0-19.0	10	10.5	14	100	150	80	84
RKW 24-6.5K	24	19.2-26.4	27.0-30.5	6.5	10.5	13	100	150	82	86
RKW 28-5.5K	28	22.4-30.8	32.0-35.0	5.5	5.78	9	100	150	82	86
RKW 48-3.3K	48	38.4-52.8	55.0-60.0	3.3	3.46	8.5	130	200	84	88

(1) An overvoltage shuts down the output. Recover by recycling a-c input.

(2) The current limit is rectangular. The 30W models have a "winker" circuit. After the overload is removed, output is automatically restored.

(3) Bandwidth 100MHz. Ripple and noise will be approximately 1.5 times these values in the operating temperature range -10~0°C.

The ripple and noise values tabulated are valid when the output is derated as shown in Figure 1 from 50~65°C.



RKW OPEN FRAME GENERAL SPECIFICATIONS

SPECIFICATION		RATING/DESCRIPTION	CONDITION
Temperature	Operating	-10 to +50°C	See rating curve, figure 1
	Start up	-20 to -10°C	
	Storage	-30 to +75°C	
Humidity	Operating	10 to 95% RH	Wet bulb temperature <35°C No condensation
	Storage	10 to 95% RH	
Vibration	5-10Hz	10mm amplitude	Sweep time 10 min. 1 hr each axis, not operating
	10-200Hz	2g	
Shock	Acceleration	60g 1/2 sine pulse duration 11 ±5 msec	3 shocks each axis, not operating
Withstand Voltage	Input-Output	a-c 3.0KV 1 min.	20mA
	Input-Ground	a-c 2.0KV 1 min.	20mA
	Output-Ground	a-c 500V 1 min.	20mA
Insulation Resistance	Input-Output	>100MΩ	500V d-c ⁽¹⁾
	Input-Ground	>100MΩ	500V d-c ⁽¹⁾
	Output-Ground	>100MΩ	500V d-c ⁽¹⁾
Safety Standards		UL1950	Certified by UL
		CSA C22.2 No. 950-95	
		EN60950	Certified by TÜV

(1) Normal temperature (15-35°C) and humidity (10% -85% RH).

RKW OPEN FRAME FUNCTIONS

DESCRIPTION	30W	50W	100W	150W
Overvoltage	yes	yes	yes	yes
Overcurrent	yes	yes	yes	yes
Thermal Protection	no	RKW 24-2.2K only	RKW 24-4.5K only	RKW 24-6.5K only
PFC	no	yes	yes	yes
Remote On-Off	no	no	no	no
External Voltage Adjust	no	yes	yes	yes
Remote Sense	no	yes	yes	yes
Parallel Operation	no	no	no	no
Master-Slave Operation	no	no	no	no
Series Operation	yes	yes	yes	yes
Current Balance	no	no	no	no
Operation Indicator	yes	yes	yes	yes
Power Fail Alarm	no	no	no	no
Fan	no	no	no	no

FIGURE 1
Output Power vs. Ambient Temperature

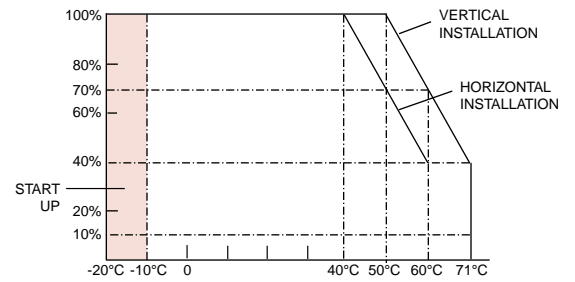
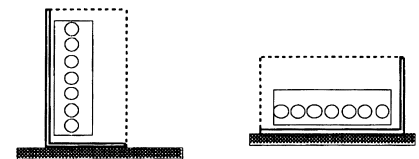
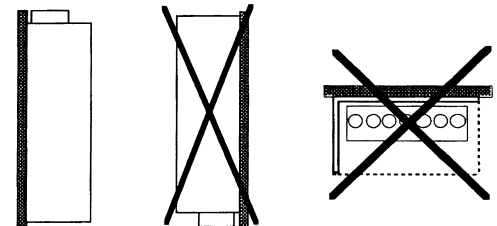

FIGURE 2
Mounting Directions
30, 50, 100, 150W Models



(A)
Standard Mounting

(B)



(C)

(D)

(E)

Apply power derating curve for (A), (B) and (C) mounting.
(D) and (E) are not available due to bad ventilation.



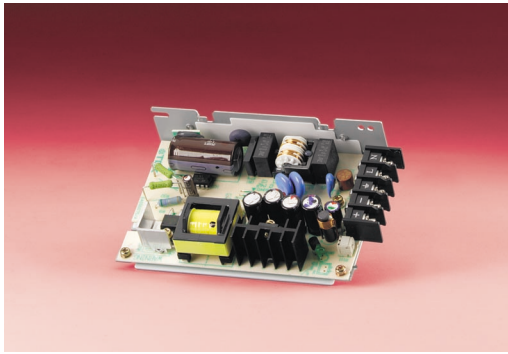

Model RKW 15-2K
30 Watts



Model RKW 3.3-12K
50 Watts

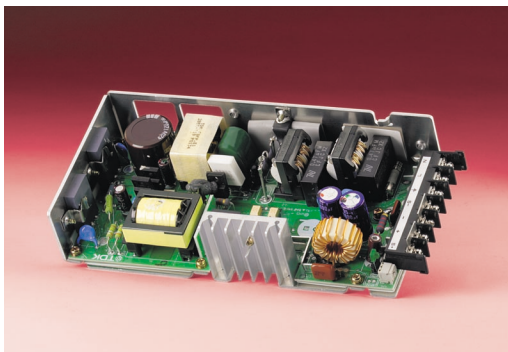

Model RKW 28-3.8K
100 Watts



Model RKW 48-3.3K
150 Watts

RKW OPEN FRAME COMMON INPUT CHARACTERISTICS

SPECIFICATIONS		RATING/DESCRIPTION	CONDITION
Input Voltage Range		85-265V a-c 110-370V d-c ⁽¹⁾	0-100% load, -10 to +50°C
Input Frequency Range		47-66Hz	0-100% load, -10 to +50°C
EMI	Conducted Noise	FCC Class B, VCCI-Class B EN55011-B, EN55022-B	
	Radiated Noise	FCC Class B, VCCI-Class B EN55011-B, EN55022-B	
Immunity To Electrostatic Discharge (ESD)		EN61000-4-2 Level 4	Normal operation
Radiated Susceptibility		EN61000-4-3 Level 3	Normal operation
Electrical Fast Transient		EN61000-4-4 Level 3	Normal operation
Surge Withstand		EN61000-4-5 Level 4	No damage
Conducted Susceptibility		EN61000-4-6 Level 3	Normal operation
Power Freq Mag Field		EN61000-4-8 Level 4	Normal operation
Voltage Dips, Short Interruptions and Voltage Variations		EN61000-4-11	Normal operation
Input Harmonics		EN61000-3-2	

(1) Safety agency approval applies only to a-c input operation.

RKW OPEN FRAME MODEL-SPECIFIC INPUT CHARACTERISTICS

SPECIFICATION	CONDITION	30W	50W	100W	150W
Input Current Amps	100-120V a-c	0.85	0.8	1.4	2
	200-240V a-c	0.45	0.4	0.7	1
(5V-48V models)					
Input Current Amps	100-120V a-c	0.7	0.7	1.2	1.75
	200-240V a-c	0.4	0.35	0.6	0.85
(3.3V models)					
Surge Current Amps, typ ⁽¹⁾	120V a-c	12.5	14	14	25
	240V a-c	25	28	28	50
Fuse Value Amps		2	2	3.15	5
Switching Frequency		60KHz	140KHz	135KHz	135KHz
Leakage Current typ (mA)	120V a-c	0.32	0.15	0.23	0.23
	240V a-c	0.5	0.3	0.45	0.45
Leakage Current max (mA)	120V a-c	0.55	0.24	0.35	0.35
	240V a-c	0.75	0.48	0.7	0.7
Power Factor	120V a-c	0.56	0.99	0.99	0.99
	200V a-c	0.42	0.95	0.95	0.95

(1) First surge only, not including the current flow into the EMI filter.



RKW OPEN FRAME COMMON OUTPUT CHARACTERISTICS

SPECIFICATIONS		RATING/DESCRIPTION	CONDITION
Source Effect	typ	0.1% (1)	85-132 or 170-265V a-c
	max	0.2% (1)	
Load Effect	typ	See model specific output ratings	0-100% load
Temperature Effect	typ	0.5%	-10°C to +65°C
	max	1.0%	
Combined Effect	typ	±0.9%	Source, load and temperature
	max	±1.8%	
Time Effect (drift)	typ	0.2%	0.5-8 hours
	max	0.5%	
Transient Recovery Characteristic	Excursion	±4% maximum	50-100% load transient time >50µsec
	Recovery	1millisecond max	
Start Up Time	100V a-c	See model specific output ratings	
Hold Up Time	100V a-c	See model specific output ratings	
Remote Error Sensing	3.3V models	0.15V	Voltage compensation per line
	5V models	0.25V	
	12-48V models	0.4V	

(1) 3.3V models: 150W - 0.15% typ, 0.3% max.

RKW OPEN FRAME MODEL-SPECIFIC OUTPUT CHARACTERISTICS

SPECIFICATION	CONDITION	30W	50W	100W	150W
Load Effect	typ	0.30%	0.1%	0.1%	0.1%
	max	0.60%	0.4%	0.4%	0.4%(1)
Start Up Time typ msec	100V a-c	600	300	300	150
	240V a-c	200	100	100	100
Start Up Time max msec	100V a-c	900	500	500	350
	240V a-c	400	200	200	200
Hold Up Time typ msec	100V a-c	35	40(2)	37	35(3)
	240V a-c	230	50(2)	45	40(3)
Hold Up Time min msec	100V a-c	20	20	20	20
	240V a-c	130	25	25	25

(1) 3.3V models: 0.45% typ, 0.9% max.

(2) 3.3V models at 100V a-c: 30 msec; at 240V a-c: 40 msec typ.

(3) 3.3V models at 100V a-c: 50 msec; at 240V a-c: 55 msec typ.

RKW OPEN FRAME MECHANICAL SPECIFICATIONS

SPECIFICATION		30W	50W	100W	150W
Dimensions English	Height	3.35"	3.35"	3.62"	3.62"
	Width	1.22"	1.22"	1.57"	1.97"
	Length	4.88"	5.9"	7.09"	7.68"
Dimensions Metric	Height	85mm	85mm	92mm	92mm
	Width	31mm	31mm	40mm	50mm
	Length	124mm	150mm	180mm	195mm
Weight	English	0.6 lb.	0.84 lb.	1.32 lb.	1.58 lb.
	Metric	275g	380g	600g	720g
Cooling		Convection			
Mounting		2 surface			

OUTLINE DIMENSIONAL DRAWINGS

Dimensions in light face type are in millimeters,
dimensions in bold face type are in inches.

30W Models

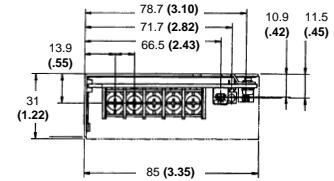

FRONT VIEW

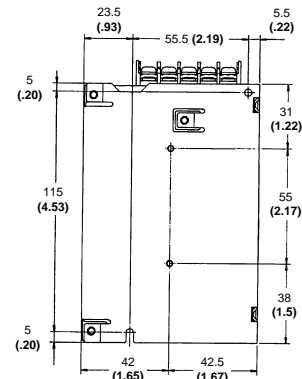

BOTTOM VIEW

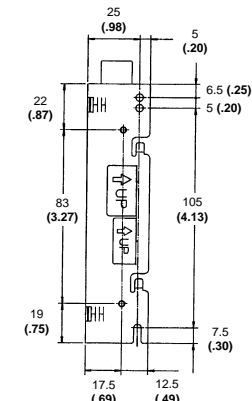

SIDE VIEW

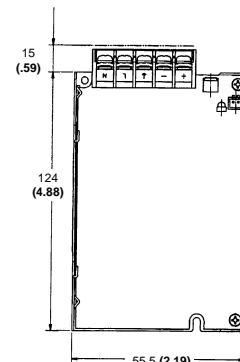

TOP VIEW

OUTLINE DIMENSIONAL DRAWINGS

Dimensions in light face type are in millimeters,
 dimensions in bold face type are in inches.

50W Models

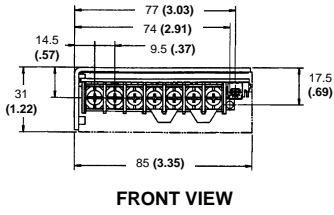

FRONT VIEW

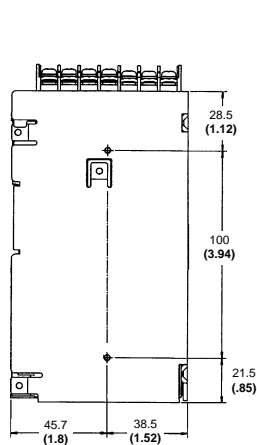

BOTTOM VIEW

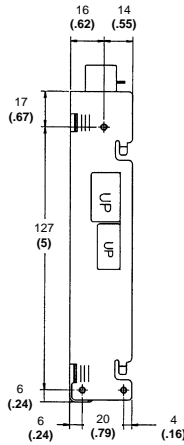

SIDE VIEW

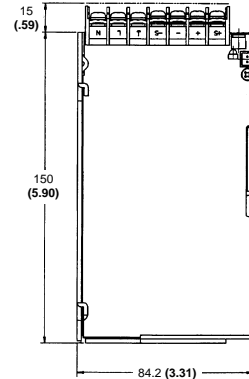

TOP VIEW

100W Models

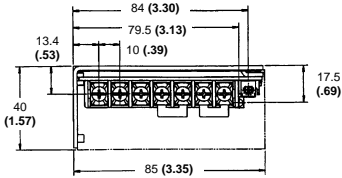

FRONT VIEW

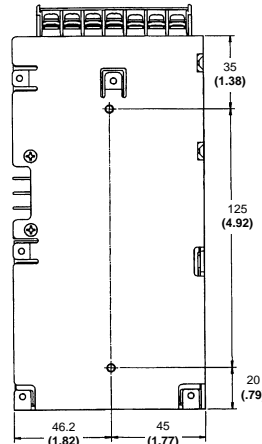

BOTTOM VIEW

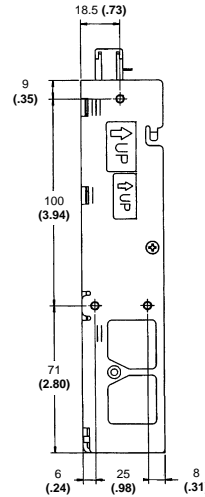

SIDE VIEW

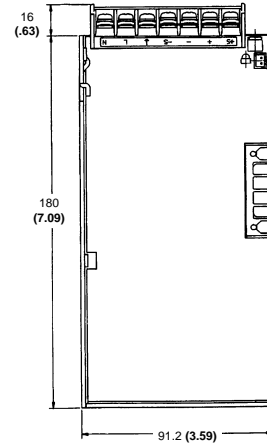

TOP VIEW

150W Models

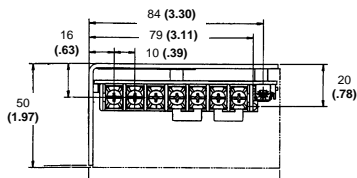

FRONT VIEW

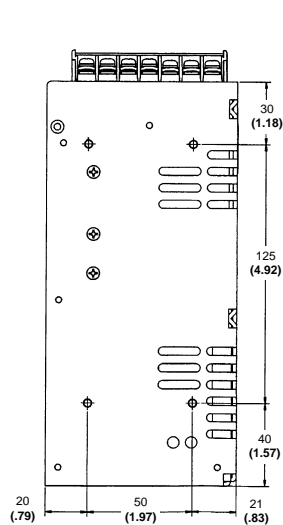

BOTTOM VIEW

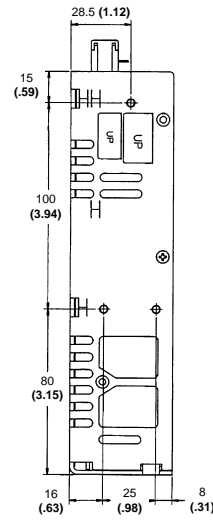

SIDE VIEW

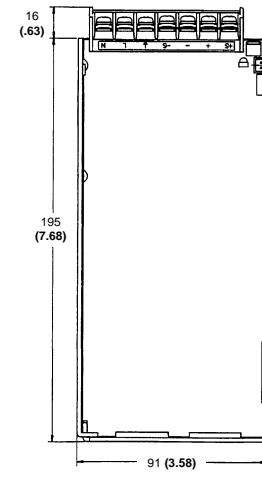

TOP VIEW