

Snap Action Switch











A

General-purpose Snap Action Switch

- High-capacity switch capable of handling 20 A loads with large inrush currents
- Directly switches such loads as motors, halogen lamps and solenoids
- Same shape as OMRON snap action switch model Z except in pin plunger position, yet endures inrush currents as large as 75 A.



Ordering Information

	Terminal	Solder terminal 	Screw terminal (-B) 
Actuator		Model	Model
Pin plunger		A-20G	A-20G-B
Short spring plunger		A-20GD	A-20GD-B
Panel mount plunger		A-20GQ	A-20GQ-B
Panel mount roller plunger		A-20GQ22	A-20GQ22-B
Panel mount cross roller plunger		—	A-20GQ21-B
Short hinge lever		A-20GV21	A-20GV21-B
Hinge lever		A-20GV	A-20GV-B
Short hinge roller lever		A-20GV22	A-20GV22-B
Hinge roller lever		A-20GV2	A-20GV2-B

Model Number Legend

A - 20 G □ - □
 1 2 3 4

1. Ratings

20: 20 A (250 VAC)

2. Contact Gap

G: 0.5 mm

3. Actuator

- None: Pin plunger
- D: Short spring plunger
- Q: Panel mount plunger
- Q21: Panel mount cross roller plunger
- Q22: Panel mount roller plunger
- V: Hinge lever
- V2: Hinge roller lever
- V21: Short hinge lever
- V22: Short hinge roller lever

4. Terminals

- None: Solder terminal
- B: Screw terminal (with toothed washer)

Specifications

Characteristics

Operating speed		0.01 mm to 1m/s (see note 1)
Operating frequency	Mechanical	240 operations/min
	Electrical	20 operations/min
Contact resistance		15 mΩ max. (initial value)
Insulation resistance		100 MΩ min. (at 500 VDC)
Dielectric strength		1,000 VAC, 50/60 Hz for 1 min between terminals of the same polarity 2,000 VAC, 50/60 Hz for 1 min between the current-carrying metal parts and the ground, and between each terminal and non-current-carrying metal parts
Vibration resistance	Malfunction	10 to 55 Hz, 1.5-mm double amplitude (See note 2)
Shock resistance	Destruction	1,000 m/s ² max.
	Malfunction	300 m/s ² max. (See notes 1 and 2)
Degree of protection		IP00
Degree of protection against electric shock		Class I
Proof tracking index (PTI)		175
Ambient operating temperature		-25°C to 80°C (with no icing)
Ambient operating humidity		35% to 85%RH
Service life	Mechanical	1,000,000 operations min.
	Electrical	500,000 operations min.
Weight		Approx. 22 to 58 g

Note: 1. The value is for the pin plunger.

2. Malfunction: 1 ms max.

Operating Characteristics

Characteristics	A-20G-B	A-20GD-B	A-20GQ-B	A-20GQ22-B	A-20GQ21-B	A-20GV21-B	A-20GV-B	A-20GV22-B	A-20GV2-B
OF	400 to 625 g			630 g max.		160 g	70 g	160 g	90 g
RF min.	285 g			280g		42 g	14 g	42 g	14 g
PT max.	1.3 mm					6.5 mm	15.9 mm	6.3 mm	12 mm
OT min.	0.25 mm	3 mm	5.6 mm	3.58 mm		1.2 mm	4 mm	1.2 mm	2.4 mm
MD max.	0.2 mm			0.35 mm		1.2 mm	2.4 mm	1.2 mm	2.2 mm
OP	16.3±0.4 mm	26.2±0.5 mm	21.8±0.8 mm	33.4±1.2 mm		19±0.8 mm	19±0.8 mm	29.8±0.8 mm	30.2±0.8 mm

Ratings

Rated voltage (V)	Non-inductive load (A)				Inductive load (A)			
	Resistive load		Lamp load		Inductive load		Motor load	
	NC	NO	NC	NO	NC	NO	NC	NO
125 VAC	20		3	7.5	20		12.5	
250 VAC	20		3	7.5	20		8.3	
500 VAC	15			4	10		2	
8 VDC	20		3	1.5	20		12.5	
14 VDC	20		3	1.5	15		12.5	
30 VDC	6		3	1.5	5		5	
125 VDC	0.5		0.5	0.5	0.05		0.05	
250 VDC	0.25		0.25	0.25	0.03		0.03	

Note: 1. The above values are for steady-state current.

2. Inductive load has a power factor of 0.4 min. (AC) and a time constant of 7 ms max. (DC).

3. Lamp load has an inrush current of 10 times the steady-state current.

4. Motor load has an inrush current of 6 times the steady-state current.

5. The ratings values apply under the following test conditions:

(1) Ambient temperature: 20±2°C

(2) Ambient humidity: 65±5%RH

(3) Operating frequency: 20 operations/min

Contact Specification

Contacts	Shape	Rivet
	Material	Silver alloy
	Gap (standard value)	0.5 mm
Inrush current	NC	75 A max.
	NO	75 A max.

Safety Standards Ratings

UL/CSA (General ratings only)

Rated voltage	A-20G
125 VAC	1 HP and 10 A "L" (Tungsten)
250 VAC	2 HP
480 VAC	20 A
125 VDC	0.5 A
250 VDC	0.25 A

Engineering Data

Mechanical Durability (A-20G)

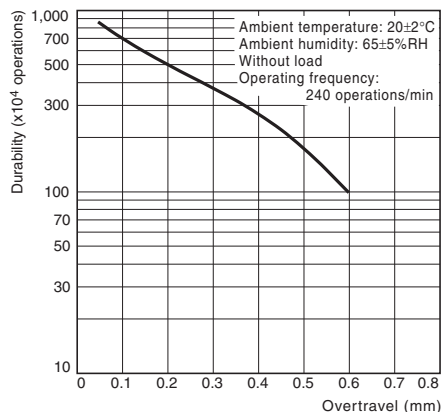

Electrical Durability (A-20G)

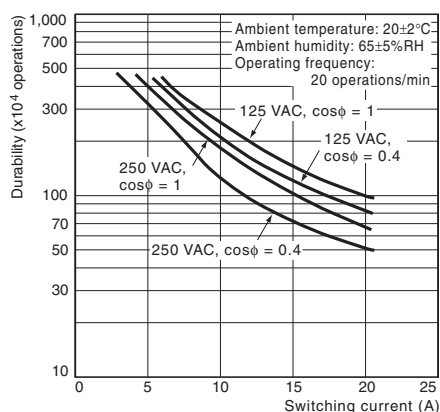

Structure

Contact Form (SPDT)



Dimensions

Note: Unless otherwise specified, all units are in millimeters and a tolerance of ± 0.4 mm applies to all dimensions.

Terminals

Screw Terminals (-B)

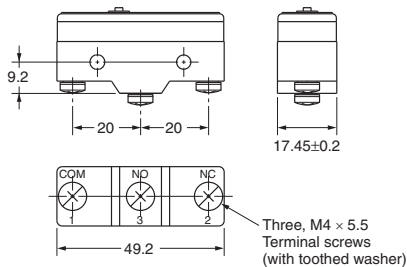

Solder Terminal (Blank)

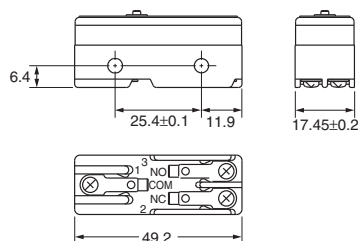

Note: Appropriate terminal screw tightening torque: 0.78 to 1.18 N-m.

Mounting Holes

All switches can be mounted using M4 mounting screws with plane washers or spring washers to securely mount the Switch. Tighten the screws to a torque of 1.18 to 1.47 N-m.

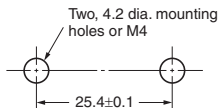

Versions with panel mount plungers can be panel mounted via the plunger, provided that the hexagonal nut of the actuator is tightened to a torque of 2.94 to 4.9 N-m.

Panel Mount Plunger

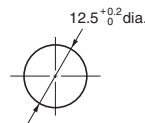

Panel Mount Roller Plunger

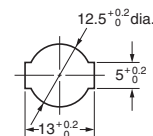

Note: Mount using either the side mounting holes or the panel mount plunger, not both. If using the side mounting holes, then remove the hexagonal nut(s) from the panel mount plunger.

Accessories (Terminal Covers, and Separators): Refer to 'Z/A/X/DZ Common Accessories' datasheet

Note: 1. All drawings show the switches with screw terminals. For solder terminals, remove the “-B” from the end of the part number
 2. Unless otherwise specified, all units are in millimeters and a tolerance of ± 0.4 mm applies to all dimensions.

Pin Plunger
A-20G-B

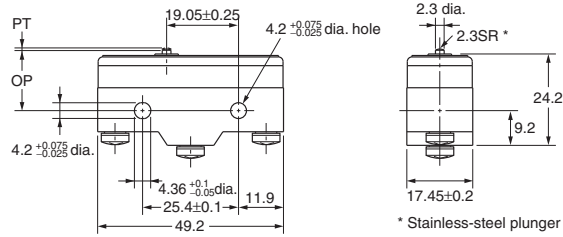

Short Spring Plunger
A-20GD-B

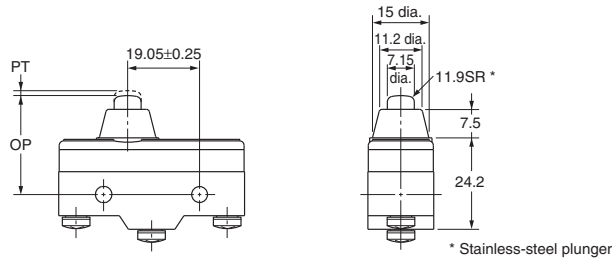
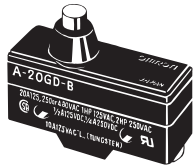

Panel Mount Plunger
A-20GQ-B

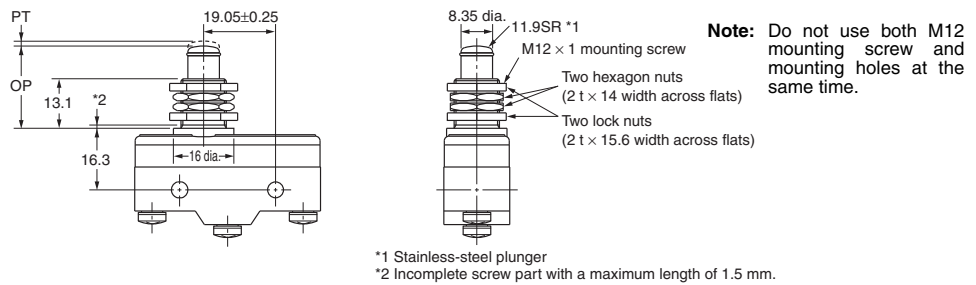
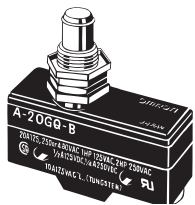

Panel Mount Roller Plunger
A-20GQ22-B

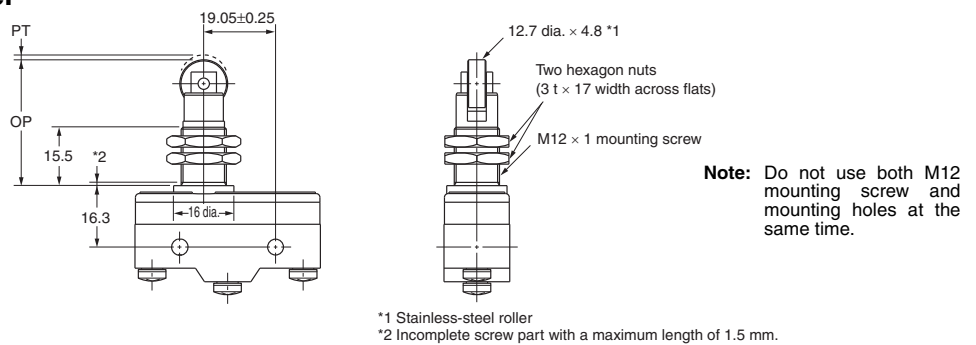
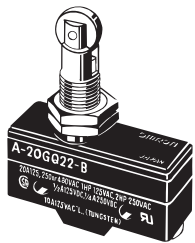

Panel Mount Cross Roller Plunger
A-20GQ21-B

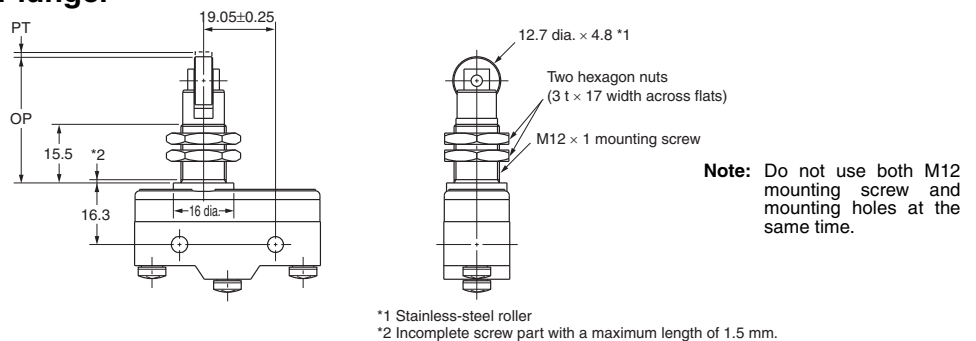
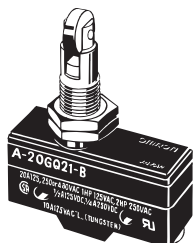

Note: 1. All drawings show the switches with screw terminals. For solder terminals, remove the “-B” from the end of the part number
 2. Unless otherwise specified, all units are in millimeters and a tolerance of ± 0.4 mm applies to all dimensions.

Short Hinge Lever

A-20GV21-B

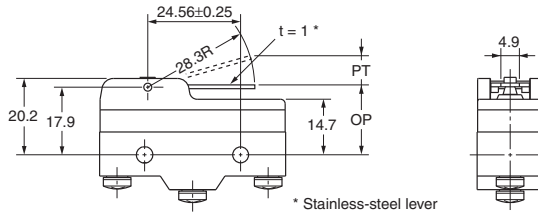
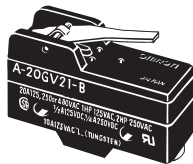

Hinge Lever

A-20GV-B

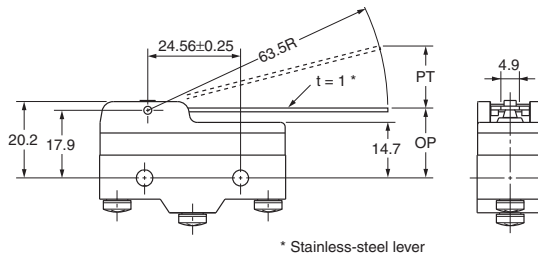
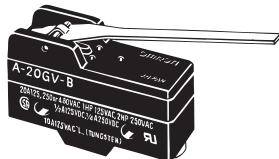

Short Hinge Roller Lever

A-20GV22-B

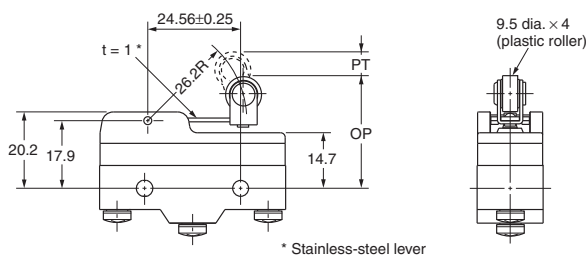

Hinge Roller Lever

A-20GV2-B

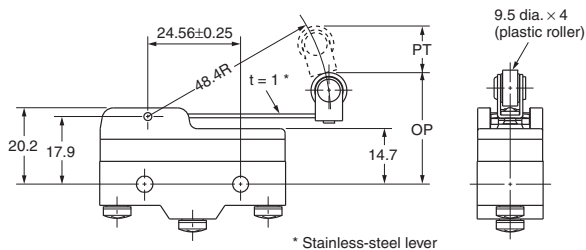
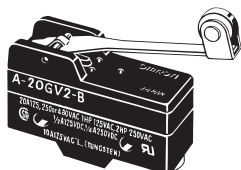

Safety Precautions

Be sure to read the precautions and information common to all Snap Action and Detection Switches, contained in the Technical User's Guide, "Snap Action Switches, Technical Information" for correct use.

Precautions for Safe Use

Terminal Connection

When soldering lead wires to the Switch, make sure that the capacity of the soldering iron is 60 W maximum. Do not take more than 5 s to solder any part of the Switch. The characteristics of the Switch will deteriorate if a soldering iron with a capacity of more than 60 W is applied to any part of the Switch for 5 s or more.

Operation

- Make sure that the switching frequency or speed is within the specified range.
1. If the switching speed is extremely slow, the contact may not be switched smoothly, which may result in a contact failure or contact welding.
 2. If the switching speed is extremely fast, switching shock may damage the Switch soon. If the switching frequency is too high, the contact may not catch up with the speed.
- The rated permissible switching speed and frequency indicate the switching reliability of the Switch.
- The life of a Switch is determined at the specified switching speed. The life varies with the switching speed and frequency even when they are within the permissible ranges. In order to determine the life of a Switch model to be applied to a particular use, it is best to conduct an appropriate durability test on some samples of the model under actual conditions.
- Make sure that the actuator travel does not exceed the permissible OT position. The operating stroke must be set to 70% to 100% of the rated OT.

Precautions for Correct Use

Mounting Location

- Do not use the switch alone in atmospheres such as flammable or explosive gases. Arcing and heat generation associated with switching may cause fires or explosions.
- Switches are generally not constructed with resistance against water. Use a protective cover to prevent direct spraying if the switch is used in locations subject to splashing or spurting oil or water, dust adhering.

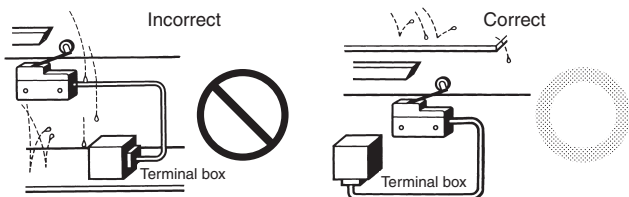

- Install the switch in a location that is not directly subject to debris and dust from cutting. The actuator and the switch body must be protected from accumulated cutting debris and dirt.



- Do not use the switch in locations subject to hot water (greater than 60°C) or in water vapor.
- Do not use the switch outside the specified temperature and atmospheric conditions. The permissible ambient temperature depends on the model. (Refer to the specifications in this catalog.) Sudden thermal changes may cause thermal shock to distort the switch and result in faults.

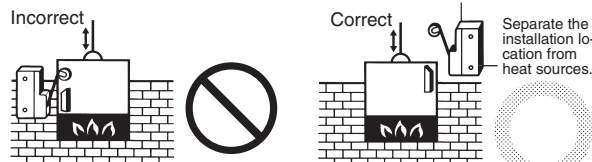

- Mount a cover if the switch is to be installed in a location where worker inattention could result in incorrect operation or accidents.



- Subjecting the switch to continuous vibration or shock may result in contact failure or faulty operation due to abrasion powder and in reduced durability. Excessive vibration or shock will cause the contacts to operate malfunction or become damaged. Mount the switch in a location that is not subject to vibration or shock and in a direction that does not subject the switch to resonance.
- If silver contacts are used with relatively low frequency for a long time or are used with microloads, the sulfide coating produced on the contact surface will not be broken down and contact faults will result. Use a microload switch that uses gold contacts.
- Do not use the switch in atmospheres with high humidity or heat or in harmful gases, such as sulfide gas (H₂S, SO₂), ammonia gas (NH₃), nitric acid gas (HNO₃), or chlorine gas (Cl₂). Doing so may impair functionality, such as with damage due to contacting faults or corrosion.
- The switch includes contacts. If the switch is used in an atmosphere with silicon gas, arc energy may cause silicon oxide (SiO₂) to accumulate on the contacts and result in contact failure. If there is silicon oil, silicon filling, silicon wiring, or other silicon products in the vicinity of the switch, use a contact protection circuit to limit arcing and remove the source of the silicon gas.

Panel-mounting model (A-20G□)

- If a Switch is side-mounted with screws, remove the hexagonal nut of the actuator.
- If a Switch is side-mounted and secured with screws, make sure that the angle or speed of the actuating object is not excessively large or too high, otherwise the Switch may be damaged.
- If a Switch is panel-mounted, pay utmost attention to make sure that the actuating speed or OT distance is not excessively high or large. Not doing so may damage the Switch.

A large grid of 20 columns and 30 rows of small squares, intended for taking notes. The grid is composed of thin, light gray lines forming a uniform pattern of small squares across the page.

All sales are subject to Omron Electronic Components LLC standard terms and conditions of sale, which can be found at http://www.components.omron.com/components/web/webfiles.nsf/sales_terms.html

ALL DIMENSIONS SHOWN ARE IN MILLIMETERS.
To convert millimeters into inches, multiply by 0.03937. To convert grams into ounces, multiply by 0.03527.

OMRON[®]

**OMRON ELECTRONIC
COMPONENTS LLC**

55 E. Commerce Drive, Suite B
Schaumburg, IL 60173

847-882-2288

OMRON ON-LINE

Global - <http://www.omron.com>

USA - <http://www.components.omron.com>