

INPUT CHARACTERISTICS:**MPN4-6810F**

- VOLTAGE: AC 90 ~ 260V (full range), 60 - 50HZ
- INPUT CURRENT: 15.0 A / 7.5A (RMS) FOR 115 / 230 VAC
- INRUSH CURRENT: 35 / 70 A MAX. @ 115 / 230 VAC

OUTPUT CHARACTERISTICS:

OUTPUT VOLTAGE	OUTPUT CURRENT		REGULATION		OUTPUT
	MIN. [A]	MAX. [A]	LOAD	LINE	RIPPLE & NOISE MAX. [P-P]
5V	9.0	75	± 5%	± 1%	50mV
12V	4.5	51	± 6%	± 1%	100mV
-5V	0.15	1.5	±11%	± 1%	100mV
-12V	0.15	1.5	±11%	± 1%	120mV
3.3V	3	60	± 5%	± 1%	50mV
+5VSB	0.15	1.6	± 5%	± 1%	50mV

REMARKS: MAX. COMBINED OUTPUT OF +5V AND +3.3V: 105A
MAX. TOTAL OUTPUT: 810W

SPECIFICATION:

- TEMPERATURE RANGE: OPERATING 0 --- 40
- HOLD UP TIME: 16 ms MINIMUM AT FULL LOAD & NORMAL INPUT VOLTAGE
- DIELECTRIC WITHSTAND: INPUT / OUTPUT 1500 VAC FOR 1 SECOND
INPUT TO FRAME GROUND 1500 VAC FOR 1 SECOND
- EFFICIENCY: 68% TYPICAL
- POWER GOOD SIGNAL: ON DELAY 100 ms TO 500 ms, OFF DELAY 1 ms
- OVER LOAD PROTECTION: 130 +/- 20%
- OVER VOLTAGE PROTECTION: **+5V → 5.74V ~ 7V, 12V → 14.3V ~ 15.6V, 3.3V → 3.76 ~ 4.3V, 5VSB → 5.74 ~ 7V**
- SHORT CIRCUIT PROTECTION: **Shut down and latch off**
- EMI NOISE FILTER: FCC CLASS B, CISPR22 CLASS B
- SAFETY: UL 1950, CSA 22.2 MP/ 950, TÜV IEC 950
- REMOTE ON / OFF CONTROL
THE UNIT SHALL ACCEPT A LOGIC OPEN COLLECTOR LEVEL WHICH WILL DISABLE / ENABLE ALL THE OUTPUT VOLTAGE (EXCLUDE +5V STANDBY), AS LOGIC LEVEL IS LOW, OUTPUTS VOLTAGE WERE ENABLE, AS LOGIC LEVEL IS HIGH, OUTPUTS VOLTAGE WERE DISABLE.
- N + 1 REDUNDANCY FUNCTION
- HOT-SWAPPABLE FUNCTION
- CURRENT / BALANCE LOAD SHARING DESIGN
- 3.3V / 5V REMOTE SENSING
- ISOLATION: BUILT-IN IN THE POWER MODULE
- COOLING: TWO 40mm DC FANS
- DIMENSION: 230 (D) X 164 (W) X 200.6 (H) mm
- CONNECTION: 48 PINS CONNECTOR (EPT PART NO. 109-40064 OR EQUIVALENT)
- ACTIVE POWER FACTOR CORRECTION MEET IEC 1000-3-2

修訂 REVISIONS		日期 DATE
版次 REV.	記述 DESCRIPTION	
A2	深度加長	MAR/11/99
A3	增加側面抽牙	DEC-24-1999

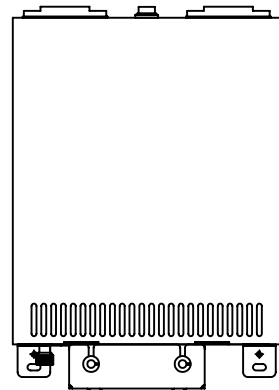
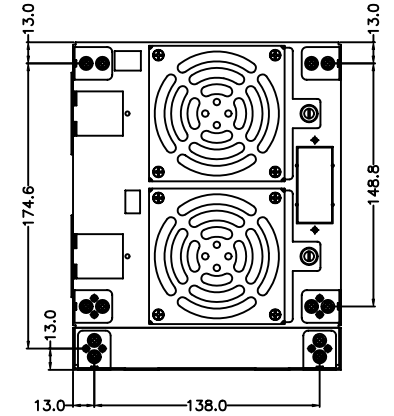
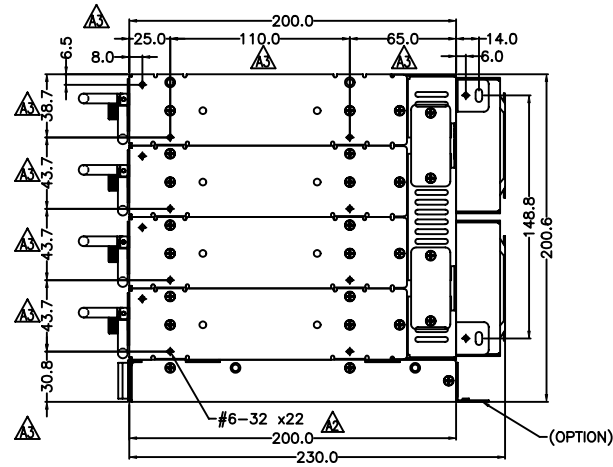
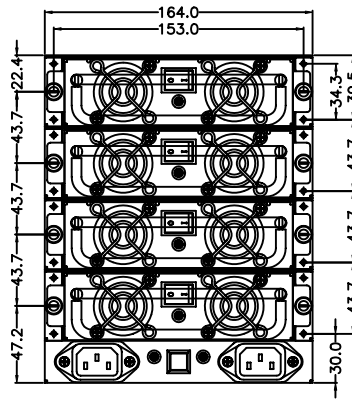
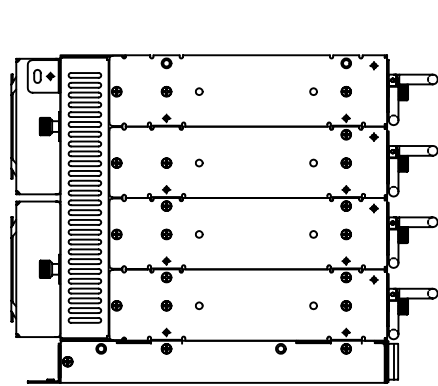
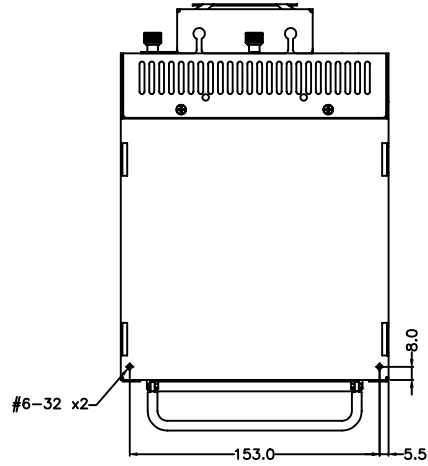

容許公差: TOLERANCES:	材料規格: MATERIAL:
.XXX ±.025	
.XX ±.100	
.X ±.250	

投影法:
PROJECTION:
第三角法

核准者: APPROVE BY:	日期: DATE:
審核者: CHECK BY:	日期: DATE:
繪圖者: DRAW BY:	日期: DATE:

品名: MODEL NO:	料號: PART NO:
圖號: DRAW NO:	檔號: FILE NO:
單位: UNITS:	規格: SPEC:

新巨企業股份有限公司
ZIPPY TECHNOLOGY CORP.
 POWER DIVISION

品名: **MPN4 外觀尺寸圖(1)**
 料號: **MPN4MA00**
 圖號: **MPN4MA00** 檔號: **MPN4MA00**
 單位: mm 規格: A0 編號: OF
 版次: A3 規格: A0 編號: OF
 REV. NO: A3 SPEC: A0 SHEET: OF