

# Carlton® Floor Boxes and Covers

*Round*  
*1-, 2-, and 3-Gang*  
*Rectangular*  
*Residential –*  
*Fully Adjustable*  
*Drop-In*  
*Brass Covers*  
*Nonmetallic*  
*Covers*

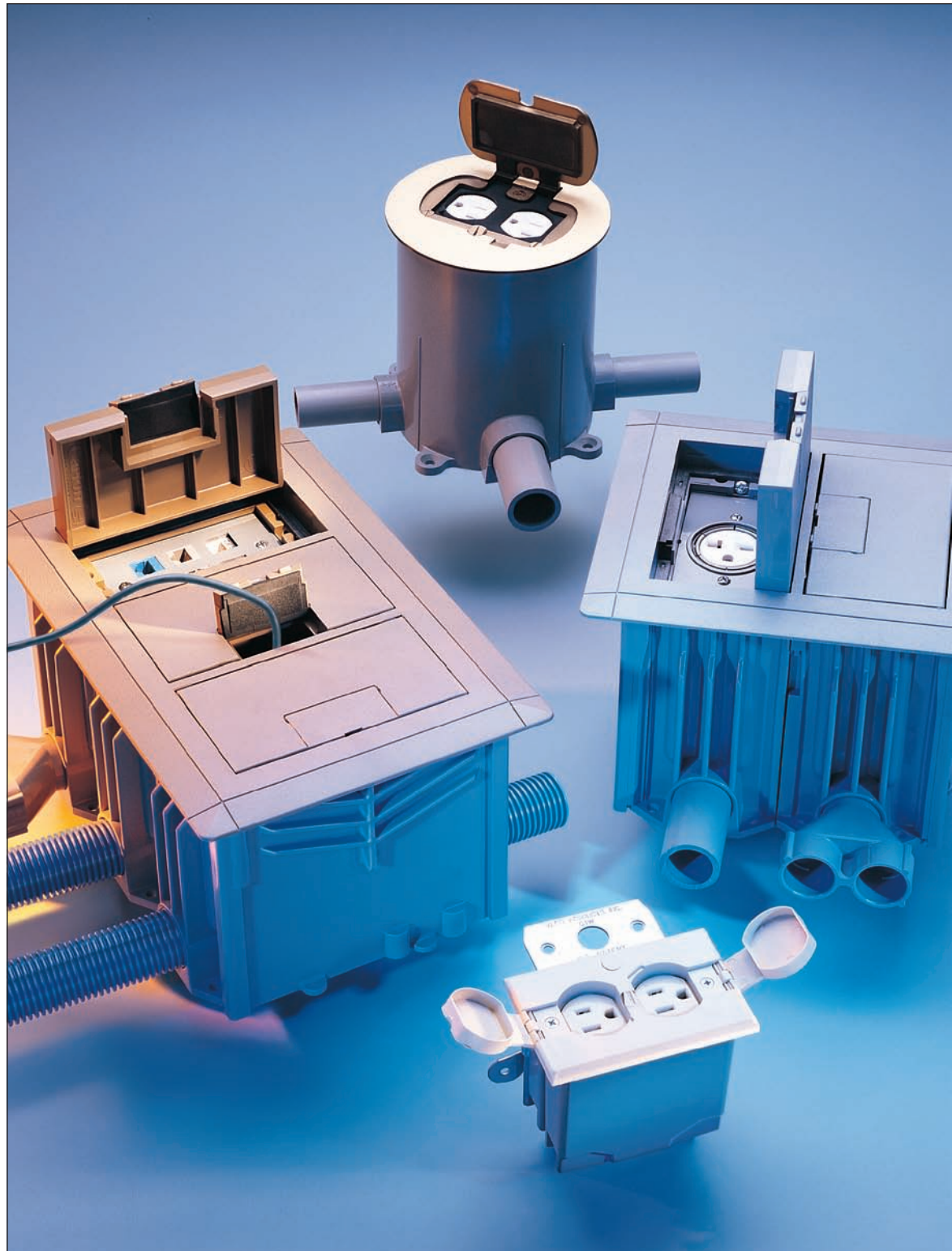



# Carlton® Floor Boxes and Covers

## Contents

### Adjust-A-Box® Residential Floor Boxes

1-, and 2-Gang Adjustable Residential Floor Boxes ..... 2 - 3

### Drop-In Floor Box

Drop-In Residential Floor Box ..... 4 - 5

### Rectangular Floor Boxes

1-, 2-, and 3-Gang ..... 6 - 7

Activation Kit..... 7

### Rectangular Floor Box Covers

1-, 2-, and 3-Gang Nonmetallic..... 8

1-, 2-, and 3-Gang Solid Brass ..... 9

### Round Floor Boxes

Nonmetallic Round Floor Boxes..... 10 - 11

Multi-Service Divider Kit..... 11

3/4" Y Fitting..... 11

Reducer Plugs..... 11

### Round Floor Box Covers

Round Floor Box Covers - Nonmetallic ..... 12

Brass Round Floor Box Covers ..... 13

# Adjust-A-Box® Residential Floor Boxes

## 1-, and 2-Gang Adjustable

**NEW!**



**Double-Gang,  
with Brass Cover**

*\*Devices not included*

\*U.S. Patent 5,289,934

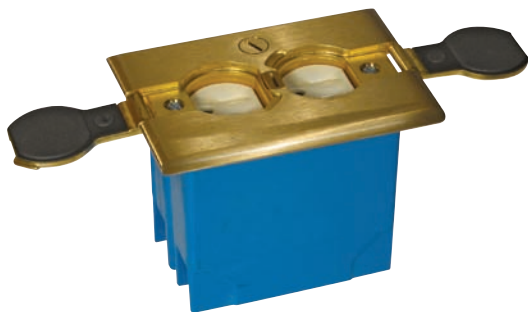

**Single-Gang,  
with Brass Cover**

Carlson Adjust-A-Box® Floor Boxes make installing floor outlets faster and easy by providing maximum installation flexibility. The box features a patented adjustment screw designed to adjust the box from 0" to 1-3/4" by simply turning the screw clockwise or counterclockwise, providing a flush mount every time.

Covers are able in two styles, nonmetallic and brass, and feature two hinged doors to protect unused devices, and keep out dust and scrubwater. Because the doors are attached, they won't get lost or misplaced while the outlet in use.

The Adjust-A-Box® is available in two sizes, single-gang and double-gang. The single-gang box has a 20 cubic inch capacity and includes a duplex receptacle, and the double-gang box has as 34 cubic inch capacity, and comes with a divider for dual voltage capabilities.

Carlson Adjust-A-Box® Residential Floor Boxes are ideal for residential and home office applications and provide a clean, aesthetically pleasing floor outlet anywhere you need it.

## Features

- Patented adjustment screw that adjusts depth (from 0" to 1 3/4")
- Available with nonmetallic and brass covers
- Covers have two (non-removable) hinged doors
- Solid brushed brass covers with a light lacquer finish for extra protection
- Nonmetallic covers are available in white and ivory
- Two-Gang version features dual service capabilities (requires use of dual service divider)
- Integral cable clamps
- Ideal for new work and retrofit applications
- UL listed
- UL scrub water tested
- 2 hour fire classification

# Adjust-A-Box® Residential Floor Boxes

## Installation

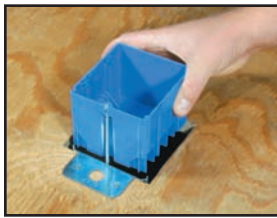

Install clip over subfloor.

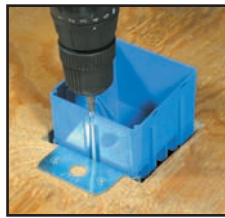

Screw in to adjust to height of flooring or carpet

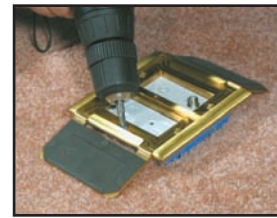

Beautiful flush fit every time!

## Specifications



Part Number	Size	Description	Cubic In.	Std. Ctn. Qty.	Std. Ctn. Wt. (lbs.)
B121BFBRW	One-Gang	Residential Floor Box w/ Nonmetallic White Cover	20	8	7.02
B121BFBR	One-Gang	Residential Floor Box w/ Nonmetallic Ivory Cover	20	8	7.02
B121BFBB	One-Gang	Residential Floor Box w/ Brass Cover	20	8	14.50
B234BFBB	Two-Gang	Two-Gang Residential Floor Box w/ Brass Cover	34	4	9.976

### Kits include:

#### Single-Gang

##### Ivory/White Cover:

- Two (2) 6-32x1 flat head machine screws
- Four (4) #6 1-1/4 self-tapping flat head screws
- Two (2) #6 1-5/8 drywall screws
- One (1) cover plug
- One (1) New Work Bracket
- One (1) Old Work Bracket
- One (1) 20 cubic in. UL Listed Floor Box
- One (1) UL Listed Brass Floor Cover
- One (1) short shank receptacle
- One (1) tube Dow Corning #4 sealant
- Installation instructions

##### Brass Cover:

- Two (2) 6-32x1 brass plated flat head machine screws
- Four (4) #6 1-1/4 self-tapping flat head screws
- Two (2) #6 1-5/8 drywall screws
- One (1) New Work Bracket
- One (1) Old Work Bracket
- One (1) 20 cubic in. UL Listed Floor Box
- One (1) UL Listed Brass Floor Cover
- One (1) short shank receptacle
- Green ground wire
- Installation instructions



#### Double-Gang

- One (1) New Work Bracket
- One (1) Old Work Bracket
- One (1) 34 cubic in. UL Listed Floor Box
- One (1) Dual Voltage Divider
- One (1) UL Listed Brass Floor Cover
- Four (4) #6-32x1" flat head machine screws
- Four (4) #6 x1-1/4" flat head self-tapping screws
- Two (2) #6x1-5/8" square drive trim head screws
- Green ground wire
- Installation instructions



\*Devices not included

# Drop-In Floor Box

**NEW!**



The Carlon Drop-In Floor Box with Brass Cover combines many of the same features in our existing Floor Box line with the strength, durability and style necessary to accommodate today's residential electrical/telecommunication needs.

The Carlon Drop-In Floor Box is the fastest easiest way for contractors to put a floor socket anywhere they need it! It's designed to accommodate high and low voltage applications and comes complete with everything needed for installation - *Floor box, Brass Cover, hole saw, wired receptacle, two-hole low voltage plate, blank plate, mounting screws, and wire nuts.*

**Note: The Drop-In Floor Box is available with or without a hole saw.**

## Features

- Single hole installation
- Fast, easy installation
- Solid brass cover has a light lacquer finish to resist wear - Ideal for high traffic areas
- Accommodates high and low voltage applications
- Includes single gang grounded receptacle, low voltage telephone/cable plate (data jacks not included), and blank plate for custom installations
- Available with or without a hole saw
- 11.8 inch cubic capacity
- For wood floor installations
- Ideal for residential and home offices
- Eliminates the need for extension cords
- Superior aesthetics - Ideal for home offices and entertainment rooms
- C-UL-US Listed Nonmetallic Outlet Box 655A

# Drop-In Floor Box



## Installation



**1.** Cut 2-3/8" hole through carpeting before using hole saw.



**2.** Drill hole in floor using hole saw.



**3.** Pull romex through floor.

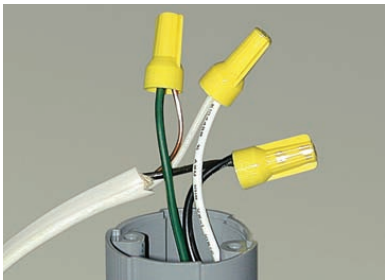

**4.** Connect receptacle wires to romex. Be sure to match wire color(s).



**5.** Secure wire clamp on bottom of tube.



**6.** Brass cover snaps into place. Use a small screwdriver to pry open brass cover to plug in appliance.

## Installed

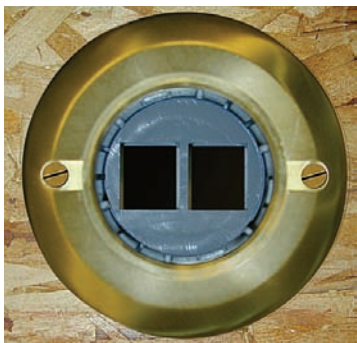

## Specifications

Part Number	UPC Code	Description	Std. Carton Qty.	Std. Carton Wt. (lbs.)
E971FBDI	034481186601	Drop-In Floor Box w/Hole Saw	5	6.5
E971FBDIB	034481189459	Drop-In Floor Box without Hole Saw	20	17.6

# Rectangular Floor Boxes

## 1-, 2-, and 3-Gang

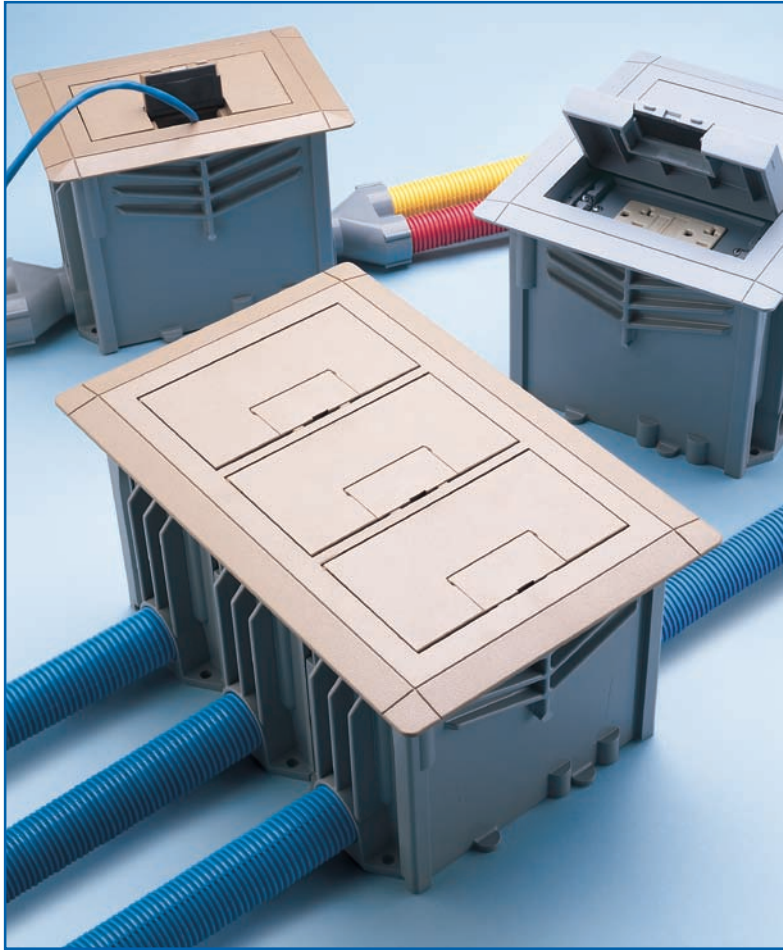

***Carlon® Rectangular Floor Box Systems – three-way power, data, and communications plus easy double or triple ganging, too.***

Compared to metal boxes, Carlon rectangular floor boxes cost less and install faster to save you money on every job. Three-in-one power, data, and communications capability cuts installation time and cost even more, while simple two- and three-gang modularity gives you the flexibility, installation ease, and cost-savings no other nonmetallic boxes can match. The covers attach without the use of fasteners, providing a professional, clean installation as well as preserving the aesthetic life of the product. Take a closer look at all our rectangular floor box systems offer you.

\*U.S. Patent 5,866,845

## Features

- Covers require no adjusting collar. Two screws assure a flush, secure installation.
- Nonmetallic PVC construction, watertight gasket, and corrosion-resistant hardware assure long life and reliable performance even in harsh and/or corrosive environments.
- One consistent box depth simplifies ordering time and reduces inventory.
- Saves time and money on installations with simple saw cut to floor level.
- Concrete tight and suitable for any on grade/ below grade application; concrete or wood sub-floor construction approved.
- Convenient cubic inch capacity markings on inside allow for easy inspection.
- PVC molded ports and reducer plugs included.
- Accepts 1/2", 3/4", and 1" conduit, tubing or raceway.
- Rectangular sides are drillable.
- For tile and carpet applications.
- Cover options include solid brass or thermoplastic (brown, slate, and caramel).
- UL scrub water tested.



# Rectangular Floor Boxes



## Installation

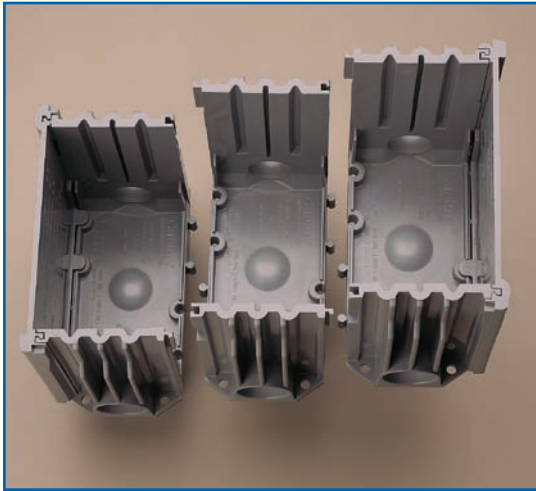

With our rectangular boxes, one SKU is all you ever need. Simply remove appropriate sides and slide boxes together to create two- or three-gang boxes for on-the-job flexibility no competitor offers.

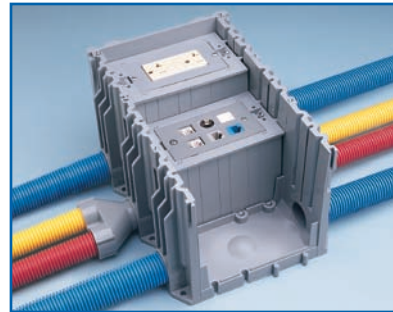
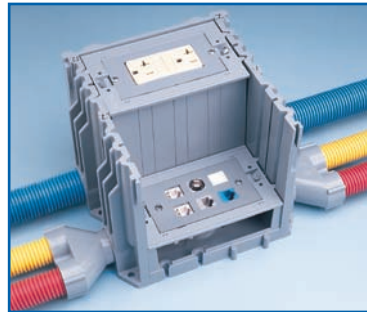

## Specifications

### Rectangular Floor Box

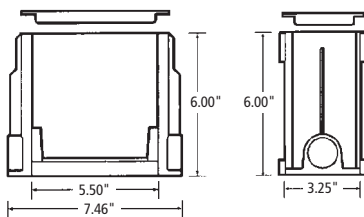

Part No.	Material	Size	Internal Volume (cu. in.)	Min. Concrete Depth	Hubs	Reducer Plugs	Std. Ctn. Qty.	Std. Ctn. Wt. lbs.
E976RFB	PVC	1-Gang	97.4 (16.8 per inch of Depth)	3 1/2"	(2) 1"	(2) 1" x 3/4" (2) 3/4" x 1/2"	3	6.92

### Activation Kit



Activation kit provides components to accommodate all standard power, data, and communications devices plus a divider to separate power from data and communications – all in a single SKU. Device yokes can be adjusted to store excess cord in the box.

Part No.	Material	Std. Ctn. Qty.	Std. Ctn. Wt. (lbs.)
E976AK2	PVC	3	2.47

# Rectangular Floor Box Covers – Nonmetallic



## 1-, 2-, and 3-Gang Nonmetallic

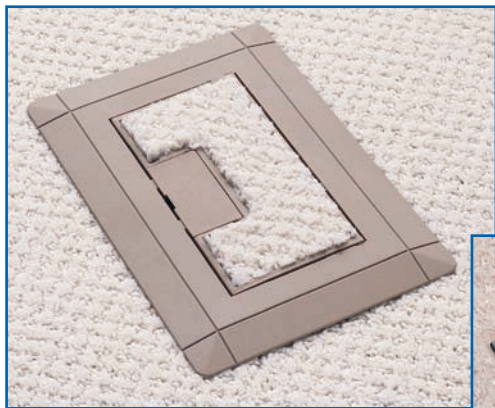

\*U.S. Patent 5,866,845

On-the-job flexibility extends to our rectangular box covers. Each one-, two-, or three-gang cover is suitable for any wiring application and can be used with any floor surface. Nonmetallic covers are even field reversible for tile or carpet. Double door feature allows easy access to the device and helps keep stray cords organized.

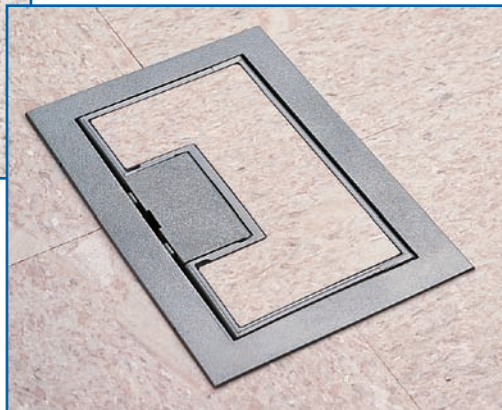

*Carlton Rectangular Floor box covers do not require a separate carpet flange. The carpet flange is part of the cover and may be removed for tile application.*

## Features

- High impact resistant thermoplastic
- Field reversible for tile or carpet
- Gasketed for a watertight seal
- Double door design
- For tile and carpet applications
- UL scrub water tested

## Specifications

### Rectangular Floor Box Covers – Nonmetallic

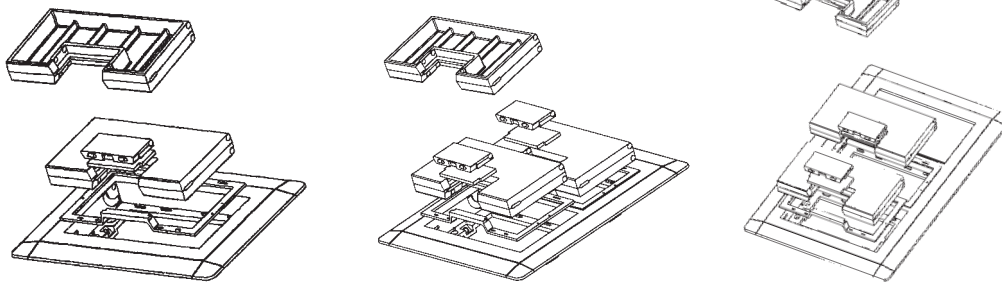

Part No.	Description	Dimensions (W x L)	Std. Ctn. Qty.	Std. Ctn. Wt. (lbs.)
E9761B	Brown Single-Gang Cover/Carpet Flange	7.13" x 5.00"	3	1.7
E9762B	Brown Double-Gang Cover/Carpet Flange	7.13" x 8.25"	9	8.5
E9763B	Brown Triple-Gang Cover/Carpet Flange	7.13" x 11.50"	6	7.5
E9761C	Caramel Single-Gang Cover/Carpet Flange	7.13" x 5.00"	3	1.7
E9762C	Caramel Double-Gang Cover/Carpet Flange	7.13" x 8.25"	9	8.5
E9763C	Caramel Triple-Gang Cover/Carpet Flange	7.13" x 11.50"	6	7.5
E9761S	Slate Single-Gang Cover/Carpet Flange	7.13" x 5.00"	3	1.7
E9762S	Slate Double-Gang Cover/Carpet Flange	7.13" x 8.25"	9	8.5
E9763S	Slate Triple-Gang Cover/Carpet Flange	7.13" x 11.50"	6	7.5

# Rectangular Floor Box Covers – Brass



## 1-, 2-, and 3-Gang Solid Brass

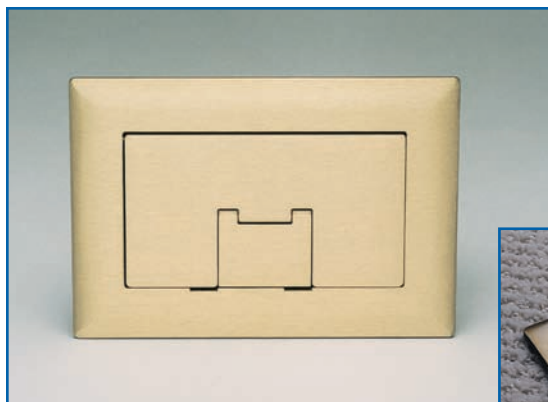

\*U.S. Patent 6,265,662

Carlton® Brass rectangular Floor Box Covers add a classic touch to all floor box installations and are particularly suited for use in high-traffic areas because of the resistance to wear. The gasket gives a watertight seal, and the light lacquer finish provides extra protection.



## Features

- Rugged solid brass construction.
- Brushed finish coated with a light lacquer for protection.
- Rectangular brass covers include a cord door.
- Gasketed for watertight applications.
- Rectangular brass covers allow for single, duplex, GFCI receptacles, and low voltage.
- For tile and carpet applications.
- UL scrub water tested.

## Specifications

### Rectangular Floor Box Covers – Brass

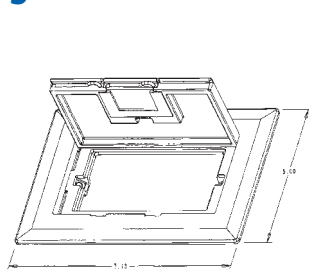

**E9761BR**

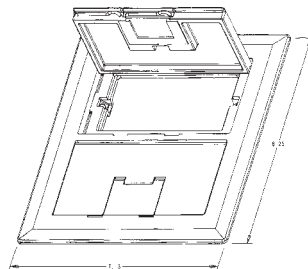

**E9762BR**

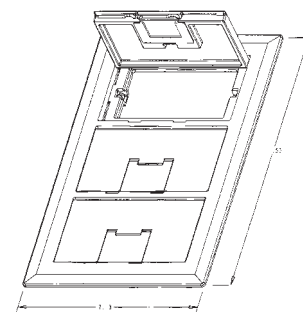

**E9763BR**

Part No.	Description	Std. Ctn. Qty.	Std. Ctn. Wt. (lbs.)
E9761BR	Brass Single-Gang Cover	3	6.8
E9762BR	Brass Double-Gang Cover	3	9.9
E9763BR	Brass Triple-Gang Cover	3	12.1
E976AK2	Rectangular Floor Box Activation Kit	3	1.3

# Round Floor Boxes

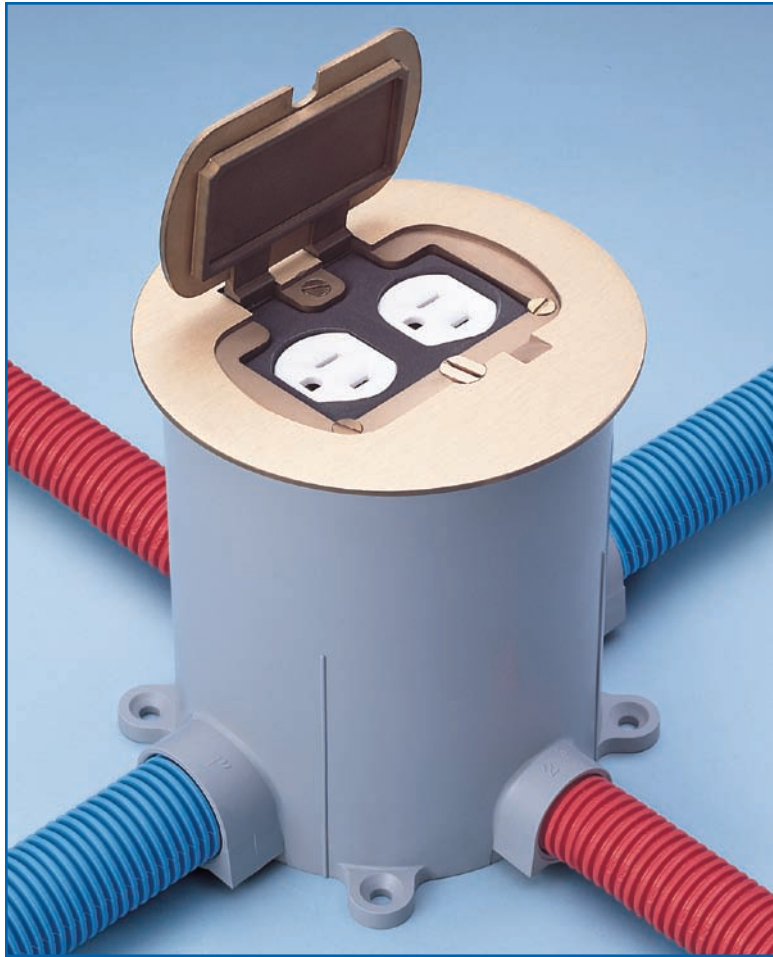

***Carlon® Round Floor Box Systems – three-way versatility for power, data, and communications.***

Carlon round floor boxes give you the same cost-saving advantages over metal boxes as our rectangular boxes. By letting you combine power, data, and communications in the same box, you can dramatically reduce your installation time and cost compared to other nonmetallic boxes. In addition, multi-use covers mean fewer SKUs to deal with and greater jobsite flexibility to increase your savings further. Take a closer look at all their advantages for yourself.

## Features

- Nonmetallic PVC construction, watertight gasket, and corrosion-resistant hardware assure long life and reliable performance even in harsh and/or corrosive environments.
- Brass and an assortment of nonmetallic covers are available for a variety of applications.
- The same box depth simplifies ordering and reduces inventory.
- For tile and carpet applications.
- Concrete tight and suitable for any on grade/below grade application; concrete or wood floor construction approved.
- Y-connector (E972Y) allows you to feed parallel runs of 3/4" conduit or to feed in/out from the same side for increased wiring flexibility and faster installation.
- PVC molded ports and reducer plugs included.
- Accepts 1/2", 3/4", and 1" conduit, tubing or raceway.
- UL scrub water tested.

## Specifications

### Round Floor Box

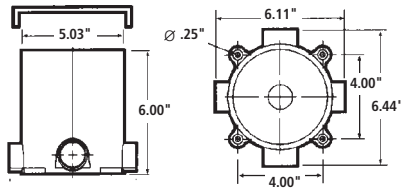

Carlson Round Floor Boxes allow for various thickness of concrete pours. Trim out is easy – just use a handsaw to cut off box at desired height to accommodate carpet, tile, or other flooring. Carlson leveling ring guarantees a level top every time, even if the box is tipped slightly during the pouring process.

Part No.	Internal Volume (cu. in.)	Min. Concrete Depth	Hubs	Reducer Plugs	Std. Ctn. Qty.	Std. Ctn. Wt. lbs.
◆ E971FB	90.0 (15.5 per inch of Depth)	3"	(2) 1" and (2) 3/4"	(2) 1" x 3/4" and (2) 3/4" x 1/2"	10	15.6

## Accessories

### Multi-Service Divider Kit



Multi-service divider kit for separate power, data, and communications compartments provides unbeatable flexibility and money-saving installation speed. For use with nonmetallic boxes only.

Part No.	Std. Ctn. Qty.	Std. Ctn. Wt. (lbs.)
◆ E973K	10	3

### 3/4" Y Fitting



The 3/4" Y Fitting provides for in and out service from a single 1" port, and allows for two 3/4" parallel conduit runs to adapt into a single conduit body port.

Part No.	Std. Ctn. Qty.	Std. Ctn. Wt. (lbs.)
E972Y	10	2.1

### Reducer Plugs

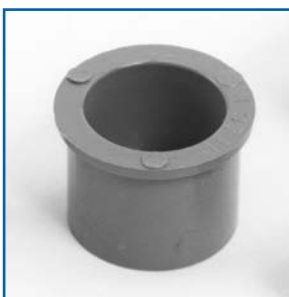

Part No.	Size	Std. Ctn. Qty.	Std. Ctn. Wt. (lbs.)
E971C	3/4" x 1/2"	100	2.1
E971D	1" x 3/4"	100	3.2

# Round Floor Box Covers – Nonmetallic



## Nonmetallic Covers

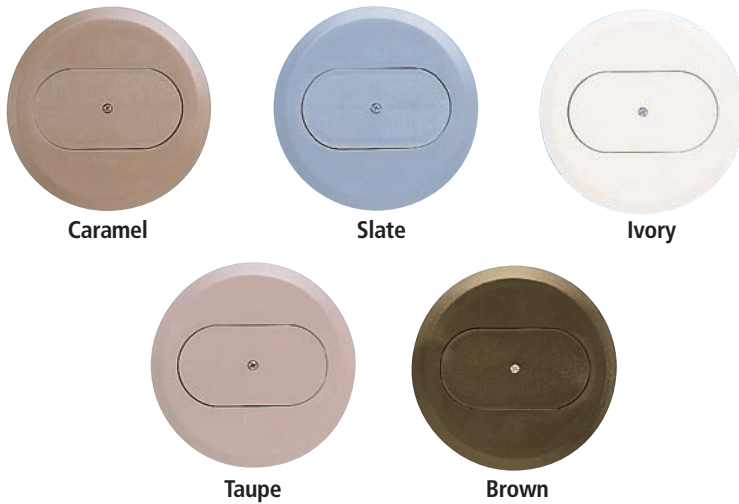

Caramel

Slate

Ivory

Taupe

Brown

U.S. Patent 6,450,353

## Features

- High impact resistant thermoplastic
- Compatible with standard NEMA Duplex, and 1 1/4" NPS receptacles
- Drill points (3/8") provided for low voltage cable pass throughs
- 1 1/4" NPS plugs may be modified to accept smaller fittings (3/8", 1/2", and 3/4")
- For tile and carpet applications
- UL scrub water tested

## Duplex Covers



Part No.	Color	Description	Std. Ctn. Qty.	Std. Ctn. Wt. (lbs.)
E97DSI	Ivory	Duplex Cover	10	5.2
E97DSC	Caramel	Duplex Cover	10	5.7
E97DST	Taupe	Duplex Cover	10	5.7
E97DSS	Slate	Duplex Cover	10	5.6
E97DSB	Brown	Duplex Cover	10	5.8

## 1 1/4" NPS Covers



Part No.	Color	Description	Std. Ctn. Qty.	Std. Ctn. Wt. (lbs.)
E97SSRB	Brown	NPS Cover	10	3.8
E97SSRC	Caramel	NPS Cover	10	3.8
E97SSRS	Slate	NPS Cover	10	3.8

## Metal Cover Adapter Ring



Part No.	Devices	Std. Ctn. Qty.	Std. Ctn. Wt. (lbs.)
E97ABR2	One-Piece Metal Cover Adapter	10	3.3

## Clear Cover Carpet Ring

Part No.	Color	Std. Ctn. Qty.	Std. Ctn. Wt. (lbs.)
E97CCR	Clear	10	1.2

# Round Floor Box Covers – Brass



## Brass Covers

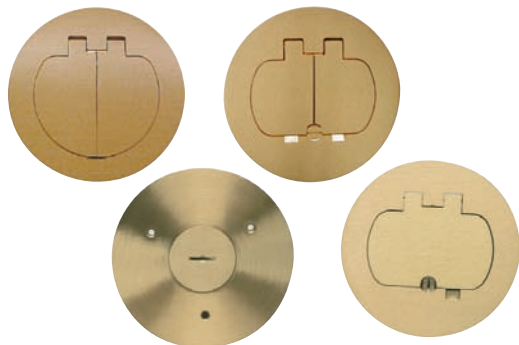

U.S. Patent 6,179,634

## Features

- Screws concealed under doors
- Rugged solid brass construction
- Brushed finish coated with a light lacquer for protection
- Resistance to wear – suited for high traffic areas
- Gasketed for watertight applications
- Available in four styles – Single Door, Two Door, NPS Opening, and Two Door Dual Service
- For tile and carpet applications
- UL scrub water tested

### Two Door Dual Service (Divider Kit included)

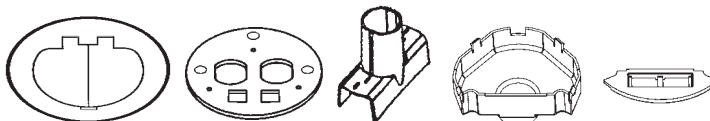

Part No.	Devices	Std. Ctn. Qty.	Std. Ctn. Wt. (lbs.)
E97BR2D	Duplex and Two Data Ports	5	9.2

### Two Door

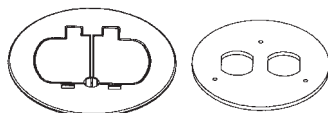

Part No.	Devices	Std. Ctn. Qty.	Std. Ctn. Wt. (lbs.)
E97BR2	Duplex	5	7

### Single Door

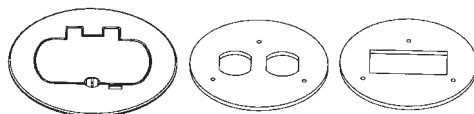
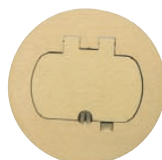

Part No.	Devices	Std. Ctn. Qty.	Std. Ctn. Wt. (lbs.)
E97BR	GFCI and Duplex	5	7

### NPS Opening

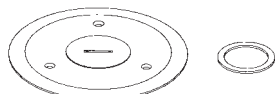

Part No.	Devices	Std. Ctn. Qty.	Std. Ctn. Wt. (lbs.)
E97BRG	1 1/4" Outlet and Single Receptacle	5	7.5

### ONE-YEAR LIMITED WARRANTY

The following are the only warranties made by Carlon®. Carlon warrants this product to be free from defects in materials and workmanship for a period of one year from date of purchase. In the event of a product failure, Carlon's liability, whether based on contract, tort, strict liability, warranty or any other claim, will be limited to the replacement of the product or refund of the purchase price which shall be in lieu of all other express or implied warranties, statutory or otherwise, including warranties of merchantability and fitness for use.

CARLON SHALL NOT BE LIABLE FOR LOST PROFITS, INDIRECT SPECIAL, EXEMPLARY, INCIDENTAL OR CONSEQUENTIAL DAMAGES INCLUDING WITHOUT LIMITATION ANY SUCH DAMAGE DUE TO IMPROPER WIRING OR MISUSE OF THE PRODUCT.

---

**Carlon®**  
LAMSON & SESSIONS

In USA, contact:  
25701 Science Park Drive • Cleveland, Ohio 44122  
1-800-3-CARLON (1-800-322-7566) • In Ohio, (216) 464-3400  
Fax: (216) 766-6444  
TDD/Hearing Impaired Access (216) 831-5918  
[www.carlon.com](http://www.carlon.com)

In Canada, contact:  
Lamson & Sessions Ltd.  
121 Watline Avenue  
Mississauga, ON • Canada L4Z 1P2  
(905) 755-1262 • (888) 269-9902  
Fax: (905) 755-1265 • (888) 269-8622