

TH 880204691

Das Urheberrecht an dieser Zeichnung und allen Beilagen, die dem Empfänger persönlich anvertraut sind, verbleibt jederzeit unserer Firma. Ohne unsere schriftliche Genehmigung dürfen sie nicht kopiert, auch niemals dritten Personen mitgeteilt oder zugänglich gemacht werden.

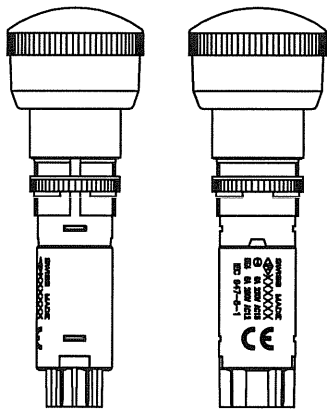
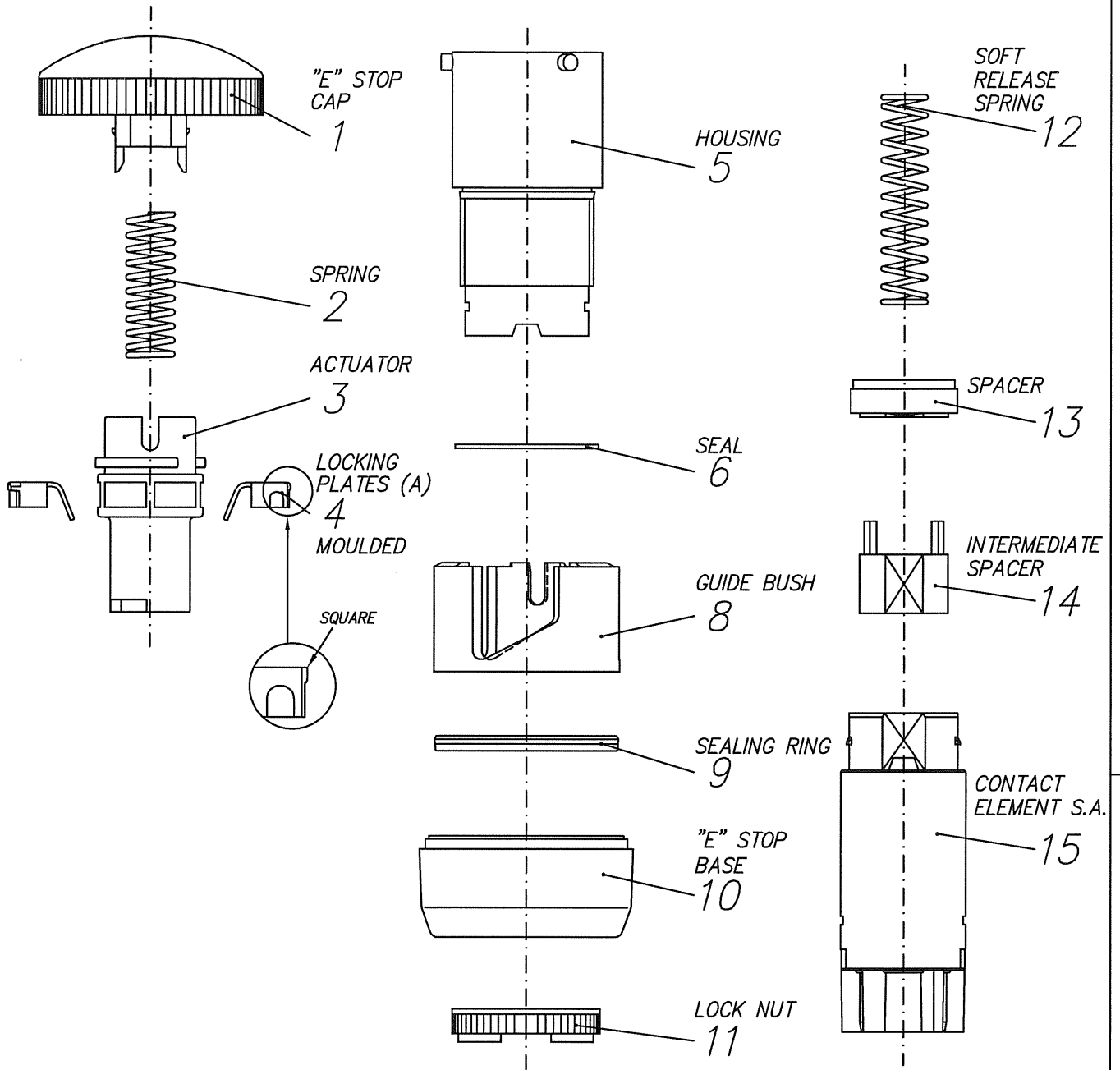

Actual size

NOT-AUS Tasten mit Laufnr. 000.

Beim Bedrücken muss die Verdrehungsschutz-Nut vom Frontgehäuse auf der bezeichneten Stelle sein.

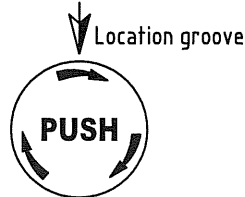

NOT-AUS Tasten mit Laufnr. 090.

Beim Bedrücken muss die Verdrehungsschutz-Nut vom Frontgehäuse auf der bezeichneten Stelle sein.

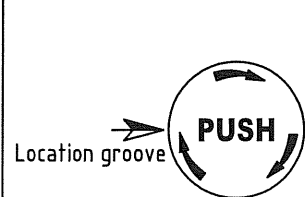

Aenderungen		Datum/visum	Mstb. 2:1 (1:1)	EMERGENCY STOP EN 418
1	Kragen 061302 neu	11.07.01 HP	Gez. 21.04.98 rw	IP67
2	Component description added	31.01.03 T.B.	Gep.	ROTARY RESET
3			th contact ag	28-80203-000
4			CH-4153 Reinach	th8
5				

Emergency stop switches according to EN 418 IP66/IP67

Panel cut-out 16.2 mm

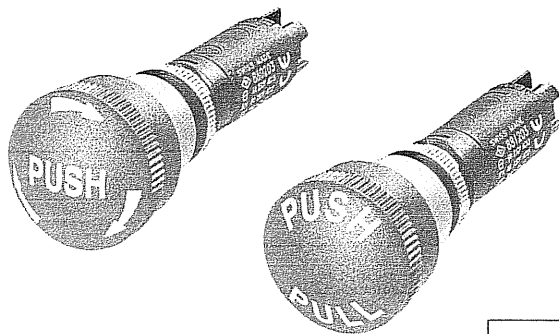

- mushroom cap Ø 27 mm, red
- meet EN 418 regulations (can not be defeated)
- approved by IEC 947-5-1/947-5-5
- rotary reset or pull reset
- faston terminals 2.8 x 0.5 mm

	rotary reset	pull reset
1NC+1NO	880 203 000	881 203 000
2NC	880 204 000	881 204 000

Accessories

Background disk Ø 43 mm x 5 mm for panel cut-out 16.2 mm	<ul style="list-style-type: none"> • yellow plastic • including seal <p>with printing 893 002 000</p> <p>without printing 893 003 000</p>	
Adapterset Ø 43 mm x 5 mm for panel cut-out 22.5 mm	<ul style="list-style-type: none"> • yellow plastic • including seal and washer <p>with printing 893 000 000</p> <p>without printing 893 001 000</p>	
Background decal Ø 43 mm x 0.1 mm for panel cut-out 16.2 mm	<ul style="list-style-type: none"> • self adhesive PVC-leaf, yellow <p>with printing 893 011 000</p> <p>without printing 893 010 000</p>	

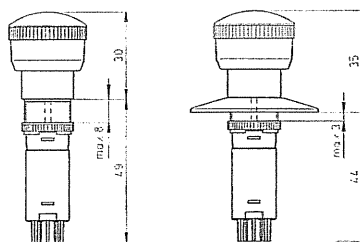

weight 16.8 g



Printing in further languages upon request

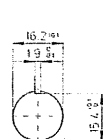

for back-ground decal
for panel cut-out
Ø 16.2 mm

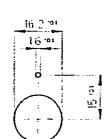

for back-ground disk
for panel cut-out
Ø 16.2 mm

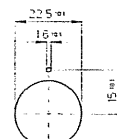

for adapter set
for panel cut-out
Ø 22.5 mm

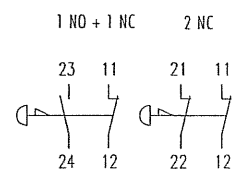



Technical Information

Actuating force	Approx. 6 N pushbutton switches Approx. 32 N emergency stop switches Approx. 25 N mushroom switches												
Fixation	Pushbutton switches: central, with metal fixation nut Emergency stop switches / mushroom switches: central, with metal fixation nut Mushroom switches with key reset: central, with anti-rotation device and metal fixation nut												
Protective system	Generally: IP66/IP67, exception: mushroom switch IP40 with key reset												
Bezel material	Thermoplast or nickel plated brass												
Lens material	Thermoplast (polycarbonate)												
Ambient temperature	-25° upto +55°C Heat congestion should be avoided												
Life expectancy mechanical operating cycles	<table border="0"> <tr> <td>Pushbutton switches:</td> <td>Mushroom switches:</td> <td>Emergency stop:</td> <td>Mushroom switch with key:</td> </tr> <tr> <td>1'000'000</td> <td>50'000</td> <td>30'000</td> <td>25'000</td> </tr> </table>	Pushbutton switches:	Mushroom switches:	Emergency stop:	Mushroom switch with key:	1'000'000	50'000	30'000	25'000				
Pushbutton switches:	Mushroom switches:	Emergency stop:	Mushroom switch with key:										
1'000'000	50'000	30'000	25'000										
Contact block 6A	factory fitted onto the switch												
Casing material	Thermoplast												
Terminal material	Silver nickel, 0.4 µm gold plated												
Contact resistance	< 30 mOhm												
Number of contacts	<table border="0"> <tr> <td>Pushbutton switches:</td> <td>Emergency stop switches and mushroom switches:</td> </tr> <tr> <td>1NC + 1NO</td> <td>1NC + 1NO</td> </tr> <tr> <td>2NC</td> <td>2NC</td> </tr> <tr> <td>2NO</td> <td></td> </tr> </table> <p>circuits independent of each other</p>	Pushbutton switches:	Emergency stop switches and mushroom switches:	1NC + 1NO	1NC + 1NO	2NC	2NC	2NO					
Pushbutton switches:	Emergency stop switches and mushroom switches:												
1NC + 1NO	1NC + 1NO												
2NC	2NC												
2NO													
Terminals	Faston terminals 2.8 x 0.5 mm for faston plugs according to DIN 46247 Please respect the installation regulations!												
Switching mechanism	<table border="0"> <tr> <td>Pushbutton switches: self cleaning snap-action contacts, bounce time < 1 msec</td> <td>Emergency stop and mushroom switches: self cleaning contacts with positive opening operation, bounce time < 1 msec</td> </tr> </table>	Pushbutton switches: self cleaning snap-action contacts, bounce time < 1 msec	Emergency stop and mushroom switches: self cleaning contacts with positive opening operation, bounce time < 1 msec										
Pushbutton switches: self cleaning snap-action contacts, bounce time < 1 msec	Emergency stop and mushroom switches: self cleaning contacts with positive opening operation, bounce time < 1 msec												
Contact gap	> 3 mm												
Switching capacity	6A, 230V AC utilization category AC-15 according to IEC 947-5-1, recommended miniature breaker type C 6A												
Life expectancy electrical	<table border="0"> <tr> <td>20'000 operating cycles</td> <td>50'000 operating cycles</td> <td>100'000 operating cycles</td> <td>300'000 operating cycles</td> </tr> <tr> <td>-</td> <td>6A 250V AC12</td> <td>-</td> <td>2.5A 250V AC12</td> </tr> <tr> <td>10A 24V DC13</td> <td>5A 24V DC13</td> <td>5A 12V DC13</td> <td>-</td> </tr> </table>	20'000 operating cycles	50'000 operating cycles	100'000 operating cycles	300'000 operating cycles	-	6A 250V AC12	-	2.5A 250V AC12	10A 24V DC13	5A 24V DC13	5A 12V DC13	-
20'000 operating cycles	50'000 operating cycles	100'000 operating cycles	300'000 operating cycles										
-	6A 250V AC12	-	2.5A 250V AC12										
10A 24V DC13	5A 24V DC13	5A 12V DC13	-										