

PCA-6180

Full-size socket 370 Intel®
Pentium® III / Celeron®
processor based
PCI/ISA-bus CPU card

Copyright notice

This document is copyrighted, 2000, by Advantech Co., Ltd. All rights are reserved. Advantech Co., Ltd. reserves the right to make improvements to the products described in this manual at any time without notice.

No part of this manual may be reproduced, copied, translated or transmitted in any form or by any means without the prior written permission of Advantech Co., Ltd. Information provided in this manual is intended to be accurate and reliable. However, Advantech Co., Ltd. assumes no responsibility for its use, nor for any infringements upon the rights of third parties which may result from its use.

Acknowledgements

- AWARD is a trademark of AWARD Software, Inc.
- IBM and PC are trademarks of International Business Machines Corporation.
- Intel®, Pentium® III, and Celeron® are trademarks of Intel Corporation.
- MS-DOS is a trademark of Microsoft Corporation.
- SMC is a trademark of Standard Microsystems Corporation.
- WinBond is a trademark of Winbond Corporation.
- Adaptec is a registered trademark of Adaptec, Inc.

All other product names or trademarks are the properties of their respective owners.

A Message to the Customer

Advantech customer services

Each and every Advantech product is built to the most exacting specifications to ensure reliable performance in the harsh and demanding conditions typical of industrial environments. Whether your new Advantech equipment is destined for the laboratory or the factory floor, you can be assured that your product will provide the reliability and ease of operation for which the name Advantech has come to be known.

Your satisfaction is our primary concern. Here is a guide to Advantech's customer services. To ensure you get the full benefit of our services, please follow the instructions below carefully.

Technical support

We want you to get the maximum performance from your products. So if you run into technical difficulties, we are here to help. For the most frequently asked questions, you can easily find answers in your product documentation. These answers are normally a lot more detailed than the ones we can give over the phone.

So please consult this manual first. If you still cannot find the answer, gather all the information or questions that apply to your problem, and with the product close at hand, call your dealer. Our dealers are well trained and ready to give you the support you need to get the most from your Advantech products. In fact, most problems reported are minor and are able to be easily solved over the phone.

In addition, free technical support is available from Advantech engineers every business day. We are always ready to give advice on application requirements or specific information on the installation and operation of any of our products.

PCA-6180 Series comparison table

Model	PCA-6180E	PCA-6180E2	PCA-6180SE	PCA-6180F
CPU: Intel® Pentium® III / Celeron® socket 370	v	v	v	v
System chipset: Intel® 815E	v	v	v	v
BIOS: Award P&P BIOS	v	v	v	v
Max. system RAM: 512MB	v	v	v	v
ISA High Drive	v	v	v	v
4 USB Ports	4	4	4	4
2 EIDE connectors	v	v	v	v
2 serial, 1 parallel ports	v	v	v	v
Chipset integrated VGA (AGP)	v	v	v	v
LAN: 10/100Base-T Ethernet	SINGLE	DUAL	SINGLE	DUAL
SCSI: 32-bit PCI Ultra 160 SCSI (Adaptec AIC-7892 chipset)	—	—	v	v

Product warranty

Advantech warrants to you, the original purchaser, that each of its products will be free from defects in materials and workmanship for two years from the date of purchase.

This warranty does not apply to any products which have been repaired or altered by persons other than repair personnel authorized by Advantech, or which have been subject to misuse, abuse, accident or improper installation. Advantech assumes no liability under the terms of this warranty as a consequence of such events.

If an Advantech product is defective, it will be repaired or replaced at no charge during the warranty period. For out-of-warranty repairs, you will be billed according to the cost of replacement materials, service time and freight. Please consult your dealer for more details.

If you think you have a defective product, follow these steps:

1. Collect all the information about the problem encountered. (For example, type of PC, CPU speed, Advantech products used, other hardware and software used, etc.) Note anything abnormal and list any on-screen messages you get when the problem occurs.
2. Call your dealer and describe the problem. Please have your manual, product, and any helpful information readily available.
3. If your product is diagnosed as defective, obtain an RMA (return material authorization) number from your dealer. This allows us to process your return more quickly.
4. Carefully pack the defective product, a fully-completed Repair and Replacement Order Card and a photocopy proof of purchase date (such as your sales receipt) in a shippable container. A product returned without proof of the purchase date is not eligible for warranty service.
5. Write the RMA number visibly on the outside of the package and ship it prepaid to your dealer.

Initial Inspection

Before you begin installing your card, please make sure that the following materials have been shipped:

- 1 PCA-6180 socket 370 Pentium® III / Celeron® processor-based single board computer
- 1 PCA-6180 Startup Manual
- 1 CD with driver utility and manual (in PDF format)
- 2 SCSI driver disks (optional)
- 1 FDD cable
- 2 Ultra ATA 100 HDD cables, P/N: 1701400452
- 1 printer (parallel port) cable & COM port cable kit, P/N: 1700060305
- 1 ATX-to-PS/2 power cable, P/N: 1700000450
- 1 ivory cable for PS/2 keyboard and PS/2 mouse, P/N: 1700060202
- 1 single-slot bracket, P/N: 1962159010
- 1 USB cable adapter (optional), P/N: 1700100170

If any of these items are missing or damaged, contact your distributor or sales representative immediately.

We have carefully inspected the PCA-6180 mechanically and electrically before shipment. It should be free of marks and scratches and in perfect working order upon receipt.

As you unpack the PCA-6180, check it for signs of shipping damage. (For example, damaged box, scratches, dents, etc.) If it is damaged or it fails to meet the specifications, notify our service department or your local sales representative immediately. Also notify the carrier. Retain the shipping carton and packing material for inspection by the carrier. After inspection, we will make arrangements to repair or replace the unit.

Contents

Chapter 1 Hardware Configuration	1
1.1 Introduction	2
1.2 Features	3
1.3 Specifications	5
1.3.1 System	5
1.3.2 Memory	5
1.3.3 Input/Output	5
1.3.4 VGA interface	6
1.3.5 SCSI interface	6
1.3.6 Ethernet LAN	6
1.3.7 Industrial features	6
1.3.8 Mechanical and environmental specifications	6
1.4 Board Layout: Main Features	8
1.5 Jumpers and Connectors	9
1.6 Location of Jumpers and Connectors	12
1.7 Safety Precautions	13
1.8 Jumper Settings	14
1.8.1 How to set the jumpers	14
1.8.2 CMOS clear (J1)	14
1.8.3 Watchdog timer output (J2)	15
1.9 System Memory	16
1.9.1 Sample calculation: DIMM memory capacity	16
1.9.2 Supplementary information about DIMMs	17
1.10 Memory Installation Procedures	18
1.11 Cache Memory	18
1.12 CPU Installation	19
Chapter 2 Connecting Peripherals	21
2.1 Introduction	22
2.2 Primary (CN1) and Secondary (CN2) IDE Connectors	22
2.3 Floppy Drive Connector (CN3)	23

2.4	Parallel Port (CN4)	23
2.5	SCSI Connector (CN5)	24
2.6	USB Ports (CN31 and CN32)	25
2.7	VGA Connector (CN7)	25
2.8	10/100Base-T Ethernet Connectors (CN8 and CN34)	26
2.9	Serial Ports (CN9: COM1; CN10: COM2)	26
2.10	PS/2 Keyboard and Mouse Connectors (CN11 and CN33)	28
2.11	External Keyboard Connector (CN12)	28
2.12	Infrared (IR) Connector (CN13)	29
2.13	CPU Fan Connector (CN14)	29
2.14	Front Panel Connectors (CN16, CN17, CN18, CN19, CN21 and CN22)	30
	2.14.1 Keyboard lock and power LED (CN16)	30
	2.14.2 External speaker (CN17)	30
	2.14.3 Reset (CN18)	30
	2.14.4 HDD LED (CN19)	31
	2.14.5 ATX soft power switch (CN21)	31
2.15	ATX Power Control Connectors (CN20 and CN21)	31
	2.15.1 ATX feature connector (CN20) and soft power switch connector (CN21)	31
	2.15.2 Controlling the soft power switch	32
2.16	SM Bus Connector (CN23)	32
Chapter 3 Award BIOS Setup		33
3.1	Introduction	34
3.2	Entering Setup	34
3.3	Standard CMOS Setup	35
	3.3.1 CMOS RAM backup	35
3.4	Advanced BIOS Features	36
	3.4.1 Virus Warning	36
	3.4.2 CPU Internal Cache / External Cache	36
	3.4.3 CPU L2 Cache ECC Checking	37
	3.4.4 Quick Power On Self Test	37
	3.4.5 First/Second/Third/Other Boot Device	37

3.4.6	Swap Floppy Drive	37
3.4.7	Boot UP Floppy Seek	37
3.4.8	Boot Up NumLock	37
3.4.9	Gate A20 Option	38
3.4.10	Typematic Rate Setting	38
3.4.11	Typematic Rate (Chars/Sec)	38
3.4.12	Typematic Delay (msec)	38
3.4.13	Security Option	38
3.4.14	OS Select for DRAM > 64MB	39
3.4.15	Report No FDD For Win 95	39
3.5	Advanced Chipset Features	39
3.5.1	SDRAM CAS Latency Time	40
3.5.2	SDRAM Cycle Time Tras/Trc	40
3.5.3	SDRAM RAS-to-CAS Delay	40
3.5.4	SDRAM RAS Precharge Time	40
3.5.5	System BIOS Cacheable	41
3.5.6	Video Bios Cacheable	41
3.5.7	Memory Hole At 15M-16M	41
3.5.8	CPU Latency Timer	41
3.5.9	Delayed Transaction	41
3.5.10	AGP Graphics Aperture Size (MB)	41
3.5.11	On-Chip Video Window Size	42
3.6	Integrated Peripherals	42
3.6.1	On-Chip Primary/Secondary PCI IDE	42
3.6.2	IDE Primary Master/Slave PIO/UDMA Mode, IDE Secondary Master/Slave PIO/UDMA Mode (Auto)	42
3.6.3	USB Controller	43
3.6.4	USB Keyboard Support	43
3.6.5	Init Display First	43
3.6.6	IDE HDD Block Mode	43
3.6.7	Onboard FDC Controller	43
3.6.8	Onboard Serial Port 1 (3F8H/IRQ4).....	43
3.6.9	Onboard Serial Port 2 (2F8H/IRQ3).....	43
3.6.10	UART Mode Select	44
3.6.11	RxD, TxD Active	44

3.6.12	IR Transmission Delay	44
3.6.13	UR2 Duplex Mode	44
3.6.14	Use IR Pins	45
3.6.15	Onboard Parallel Port (378H/IRQ7)	45
3.6.16	Parallel Port Mode (ECP + EPP)	45
3.6.17	EPP Mode Select	45
3.6.18	ECP Mode Use DMA	45
3.7	Power Management Setup	46
3.7.1	Power Management	46
3.7.2	HDD Power Down	46
3.7.3	Soft-Off by PWR-BTTN	46
3.7.4	PowerOn By LAN	47
3.7.5	PowerOn By Modem	47
3.7.6	PowerOn By Alarm	47
3.7.8	CPU Thermal-Throttling	47
3.8	PnP/PCI Configurations	47
3.8.1	Resources controlled by:	47
3.8.2	PnP OS Installed	47
3.8.3	Reset Configuration Data	48
3.8.4	PCI/VGA Palette Snoop	48
3.9	PC Health Status	48
3.9.1	CPU Warning Temperature	48
3.9.2	Current System Temp.	48
3.9.3	Current CPU Temperature	49
3.9.4	Current CPUFAN Speed	49
3.9.5	+5V/+12V/-12V/-5V	49
3.9.6	Shutdown Temperature	49
3.10	Load Setup Defaults	50
3.11	Password Setting	50
3.12	Save & Exit Setup	51
3.13	Exit Without Saving	51
Chapter 4 Chipset Software Installation (CSI) Utility .		53
4.1	Before You Begin	54
4.2	Introduction	54

4.3	Installing the CSI Utility	56
Chapter 5	AGP SVGA Setup	59
5.1	Introduction	60
5.2	Installation	60
Chapter 6	LAN Configuration	65
6.1	Introduction	66
6.2	Features	66
6.3	Installation	67
6.4	Windows 95/98/2000 Drivers Setup Procedure	68
6.5	Windows NT Drivers Setup Procedure	75
6.6	Windows 98SE/ME Drivers Setup Procedure	78
6.7	Windows NT Wake-on-LAN Setup Procedure	85
Chapter 7	Ultra ATA 100 Storage Driver Setup	87
7.1	Introduction	88
7.2	Features	88
7.3	Installation	89
7.4	Displaying Driver Information	93
Chapter 8	Onboard Security Setup	95
8.1	Introduction	96
8.2	Installation	96
8.3	Windows 9X Drivers Setup Procedure	97
8.4	Windows NT Drivers Setup Procedure	100
8.5	Using the OBS Hardware Doctor Utility	104
Appendix A	Programming the Watchdog Timer	107
A.1	Programming the Watchdog Timer	108
A.1.1	Watchdog timer overview	108
A.1.2	Reset/ Interrupt selection	108
A.1.3	Programming the Watchdog Timer	108
A.1.4	Example Program	111
Appendix B	Pin Assignments	117
B.1	IDE Hard Drive Connector (CN1, CN2)	118

B.2	Floppy Drive Connector (CN3)	119
B.3	Parallel Port Connector (CN4)	120
B.4	SCSI Connector (CN5)	121
B.5	USB Connector (CN6)	122
B.6	VGA Connector (CN7)	122
B.7	Ethernet 10/100Base-T RJ-45 Connector (CN8, CN34)	123
B.8	COM1/COM2 RS-232 Serial Port (CN9, CN10)	123
B.9	Keyboard and Mouse Connector (CN11)	124
B.10	External Keyboard Connector (CN12)	124
B.11	IR Connector (CN13)	125
B.12	CPU Fan Power Connector (CN14)	125
B.13	Power LED and Keylock Connector (CN16)	126
B.14	External Speaker Connector (CN17)	126
B.15	Reset Connector (CN18)	127
B.16	HDD LED Connector (CN19)	127
B.17	ATX Feature Connector (CN20)	127
B.18	ATX Soft Power Switch (CN21)	128
B.19	H/W Monitor Alarm (CN22)	128
B.20	SM Bus Connector (CN23)	128
B.21	Extension I/O Board Connector (CN27)	129
B.22	Extension I/O Board Connector (CN28)	129
B.23	PS/2 Mouse Connector (CN33)	130
B.24	System I/O Ports	131
B.25	DMA Channel Assignments	132
B.26	Interrupt Assignments	132
B.27	1st MB Memory Map	133
B.28	PCI Bus Map	133

Figures

Figure 1-1: Board layout: main features	8
Figure 1-2: Rear plate	9
Figure 1-3: Location of jumpers and connectors	12
Figure 3-1: Awards BIOS setup initial screen	34
Figure 3-2: Standard CMOS features screen	35
Figure 3-3: Awards BIOS features screen (1)	36
Figure 3-4: Awards BIOS features screen (2)	39
Figure 3-5: Advanced chipset features screen	40
Figure 3-6: Integrated peripherals (1)	42
Figure 3-7: Integrated peripherals (2)	44
Figure 3-8: Power management setup screen	46
Figure 3-9: PnP/PCI configurations screen	48
Figure 3-10: PC health status screen	49

Tables

Table 1-1: Jumpers	9
Table 1-2: Connectors	10
Table 1-3: CMOS clear (J1)	14
Table 1-4: Watchdog timer output (J2)	15
Table 1-5: DIMM module allocation table	16
Table 1-6: DIMM memory capacity sample calculation	16
Table 2-1: Serial port connections (COM1, COM2)	27
Table 2-2: PS/2 or ATX power supply LED status	30
Table A-1: Watchdog timer registers	110
Table B-1: IDE hard drive connector (CN1, CN2)	118
Table B-2: Floppy drive connector (CN3)	119
Table B-3: Parallel port connector (CN4)	120
Table B-4: SCSI connector (CN5)	121
Table B-5: USB1/USB2 connector (CN6)	122
Table B-6: VGA connector (CN7)	122
Table B-7: Ethernet 10/100Base-T RJ-45 connector (CN8, CN34)	123
Table B-8: COM1/COM2 RS-232 serial port (CN9, CN10)	123
Table B-9: Keyboard and mouse connector (CN11)	124
Table B-10: External keyboard connector (CN12)	124
Table B-11: IR connector (CN13)	125
Table B-12: CPU fan power connector (CN14)	125
Table B-13: Power LED and keylock connector (CN16)	126
Table B-14: External speaker (CN17)	126
Table B-15: Reset connector (CN18)	127
Table B-16: HDD LED connector (CN19)	127
Table B-17: ATX feature connector (CN20)	127
Table B-18: ATX soft power switch (CN21)	128
Table B-19: H/W monitor alarm (CN22)	128
Table B-20: ATX soft power switch (CN21)	128
Table B-21: Extension I/O board connector (CN27)	129
Table B-22: Extension I/O board connector (CN28)	129
Table B-23: PS/2 mouse connector (CN33)	130
Table B-24: System I/O ports	131
Table B-25: DMA channel assignments	132
Table B-26: Interrupt assignments	132
Table B-27: 1st MB memory map	133

CHAPTER 1

Hardware Configuration

This chapter gives background information on the PCA-6180. It then shows you how to configure the card to match your application and prepare it for installation into your PC.

Sections include:

- Introduction
- Features
- Specifications
- Board Layout
- Jumpers and Connectors
- Location of Jumpers and Connectors
- Safety Precautions
- Jumper Settings
- System Memory
- Memory Installation Procedures
- Cache Memory
- CPU Installation

1.1 Introduction

The PCA-6180 Series all-in-one industrial grade CPU card uses Intel®'s highly acclaimed Pentium® III / Celeron® processor, together with the Intel® 815E chipset. The card works with standard ISA- or PCI/ISA-bus passive backplanes.

The CPU provides 256/128 KB on-CPU L2 cache, eliminating the need for external SRAM chips. It has two PCI EIDE interfaces (for up to four devices) and a floppy disk drive interface (for up to two devices). Other features include two RS-232 serial ports (16C550 UARTs with 16-byte FIFO or compatible), one enhanced parallel port (supports SPP/EPP/ECP) and four USB (Universal Serial Bus) ports. The PCI enhanced IDE controller supports Ultra ATA/100/66/33 and PIO Mode 4 operation. This provides data transfer rates of 100/66/33 MB/sec. System BIOS supports boot-up from an IDE HDD/CD-ROM, SCSI HDD/CD-ROM, LS-120, ZIP-100, FDD, and LAN.

A backup of CMOS data is stored in the Flash memory, which protects data even after a battery failure. Also included is a 255-level watchdog timer, which resets the CPU or generates an interrupt if a program cannot be executed normally. This enables reliable operation in unattended environments.

The PCA-6180 Series offers several impressive industrial features such as a chipset integrated VGA (AGP) controller, a PCI Ultra 160 SCSI controller, dual 10/100Base-T networking controllers, three DIMM slots for a total of 512 MB SDRAM memory, and an ISA High Drive. All these make it an ideal choice for applications that require both high performance and full functionality.

Note: Some of the features mentioned above are not available with all models. For more information about the specifications of a particular model, see Section 1.3: Specifications.

1.2 Features

1. **Fan status monitoring and alarm:** To prevent system overheating and damage, the CPU fan can be monitored for speed and failure. The fan is set for its normal RPM range and alarm thresholds.
2. **Temperature monitoring and alert:** To prevent system overheating and damage, the CPU card supports processor thermal sensing and auto-protection.
3. **Voltage monitoring and alert:** System voltage levels are monitored to ensure stable current flows to critical components. Voltage specifications will become even more critical for processors of the future. Thus monitoring will become ever more necessary to ensure proper system configuration and management.
4. **ATX soft power switch:** Through the BIOS, the power button can be defined as the "Standby" (aka "Suspend" or "Sleep") button or as the "Soft-Off" button (see Section 3.6.6 Soft-off by PWR-BTN). Regardless of the setting, pushing the power button for more than 4 seconds will enter the Soft-Off mode.
5. **Power-on by modem (requires modem):** This allows a computer to be turned on remotely through an internal or external modem. Users can thus access information on their computers from anywhere in the world.
6. **Remote wake-up:** This feature (aka "Wake-on-LAN") allows you to remotely power up your system through your network by sending a wake-up frame or signal. With this feature, you can remotely upload/download data to/from systems during off-peak hours.
7. **Message LED:** Chassis LEDs now act as information providers. The way a particular LED illuminates indicates the stage the computer is in. A single glimpse provides useful information to the user.
8. **Jumperless mode:** When enabled, this allows changes of

processor settings and Vcore voltages all through the BIOS setup.

9. **CMOS RAM backup:** When BIOS CMOS setup has been completed, data in the CMOS RAM is automatically backed up to the Flash ROM. This is particularly useful in industrial environments which may cause soft errors. Upon such an error, BIOS will check the data and automatically restore the original data for rebooting.

10. **More:**

- Additional metal bracket for CPU stabilization
- **Power on by alarm:** Powers up your computer at a certain time
- **Virus warning:** During and after system boot-up, any attempt to write to the boot sector or partition table of the hard disk drive will halt the system. In this case, a warning message will be displayed. You can then run your anti-virus program to locate the problem.

1.3 Specifications

1.3.1 System

- **CPU:** Intel Pentium® III processor up to 933 MHz, Celeron® up to 733 MHz, FSB 66/100/133 MHz.
- **Firmware hub:** Provides security enhancements on computer platforms by supporting Random Number Generator (RNG).
- **BIOS:** Award Flash BIOS.
- **System Chipset:** Intel® 815E.
- **PCI enhanced IDE hard disk drive interface:** Supports up to four IDE (AT-bus) large hard disk drives or other enhanced IDE devices. Supports PIO mode 4 (16.67 MB/s data transfer rate) and Ultra ATA 100/66/33 (100/66/33 MB/s data transfer rate). BIOS enabled/disabled.
- **Floppy disk drive interface:** Supports up to two floppy disk drives, 5¼" (360 KB and 1.2 MB) and/or 3½" (720 KB, 1.44 MB, and 2.88 MB). BIOS enabled/disabled.

1.3.2 Memory

- **RAM:** Up to 512 MB in three available 168-pin DIMM sockets. Supports PC100/ PC133-compliant SDRAMs.
- **ECC (parity DRAM):** not supported.

1.3.3 Input/Output

- **Bus interface:** PCI/ISA bus, PICMG compliant.
- **Enhanced parallel port:** Configurable to LPT1 or disabled. Standard DB-25 female connector provided. Supports EPP/ECP.
- **Serial ports:** Two RS-232 ports with 16C550 UARTs (or compatible) with 16-byte FIFO buffer. Supports speeds up to 115.2 Kbps. Ports can be individually configured to COM1, COM2, or disabled.

- **Keyboard and PS/2 mouse connector:** A 6-pin mini-DIN connector is located on the mounting bracket for easy connection to a keyboard or a PS/2 mouse. An onboard keyboard pin header connector is also available.
- **HISA®:** ISA bus high-driving capability up to 64 mA.

1.3.4 VGA interface

- **Supports AGP 2X, 133 MHz.**
- **Controller:** Chipset integrated.

1.3.5 SCSI interface

- **PCI SCSI:** Supports 32-bit PCI interface and Ultra 160 SCSI or legacy single-ended devices; data transfer up to 160 MB/sec.
- **Chipset:** Adaptec AIC-7892.

1.3.6 Ethernet LAN

- **Supports dual 10/100Base-T Ethernet networking.**
- **Chipset:** One onboard Intel® GD82559 and one chipset integrated LAN controller.

1.3.7 Industrial features

- **Watchdog timer:** Can generate a system reset or IRQ11. The watchdog timer is programmable, from one second to 255 minutes (255 levels). See Appendix A for the programming details.

1.3.8 Mechanical and environmental specifications

- **Operating temperature:** 0°~60° C (32° ~ 140° F).

Note: The temperature depends on which CPU is used. The range is 0°~50° (32°~122°F) for a Pentium® III 933 MHz.

- **Storage temperature:** 0°~ 60° C (32° ~ 140° F).
- **Humidity:** 20 ~ 95% non-condensing.

- **Power supply voltage:** +5 V, \pm 12 V.
- **Power consumption** (depends on CPU and memory):
+5 V @ 6 A (typical, with Pentium III 866 MHz and 128MB SDRAM).
- **Board size:** 338 x 122 mm (13.3" x 4.8").
- **Board weight:** 0.5 kg (1.2 lb).

1.4 Board Layout: Main Features

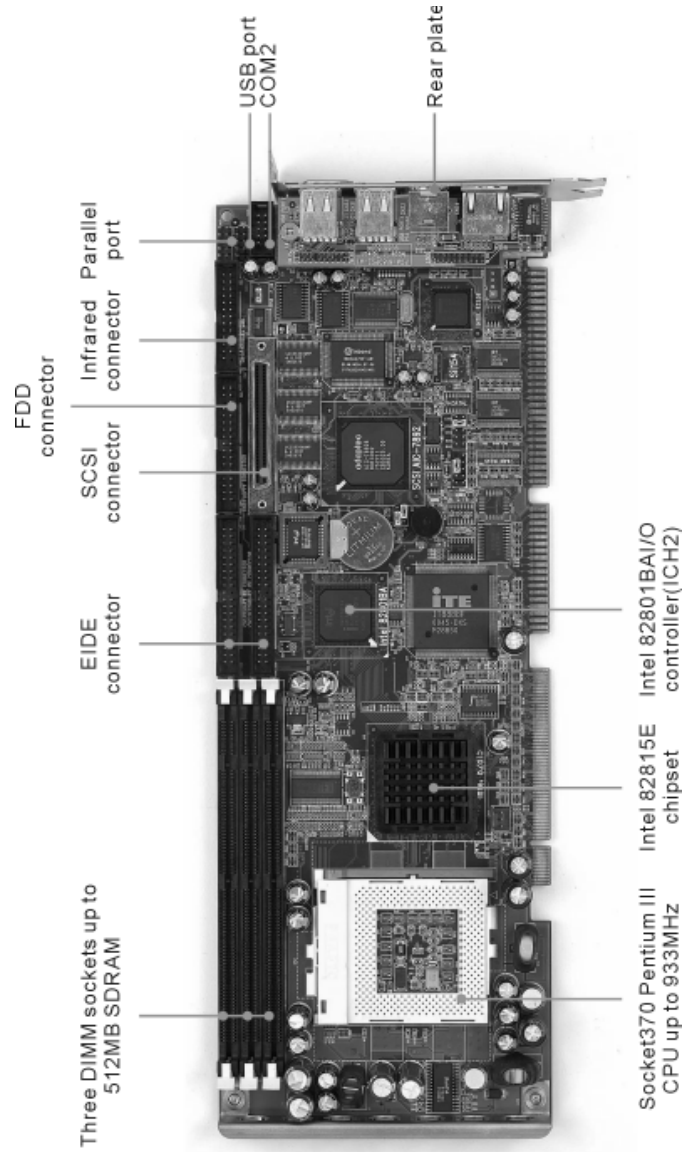

Figure 1-1: Board layout: main features

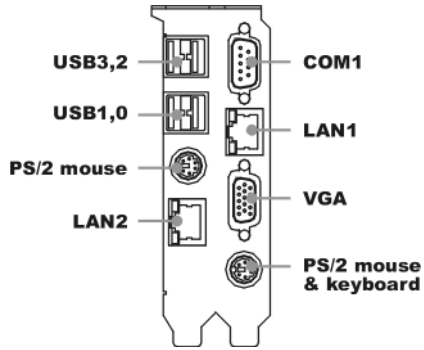

Figure 1-2: Rear plate

1.5 Jumpers and Connectors

Connectors on the PCA-6180 board link it to external devices such as hard disk drives and a keyboard. In addition, the board has a number of jumpers used to configure your system for your application.

The tables below list the function of each of the board jumpers and connectors. Later sections in this chapter give instructions on setting the jumpers. Chapter 2 gives instructions for connecting external devices to your card.

Table 1-1: Jumpers

Label	Function
J1	CMOS clear
J2	Watchdog timer output selection

Table 1-2: Connectors

Label	Function
CN1	Primary IDE connector
CN2	Secondary IDE connector
CN3	Floppy drive connector
CN4	Parallel port
CN5	SCSI connector
CN6	USB port
CN7	VGA connector
CN8	10/100Base-T Ethernet connector 1
CN9	Serial port: COM1
CN10	Serial port: COM2
CN11	PS/2 keyboard and mouse connector
CN12	External keyboard connector
CN13	Infrared (IR) connector
CN14	CPU fan connector
CN16	Keyboard lock and power LED
CN17	External speaker
CN18	Reset connector
CN19	HDD LED connector
CN20	ATX feature connector
CN21	ATX soft power switch
CN22	H/W monitor alarm: close - enable OBS alarm open - disable OBS alarm
CN23	SM bus connector
CN26	Reserved
CN27	Connector to extension I/O board
CN28	Connector to extension I/O board

Extension I/O board

CN31	USB port 0,1
CN32	USB port 2,3
CN33	PS/2 mouse connector
CN34	10/100Base-T Ethernet connector 2

1.6 Location of Jumpers and Connectors

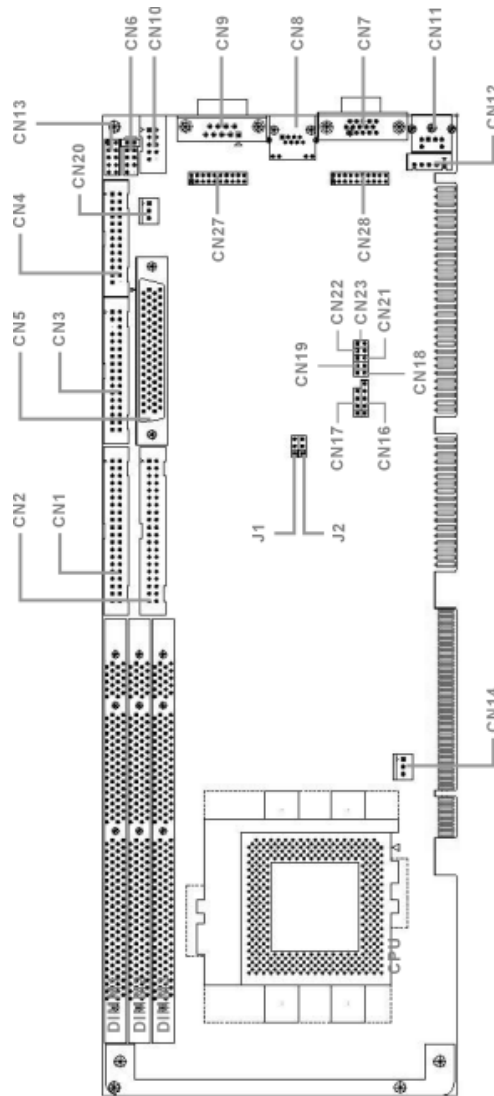

Figure 1-3: Location of jumpers and connectors

Note: See Chapter 2 for the location of CN31~CN34.

1.7 Safety Precautions

Warning! Always completely disconnect the power cord from your chassis whenever you work with the hardware.



Do not make connections while the power is on. Sensitive electronic components can be damaged by sudden power surges. Only experienced electronics personnel should open the PC chassis.

Caution! Always ground yourself to remove any static charge before touching the CPU card. Modern electronic devices are very sensitive to static electric charges. As a safety precaution, use a grounding wrist strap at all times. Place all electronic components on a static-dissipative surface or in a static-shielded bag when they are not in the chassis.



1.8 Jumper Settings

This section provides instructions on how to configure your card by setting the jumpers. It also includes the card's default settings and your options for each jumper.

1.8.1 How to set the jumpers



You configure your card to match the needs of your application by setting the jumpers. A jumper is a metal bridge that closes an electrical circuit. It consists of two metal pins and a small metal clip (often protected by a plastic cover) that slides over the pins to connect them. To “close” (or turn ON) a jumper, you connect the pins with the clip. To “open” (or turn OFF) a jumper, you remove the clip. Sometimes a jumper consists of a set of three pins, labeled 1, 2, and 3. In this case you connect either pins 1 and 2, or 2 and 3.

A pair of needle-nose pliers may be useful when setting jumpers.

1.8.2 CMOS clear (J1)

The PCA-6180 CPU card contains a jumper that can erase CMOS data and reset the system BIOS information. Normally this jumper should be set with pins 1-2 closed. If you want to reset the CMOS data, set J1 to 2-3 closed for just a few seconds, and then move the jumper back to 1-2 closed. This procedure will reset the CMOS to its default setting.

Table 1-3: CMOS clear (J1)



Function	Jumper setting	
* Keep CMOS data	1-2 closed	
Clear CMOS data	2-3 closed	

* default setting

1.8.3 Watchdog timer output (J2)

The PCA-6180 contains a watchdog timer that will reset the CPU or send a signal to IRQ11 in the event the CPU stops processing. This feature means the PCA-6180 will recover from a software failure or an EMI problem. The J2 jumper settings control the outcome of what the computer will do in the event the watchdog timer is tripped.

Table 1-4: Watchdog timer output (J2)

Function	Jumper setting	
IRQ11	1-2 closed	
* Reset	2-3 closed	

* default setting

Note: *The interrupt output of the watchdog timer is a low level signal. It will be held low until the watchdog timer is reset.*

1.9 System Memory

The top-left edge of the PCA-6180 contains three sockets for 168-pin dual in-line memory modules (DIMMs). All three sockets use 3.3 V unbuffered synchronous DRAMs (SDRAM). DIMMs are available in capacities of 16, 32, 64, 128, or 256 MB. The sockets can be filled in any combination with DIMMs of any size, giving your PCA-6180 single board computer between 16 MB and 512 MB of memory. Use the following table to calculate the total DRAM memory within your computer:

Table 1-5: DIMM module allocation table

Socket number	168-pin DIMM memory
1	(16, 32, 64, 128, or 256 MB) x 1
2	(16, 32, 64, 128, or 256 MB) x 1
3	(16, 32, 64, 128, or 256 MB) x 1

1.9.1 Sample calculation: DIMM memory capacity

Suppose you install a 128 MB DIMM into your PCA-6180's socket 1 and a 32 MB DIMM into sockets 2 and 3. Your total system memory is 192 MB, calculated as follows:

Table 1-6: DIMM memory capacity sample calculation

Socket number	168-pin DIMM memory		Total memory
1	128 MB	x 1	128 MB
2	32 MB	x 1	32 MB
3	32 MB	x 1	32 MB
Total memory			192 MB

1.9.2 Supplementary information about DIMMs

Your PCA-6180 can accept SDRAM memory chips (with or without parity). Also note:

- If the PCA-6180 operates at 133 MHz, only use PC/133-compliant DIMMs. Most systems will not even boot if non-compliant modules are used. This is due to strict timing issues involved at this speed.
- Chips with 9 chips/side support ECC; chips with 8 chips/side do not support ECC. PCA-6180 does not support ECC.
- Single-sided modules are typically 16, 32, or 64 MB; double-sided modules are usually 32, 64, 128, or 256 MB.

1.10 Memory Installation Procedures

To install DIMMs, first make sure the two handles of the DIMM socket are in the "open" position (i.e., the handles lean outward). Slowly slide the DIMM module along the plastic guides on both ends of the socket. Then press the DIMM module right down into the socket, until you hear a click. This is when the two handles have automatically locked the memory module into the correct position of the DIMM socket. To remove the memory module, just push both handles outward, and the memory module will be ejected by the mechanism in the socket.

1.11 Cache Memory

Since the second-level (L2) cache has been embedded into the Intel® FC-PGA Pentium® III processor, you do not have to take care of either SRAM chips or SRAM modules. The built-in second-level cache in the processor yields much higher performance than the external cache memories. The cache size in the Intel® FC-PGA Pentium® III processor is 256 KB. In the Celeron CPU, the cache size is 128KB.

1.12 CPU Installation

The PCA-6180 provides a socket 370 for an Intel® FC-PGA Pentium® III processor. The CPU on the board must have a fan or heat sink attached to prevent overheating.

Warning: *Without a fan or heat sink, the CPU will overheat and cause damage to both the CPU and the motherboard.*



To install a CPU, first turn off your system and remove its cover. Locate the processor socket 370.

1. Make sure the socket 370 lever is in the upright position. To raise the lever, pull it out to the side a little and raise it as far as it will go.
2. Place the CPU in the empty socket. Follow the instructions that came with the CPU. If you have no instructions, complete the following procedure. Carefully align the CPU so it is parallel to the socket and the notches on the corners of the CPU correspond with the notches on the inside of the socket. Gently slide the CPU in. It should insert easily. If it does not insert easily, pull the lever up a little bit more.
3. Press the lever down. The plate will slide forward. You will feel some resistance as the pressure starts to secure the CPU in the socket. This is normal and will not damage the CPU.

When the CPU is installed, the lever should snap into place at the side of the socket.

Note: *To remove a CPU, pull the lever out to the side a little and raise it as far as it will go. Lift out the CPU.*

CHAPTER 2

Connecting Peripherals

This chapter tells how to connect peripherals, switches, and indicators to the PCA-6180 board.

2.1 Introduction

You can access most of the connectors from the top of the board while it is installed in the chassis. If you have a number of cards installed or have a packed chassis, you may need to partially remove the card to make all the connections.

Note: If your chassis has only one empty expansion slot to accommodate the CPU card, you can replace the standard dual-slot bracket with the single-slot bracket included in your PCA-6180 package, in which case you will have to access the connectors (CN31~34) on the extension I/O board from inside the chassis.

2.2 Primary (CN1) and Secondary (CN2) IDE Connectors

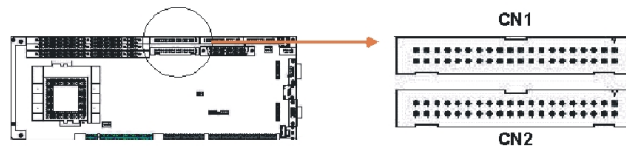

You can attach up to four IDE (Integrated Drive Electronics) drives to the PCA-6180's built-in controller. The primary (CN1) and secondary (CN2) connectors can each accommodate two drives.

Wire number 1 on the cable is red or blue and the other wires are gray. Connect one end to connector CN1 or CN2 on the CPU card. Make sure that the red/blue wire corresponds to pin 1 on the connector (in the upper right hand corner). See Chapter 1 for help finding the connector.

Unlike floppy drives, IDE hard drives can connect in either position on the cable. If you install two drives to a single connector, you will need to set one as the master and the other as the slave. You do this by setting the jumpers on the drives. If you use just one drive per connector, you should set each drive as the master. See the documentation that came with your drive for more information.

Connect the first hard drive to the other end of the cable. Wire 1 on the cable should also connect to pin 1 on the hard drive connector, which is labeled on the drive circuit board. Check the documentation that came with the drive for more information.

Connect the second hard drive to the remaining connector (CN2 or CN1), in the same way as described above.

Note: The PCA-6180 supports the Ultra ATA/100 interface and requires special IDE cables as well as a software driver to enable this function. See Chapter 7 for more information.

2.3 Floppy Drive Connector (CN3)

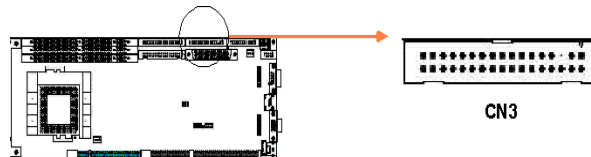

You can attach up to two floppy disk drives to the PCA-6180's onboard controller. You can use 3.5" (720 KB, 1.44/2.88 MB) drives.

The card comes with a 34-pin daisy-chain drive connector cable. On one end of the cable is a 34-pin flat-cable connector. On the other end are two sets of 34-pin flat-cable connector (usually used for 3.5" drives). The set on the end (after the twist in the cable) connects to the A: floppy drive. The set in the middle connects to the B: floppy drive.

2.4 Parallel Port (CN4)

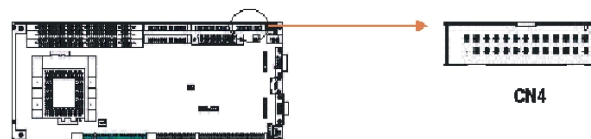

The parallel port is normally used to connect the CPU card to a printer. The PCA-6180 includes an onboard parallel port, accessed through a 26-pin flat-cable connector, CN4. The card comes with an adapter cable which lets you use a traditional DB-25 connector. The cable has a 26-pin connector on one end and a DB-25 connector on the other, mounted on a retaining bracket. The bracket installs at the end of an empty slot in your chassis, giving you access to the connector.

To install the bracket, find an empty slot in your chassis. Unscrew the plate that covers the end of the slot. Screw in the bracket in place of the plate. Next, attach the flat-cable connector to CN4 on the CPU card. Wire 1 of the cable is red or blue, and the other wires are gray. Make sure that wire 1 corresponds to pin 1 of CN4. Pin 1 is on the upper right side of CN4.

2.5 SCSI Connector (CN5)

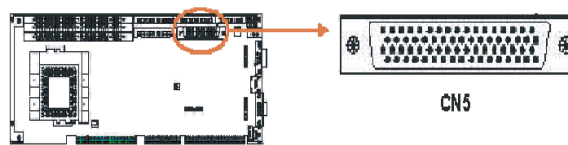

The PCA-6180 has a 68-pin, dual in-line connector for Ultra 160 SCSI devices. Connection of SCSI devices requires special attention, especially when determining the last drive on the SCSI chain. Refer to Chapter 9 and your device's operating manual for detailed installation advice.

2.6 USB Ports (CN31 and CN32)

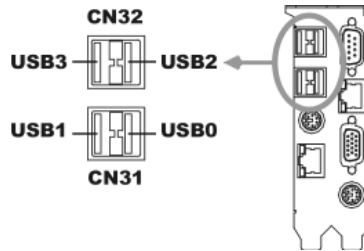

The PCA-6180 provides four ports of USB (Universal Serial Bus) interface, which gives complete Plug & Play and hot swapping for up to 127 external devices. The USB interface complies with USB Specification Rev. 1.0 and is fuse-protected.

The USB interface can be disabled in the system BIOS setup.

2.7 VGA Connector (CN7)

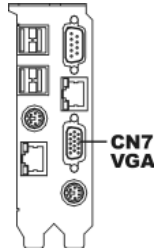

The PCA-6180 includes an AGP SVGA interface that can drive conventional CRT displays. CN7 is a standard 15-pin D-SUB connector commonly used for VGA. Pin assignments for CRT connector CN7 are detailed in Appendix B.

2.8 10/100Base-T Ethernet Connectors (CN8 and CN34)

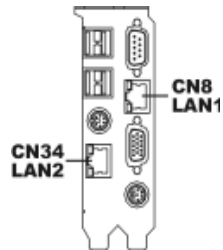

The PCA-6180 is equipped with one or two high-performance 32-bit PCI-bus Ethernet interfaces, which are fully compliant with IEEE 802.3/u 10/100 Mbps CSMA/CD standards. They are supported by all major network operating systems and are 100% Novell NE-2000 compatible. The RJ-45 jacks on the rear plate provide convenient 10/100Base-T RJ-45 operation.

2.9 Serial Ports (CN9: COM1; CN10: COM2)

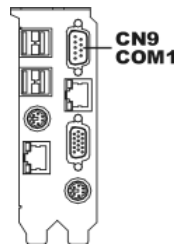

The PCA-6180 offers two serial ports, CN9 as COM1 and CN10 as COM2. These ports can connect to serial devices, such as a mouse or a printer, or to a communications network.

Table 2-1: Serial port connections (COM1, COM2)

Connector	Ports	Address	Interrupt
CN9	COM1	3F8*, 3E8	IRQ4
CN10	COM2	2F8*, 2E8	IRQ3

* default settings

The IRQ and address ranges for both ports are fixed. However, if you want to disable the port or change these parameters later, you can do this in the system BIOS setup.

Different devices implement the RS-232 standard in different ways. If you are having problems with a serial device, be sure to check the pin assignments for the connector.

2.10 PS/2 Keyboard and Mouse Connectors (CN11 and CN33)

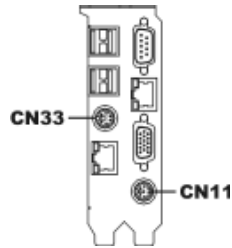

Two 6-pin mini-DIN connectors (CN11 and CN33) on the card mounting bracket provide connection to a PS/2 keyboard and a PS/2 mouse, respectively. CN11 can also be connected to an adapter cable (P/N: 1700060202, available from Advantech) for connecting to both a PS/2 keyboard and a PS/2 mouse.

2.11 External Keyboard Connector (CN12)

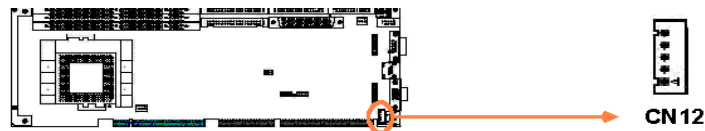

In addition to the PS/2 mouse/keyboard connector on the PCA-6180's rear plate, there is also an extra onboard external keyboard connector. This gives system integrators greater flexibility in designing their systems.

2.12 Infrared (IR) Connector (CN13)



This connector supports the optional wireless infrared transmitting and receiving module. This module mounts on the system case. You must configure the setting through the BIOS setup (see Chapter 3).

2.13 CPU Fan Connector (CN14)

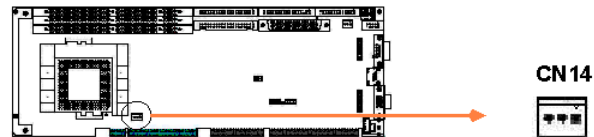

This connector supports cooling fans of 500 mA (6 W) or less.

2.14 Front Panel Connectors (CN16, CN17, CN18, CN19, CN21 and CN22)

There are several external switches to monitor and control the PCA-6180.

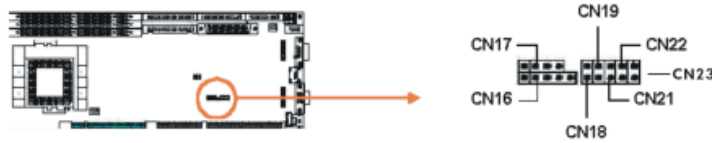

2.14.1 Keyboard lock and power LED (CN16)

CN16 is a 5-pin connector for the keyboard lock and power on LED. Refer to Appendix B for detailed information on the pin assignments. If a PS/2 or ATX power supply is used, the system's power LED status will be as indicated below:

Table 2-2: PS/2 or ATX power supply LED status

Power mode	LED (PS/2 power)	LED (ATX power)
System On	On	On
System Suspend	Fast flashes	Fast flashes
System Off	Off	Slow flashes

2.14.2 External speaker (CN17)

CN17 is a 4-pin connector for an external speaker. If there is no external speaker, the PCA-6180 provides an onboard buzzer as an alternative. To enable the buzzer, set pins 3-4 as closed.

2.14.3 Reset (CN18)

Many computer cases offer the convenience of a reset button. Connect the wire from the reset button to CN18.

2.14.4 HDD LED (CN19)

You can connect an LED to connector CN19 to indicate when the HDD is active.

2.14.5 ATX soft power switch (CN21)

If your computer case is equipped with an ATX power supply, you should connect the power on/off button on your computer case to CN21. This connection enables you to turn your computer on and off.

2.15 ATX Power Control Connectors (CN20 and CN21)



Note: Refer to the diagram on the previous page for the location of CN21.

2.15.1 ATX feature connector (CN20) and soft power switch connector (CN21)

The PCA-6180 can support an advanced soft power switch function if an ATX power supply is used. To enable the soft power switch function:

1. Take the specially designed ATX-to-PS/2 power cable out of the PCA-6180's accessory bag.
2. Connect the 3-pin plug of the cable to CN20 (ATX feature connector).
3. Connect the power on/off button to CN21. (A momentary type of button should be used.)

Note: If you will not be using an ATX power connector, make sure that pins 2-3 of CN20 are closed.

Warnings: 1. Make sure that you unplug your power supply when adding or removing expansion cards or other system components. Failure to do so may cause severe damage to both your CPU card and expansion cards.



2. ATX power supplies may power on if certain motherboard components or connections are touched by metallic objects.

Important: Make sure that the ATX power supply can take at least a 720 mA load on the 5 V standby lead (5VSB). If not, you may have difficulty powering on your system and/or supporting the "Wake-on-LAN" function.

2.15.2 Controlling the soft power switch

Users can also identify the current power mode through the system's power LED (see Section 2.13.1).

2.16 SM Bus Connector (CN23)

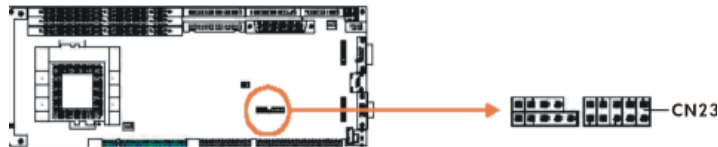

This connector can be used for external devices which need to be connected to the SM bus (system management bus).

CHAPTER 3

Award BIOS Setup

This chapter describes how to set the card's BIOS configuration data.

3.1 Introduction

Award's BIOS ROM has a built-in setup program that allows users to modify the basic system configuration. This type of information is stored in battery-backed memory (CMOS RAM) so that it retains the setup information when the power is turned off.

3.2 Entering Setup

Turn on the computer and check for the "patch code". If there is a number assigned to the patch code, it means that the BIOS supports your CPU.

If there is no number assigned to the patch code, please contact Advantech's applications engineer to obtain an up-to-date patch code file. This will ensure that your CPU's system status is valid.

After ensuring that you have a number assigned to the patch code, press to allow you to enter the setup.



Figure 3-1: Award BIOS Setup initial screen

3.3 Standard CMOS Setup

Choose the “Standard CMOS Features” option from the “Initial Setup Screen” menu, and the screen below will be displayed. This menu allows users to configure system components such as date, time, hard disk drive, floppy drive, display, and memory.

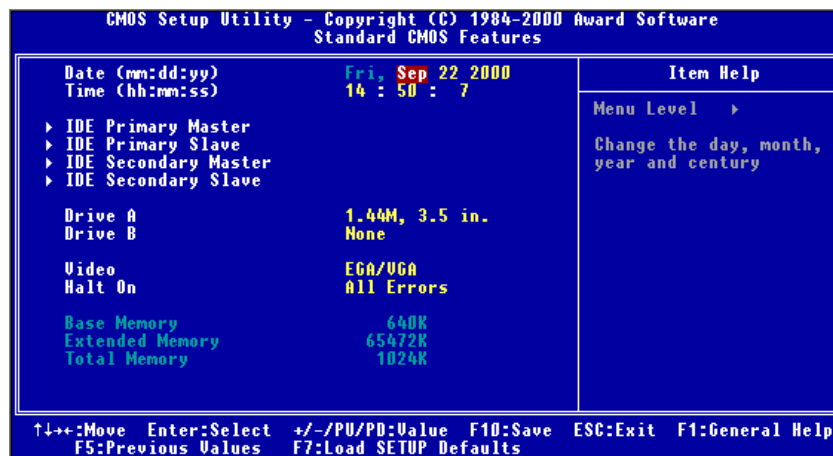

Figure 3-2: Standard CMOS features screen

3.3.1 CMOS RAM backup

The CMOS RAM is powered by an onboard button cell battery.

When BIOS CMOS Setup has been completed, CMOS RAM data is automatically backed up to Flash ROM. If conditions in a harsh industrial environment cause a soft error, BIOS will recheck the data and automatically restore the original data for booting.

Note: If you intend to update CMOS RAM data, you have to click on “DEL” within two seconds of the “CMOS checksum error...” display screen message appearing. Then enter the “Setup” screen to modify the data. If the “CMOS checksum error...” message appears again and again, please check to see if you need to replace the battery in your system.

3.4 Advanced BIOS Features

The “Advanced BIOS Features” screen appears when choosing the “Advanced BIOS Features” item from the “Initial Setup Screen” menu. It allows the user to configure the PCA-6180 according to his particular requirements.

Below are some major items that are provided in the Advanced BIOS Features screen.

A quick booting function is provided for your convenience. Simply enable the Quick Booting item to save yourself valuable time.

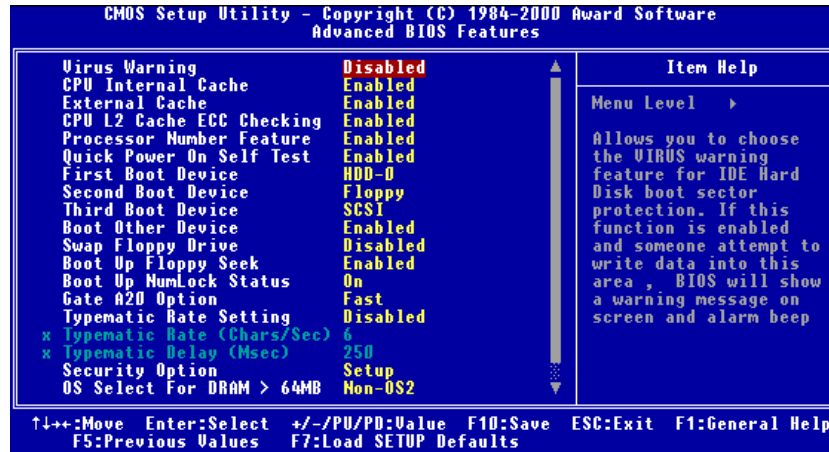

Figure 3-3: Advanced BIOS features screen (1)

3.4.1 Virus Warning

If enabled, a warning message and alarm beep activates if someone attempts to write here. The commands are “Enabled” or “Disabled.”

3.4.2 CPU Internal Cache / External Cache

Enabling this feature speeds up memory access. The commands are “Enabled” or “Disabled.”

3.4.3 CPU L2 Cache ECC Checking

Enabling allows CPU L2 cache checking. The commands are “Enabled” or “Disabled.”

3.4.4 Quick Power On Self Test

This option speeds up the Power On Self Test (POST) conducted as soon as the computer is turned on. When enabled, BIOS shortens or skips some of the items during the test. When disabled, the computer conducts normal POST procedures. The commands are “Enabled” or “Disabled.”

3.4.5 First/Second/Third/Other Boot Device

The BIOS tries to load the OS with the devices in the sequence selected.

Choices are: Floppy, LS/ZIP, HDD, SCSI, CDROM, LAN, Disabled.

3.4.6 Swap Floppy Drive

Logical name assignments of floppy drives can be swapped if there is more than one floppy drive. The commands are “Enabled” or “Disabled.”

3.4.7 Boot UP Floppy Seek

Selection of the command “Disabled” will speed the boot up. Selection of “Enabled” searches disk drives during boot up.

3.4.8 Boot Up NumLock

This feature selects the “power on” state for NumLock. The commands are “Enabled” or “Disabled.”

3.4.9 Gate A20 Option

Normal The A20 signal is controlled by the keyboard controller.

Fast (Default) The A20 signal is controlled by the chipset.

3.4.10 Typematic Rate Setting

The typematic rate is the rate key strokes repeat as determined by the keyboard controller. The commands are “Enabled” or “Disabled.” Enabling allows the typematic rate and delay to be selected.

3.4.11 Typematic Rate (Chars/Sec)

BIOS accepts the following input values (characters/second) for typematic rate: 6, 8, 10, 12, 15, 20, 24, 30.

3.4.12 Typematic Delay (msec)

Typematic delay is the time interval between the appearance of two consecutive characters, when holding down a key. The input values for this category are: 250, 500, 750, 1000 (msec).

3.4.13 Security Option

This setting determines whether the system will boot up if the password is denied. Access to Setup is, however, always limited.

System The system will not boot, and access to Setup will be denied if the correct password is not entered at the prompt.

Setup The system will boot, but access to Setup will be denied if the correct password is not entered at the prompt.

Note: To disable security, select “PASSWORD SETTING” in the main menu. At this point, you will be asked to enter a password. Simply press <Enter> to disable security. When security is disabled, the system will boot, and you can enter Setup freely.

3.4.14 OS Select for DRAM > 64MB

This setting allows selecting an OS with greater than 64MB of RAM. Commands are “Non-OS2” or “OS2.”

3.4.15 Report No FDD For Win 95

This reports if an FDD is available for Windows 95. The commands are “Yes” or “No.”



Figure 3-4: Advanced BIOS features screen (2)

3.5 Advanced Chipset Features

By choosing the “Advanced Chipset Features” option from the “Initial Setup Screen” menu, the screen below will be displayed. This sample screen contains the manufacturer’s default values for the PCA-6180, as shown in Figure 3-5:

Note: DRAM default timings have been carefully chosen and should ONLY be changed if data is being lost. Please first contact technical support.

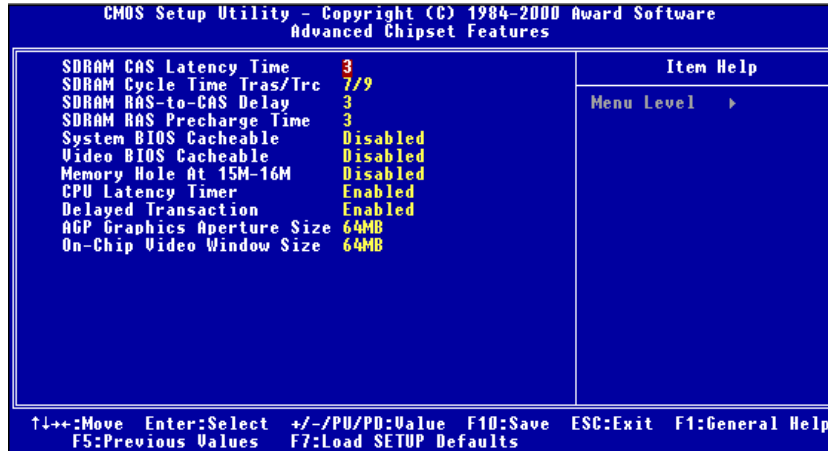

Figure 3-5: Advanced chipset features screen

3.5.1 SDRAM CAS Latency Time

This controls the latency between SDRAM read command and the time that the data actually becomes available. Leave this on the default setting.

3.5.2 SDRAM Cycle Time Tras/Trc

This selects the number of SCLKs for an access cycle.

3.5.3 SDRAM RAS-to-CAS Delay

This controls the latency between SDRAM active command and the read/write command. Leave this on the default setting.

3.5.4 SDRAM RAS Precharge Time

This controls the idle clocks after issuing a precharge command to SDRAM. Leave this on the default setting.

3.5.5 System BIOS Cacheable

Selecting Enabled allows caching of the system BIOS ROM at F0000h-FFFFFh, resulting in better system performance. However, if any program writes to this memory area, a system error may occur. The Choices: Enabled, Disabled.

3.5.6 Video Bios Cacheable

Selecting Enabled allows caching of the video BIOS, resulting in better system performance. However, if any program writes to this memory area, a system error may occur. The Choices: Enabled, Disabled.

3.5.7 Memory Hole At 15M-16M

Enabling this feature reserves 15 MB to 16 MB memory address space for ISA expansion cards that specifically require this setting. This makes memory from 15 MB and up unavailable to the system. Expansion cards can only access memory up to 16 MB. The default setting is “Disabled.”

3.5.8 CPU Latency Timer

When enabled, the CPU cycle will only be deferred after it has been held in a “Snoop Stall” for 31 clocks and another ADS# has arrived. When disabled, the CPU cycle will be deferred immediately after the GMCH receives another ADS#. The Choices: Enabled, Disabled.

3.5.9 Delayed Transaction

The chipset has an embedded 32-bit posted write buffer to support delay transactions cycles. Select Enabled to support compliance with PCI specification version 2.1. The Choice: Enabled, Disabled.

3.5.10 AGP Graphics Aperture Size (MB)

Memory-mapped, graphics data structures can reside in a graphics aperture. Choices are: 4M, 8M, 16M, 32M, 65M, 128M, 256M.

3.5.11 On-Chip Video Window Size

This selects the on-chip video window size for VGA drives use. The Choices: 32MB, 64MB, Disabled.

3.6 Integrated Peripherals

3.6.1 On-Chip Primary/Secondary PCI IDE

If you enable IDE HDD Block Mode, the enhanced IDE driver will be enabled. Leave IDE HDD Block Mode on the default setting.

3.6.2 IDE Primary Master/Slave PIO/UDMA Mode, IDE Secondary Master/Slave PIO/UDMA Mode (Auto)

Each channel (Primary and Secondary) has both a master and a slave, making four IDE devices possible. Because each IDE device may have a different Mode timing (0, 1, 2, 3, 4), it is necessary for these to be independent. The default setting “Auto” will allow autodetection to ensure optimal performance.

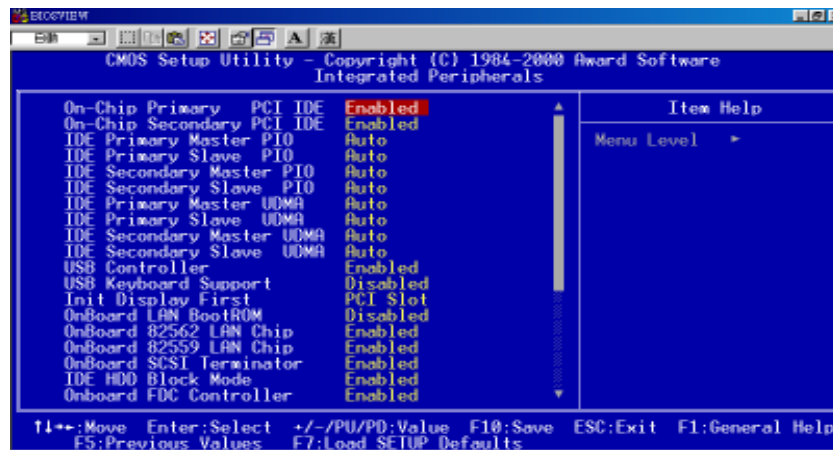

Figure 3-6: Integrated peripherals (1)

3.6.3 USB Controller

Select Enabled if your system contains a Universal Serial Bus (USB) controller and you have USB peripherals. The choices: Enabled, Disabled.

3.6.4 USB Keyboard Support

Select Enabled if your system contains a Universal Serial Bus (USB) controller and you have a USB keyboard. The choices: Enabled, Disabled.

3.6.5 Init Display First

This item allows you to choose which one to activate first, PCI Slot or on-chip VGA. The choices: PCI Slot, Onboard.

3.6.6 IDE HDD Block Mode

You can enable the Primary IDE channel and/or the Secondary IDE channel. Any channel not enabled is disabled. This field is for systems with only SCSI drives.

3.6.7 Onboard FDC Controller

When enabled, this field allows you to connect your floppy disk drives to the onboard floppy disk drive connector instead of a separate controller card. If you want to use a different controller card to connect the floppy disk drives, set this field to Disabled.

3.6.8 Onboard Serial Port 1 (3F8H/IRQ4)

The settings are 3F8H/IRQ4, 2F8H/IRQ3, 3E8H/IRQ4, 2E8H/IRQ10, and Disabled for the on-board serial connector.

3.6.9 Onboard Serial Port 2 (2F8H/IRQ3)

The settings are 3F8H/IRQ4, 2F8H/IRQ3, 3E8H/IRQ4, 2E8H/IRQ10, and Disabled for the on-board serial connector.

3.6.10 UART Mode Select

This item allows you to select UART mode. The choices: IrDA, ASKIR, Normal.

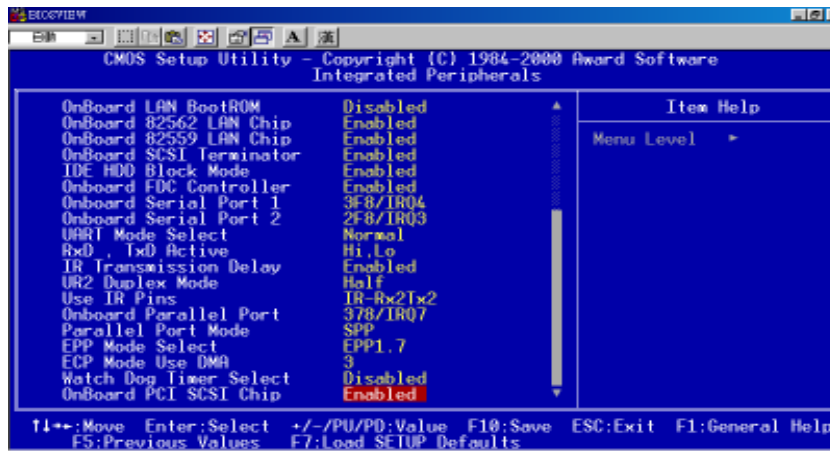

Figure 3-7: Integrated peripherals (2)

3.6.11 RxD, TxD Active

This item allows you to determine the active of RxD, TxD. The Choices: “Hi, Hi,” “Lo, Lo,” “Lo, Hi,” “Hi, Lo.”

3.6.12 IR Transmission Delay

This item allows you to enable/disable IR transmission delay. The choices: Enabled, Disabled.

3.6.13 UR2 Duplex Mode

This item allows you to select the IR half/full duplex function. The choices: Half, Full.

3.6.14 Use IR Pins

This item allows you to select IR transmission routes, one is Rx2D2, Tx2D2 (COM Port) and the other is IR-Rx2Tx2. The choices: IR-Rx2Tx2, Rx2D2, Tx2D2.

3.6.15 Onboard Parallel Port (378H/IRQ7)

This field sets the address of the on-board parallel port connector. You can select either 3BCH/IRQ7, 378H/IRQ7, 278H/IRQ5 or Disabled. If you install an I/O card with a parallel port, make sure there is no conflict in the address assignments. The CPU card can support up to three parallel ports, as long as there are no conflicts for each port.

3.6.16 Parallel Port Mode (ECP + EPP)

This field allows you to set the operation mode of the parallel port. The setting “Normal” allows normal speed operation, but in one direction only. “EPP” allows bidirectional parallel port operation at maximum speed. “ECP” allows the parallel port to operate in bidirectional mode and at a speed faster than the maximum data transfer rate. “ECP + EPP” allows normal speed operation in a two-way mode.

3.6.17 EPP Mode Select

This field allows you to select EPP port type 1.7 or 1.9. The choices: EPP1.7, 1.9.

3.6.18 ECP Mode Use DMA

This selection is available only if you select “ECP” or “ECP + EPP” in the Parallel Port Mode field. In ECP Mode Use DMA, you can select DMA channel 1, DMA channel 3, or Disable. Leave this field on the default setting.

3.7 Power Management Setup

The power management setup controls the CPU card's "green" features to save power. The following screen shows the manufacturer's defaults:

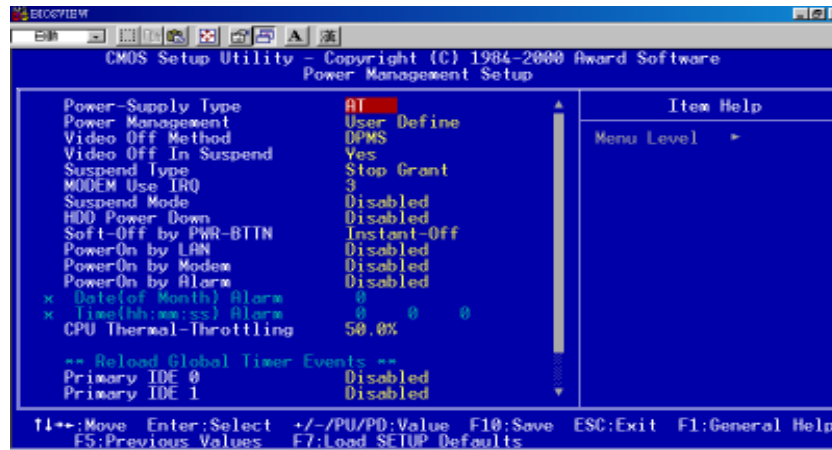

Figure 3-8: Power management setup screen

3.7.1 Power Management

This option allows you to determine if the values in power management are disabled, user-defined, or predefined.

3.7.2 HDD Power Down

You can choose to turn the HDD off after one of the time intervals listed, or when the system is in "suspend" mode. If the HDD is in a power saving mode, any access to it will wake it up.

Note: The HDD will not power down if the Power Management option is disabled.

3.7.3 Soft-Off by PWR-BTTN

If you choose "Instant-Off", then pushing the ATX soft power switch button once will switch the system to "system off" power mode.

You can choose “Delay 4 sec.” If you do, then pushing the button for more than 4 seconds will turn off the system, whereas pushing the button momentarily (for less than 4 seconds) will switch the system to “suspend” mode.

3.7.4 PowerOn By LAN

This item allows you to wake up the system via LAN from the remote host. The choices: Enabled, Disabled.

3.7.5 PowerOn By Modem

When Enabled, an input signal on the serial Ring Indicator (RI) line (in other words, an incoming call on the modem) awakens the system from a soft off state. The choices: Enabled, Disabled.

3.7.6 PowerOn By Alarm

When Enabled, you can set the date and time at which the RTC (real-time clock) alarm awakens the system from Suspend mode. The choices: Enabled, Disabled.

3.7.8 CPU Thermal-Throttling

This field allows you to select the CPU THRM-Throttling rate. The choices: 12.5%, 25.0%, 37.5%, 50.0%, 62.5%, 75.0%, 87.5%.

3.8 PnP/PCI Configurations

3.8.1 Resources controlled by:

The commands here are “Auto” or “Manual.” Choosing “manual” requires you to choose resources from each following sub-menu. “Auto” automatically configures all of the boot and Plug and Play devices but you must be using Windows 95 or above.

3.8.2 PnP OS Installed

This feature allows you to install the PnP OS. The commands are “Yes” or “No.”

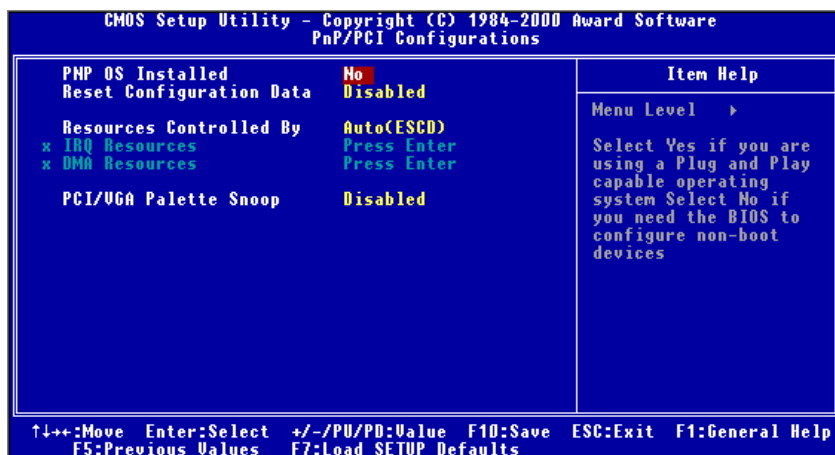

Figure 3-9: PnP/PCI configurations screen

3.8.3 Reset Configuration Data

Note: This is left “Disabled.” Select “Enabled” to reset Extended System Configuration Data (ECSD) if you have installed a new add-on and your OS won’t boot and you need to reconfigure.

3.8.4 PCI/VGA Palette Snoop

This is left at “Disabled.”

3.9 PC Health Status

3.9.1 CPU Warning Temperature

This item will prevent the CPU from overheating. The choices: 30~120.

3.9.2 Current System Temp.

This shows you the current system temperature.

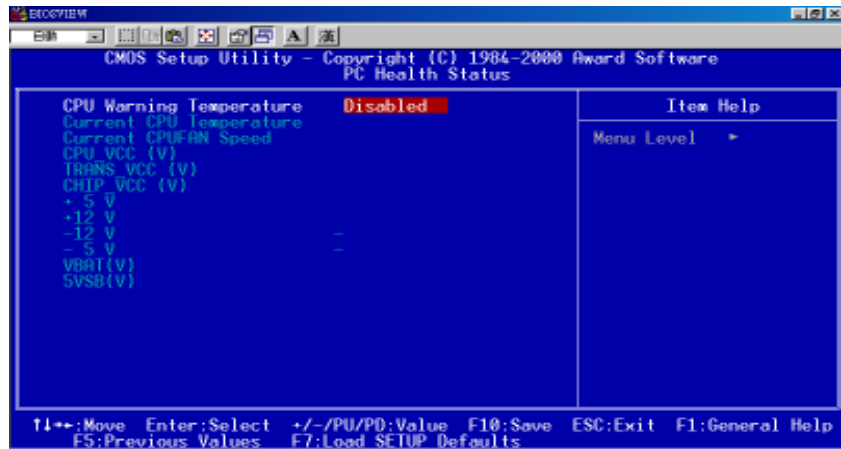

Figure 3-10: PC health status screen

3.9.3 Current CPU Temperature

This shows you the current CPU1 temperature.

3.9.4 Current CPUFAN Speed

This shows you the current CPUFAN operating speed.

3.9.5 +5V/+12V/-12V/-5V

This shows you the voltage of +5V/+12V/-12V/-5V.

3.9.6 Shutdown Temperature

This item allows you to set up the CPU shutdown Temperature. This item is effective only under Windows 98 ACPI mode. The Choices: Disabled, 60°C/140°F, 65°C/149°F, 70°C/159°F, 75°C/167°F.

3.10 Load Setup Defaults

“LOAD SETUP DEFAULTS” loads the values required by the system for maximum performance.

3.11 Password Setting

To change the password:

1. Choose the “Set Password” option from the “Initial Setup Screen” menu and press <Enter>.

The screen will display the following message:



Enter Password:

Press <Enter>.

2. If the CMOS is good or if this option has been used to change the default password, the user is asked for the password stored in the CMOS. The screen will display the following message:

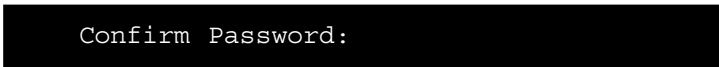

Confirm Password:

Enter the current password and press <Enter>.

3. After pressing <Enter> (ROM password) or the current password (user-defined), you can change the password stored in the CMOS. The password must be no longer than eight (8) characters.

Remember, to enable the password setting feature, you must first select either “Setup” or “System” from the “Advanced BIOS Features” menu.

3.12 Save & Exit Setup

If you select this and press <Enter>, the values entered in the setup utilities will be recorded in the CMOS memory of the chipset. The microprocessor will check this every time you turn your system on and compare this to what it finds as it checks the system. This record is required for the system to operate.

3.13 Exit Without Saving

Selecting this option and pressing <Enter> lets you exit the setup program without recording any new values or changing old ones.

CHAPTER 4

Chipset Software Installation (CSI) Utility

This utility software installs to the Windows INF files that outline to the operating system how the components will be configured. This utility has to be installed before other drivers.

4.1 Before You Begin

To facilitate the installation of the enhanced display device drivers and utility software, you should read the instructions in this chapter carefully before you attempt installation. The device drivers for the PCA-6180 board are located on the software installation CD. The auto-run function of the driver CD will guide and link you to the utilities and device drivers under a Windows system.

Note: *The files on the software installation CD are compressed. Do not attempt to install the drivers by copying the files manually. You must use the supplied SETUP program to install the drivers.*

Before you begin, it is important to note that many of the installation procedures assume that you are familiar with the operating system commands. Review the relevant operating system commands and the pertinent sections of your application software's user's manual before performing the installation.

4.2 Introduction

The Intel® Chipset Software Installation (CSI) utility installs to the target system the Windows INF files that outline to the operating system how the chipset components will be configured. This is needed for the proper functioning of the following features:

- Core PCI and ISA PnP services.
- AGP support.
- IDE Ultra ATA 100/66/33 interface support.
- USB support.
- Identification of Intel® chipset components in the Device Manager.

Note: This utility is used for the following versions of Windows system, and it has to be installed before installing all the other drivers:

<i>Windows 95</i>	<i>4.00.950 (Original release)</i>
<i>Windows 95</i>	<i>4.00.950a (OSR1)</i>
<i>Windows 95</i>	<i>4.00.950b (OSR2 without USB Supplement)</i>
<i>Windows 95</i>	<i>4.00.950b (OSR2.1 with USB Supplement)</i>
<i>Windows 95</i>	<i>4.00.950c (OSR2.5 with or without USB Supplement)</i>
<i>Windows 98</i>	<i>4.10.1998 (Original release)</i>
<i>Windows 98</i>	<i>Second Edition 4.10.2222 (Original release)</i>
<i>Windows 2000</i>	<i>5.00.2195 (Original release)</i>

4.3 Installing the CSI Utility

1. Insert the driver CD into your system's CD-ROM drive. In a few seconds, the software installation main menu appears. Move the mouse cursor over the "Auto" button under the "CSI UTILITY" heading, a message pops up telling you to install the CSI utility before other device drivers, as shown in the following figure. Click on this button.



2. Click "Next" when you see the following message.



3. Click "Yes" when you see the following message.

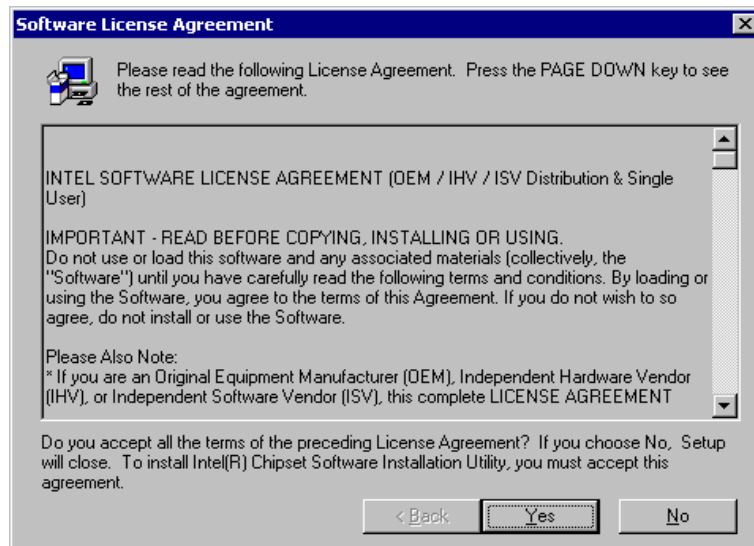

4. Click "Next" when you see the following message.

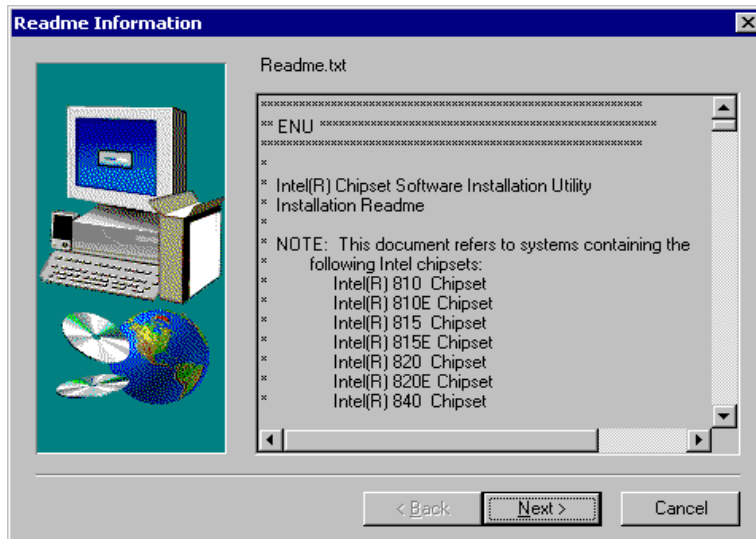

5. When the following message appears, click "Finish" to complete the installation and restart Windows.

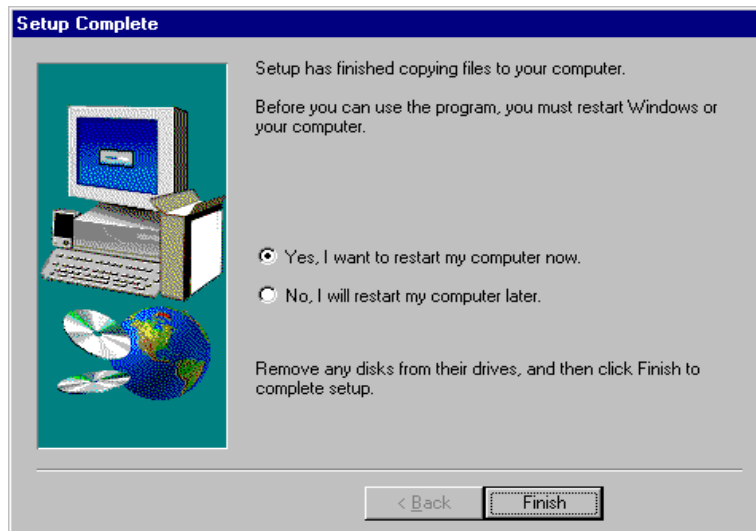

CHAPTER 5

AGP SVGA Setup

The PCA-6180 features an integrated AGP SVGA interface. This chapter provides instructions for installing the AGP SVGA drivers from the driver CD included in your package.

5.1 Introduction

AGP (Accelerated Graphics Port) is a graphics interface that provides faster connection between the display card and memory than a PCI slot. Your PCA-6180 CPU card uses the Intel® 815 chipset that supports AGP SVGA. The features include:

- Built-in 2D/3D AGP VGA controller.
- Integrated 24-bit 230MHz RAMDAC.
- Up to 1600 x 1200 resolution in 8-bit color at 85 Hz refresh.
- H/W motion compensation assistance for s/w MPEG 2 decoding.
- Software DVD at 30 fps.

5.2 Installation

Note: Before installing this driver, make sure the CSI utility has been installed in your system. See Chapter 4 for information on installing the CSI utility.

1. Insert the driver CD into your system's CD-ROM drive. In a few seconds, the software installation main menu appears, as shown in the following figure. Under the "VGA DRIVERS" heading, click on one of the buttons (labeled "WIN9X," "WIN2000," and "WINNT40" respectively) according to the operating system you are using.



2. Click "Next" when you see the following message.

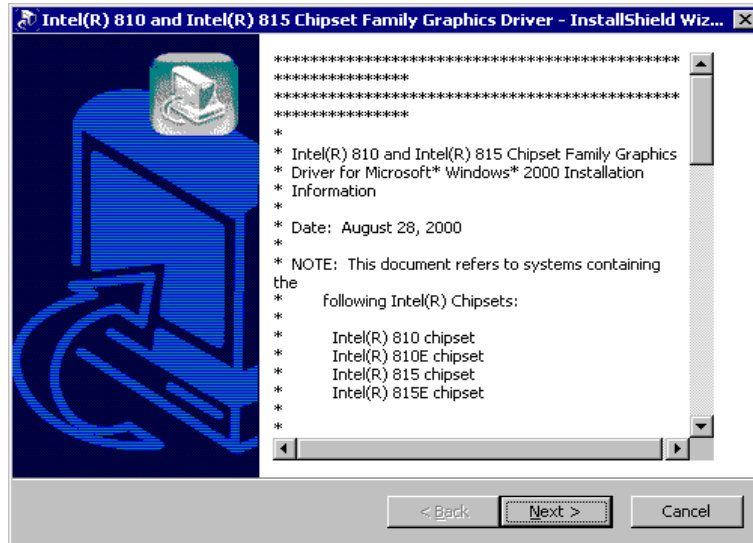

3. Click "Next" when you see the following message.

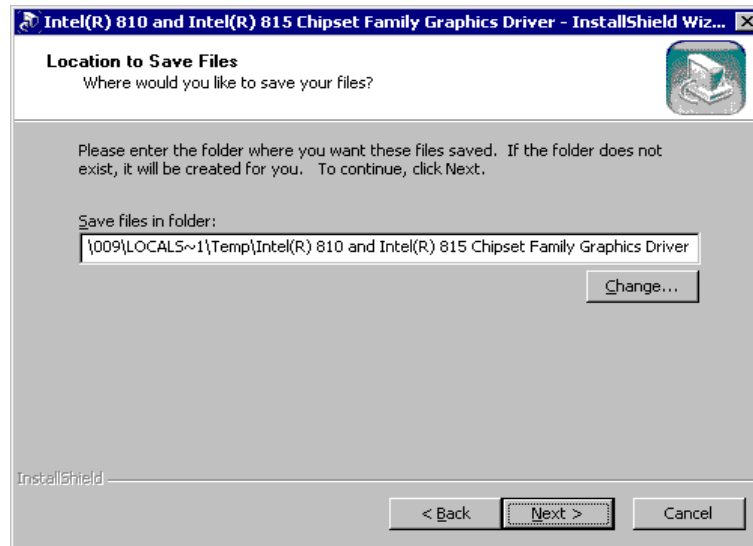

4. Click "Finish" when you see the following message.

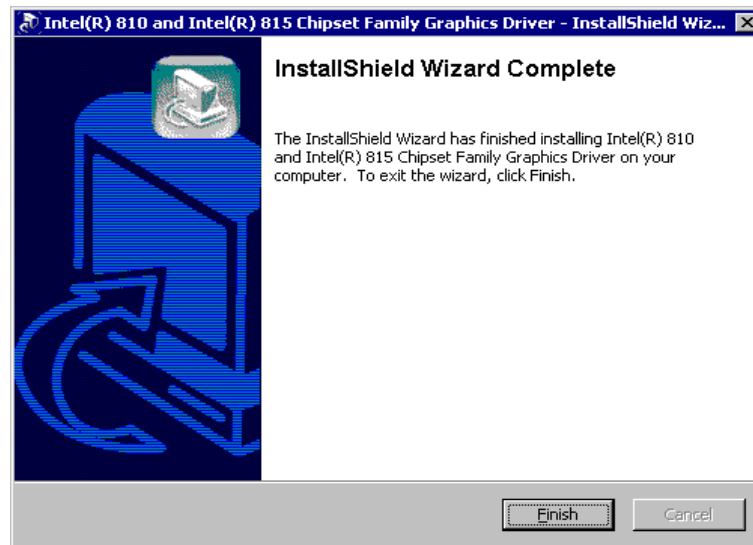

5. Click "Yes" to accept the License Agreement.

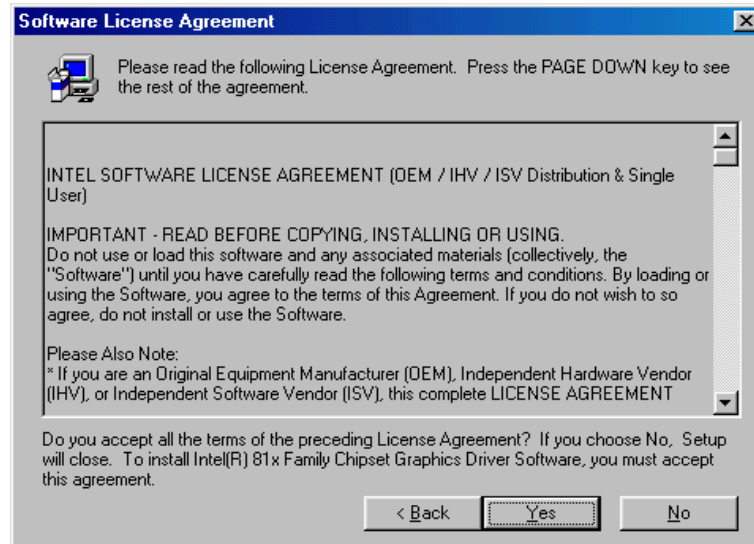

6. When the following message appears, click "Finish" to complete the installation and restart Windows.

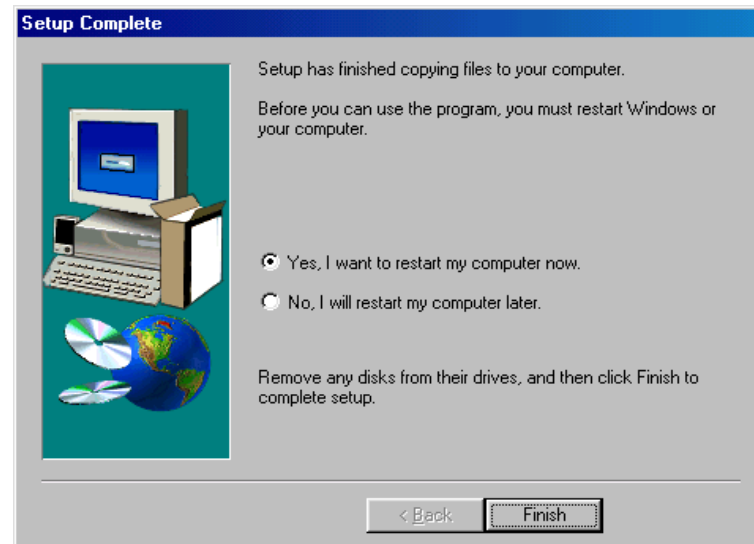

CHAPTER 6

LAN Configuration

The PCA-6180 supports dual 10/100Base-T Ethernet networking with one chipset integrated LAN controller (Intel® 82562ET) and one Intel® GD82559 (optional). This chapter gives detailed information on Ethernet configuration. It shows you how to configure the card to match your application requirements.

Sections include:

- Introduction
- Features
- Installation
- Windows 95/98/2000 Drivers Setup Procedure
- Windows NT Drivers Setup Procedure
- Windows 98SE/ME Drivers Setup Procedure
- Windows NT Wake-on-LAN Setup Procedure

6.1 Introduction

The PCA-6180 features the 32-bit 10/100 Mbps Ethernet network interface. This interface supports bus mastering architecture and auto-negotiation features. Therefore standard twisted-pair cabling with RJ-45 connectors for both 10 Mbps and 100 Mbps connections can be used. Extensive driver support for commonly-used network systems is also provided.

6.2 Features

- Intel® 82562ET integrated LAN controller.
- Optional Intel® 82559 Ethernet LAN controller (fully integrated 10Base-T/100Base-TX).
- Supports Wake-on-LAN remote control function.
- PCI Bus Master complies with PCI Rev. 2.1.
- MAC & PHY (10/100 Mbps) interfaces.
- Complies to IEEE 802.3 10Base-T and IEEE 802.3u 100Base-T interfaces.
- Fully supports 10Base-T and 100Base-TX operation.
- Single RJ-45 connector gives auto-detection of 10 Mbps or 100 Mbps network data transfer rates and connected cable types.
- 32-bit Bus Master technology complies with PCI Rev. 2.1.
- Plug and Play.
- Enhancements on ACPI & APM.
- Complies with PCI Bus Power Management Interface Rev. 1.0, ACPI Rev. 1.0, and Device Class Power Management Rev. 1.0.

6.3 Installation

Note: Before installing the LAN drivers, make sure the CSI utility has been installed in your system. See Chapter 4 for information on installing the CSI utility.

The PCA-6180's onboard Ethernet interface supports all major network operating systems. However, the installation procedure varies with different operating systems. In the following sections, refer to the one that provides driver setup procedure for the operating system you are using.

6.4 Windows 95/98/2000 Drivers Setup Procedure

Note: The CD-ROM drive is designated as "D" throughout this section.

1. From the desktop of Windows 95/98/2000, click on "Start" and select "Settings." Then click on the "Control Panel" icon to select "System."

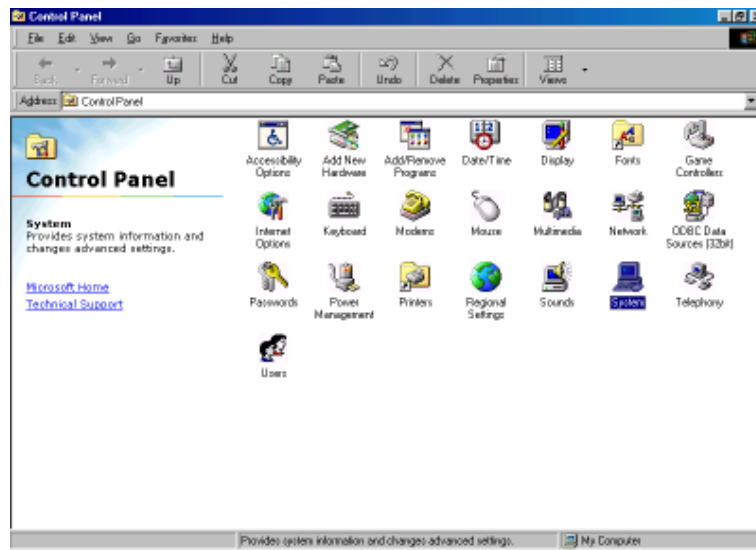

2. In the "System Properties" window, select the "Device Manager" tab. Select "View devices by type," and navigate to: Computer\Other devices. Highlight "PCI Ethernet Controller" and click on "Properties."

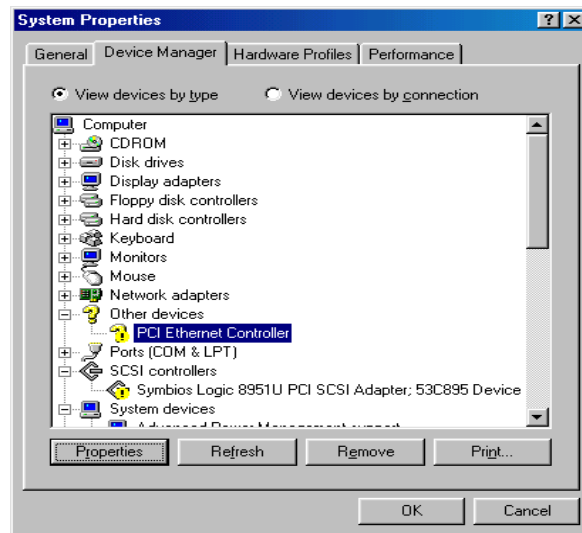

3. In the "PCI Ethernet Controller Properties" window, select the "Driver" tab. Then click on "Update Driver..."



4. In the "Update Device Driver Wizard" window, click on "Next."



5. In the "Update Device Driver Wizard" window, select "Search for a better driver than the one your device is using now. (Recommended)." Then click on "Next."



6. In the following "Update Device Driver Wizard" window, click on "Browse."

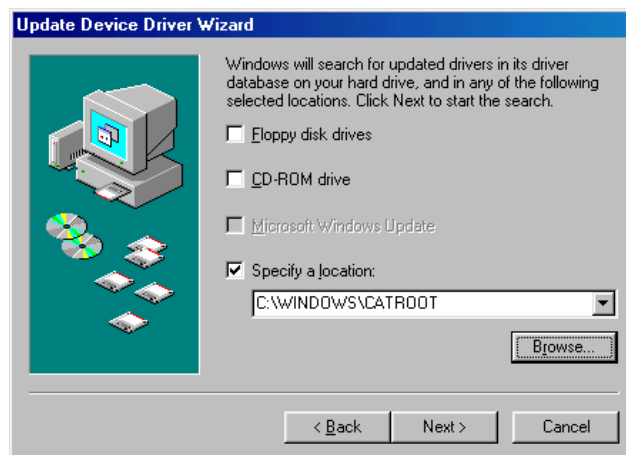

7. In the "Browse for Folder" window, navigate to the CD-ROM drive and click on the "82562" folder. Then click on "OK."

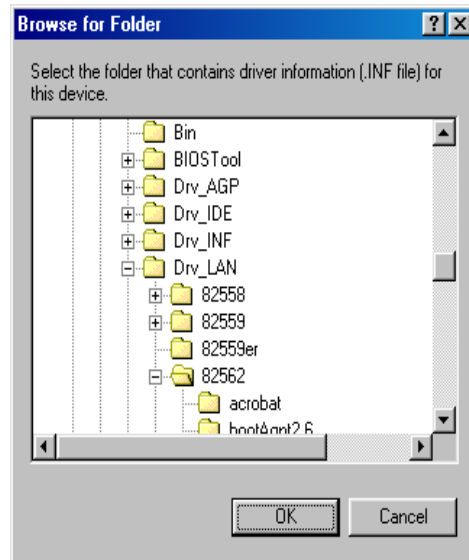

8. In the following "Update Device Driver Wizard" window, click on "Next."

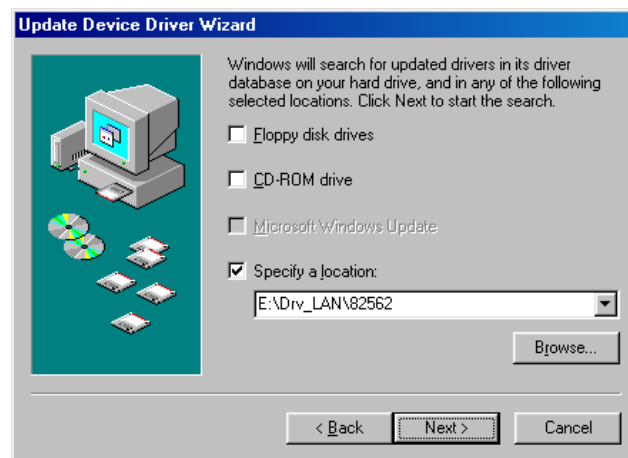

9. In the following "Update Device Driver Wizard" window, click on "Next."

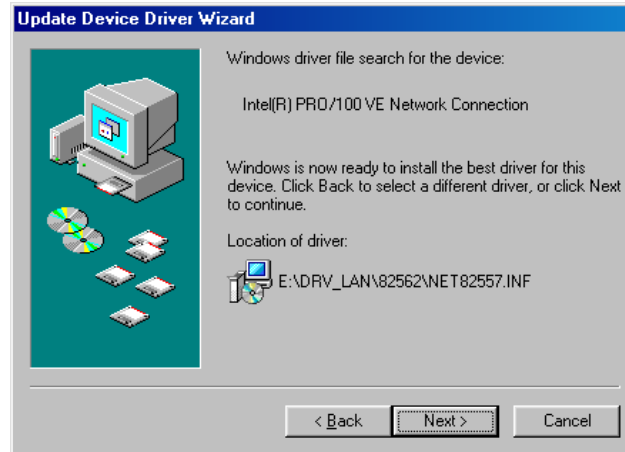

10. In the following "Update Device Driver Wizard" window, click on "Finish."

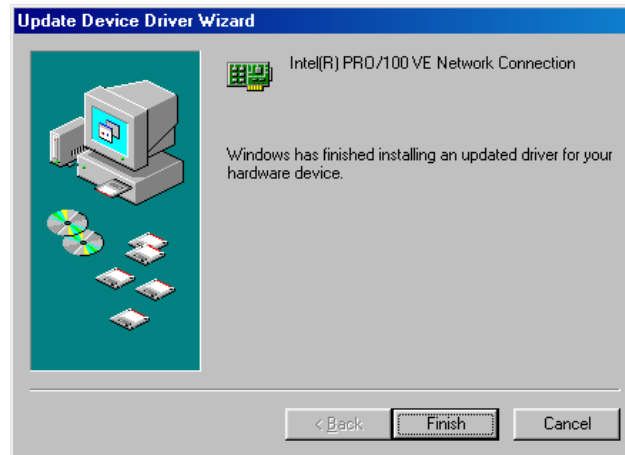

11. In the "System Settings Change" window, click on "Yes" to complete the installation and restart Windows.

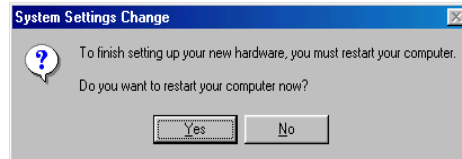

6.5 Windows NT Drivers Setup Procedure

Note: The CD-ROM drive is designated as "D" throughout this section.

1. From the desktop of Windows NT, click on "Start" and select "Settings." Then click on the "Control Panel" icon to select "System."

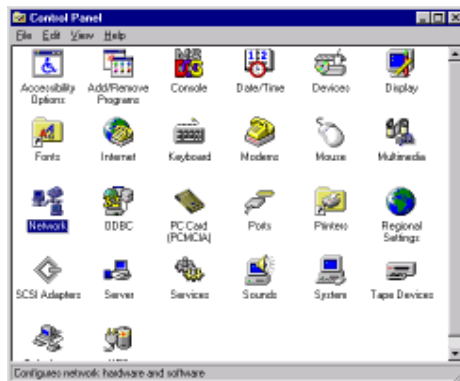

2. In the "Network" window, select the "Adapters" tab. Then click on "Add..."

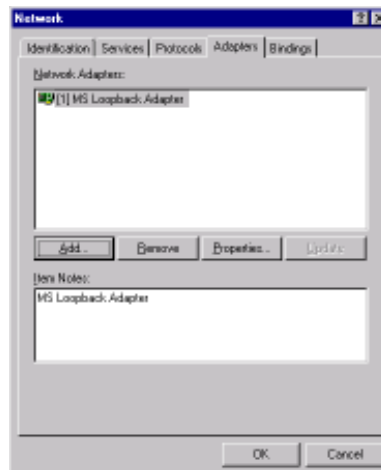

3. In the "Select Network Adapter" window, click on "Have Disk..."



4. When the "Insert Disk" window appears, insert the driver CD into the CD-ROM drive and type in "d:\drv_lan\82562." When you have the correct file path, click on "OK."

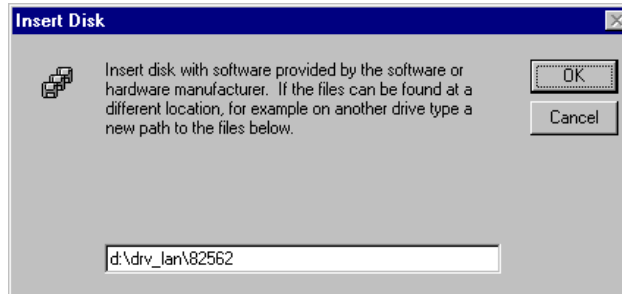

5. In the "Select OEM Option" window, click on "OK."

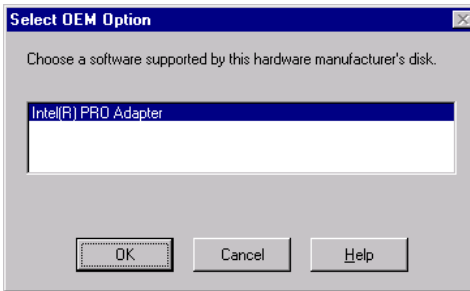

6. In the "Network" window, select the "Adapters" tab. Under "Network Adapters," highlight "[2] Intel(R) PRO/100+ Management Adapter" and "[3] Intel(R) PRO/100 VE Network Connection." Then click on "Close."

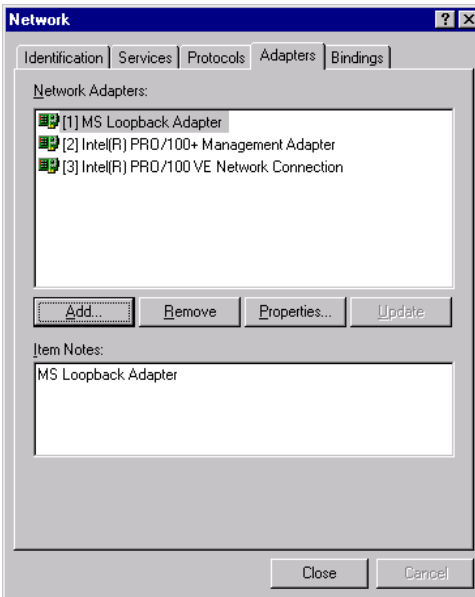

6.6 Windows 98SE/ME Drivers Setup Procedure

Note: The CD-ROM drive is designated as "D" throughout this section.

For computers using Windows 98SE or Windows ME, the operating system will automatically install the "Intel(R) Pro/100+ Management Adapter" driver the first time it detects the LAN device. If your CPU card has two Ethernet ports and you are experiencing problems with LAN connections (one of the ports does not work) after you have installed drivers for both LANs, perform the following steps to correct the problem.

1. From the desktop of Windows 98SE/ME, click on "Start" and select "Settings." Then click on the "Control Panel" icon to select "System."

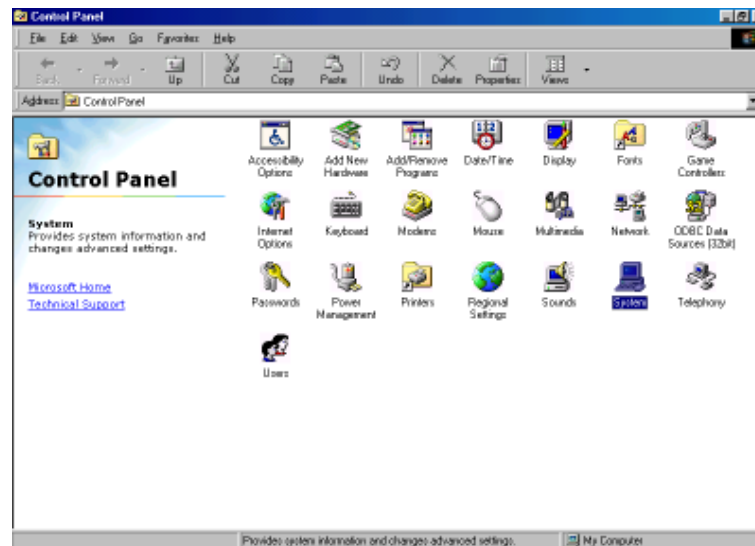

2. In the "System Properties" window, select the "Device Manager" tab. Select "View devices by type," and navigate to: Computer\Network adapters. Highlight "Intel(R) PRO/100+ Management Adapter" and click on "Properties."

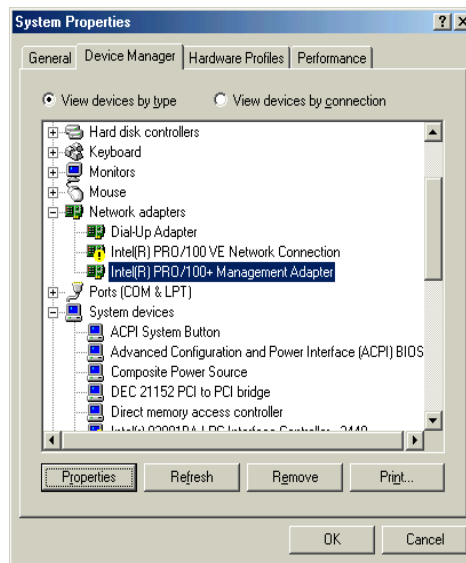

3. In the "Intel(R) PRO/100+ Management Adapter Properties" window, select the "Driver" tab. Then click on "Update Driver..."

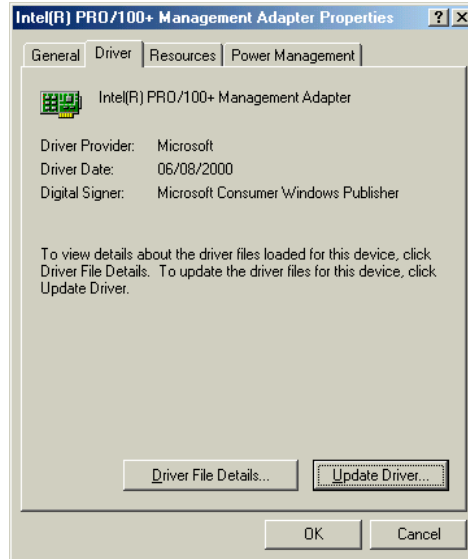

4. In the "Update Device Driver Wizard" window, click on "Specify the location of the driver (Advanced)" and then click on "Next."



5. In the following "Update Device Driver Wizard" window, select "Search for a better driver than the one your device is using now. (Recommended)." Select "Specify a location:" and then click on "Browse."



6. In the "Browse for Folder" window, navigate to the CD-ROM drive and click on the "82562" folder. Then click on "OK."

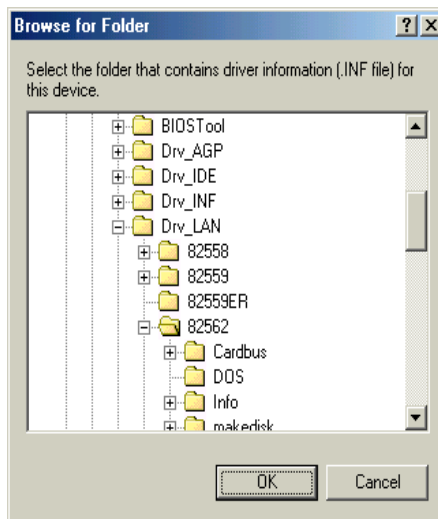

7. In the following "Update Device Driver Wizard" window, click on "Next."

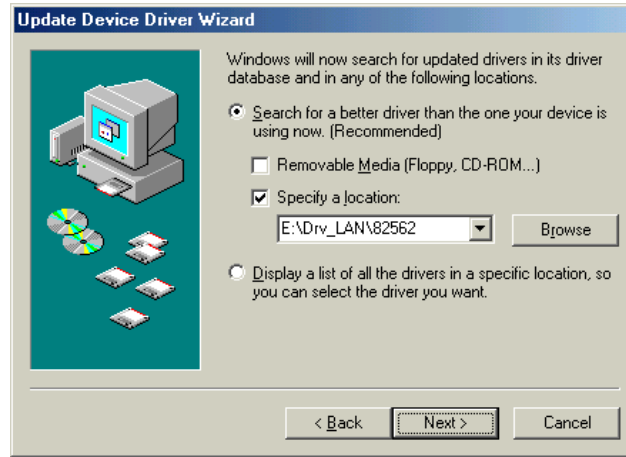

9. In the following "Update Device Driver Wizard" window, click on "Next."



10. In the following "Update Device Driver Wizard" window, click on "Next."

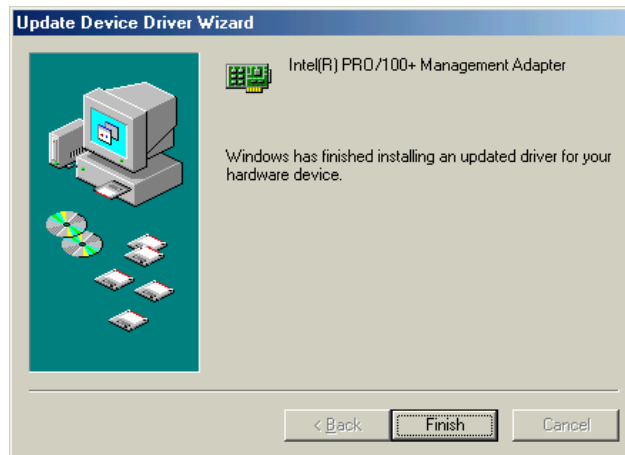

11. In the "System Settings Change" window, click on "Yes" to complete the installation and restart Windows.

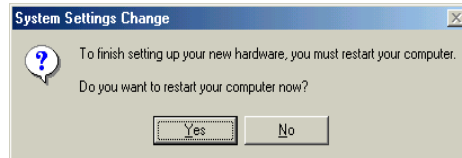

6.7 Windows NT Wake-on-LAN Setup Procedure

1. From the desktop of Windows NT, click on "Start" and select "Settings." Then click on the "Control Panel" icon to select "System."



2. In the "Intel(R) PROSet" window, under "Select a Network Adapter," choose "[2] Intel(R) PRO100+ Management Adapter." Then select the "Advanced" tab. Under "Setting," highlight the "Enable PME" item. Under "Value," select "Enabled." Then click on "OK."

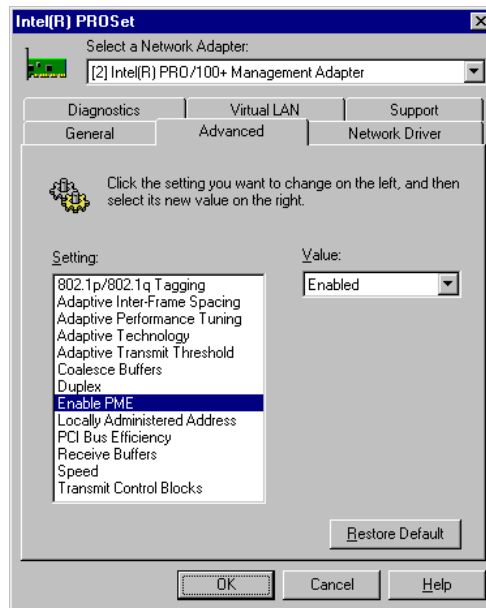

3. In the "Reboot Required" window, click on "Yes."

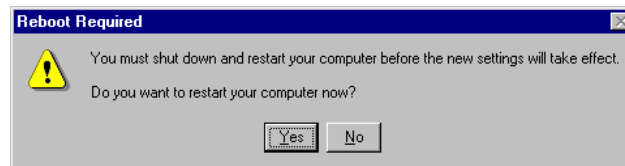

CHAPTER 7

Ultra ATA 100 Storage Driver Setup

This driver must be installed to use the Intel® Ultra ATA controller to improve storage subsystem performance and overall system performance.

7.1 Introduction

This driver takes advantage of the latest Intel® Ultra ATA controller features to improve both storage subsystem performance and overall system performance. A useful diagnostic tool, Intel Ultra ATA Companion®, shows technical information of the ATA subsystem.

7.2 Features

- The driver enables fast Ultra ATA transfers by default.
- Users no longer have to manually enable DMA transfers for each ATA and/or ATAPI peripheral devices.
- Each ATA channel has independent device timings/transfers which allows PIO-only and DMA-capable devices to share the same ATA controller cable, where one is the master and the other the slave, without restricting transfer mode to PIO-only for both devices.
- Technical details of the ATA subsystem can be viewed via use of the application.
- Drivers are optimized.

7.3 Installation

Note: Before installing this driver, make sure the CSI utility has been installed in your system. See Chapter 4 for information on installing the CSI utility.

1. Insert the driver CD into your system's CD-ROM drive. In a few seconds, the software installation main menu appears, as shown in the following figure. Under the "IDE DRIVERS" heading, click on the "Auto" button.



2. Click on "Next" when you see the following message.



3. When you see the following message, click on "Yes" to accept the License Agreement.

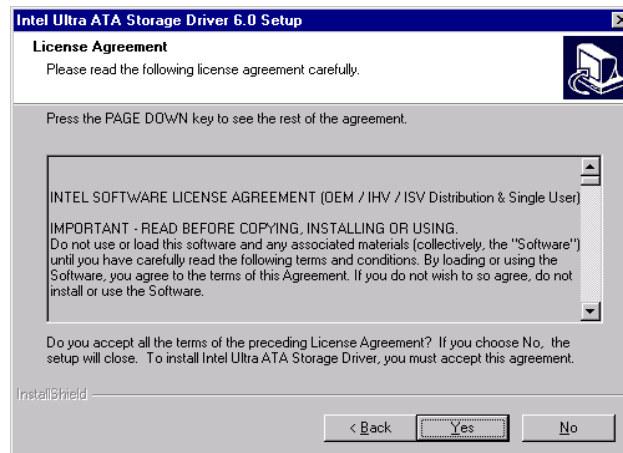

4. Click on "Next" when you see the following message.

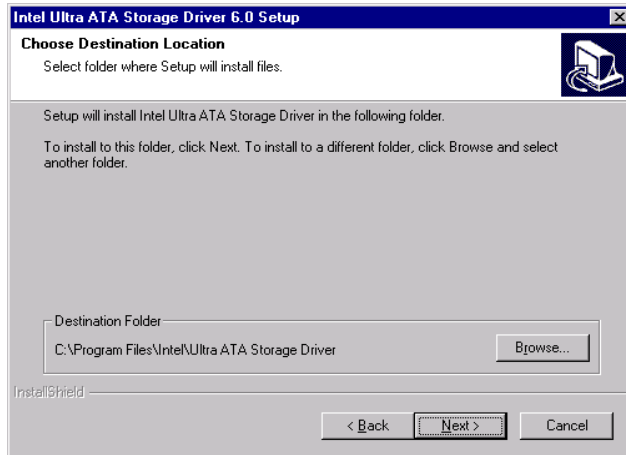

5. Click on "Next" when you see the following message.

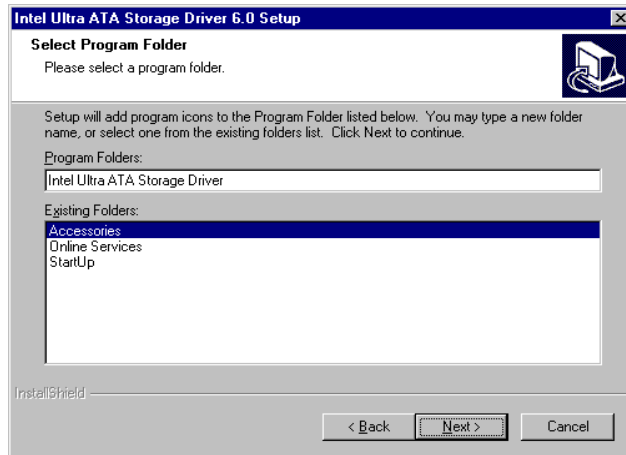

6. When the following message appears, click "Finish" to complete the installation and restart Windows.

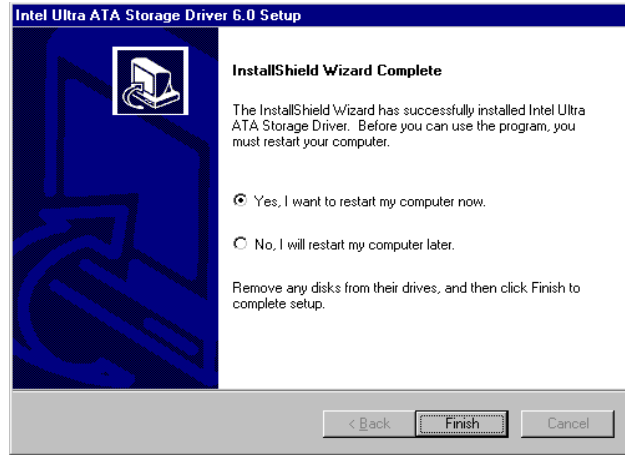

7.4 Displaying Driver Information

1. From the desktop of Windows, click on "Start" and select "Programs." Then select "Intel Ultra ATA Storage Driver" and then "Companion."

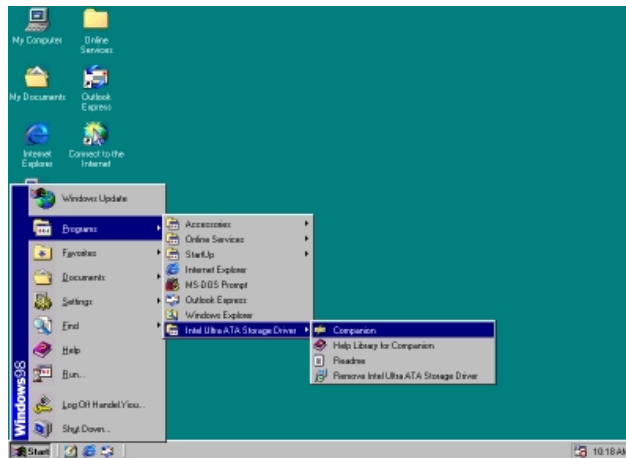

2. Click on the "Device Parameters" or the "Storage Report" tab to view related information.

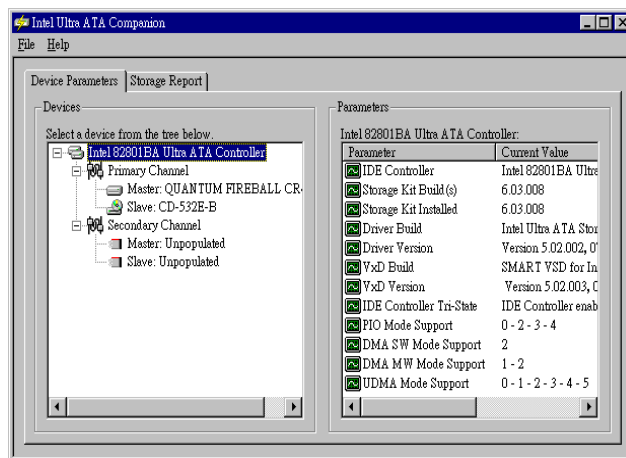

CHAPTER 8

Onboard Security Setup

This chapter explains OBS concepts and provides instructions for installing the relevant software drivers. This is done using the driver CD included in your PCA-6180 package.

8.1 Introduction

Onboard security (OBS) functions monitor key hardware. They help you maintain your system's stability and durability.

The PCA-6180 can monitor 5 sets of system positive voltages, 2 sets of system negative voltages, CPU cooling fan speed, and CPU temperature.

The positive system voltage sets which can be monitored include:

- CPU core voltage: 1.3 V ~ 3.3 V, according to Intel specifications.
- Transmission voltage from CPU to chipset: typically 1.5 V.
- Chipset voltage: typically 3.3 V.
- Main voltage: +5 V, +12 V.

The negative system voltage sets which can be monitored include:

- Main voltage: -5 V, -12 V.

8.2 Installation

Note: Before installing the LAN drivers, make sure the CSI utility has been installed in your system. See Chapter 4 for information on installing the CSI utility.

The installation procedure varies with different operating systems. In the following sections, refer to the one that provides driver setup procedure for the operating system you are using.

8.3 Windows 9X Drivers Setup Procedure

1. Insert the driver CD into your system's CD-ROM drive. In a few seconds, the software installation main menu appears, as shown in the following figure. Click on the "WIN 9X" button under the "OBS DRIVERS" heading.



2. When you will see the following message, make sure you have closed all other programs, then click on "OK."



3. Click on the square graphics button when you see the following message.

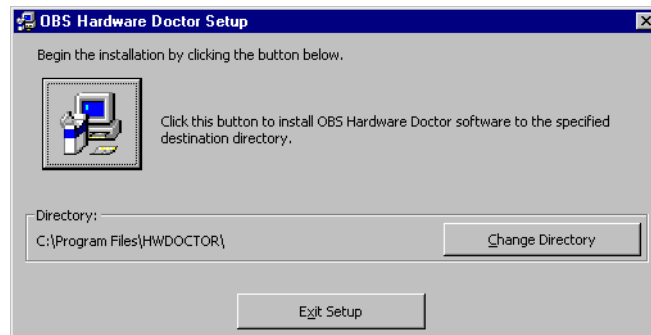

4. When you see the following message, click on "OK" to complete the installation..

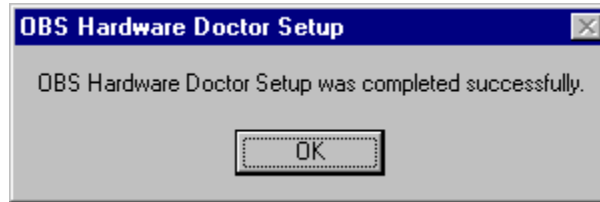

8.4 Windows NT Drivers Setup Procedure

1. Insert the driver CD into your system's CD-ROM drive. In a few seconds, the software installation main menu appears, as shown in the following figure. Click on the "WIN NT" button under the "OBS DRIVERS" heading.



2. Click "Next" when you see the following message.



3. Click "Next" when you see the following message.



4. Click "Next" when you see the following message.

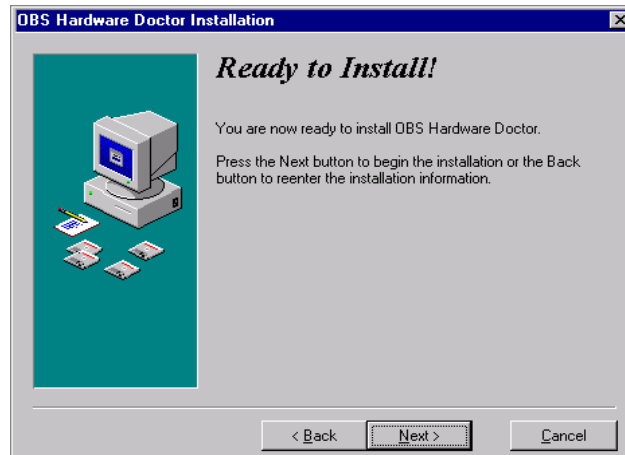

5. Click "Finish" when you see the following message.

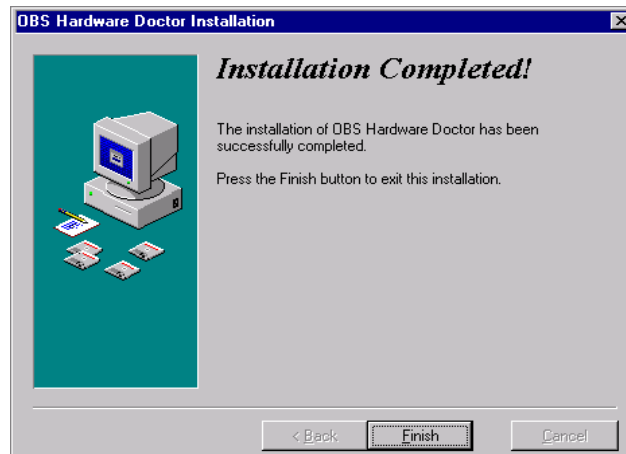

6. Click "OK" to restart Windows.

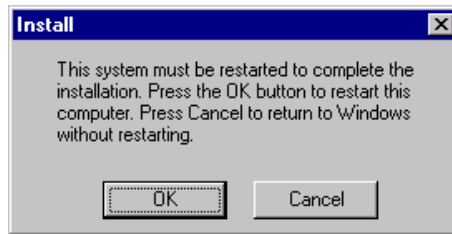

8.5 Using the OBS Hardware Doctor Utility

After completing the setup, all the OBS functions are permanently enabled. When a monitored reading exceeds safe limits, a warning message will be displayed and an error beep tone will activate to attract your attention.

OBS Hardware Doctor will show an icon on the right side of the bottom window bar. This icon is the "Terminate and Stay Resident" (TSR) icon. It will permanently remain in the bottom window bar, and will activate warning signals when triggered by the onboard security system.

You can view or change values for various OBS settings by running this utility:

1. From the desktop of Windows, click on "Start" and select "Programs" and then "OBS Hardware Doctor."

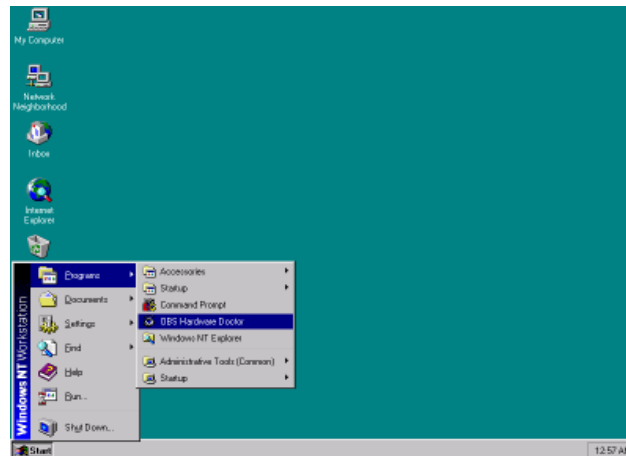

- It is recommended that you load the default values for all the OBS settings. However, if desired, you can establish new conditions for voltage, fan speed, and temperature.

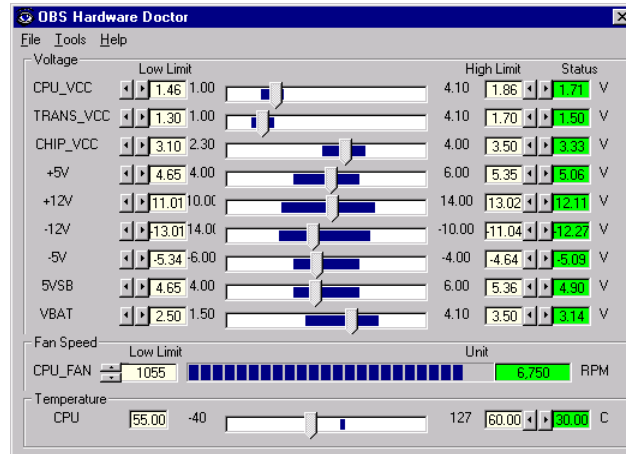

APPENDIX

A

Programming the Watchdog Timer

The PCA-6180 is equipped with a watchdog timer that resets the CPU or generates an interrupt if processing comes to a standstill for any reason. This feature ensures system reliability in industrial standalone or unmanned environments.

A.1 Programming the Watchdog Timer

The PCA-6180's watchdog timer can be used to monitor system software operation and take corrective action if the software fails to function after the programmed period. This section describes the operation of the watchdog timer and how to program it.

A.1.1 Watchdog timer overview

The watchdog timer is built-in the super I/O controller W83627HF. It provides the following functions for user programming:

- Can be enabled and disabled by user's program.
- Timer can be set from 1 to 255 seconds or 1 to 255 minutes.
- Generates an interrupt or resets signal if the software fails to reset the timer after time-out.

A.1.2 Reset/ Interrupt selection

The J2 jumper is used to select reset or interrupt (IRQ 11) in the event the watchdog timer is tripped. See Chapter 1 for detailed jumper settings.

Note: *The interrupt output of the watchdog timer is a low level signal. It will be held low until the watchdog timer is reset.*

A1.3 Programming the Watchdog Timer

The I/O port address of the watchdog timer is 2E(hex) and 2F(hex).

2E (hex) is the address port. 2F(hex) is the data port.

You must first assign the address of register by writing address value into address port 2E(hex), then write/read data to/from the assigned register through data port 2F (hex).

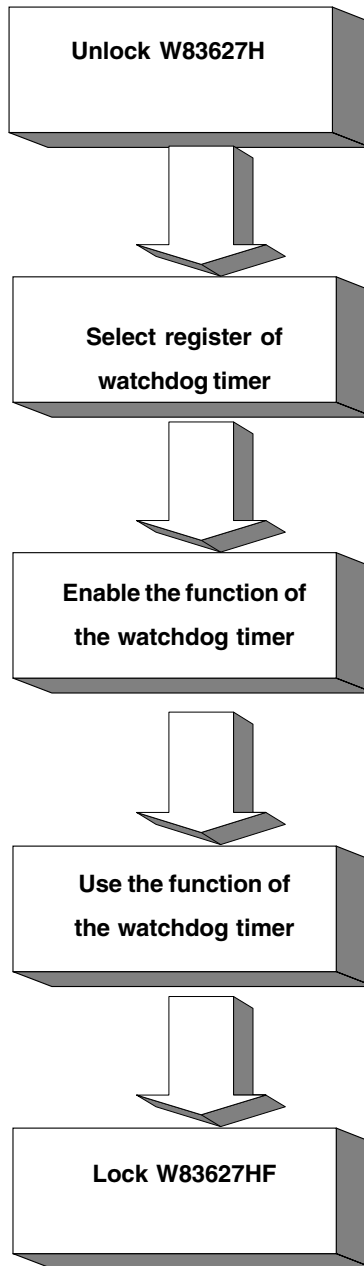

Watchdog Timer Registers		
Address of register (2E)	Attribute Read/Write	Value (2F) and description
87 (hex)	-----	Write this address to I/O address port 2E (hex) twice to unlock the W83627HF
07 (hex)	write	Write 08 (hex) to select register of watchdog timer.
30 (hex)	write	Write 01 (hex) to enable the function of the watchdog timer. Disabled is set as default.
F5 (hex)	write	Set seconds or minutes as units for the timer. Write 0 to bit 3: set second as counting unit. [default] Write 1 to bit 3: set minute as counting unit
F6 (hex)	write	0: stop timer [default] 01~FF (hex): The amount of the count, in seconds or minutes, depends on the value set in register F5 (hex). This number decides how long the watchdog timer waits for strobe before generating an interrupt or reset signal. Writing a new value to this register can reset the timer to count with the new value.
F7 (hex)	read/write	Bit 7: Write 1 to enable mouse to reset the timer, 0 to disable [default] Bit 6: Write 1 to enable keyboard to reset the timer, 0 to disable. [default] Bit 5: Write 1 to generate a timeout signal immediately and automatically return to 0. [default=0] Bit 4: Read status of watchdog timer, 1 means timer is "time out".
AA (hex)	-----	Write this address to I/O port 2E (hex) to lock the watchdog timer.

Table A-1: Watchdog timer registers

A.1.4 Example Program

1. Enable watchdog timer and set 10 sec. as timeout interval

```
-----  
Mov dx,2eh           ; Unlock W83627HF  
Mov al,87h  
Out dx,al  
Out dx,al  
-----  
Mov al,07h          ; Select registers of watchdog timer  
Out dx,al  
Inc dx  
Mov al,08h  
Out dx,al  
-----  
Dec dx              ; Enable the function of watchdog timer  
Mov al,30h  
Out dx,al  
Inc dx  
Mov al,01h  
Out dx,al  
-----  
Dec dx              ; Set second as counting unit  
Mov al,0f5h  
Out dx,al  
Inc dx  
In al,dx  
And al,not 08h  
Out dx,al  
-----  
Dec dx             ; Set timeout interval as 10 seconds and start counting
```



```

Mov al,0f6h
Out dx,al
Inc dx
Mov al,10
Out dx,al
;-----
Dec dx ; lock W83627HF
Mov al,0aah
Out dx,al
2. Enable watchdog timer and set 5 minutes as timeout interval
;-----
Mov dx,2eh ; unlock W83627H
Mov al,87h
Out dx,al
Out dx,al
;-----
Mov al,07h ; Select registers of watchdog timer
Out dx,al
Inc dx
Mov al,08h
Out dx,al
;-----
Dec dx ; Enable the function of watchdog timer
Mov al,30h
Out dx,al
Inc dx
Mov al,01h
Out dx,al
;-----
Dec dx ; Set minute as counting unit
Mov al,0f5h

```

```

Out dx,al
Inc dx
In al,dx
Or al,08h
Out dx,al
;-----
Dec dx ; Set timeout interval as 5 minutes and start counting
Mov al,0f6h
Out dx,al
Inc dx
Mov al,5
Out dx,al
;-----
Dec dx ; lock W83627HF
Mov al,0aah
Out dx,al
3. Enable watchdog timer to be reset by mouse
;-----
Mov dx,2eh ; unlock W83627H
Mov al,87h
Out dx,al
Out dx,al
;-----
Mov al,07h ; Select registers of watchdog timer
Out dx,al
Inc dx
Mov al,08h
Out dx,al
;-----
Dec dx ; Enable the function of watchdog timer
Mov al,30h

```

```

Out dx,al
Inc dx
Mov al,01h
Out dx,al
;-----
Dec dx          ; Enable watchdog timer to be reset by mouse
Mov al,0f7h
Out dx,al
Inc dx
In al,dx
Or al,80h
Out dx,al
;-----
Dec dx          ; lock W83627HF
Mov al,0aah
Out dx,al
4. Enable watchdog timer to be reset by keyboard
;-----
Mov dx,2eh     ; unlock W83627H
Mov al,87h
Out dx,al
Out dx,al
;-----
Mov al,07h     ; Select registers of watchdog timer
Out dx,al
Inc dx
Mov al,08h
Out dx,al
;-----
Dec dx          ; Enable the function of watchdog timer
Mov al,30h

```

```

Out dx,al
Inc dx
Mov al,01h
Out dx,al
;-----
Dec dx          ; Enable watchdog timer to be strobed reset by keyboard
Mov al,0f7h
Out dx,al
Inc dx
In al,dx
Or al,40h
Out dx,al
;-----
Dec dx          ; lock W83627HF
Mov al,0aah
Out dx,al
5. Generate a time-out signal without timer counting
;-----
Mov dx,2eh      ; unlock W83627H
Mov al,87h
Out dx,al
Out dx,al
;-----
Mov al,07h      ; Select registers of watchdog timer
Out dx,al
Inc dx
Mov al,08h
Out dx,al
;-----
Dec dx          ; Enable the function of watchdog timer
Mov al,30h

```

```

Out dx,al
Inc dx
Mov al,01h
Out dx,al
;-----
Dec dx ; Generate a time-out signal
Mov al,0f7h
Out dx,al ;Write 1 to bit 5 of F7 register
Inc dx
In al,dx
Or al,20h
Out dx,al
;-----
Dec dx ; lock W83627HF
Mov al,0aah
Out dx,al

```

APPENDIX **B**

Pin Assignments

This appendix contains information of a detailed or specialized nature. It includes:

- IDE Hard Drive Connector
- Floppy Drive Connector
- Parallel Port Connector
- SCSI Connector
- USB Connector
- VGA Connector
- Ethernet 10/100Base-T RJ-45 Connector
- COM1/COM2 RS-232 Serial Port
- Keyboard and Mouse Connector
- External Keyboard Connector
- IR Connector
- CPU Fan Power Connector
- Power LED and Keylock Connector
- External Speaker Connector
- Reset Connector
- HDD LED Connector
- ATX Feature Connector
- ATX Soft Power Switch
- H/W Monitor Alarm
- SM Bus Connector
- Extension I/O Board Connector
- PS/2 Mouse Connector
- System I/O Ports
- DMA Channel Assignments
- Interrupt Assignments
- 1st MB Memory Map

B.1 IDE Hard Drive Connector (CN1, CN2)

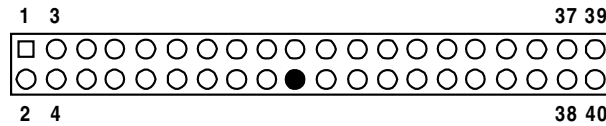

Table B-1: IDE hard drive connector (CN1, CN2)

Pin	Signal	Pin	Signal
1	IDE RESET*	2	GND
3	DATA 7	4	DATA 8
5	DATA 6	6	DATA 9
7	DATA 5	8	DATA 10
9	DATA 4	10	DATA 11
11	DATA 3	12	DATA 12
13	DATA 2	14	DATA 13
15	DATA 1	16	DATA 14
17	DATA 0	18	DATA 15
19	SIGNAL GND	20	N/C
21	DISK DMA REQUEST	22	GND
23	IO WRITE	24	GND
25	IO READ	26	GND
27	IO CHANNEL READY	28	GND
29	HACKO*	30	GND
31	IRQ14	32	N/C
33	ADDR 1	34	N/C
35	ADDR 0	36	ADDR 2
37	HARD DISK SELECT 0*	38	HARD DISK SELECT 1*
39	IDE ACTIVE*	40	GND

* low active

B.2 Floppy Drive Connector (CN3)

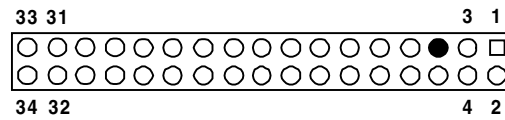

Table B-2: Floppy drive connector (CN3)

Pin	Signal	Pin	Signal
1	GND	2	FDHDIN*
3	GND	4	N/C
5	N/C	6	FDEDIN*
7	GND	8	INDEX*
9	GND	10	MOTOR 0*
11	GND	12	DRIVE SELECT 1*
13	GND	14	DRIVE SELECT 0*
15	GND	16	MOTOR 1*
17	GND	18	DIRECTION*
19	GND	20	STEP*
21	GND	22	WRITE DATA*
23	GND	24	WRITE GATE*
25	GND	26	TRACK 0*
27	GND	28	WRITE PROTECT*
29	GND	30	READ DATA*
31	GND	32	HEAD SELECT*
33	GND	34	DISK CHANGE*

* low active

B.3 Parallel Port Connector (CN4)

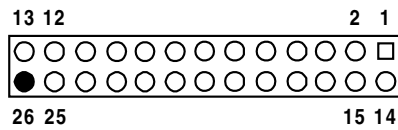

Table B-3: Parallel port connector (CN4)

Pin	Signal	Pin	Signal
1	STROBE*	14	AUTOFD*
2	D0	15	ERR
3	D1	16	INIT*
4	D2	17	SLCTINI*
5	D3	18	GND
6	D4	19	GND
7	D5	20	GND
8	D6	21	GND
9	D7	22	GND
10	ACK*	23	GND
11	BUSY	24	GND
12	PE	25	GND
13	SLCT	26	N/C

* low active

B.4 SCSI Connector (CN5)

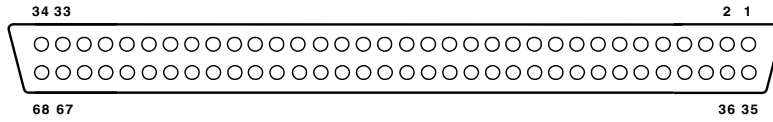

Table B-4: SCSI connector (CN5)

Pin	Function	Pin	Function
1	SD+12	35	SD-12
2	SD+13	36	SD-13
3	SD+14	37	SD-14
4	SD+15	38	SD-15
5	SDP+1	39	SDP-1
6	SD+0	40	SD-0
7	SD+1	41	SD-1
8	SD+2	42	SD-2
9	SD+3	43	SD-3
10	SD+4	44	SD-4
11	SD+5	45	SD-5
12	SD+6	46	SD-6
13	SD+7	47	SD-7
14	SDP+0	48	SDP-0
15	GND	49	GND
16	DIFS	50	SENIN
17	TPWEX	51	TPWEX
18	TPWEX	52	TPWEX
19	NC	53	NC
20	GND	54	GND
21	SATN+	55	SATN-
22	GND	56	GND
23	SBSY+	57	SBSY-
24	SACK+	58	SACK-
25	SRST+	59	SRST-
26	SMSG+	60	SMSG-
27	SSEL+	61	SSEL-
28	SCD+	62	SCD-
29	SREQ+	63	SREQ-
30	SIO+	64	SIO-
31	SD+8	65	SD-8
32	SD+9	66	SD-9
33	SD+10	67	SD-10
34	SD+11	68	SD-11

B.5 USB Connector (CN6)

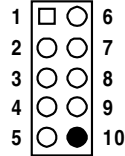

Table B-5: USB1/USB2 connector (CN6)

Pin	USB1 Signal	Pin	USB2 Signal
1	+5 V	6	+5 V
2	UV-	7	UV-
3	UV+	8	UV+
4	GND	9	GND
5	Chassis GND	10	N/C

B.6 VGA Connector (CN7)

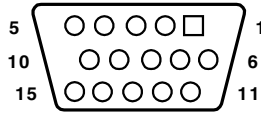

Table B-6: VGA connector (CN7)

Pin	Signal	Pin	Signal
1	RED	9	V _{CC}
2	GREEN	10	GND
3	BLUE	11	N/C
4	N/C	12	SDT
5	GND	13	H-SYNC
6	GND	14	V-SYNC
7	GND	15	SCK
8	GND		

B.7 Ethernet 10/100Base-T RJ-45 Connector (CN8, CN34)

Table B-7: Ethernet 10/100Base-T RJ-45 connector (CN8, CN34)

Pin	Signal	Pin	Signal
1	XMT+	5	N/C
2	XMT-	6	RCV-
3	RCV+	7	N/C
4	N/C	8	N/C

B.8 COM1/COM2 RS-232 Serial Port (CN9, CN10)



Table B-8: COM1/COM2 RS-232 serial port (CN9, CN10)

Pin	Signal
1	DCD
2	RXD
3	TXD
4	DTR
5	GND
6	DSR
7	RTS
8	CTS
9	RI

B.9 Keyboard and Mouse Connector (CN11)

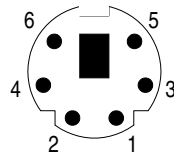

Table B-9: Keyboard and mouse connector (CN11)

Pin	Signal
1	KB DATA
2	MS DATA
3	GND
4	V_{CC}
5	KB CLOCK
6	MS CLOCK

B.10 External Keyboard Connector (CN12)

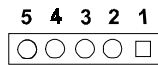

Table B-10: External keyboard connector (CN12)

Pin	Signal
1	CLK
2	DATA
3	NC
4	GND
5	V_{CC}

B.11 IR Connector (CN13)

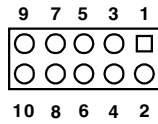

Table B-11: IR connector (CN13)

Pin	Signal	Pin	Signal
1	+5 V	2	N/C
3	FIRRX	4	CIRRX
5	IR_RX	6	+5VSB
7	GND	8	N/C
9	IR_TX	10	N/C

B.12 CPU Fan Power Connector (CN14)



Table B-12: CPU fan power connector (CN14)

Pin	Signal
1	GND
2	+12 V
3	Detect

B.13 Power LED and Keylock Connector (CN16)

You can use an LED to indicate when the CPU card is on. Pin 1 of CN16 supplies the LED's power, and Pin 3 is the ground.

You can use a switch (or a lock) to disable the keyboard so that the PC will not respond to any input. This is useful if you do not want anyone to change or stop a program which is running. Simply connect the switch from Pin 4 to Pin 5 of CN16.

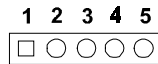

Table B-13: Power LED and keylock connector (CN16)

Pin	Function
1	LED power (+5 V)
2	NC
3	GND
4	Keyboard lock
5	GND

B.14 External Speaker Connector (CN17)

The CPU card has its own buzzer. You can also connect it to the external speaker on your computer chassis.

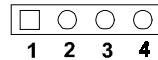

Table B-14: External speaker (CN17)

Pin	Function
1	+5 V _{cc}
2	GND
3	Internal buzzer
4	Speaker out

B.15 Reset Connector (CN18)



Table B-15: Reset connector (CN18)

Pin	Signal
1	RESET
2	GND

B.16 HDD LED Connector (CN19)



Table B-16: HDD LED connector (CN19)

Pin	Signal
1	LED0 (LED-)
2	Vcc(LED+)

B.17 ATX Feature Connector (CN20)



Table B-17: ATX feature connector (CN20)

Pin	Signal
1	PS-ON
2	V _{CC}
3	V _{CC} SB

B.18 ATX Soft Power Switch (CN21)



Table B-18: ATX soft power switch (CN21)

Pin	Signal
1	5VSB
2	PWR-BTN

B.19 H/W Monitor Alarm (CN22)

Table B-19: H/W monitor alarm (CN22)

Pin	Signal
1	V _{cc} (LED+)
2	LED0 (LED-)

B.20 SM Bus Connector (CN23)



Table B-20: ATX soft power switch (CN21)

Pin	Signal
1	SMB_CLK
2	SMB_DATA

B.21 Extension I/O Board Connector (CN27)

Table B-21: Extension I/O board connector (CN27)

Pin	Signal	Pin	Signal
1	D+ (USB3)	11	D- (USB1)
2	D+ (USB2)	12	D- (USB0)
3	D- (USB3)	13	Vcc (USB1)
4	D- (USB2)	14	Vcc (USB0)
5	Vcc (USB3)	15	GND (USB1)
6	Vcc (USB2)	16	GND (USB0)
7	GND (USB3)	17	5VSB
8	GND (USB2)	18	ACT LED (LAN2)
9	D+ (USB1)	19	LINK (LAN 2)
10	D+ (USB0)	20	SPEED-100Mbps (LAN 2)

B.22 Extension I/O Board Connector (CN28)

Table B-22: Extension I/O board connector (CN28)

Pin	Signal	Pin	Signal
1	TXC+ (DVI)	11	TX0+ (DVI)
2	TXC- (DVI)	12	TX0- (DVI)
3	FP_SDAT (DVI)	13	TXD+ (LAN2)
4	FP_SCLK (DVI)	14	GND
5	H_DEC (DVI)	15	RXIN+ (LAN2)
6	FP_VCC (DVI)	16	TXD- (LAN2)
7	TX2+ (DVI)	17	MS DATA (PS/2 MS)
8	TX2- (DVI)	18	RXIN- (LAN2)
9	TX1+ (DVI)	19	MS CLOCK (PS/2 MS)
10	TX1- (DVI)	20	MS_VCC (PS/2 MS)

B.23 PS/2 Mouse Connector (CN33)

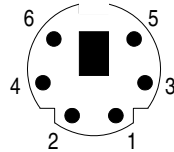

Table B-23: PS/2 mouse connector (CN33)

Pin	Signal
1	MS DATA
2	N/C
3	GND
4	V_{cc}
5	MS CLOCK
6	N/C

B.24 System I/O Ports

Table B-24: System I/O ports

Addr. range (Hex)	Device
000-01F	DMA controller
020-021	Interrupt controller 1, master
022-023	Chipset address
040-05F	8254 timer
060-06F	8042 (keyboard controller)
070-07F	Real-time clock, non-maskable interrupt (NMI) mask
080-09F	DMA page register
0A0-0BF	Interrupt controller 2
0C0-0DF	DMA controller
0F0	Clear math co-processor
0F1	Reset math co-processor
0F8-0FF	Math co-processor
1F0-1F8	Fixed disk
200-207	Game I/O
278-27F	Parallel printer port 2 (LPT3)
290-297	On-board hardware monitor
2F8-2FF	Serial port 2
300-31F	Prototype card
360-36F	Reserved
378-37F	Parallel printer port 1 (LPT2)
380-38F	SDLC, bisynchronous 2
3A0-3AF	Bisynchronous 1
3B0-3BF	Monochrome display and printer adapter (LPT1)
3C0-3CF	Reserved
3D0-3DF	Color/graphics monitor adapter
3F0-3F7	Diskette controller
3F8-3FF	Serial port 1
443	Watchdog timer

B.25 DMA Channel Assignments

Table B-25: DMA channel assignments

Channel	Function
0	Available
1	Available
2	Floppy disk (8-bit transfer)
3	Available
4	Cascade for DMA controller 1
5	Available
6	Available
7	Available

B.26 Interrupt Assignments

Table B-26: Interrupt assignments

Priority	Interrupt#	Interrupt source
1	NMI	Parity error detected
2	IRQ0	Interval timer
3	IRQ1	Keyboard
-	IRQ2	Interrupt from controller 2 (cascade)
4	IRQ8	Real-time clock
5	IRQ9	Cascaded to INT 0A (IRQ 2)
6	IRQ10	Available
7	IRQ11	Available
8	IRQ12	PS/2 mouse
9	IRQ13	INT from co-processor
10	IRQ14	Fixed disk controller
11	IRQ15	Available
12	IRQ3	Serial communication port 2
13	IRQ4	Serial communication port 1
14	IRQ5	Parallel port 2
15	IRQ6	Diskette controller (FDC)
16	IRQ7	Parallel port 1 (print port)

B.27 1st MB Memory Map

Table B-27: 1st MB memory map

Addr. range (Hex)	Device
F0000h - FFFFFh	System ROM
C8000h - EFFFFh	Unused
C0000h - C7FFFh	VGA BIOS
B8000h - BFFFFh	CGA/EGA/VGA text
B0000h - B7FFFh	Unused
A0000h - AFFFFh	EGA/VGA graphics
00000h - 9FFFFh	Base memory

B.28 PCI Bus Map

Table B-28: PCI bus map

Function	Signals: Device ID	INT# pin	GNT# pin
Onboard LAN1	AD24	INT E	
Onboard LAN2	AD21	INT H	GNT A
Onboard SCSI	AD20	INT A	GNT E
Bridge	AD22		GNT F
PCI slot 1	AD31	INT B, C, D, A	GNT A
PCI slot 2	AD30	INT C, D, A, B	GNT B
PCI slot 3	AD29	INT D, A, B, C	GNT C
PCI slot 4	AD28	INT A, B, C, D	GNT D

Note: In the PCA-6180E2/F, SCSI devices use "GNT A" signals via PCI slot 1. Therefore, PCI slot 1 cannot be used for plug-in bus master add-on cards such as SCSI cards or LAN cards.