

Level, Flow and Ph Controls & Indicators, Flow Switches, Sensors, Bin Aerators, PH Sensors, Bulk Solid Emission Monitors, Automated Two-Piece Stainless Ball Valves.

There are also Product type and Manufacturer indexes in the back of the catalog.

*This catalog is just an overview designed to help you locate and narrow down solutions as quickly as possible.*

**For complete specs, part numbers and pricing, or if you can't find what you need, please call AA Electric inside sales at 1-800-237-8274 or visit  [AAElectricOnline.com](http://AAElectricOnline.com) or send us an e-mail from the "Contact us" section. You will automatically reach the nearest office. We will be glad to help!**

Product Type	Manufacturer	Beginning Page
Conductivity Liquid Level Controls	ABB SSAC	12/2
Float Switches, Liquid Level Alarms & Monitors	Anchor Scientific / RotoFloat	12/3
Conductivity Liquid Level Controls	Curtis	12/6
Level Controls & Sensors: Electro-Optic, Float, Conductance, Conductivity, High Purity, Multi-point, Ultrasonic, Transmitters, Indicators & Receivers. Flow Switches & Sensors, Intrinsically Safe Relays & Controls	Gems	12/7
Flow & PH Sensors, Transmitters, Monitors, Controllers, & Totalizers	+GF+Signet	12/12
Bulk Solid Point & Continuous Level Monitors, Controls, Emission Monitors, Solids Flow Monitors, Bin Aeration Devices	Monitor	12/28
Sanitary and Non-Sanitary Flow Monitors & Switches, Capacitive and Ultrasonic Level Sensors (see Section 1), Probe Sensors Inline Flow Sensors, Solid-State Flow Monitors	Turck	12/30

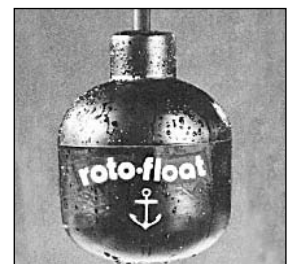

### Other Items you may need and related Section Number

- Capacitive & Ultrasonic Sensors, Section 1
- Motor/ Pump Controls & Protection, Section 2
- Speed Controls, Softstarts and Motors, Section 3
- Enclosures, Corrosion Protection & Wiring Aids, Section 6
- Terminal & Power Distribution Blocks, Fuses & Holders, Section 7
- Relays & Sockets, Section 8
- Pushbuttons, Switches & Miniature Lamps, Section 9
- Industrial PLCs, Computers, I/O, Networking, Interfaces, Section 10
- Panel Meters, Process Temperature, Pressure & Signal Conditioning, Recorders, Test Equipment, Section 11
- Cables, Cordsets, & Connectors, Section 13
- Power Supplies, Transformers, UPSs, Section 15
- Alarms, Audible & Visual, Section 16

**AA Electric – Your single source for machine control and automation specialty products.**



## Important Safety Warning...Please Read!



Many products do NOT include the self-checking redundant circuitry necessary to allow their use in personnel safety applications, and should never be used as devices for personnel protection. Their use as safety devices may create an unsafe condition which could lead to serious bodily injury or death. A component failure or malfunction can result in either an energized or a deenergized output condition.

Only certain products (many are in Safety Section 14) that are so designated are designed to meet OSHA and ANSI machine safety standards for point-of-operation guarding devices. Sensors or controls that do not meet these standards must NOT be used as sensing devices for personnel protection. Please contact AA Electric for more information on point-of-operation guarding devices.



## Liquid Level Control LLC5 Series Dual Probe



10 YEAR WARRANTY

- Dual Probe Level Control for Conductive Liquids
- Onboard Knob or Fixed Sensing up to 100K $\Omega$
- Fill or Drain Operation Available
- LED Indicator Reduces Adjustment Time
- 120 V AC Input Voltage
- 5 A SPDT Isolated Contacts

### Description

The LLC5 provides dual level control in a convenient octal plug-in package. Models are available for fill or drain operation. Transformer isolated AC voltage on the probes prevents electrolytic plating. Less than 1 mA of current is used to sense the presence of conductive liquid between the probes and common. On adjustable units, the sensitivity adjustment eliminates false tripping caused by floating debris and foaming agents.

### Operation

**Drain (Pump Down Mode):** When the liquid level rises and touches the high level probe, the output relay energizes and remains energized until the liquid level falls below the low level probe. The output relay then de-energizes and remains de-energized until the liquid again touches the high level probe.

**Fill (Pump Up Mode):** When the liquid level falls below the low level probe, the output relay energizes and remains energized until the liquid level rises and touches the high level probe. The output relay then de-energizes and remains de-energized until the liquid level again falls below the low level probe.

- Approvals:

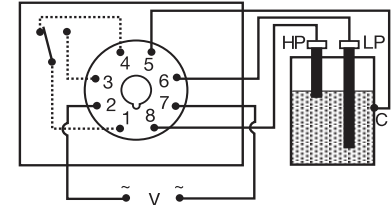

Relay contacts are isolated. Dashed lines are internal connections.

Connect common to conductive tank. Additional probe is necessary for non-conductive or insulated tanks.

HP = High Level Probe LP = Low Level Probe  
C = Probe Common V = Voltage

### Liquid Level Control Electrodes and Probes



\$28.81 Each  
UL recognized

### Description

Composed of an alumina insulator and metal parts made of number 300 series nonmagnetic stainless steel. These internally conductive glass-sealed electrodes are capable of up to 2500 PSI at 2°C and 37°C at 1 atmosphere.

Input Voltage	Operation	Sensitivity	Part Number	Price Each
120 V AC	Drain	Adjustable	LLC54AA	\$ 42.42
120 V AC	Fill	Adjustable	LLC54BA	\$ 42.42
230 VAC	Drain	Adjustable	56 AA	\$ 42.42
230 VAC	Fill	Adjustable	56 BA	\$ 42.42

Also Available for 24 V AC, 230 V AC and with Fixed Sensitivity

### Technical Data

Control	
Type	Resistance sensing for high & low level detection of conductive liquids
Sense Voltage	12 V AC at probe terminals
Sense Resistance	Factory fixed or adjustable to 100K $\Omega$
Sense Resistance Tolerance	Adjustable - guaranteed range Factory fixed +/-10%
Input	
Voltage	120 V AC
Tolerance	120 & 230 V AC -20% ... +10%
Frequency	50 ... 60 Hz
Output	
Type	Electromechanical relay
Form	Isolated single pole double throw (SPDT) contacts
Rating	5 A resistive at 240 V AC; 1/10 hp at 240 V AC
Protection	
Isolation Voltage	$\geq$ 1500 V RMS between input, output, & probe
Mechanical	
Mounting	Plug-in socket
Termination	8-Pin plug-in
Environmental	
Operating Temperature	-20°C ... +60°C

### Screw-in bar electrodes

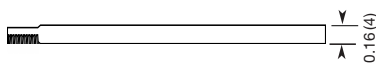

Part Number	Length	\$ Each
1SVR 450 056 R 0000	12 in. (300 mm)	\$ 10.00
1SVR 450 056 R 0100	24 in. (600 mm)	\$ 11.00
1SVR 450 056 R 0200	39 in (1000 mm)	\$ 12.00

### Overhead electrode + rubber grommet



Bar electrodes (X 12 CR Mo S 17) with sleeve (Lupulen 6011 L, suitable up to max. 60°C)

P/N 1SVR 402 902 R 0000 \$16 Each

Note: The terminal of the electrode should be sealed to prevent corrosion. Protects electrode cables from thunderstorms.

### Compact Support

Part Number	Type	Description	\$ Each
1SVR 450 056 R 6000	CM-KH-3	Compact support for 3 bar electrodes	\$ 44.00
1SVR 450 056 R 7000	CM-AH-3	Distance plate for 3 bar electrodes	\$ 5.00
1SVR 450 056 R 8000	CM-GM-1	Counternut for 1" thread	\$ 7.00

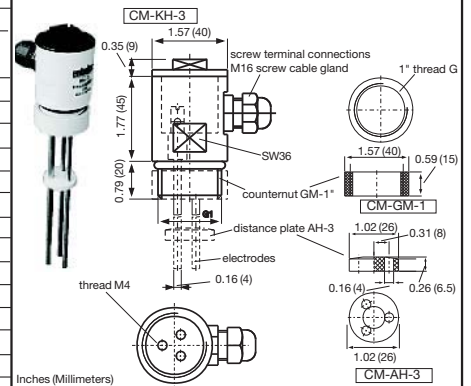

### Accessories

<p>Panel mount kit P/N: BZ1</p> <p>\$7.49 Each</p>	<p>Octal 8-pin socket P/N: NDS 8</p> <p>\$3.33 Each</p>
<p>Level probe P/N: LLP 24</p> <p>\$9.61 Each</p>	<p>Hold down clips P/N: PSC8</p> <p>\$3.68 Each</p>
<p>Electrode with common connection P/N: WCC 1138 3</p> <p>\$33.72 Each</p>	<p>Electrode P/N: WCC 1138</p> <p>\$28.81 Each</p>

## roto-float TYPE S - SUSPENDED



Priced From \$47.00

The ROTO-FLOAT is a direct acting float switch. Each ROTO-FLOAT contains a single pole mercury switch which actuates when the longitudinal axis of the float is horizontal, and deactuates when the liquid level falls 1" below the actuation elevation.

The float is a chemical resistant polypropylene casing with a firmly bonded electrical cable protruding. One end of the cable is permanently connected to the enclosed mercury switch and the entire assembly is encapsulated to form a completely watertight and impact resistant unit. Type S - Suspended has built-in weight.

ROTO-FLOATS can be mounted on a support pipe (type P) or suspended from above (type S). Advantages of the ROTO-FLOAT are low cost, simplicity and reliability.



**Listed**

- Pilot Duty
- Industrial Control Equipment

**CABLE**

P.V.C. type STO #18 conductors (41 strand) rated 600 volts

- Various lengths available
- See table of models
- Non-standard lengths also available on special order.

Switch Arrangement	Cable Length	Suspended Type S Model No.	Ship Wt.
Normally Open	20	S20NO	4#
	30	S30NO	4 1/2#
	40	S40NO	5 1/4#
Normally Closed	20	S20NC	4#
	30	S30NC	4 1/2#
	40	S40NC	5 1/4#



Priced From \$47.00

## roto-float TYPE P - PIPE MOUNTED



Priced From \$47.00

The ROTO-FLOAT is a direct acting float switch. Each ROTO-FLOAT contains a single pole mercury switch which actuates when the longitudinal axis of the float is horizontal, and deactuates when the liquid level falls 1" below the actuation elevation.

The float is a chemical resistant polypropylene casing with a firmly bonded electrical cable protruding. One end of the cable is permanently connected to the enclosed mercury switch and the entire assembly is encapsulated to form a completely water tight and impact resistant unit.

ROTO-FLOATS can be mounted on a support pipe (type P) or suspended from above (type S). Advantages of the ROTO-FLOAT are low cost, simplicity and reliability.



**Listed**

- Pilot Duty
- Industrial Control Equipment

**CABLE**

P.V.C. type STO #18 conductors (41 strand) rated 600 volts

- Various lengths available
- See table of models
- Non-standard lengths also available on special order

**MATERIALS OF CONSTRUCTION**

Float housing.....Polypropylene  
 Cable clamp.....Polypropylene  
 Cable jacket.....P.V.C.

Switch Arrangement	Cable Length	Suspended Type S Model No.	Ship Wt.
Normally Open	20	P20NO	2#
	30	P30NO	2 3/4#
	40	P40NO	3 1/2#
Normally Closed	20	P20NC	2#
	30	P30NC	2 3/4#
	40	P40NC	3 1/2#





## eco·float MODEL G

### Features

- Mercury Free
- Variety of Mounting Styles
- Variety of Circuit Configurations
- Installation Easy
- Differential In One Float
- Replaces Diaphragm and Mercury Switches

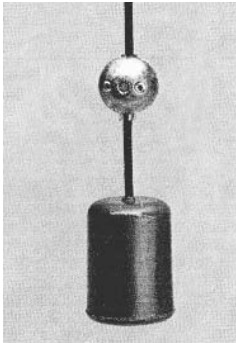

Priced from \$27.50

### Description

The Eco-float is a mercury-free float switch for controlling liquid levels in a variety of applications. A snap-action switch is activated by a steel ball rolling back and forth within a switching tube in a plastic float housing. There is a minimum differential between "on" and "off" of approximately 3.5 inches. Greater differentials can be achieved when the pipe mounted or externally weighted mounting styles are used. Various lengths of cable and circuit configurations are available and in stock.

### Applications

The Eco-Float can be used in a variety of liquid level monitoring applications including sumps, sewage ejectors, septic tanks, vaults, lift stations, and tanks. Eco-Floats are ruggedly constructed of corrosion resistant materials, enabling them to be used in a variety of different liquids. Some applications are subject to additional requirements described in the National Electric Code.

### Specifications

Cable	18-2 or 18-3 SJO W/A, 60 C., 41 x 34 stranding dia. - . 29(18-2); .31(18-3)
Float Housing	Polypropylene Dim: 3.0D x 4.25
Electrical Ratings	7A. @ 115 VAC; 3.5A @ 230 VAC
Clamp	Polypropylene, (Model GP)
External Weight	Lead, 300 series stainless steel (Model GSE)
Temp. Limit	140° F

### Ordering Information

Specify:	
Model	G
Mounting Style	SE (external weight) SI (internal weight) P (pipe mounted)
Cable Length	10, 15, 20, 30, 40, 50 Custom lengths available
Circuit Configuration	NO (normally open) NC (normally closed) NONC (normally open/ normally closed)

### Example

GSI 20NO - Eco-Float, suspended internal wt. 20', normally open contacts.

## solo·float

### FEATURES

- Reliability
- Adjustable Pumping Range
- Manual Operation
- Non-mercury Element
- Converts Non-automatic Pumps To Automatic
- Replaces Diaphragm Pressure Switches
- Easy Installation
- In Stock, Low Cost



Priced from \$28.00

### DESCRIPTION

The new Solo-Float" is a direct acting float switch for controlling 1 1/2 HP and smaller pump motors. The new Solo-Float has been completely redesigned and uses a metal ball rolling back and forth in a tube to actuate a reliable, snap-action switch. An adjustable, plastic clamp with stainless steel hose clamp is provided for attaching the Solo-Float at the appropriate level on the pump discharge pipe. By varying the tether length, a pumping range of 8" - 14" can be achieved. The Solo-Float is available with a piggyback plug in either a 115 volt or 230 volt configuration. It is also available blunt cut, without a plug, for wiring to an Anchor Scientific JX junction box.

### APPLICATIONS

The Solo-Float can be used in a variety of liquid level applications, including sumps, sewage ejectors, septic tanks, vaults and tanks. The corrosion resistance of the materials used in its construction also make the Solo-Float a good choice for many corrosive applications.

### Example

D	20	NO	115
Model	Cable	Circuit	Plug
Type	Length	Config.	Style
Standard Models			
D	10	NO	115
	15	NC	230
	20		-(Blunt)
	30		

### SPECIFICATIONS

Cable	16-2, SJO W/A, 60° C. Dia. - .32 65 Strands x #34
Float Housing	Polypropylene. Dim 5.0" x 3.0" D. Blue - Normally Open Red - Normally Closed
Clamp	Polyethylene Pipe/Cable Clamp, Stainless Steel Hose Clamp, Range: 3/4" - 3"
Electrical Rating	1/2 HP @ 115V, Single Phase 1 1/2 HP @ 230V, Single Phase UL 508 Ind. Con. Eq.

### ORDERING INFORMATION

Three variables must be specified when ordering SoloFloats: 1.) Cable Length 2.) Circuit configuration. 3.) Plug Voltage. Cable lengths are available in 5 foot increments from 10' to 30". Consult factory for longer lengths. The circuit configuration is either 'NO', normally open, (pump down); or 'NC', normally closed, (pump up). The plug voltage also must be specified: '115' for 115 volt or '230' for 230 volt applications.

## Models LCS/LHS

Two sensitivity ranges for detection up to 3,000,000 ohms

### FEATURES

- Low cost Model LCS for Standard Applications up to 100,000 ohms
- High-Sensitivity Model LHS for Special Applications from 100,000 to 3,000,000 ohms
- Solid-State Amplifier with Potentiometer for Signal Sensitivity Adjustment
- Positive ON/OFF Operation Eliminates Relay Chatter
- Circuit Limits Short Circuit Probe Current to 10MA/24VAC
- Holding Circuit for Differential Levels, or Manual Reset
- Pre-Wired Auxiliary Contactor Available for Handling Heavy Loads and Motor Ratings Exceeding Capacity of Plug-In Relay

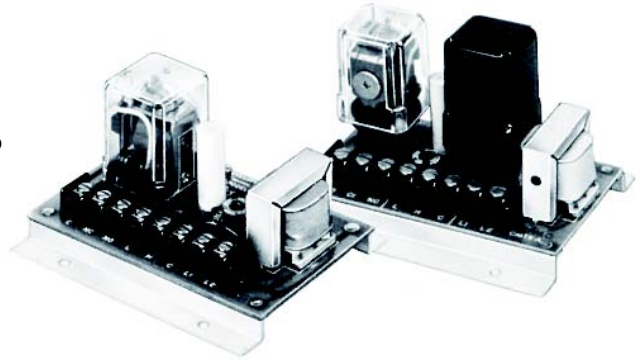

### SPECIFICATIONS

Input Supply:	Model	\$ Each	Input Supply
	LCS-10/LHS-1	\$86.00	120VAC, 50/60 Hz
	LCS-20/LHS-2	\$86.00	240VAC, 50/60 Hz
	LCS-30	\$86.00	24VAC, 50/60 Hz

Maximum Allowable Supply Voltage Variation:  $\pm 10\%$

Maximum Power Consumption: 3 Watts

Detectable Range: Up to 100,000 ohms (LCS); Up to 3,000,000 ohms (LHS)

Adjustable Range: 1,000 to 100,000 ohms (LCS); 1,000 to 3,000,000 ohms (LHS)

Operating Point Differential: 3% (Typical)

Signal or Probe Voltage: 24VAC

Maximum Signal or Probe Current: 10MA

Short Circuit Probe Current: 10MA

Control Relay: Plug-in type with dust cover

Probe Contacts: Internally Connected for Holding Circuit

Load Contacts: LCS – SPDT, 1/4 HP, 10 amp Non-inductive, 120VAC 1/3 HP at 240 VAC LHS – SPDT, 1/6 HP, 10 amp Non-inductive, 120VAC 1/3 HP at 240VAC

Auxiliary Contactor: DPST-NO-DB, rated 1 HP at 120VAC, 2 HP at 240VAC

Ambient Operating Temperature: +32° F to +140° F

Standard Termination: Barrier-type terminal blocks accepting wire up to No. 12AWG. Auxiliary contactor has combination screw/double .250" quick-connects

Mounting Style: Flange

## P Series

Probes for almost any pressure/temperature requirement

Five basic probe types and 14 model variations provide design versatility matched to your specific application. Choose from single, dual or multi-probe designs in PVC or nylon fittings. All probes feature 316 stainless steel electrodes with standard lengths ranging up to six feet, in one-foot increments. Pressure/temperature limits range as high as 2500 lbs./700° F. Covered probes are offered for applications subject to unusually adverse environments or stringent safety codes.



**Model EP** \$55.00 Each

Economy probe designed for budget systems. Available in NPT sizes 3/4" (Single probe), 1" (Dual probe), 1-1/2" (Triple probe) with Nylon Hex fittings.



**Model SP** \$45.00 Each

Simple probe designed with adjustable probe length feature. Must be used with conductive container only. Available in probe size diameters of 1/8", 3/16" or 1/4" (i.e. SP125, SP187, SP250).



**Models HTPP - HTPGP** \$45.00 Each

High temperature, high pressure 3/8" NPT probe designed to withstand hydrostatic pressures to 2500 psi and temperatures to 700° F. Standard Model HTPP does not contain added threaded stud for common ground connection, when required specify HTPGP Model. Constructed from 18-8 non-magnetic stainless steel with alumina insulation.



**Model CP** \$130.00 Each

Covered Probe designed for high humidity environments. Probe headers are splash-proof and moisture-tight. Available in NPT fitting sizes 1-1/2" for dual probe systems and 2" for triple or quadruple probe systems.

# HOT products

## LEVEL SENSORS

**Mini Suresite**  
High Visibility  
Liquid Level  
Indicators Need  
No Power.



**ELS-1150**  
Smallest  
High Pressure  
Electro-Optic  
Switch Available

**ELS-900**  
Our Smallest  
Electro-Optic Switch –  
Approx. 1-1/4" Long.

**LS-3**  
3/4" Dia.  
Mini Float  
Switch



**LS-6** Side-mount  
Float Switch



**Series M**  
Tilt Float  
Switch



**XM/XT-800**  
Continuous  
Level Sensors.



**FiberSite** Fiber-Optic  
Switches



Ultrasonic Switches and  
Continuous Transmitters

## FLOW SENSORS

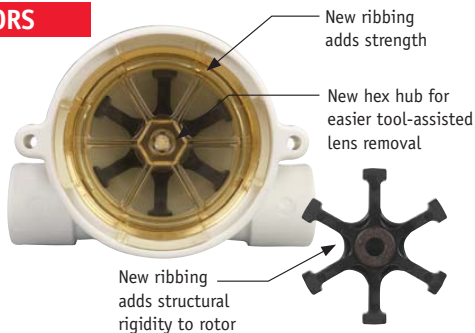

**New! FS-380P**  
Inline Plastic Flow Switch with NPT or  
Snap-on Port Connection Adapters



**New! FS-480**  
Stainless Steel Switch with  
Large 1/2" or 3/4" Ports for  
Low Pressure Drop

## PRESSURE SENSORS



All New Capacitance Transducers



**3100 Series**  
Compact, High Pressure  
OEM Pressure Transducers



All New PS Series Pressure Switches

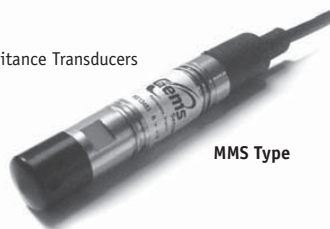

MMS Type

# COOL solutions

**SWITCHES**

## Electro-Optic Type

Industry's largest selection of electro-optic liquid level sensors is right here at Gems. So compact, we call them the "anyspace" sensors. Solid state-switching ensures dependability over long service life.

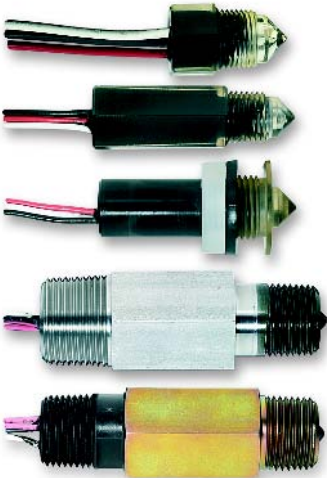

- Typical Applications**
- medical laboratory • food and beverage systems
  - machine tools • pharmaceuticals • petrochemicals
  - leak detection • hydraulic reservoirs



**SWITCHES**

## Float Types

Available in a vast range of sizes, mountings and materials, Gems offers the broadest selection of float-type level switches anywhere. Using a proven reed switch design, float type switches deliver long, trouble-free service with precise repeatability. They are available in both single point and multi-point configurations. Multi-point switches monitor up to six levels with a single unit; lengths from a few inches to 10 feet.

- Materials for All Fluids**
- Buna N • stainless steel • brass • PVC • CPVC • polysulfone
  - polypropylene • PVDF • Ryton® • Teflon®/PTFE • nylon



top or bottom mounting  
single point



**special purpose**

includes bent stems, slosh shields, temperature sensing, siphon tubes and many others

**SWITCHES**

## Conductance Type

The Silver Bullet™ liquid level sensor is the modern solution for nightmare fluid monitoring applications. Handles pressures to 2500 PSI and temperatures to 257°F! Features a solid state, compact uni-body design with integral electronic switching.



- Typical Applications**
- coolant level monitoring in radiators & expansion reservoirs
  - waste water level monitoring • leak detection
  - steam boilers • water level monitoring in oil separators



side mounting

multi-point

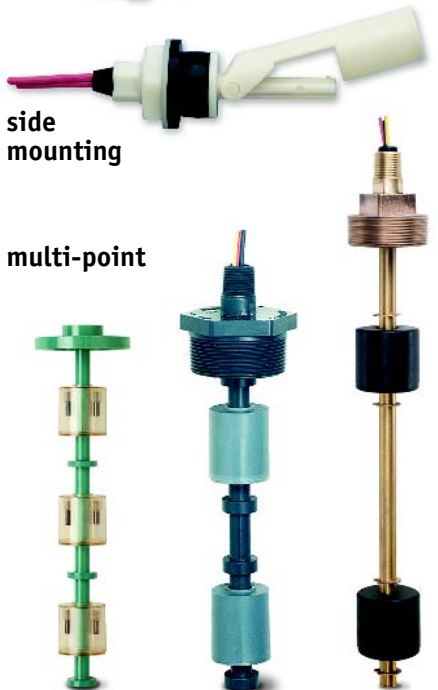

**SWITCHES**

## High Purity Types

Gems PureSense™ sensors are designed for ultra-pure fluid applications. PTFE and PVDF resist build-up of foreign material and sticky media. These high-purity level sensors come in single, multi-point, float and electro-optic types.



- Typical Applications**
- semiconductor processing equipment
  - pure chemical delivery systems
  - wafer cleaning and etching systems



## LEVEL SENSORS

### SWITCHES/TRANSMITTERS

#### Ultrasonic Types

Gems ultrasonic switches are ideal for applications requiring solid-state level measurement such as those with ultrapure, dirty, coating, scaling or corrosive-type liquids. Available in single point, multi-point up to four actuation levels or continuous measurement to 40 feet. Made of polypropylene, PVDF, PFA.



#### Typical Liquids

- acids • cooking oil • wastewater • slurries
- RO water • paints • lacquers • brine solutions • ink



### SWITCHES

#### Warrick® Conductivity

These single- or multi-point sensors have no moving parts. Stainless steel electrodes can be cut to desired length. Team with Gems conductivity controls to provide alarm, pump-up or pump-down control in electrically conductive liquids.

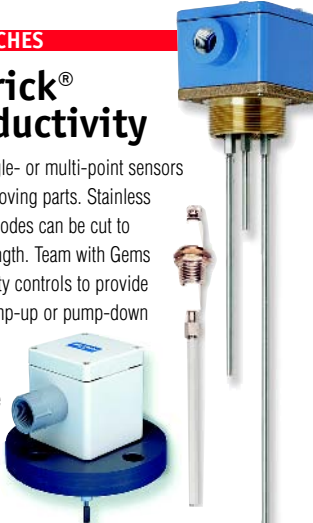

### TRANSMITTERS

#### Receivers

Your sensors know what's going on, but you're still in the dark without one of Gems receivers. Each receiver features all the calibration adjustments needed to complete a continuous level indication system.



compact level cuber and panel mounted receivers



### TRANSMITTERS

#### Float Types

Standard lengths offer measurement from a few inches to 18 feet. Choose from a variety of materials for mountings, stems and floats that includes PVC, polypropylene, PVDF, stainless steel, brass and Buna N. Signal conditioning provides outputs of 4-20 mA, 0-5 VDC and 0-12 VDC.

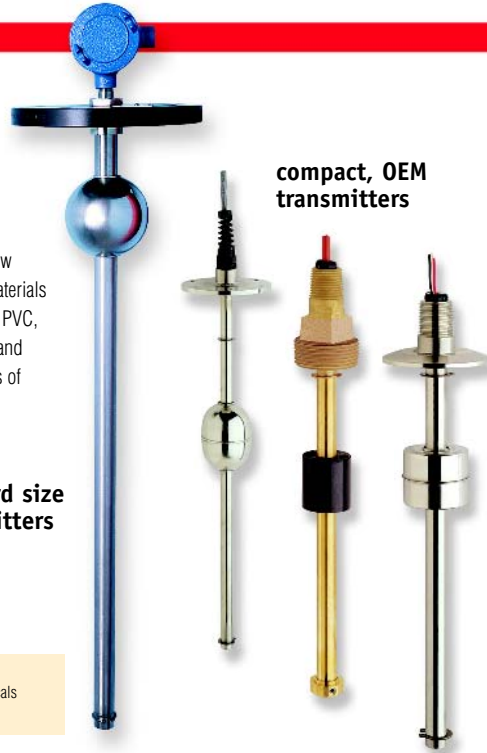

standard size transmitters

compact, OEM transmitters

#### Typical Applications

- utilities • beverage industry • medical • pharmaceuticals
- food processing • HVAC • semiconductor • OHV

### INDICATORS

#### DIPTAPE™ and DRUMTAPE™

Pop the cap, pull the tab—and up comes the tape to tell you exactly how much liquid remains in the tank or drum. Ideal for hazardous areas, DIPTAPE and DRUMTAPE indicators are non-electric, plus liquids and vapors remain sealed from the atmosphere. DIPTAPE indicators are designed for tanks; DRUMTAPE indicators fit 30 or 55 gallon storage drums.



DIPTAPE™ and DRUMTAPE™ in alloy, all-PVC and engineered plastic versions

### VISUAL LEVEL INDICATORS

#### SureSite®

The more durable—and safer—alternative to breakable sight glasses. SureSite visual level indicators feature stainless steel, alloy or engineered plastic housings; they mount externally to top or sides of tanks to provide easy-to-read, continuous level gauging. Magnetic flags flip to change color as an internal float moves with the liquid surface. Optional switches, transmitters and scales increase control capabilities.

#### Typical Advantages

- low maintenance • OSHA friendly • EPA friendly
- highly visible • rugged construction

standard and miniature series

in alloy and engineered plastic

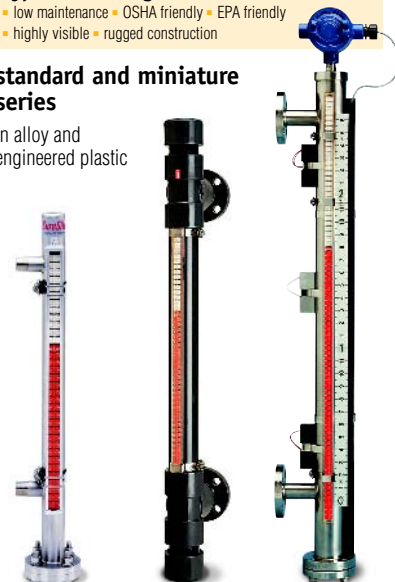

## SWITCHES

### Piston Type

Highly reliable and precision calibrated for liquids or gases. Fixed setpoints range from a low 50 cc/min to 1.5 GPM; adjustable version features setting of 0.5 to 20 GPM. Special capability versions offer viscosity compensation, and high pressure handling to 1,500 PSIG. Brass, plastic or stainless steel bodies.



#### Typical Applications

- laser heads • high-speed spindles • conveyors • robotics
- presses • regulators • distilling • water purification

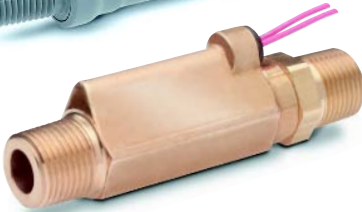

**instrument quality, piston actuated**

## SENSORS/INDICATORS

### Electronic Types

These highly visible, paddle wheel designs offer visual indication, flow rate sensing and switching. The visual indication is combined with a choice of either pulsed DC output 0-10V DC analog or adjustable 1 Amp switched output. Available with brass, stainless steel or hydrolytically-stable polypropylene housings. Line sizes: 1/4" to 1". Adjustable settings: 0.1 to 60 GPM.



**RotorFlow® sensors**



### FT-110 TurboFlow® sensor



## SWITCHES

### Paddle Type

Flow/No-Flow detection for pipes with 1-1/4" diameter and up. Paddles are cut to length for desired actuation setting (from 1-1/4" to 5-1/2"). Unique, patented cam design assures low pressure drop and does not require bellows, seals or mechanical linkages.

#### cut-to-length paddle switches for large pipes



#### Typical Applications

- compressors • heat exchangers • turbines • engines
- chillers • regulators

#### Typical Applications

- semiconductor processing equipment • lasers and welders
- X-ray and other high-power tubes • water injection systems
- chemical metering equipment • chillers and heat exchangers

## SWITCHES

### Shuttle Type

For monitoring water and oil in line sizes 1/2" to 3". Accurate with 1% repeatability and low-pressure drop. Plastic, bronze or stainless steel housings. Fixed settings from 0.5 to 100 GPM; adjustable settings from 0.75 to 15 GPM.



## SOLID STATE

### Intrinsically Safe Relays and Controls

Render any non-voltage-producing sensor, switch or conductivity electrode intrinsically safe with these relays and barriers from Gems. They amplify sensor load-handling capabilities in a wide range of AC and DC control switching applications. They are designed for easy installation in standard circuit boxes in non-hazardous areas. The amount of energy they send to sensors and switches within hazardous areas is insufficient to cause ignition of a specific hazardous atmospheric mixture in its most ignitable concentration.

In addition to safety, they offer great economy by reducing your need for costly explosion-proof sensors, switches, controls and housings. Solid-state reliability assures consistent performance, and with a completely encapsulated construction they are impervious to dust, moisture or foreign material. Select from a broad choice of SAFE-PAK® and Warrick models.



**SAFE-PAK® relays & Zener barriers**



**Warrick® Series 17/27/37 conductivity level control**

**Warrick® Series 47 4-channel relay alarm panel control**



#### Typical Applications

- hazardous atmospheres
- pumps
- waste treatment/sewage
- CP industry
- refineries
- fuel storage areas

## ELECTRICAL

### Standard and Custom Warrick® Panels

Gems Sensors manufactures both custom and standard control panels, bearing the safety mark of UL or CSA, for use in hazardous (UL 913) and non-hazardous (UL 508A) locations. We offer a complete selection of controls including electromechanical and solid-state relays, timers, alternators, motor starters, transformers, alarms, indicator lights and more.



**single- and multi-function control panels**



**RA-431 alarm panel**



**Model 2800 moisture detector**



**DMS-470/570 Series**

#### Typical Applications

- submersible pumps
- oil/water separator controls
- high or low alarms
- leak detection

## SOLID STATE

### Non-Intrinsically Safe Relays and Conductivity Level Controls

These relays boost your sensor's load handling ability in non-hazardous locations with the reliability and advantages inherent in solid-state controls. Available with plug-in bases, open board or threaded terminals.

**Warrick® Series 16M/26M**



#### Typical Applications

- single-level service
- differential service
- point level
- alarms
- valve control
- pump control
- low-water cutoff

## ELECTROMECHANICAL

### Warrick® Series 1 Controls

Offering two- or three-pole output contacts with 16 amp rating, these versatile controls can be configured for single-level service, differential control, low water cutoff (with manual reset or lock-out capability) control and many other functions.



#### Typical Applications

- on/off control
- pump control
- boiler level control
- boiler LLCO
- general purpose

## The Signet 8900

- One to six sensor inputs including Flow, pH, ORP, Conductivity, Pressure, Level, and Temperature.
- 1/4 DIN NEMA 4X Front
- AC or DC Power
- Up to four analog and eight relay outputs
- Ideally suited for RO/DI water systems, waste treatment applications, cooling towers, scrubbers and animal life support systems
- Simple wiring
- Intuitive menu operation
- Modular configuration for simple field upgrades
- Auto configuration - no unnecessary menus

# +GF+

GF Piping Systems



# +GF+ SIGNET Signet 2551 Magmeter Flow Sensor

Available in a variety of wetted materials and ideal for pipe sizes up to DN300 (12 in.)



## Description

The Signet 2551 Magmeter is an insertion style magnetic flow sensor that features no moving parts. The patented\* sensor design is available in corrosion-resistant materials to provide long-term reliability with minimal maintenance costs. Material options include PP with stainless steel, PVDF with stainless steel, PVDF with Hastelloy-C, or PVDF with Titanium. Utilizing the comprehensive line of Signet installation fittings, sensor alignment and insertion depth is automatic. These versatile, simple-to-install sensors deliver accurate flow measurement over a wide dynamic range in pipe sizes ranging from DN15 to DN300 (0.5 to 12 inches), satisfying the requirements of many diverse applications.

Signet 2551 Magmeters offer many output options of frequency/digital (S<sup>3</sup>L), 4 to 20 mA or relays which are available on both the blind and display versions. The frequency or digital (S<sup>3</sup>L) sensor output can

be used with Signet's extensive line of flow instruments while the 4 to 20mA output can be used for a direct input to PLCs, chart recorders, etc. Both the 4 to 20 mA output and digital (S<sup>3</sup>L) sensor interface is available for long distance signal transmission of up to 1,000 ft. An additional benefit is the empty pipe detection which features a zero flow output when the sensors are not completely wetted. Also, the frequency output is bi-directional while the 4 to 20mA output can be set for uni- or bi-directional flow using the display or the RS232 set-up tool which connects to PCs for programming capabilities.

In addition the display version of the 2551 Magmeter is available with relays and features permanent and resettable total values which can be seen on the display. Also, the display contains multi-languages with English, Spanish, German, French, Italian and Portuguese menu options.

## Features









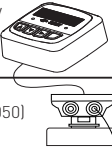
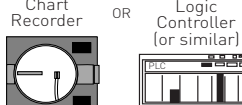

- Patented Magmeter technology
- No moving parts
- Bi-directional flow
- Empty pipe detection
- Installs into pipe sizes DN 15 to DN 300 (0.5 to 12 in.)
- Flow rate range 0.05 to 10 m/s (0.15 to 33 ft/s)
- Accurate measurement even in dirty liquids
- Blind 4 to 20 mA, digital/frequency, relay output
- No pressure drop
- Corrosion resistant materials; PP or PVDF with SS, Hastelloy C, or Titanium
- Multi-language display menu available

12

## Applications

- Chemical Processing
- Demineralization Regeneration
- Water and Waste Water Monitoring
- Metal Recovery and Landfill Leachate
- Commercial Pools, Spas, and Aquariums
- HVAC
- Irrigation
- Scrubber Control
- Neutralization Systems
- Industrial Water Distribution

## System Overview

<b>Stand-Alone</b>  <b>Signet 2551 Magmeter</b>  	<b>Panel Mount</b> Signet Flow Instrument (sold separately) 8900 8550 5075 5500 5600  	<b>Pipe, Tank, Wall Mount</b> Signet 8550 Flow Instrument (sold separately)  Signet Universal Adapter Kit (3-8050) (sold separately)  	<b>4 to 20 mA Input</b>  Chart Recorder OR Programmable Logic Controller (or similar)  
			
Signet Fittings (sold separately)  			



\* U.S. Patent No: 7,055,396 B1



**NEW! Signet 2552 Metal Magmeter Flow Sensor**



**Features**

- Patented\* Magmeter technology
- Easy to remove and re-install during maintenance
- Hot-tap version for installation and service without system shutdown
- NPT or ISO threads
- Optional detachable waterproof cable
- Three output choices: frequency, digital (S<sup>3</sup>L), or 4 to 20 mA
- Bi-directional flow
- No moving sensor parts
- Adjustable insertion for large pipe sizes up to DN 1200 (48 in.)
- Empty pipe detection
- Flow rate range 0.05 to 10 m/s (0.15 to 33 ft/s)
- Measurement in dirty and high solids content liquids

**Description**

The Signet 2552 Magmeter Flow Sensor is a heavy duty, high performance sensor in an adjustable-insertion configuration that can be used with a ball valve for hot-tap installations. This insertion style flow sensor has no moving parts and is constructed of corrosion-resistant materials to provide long-term reliability with minimal maintenance costs.

The 2552 is versatile and simple-to-install, delivering reliable flow measurement over a wide dynamic range in pipe sizes ranging from DN40 to DN1200 (1.5 to 48 inches). Signet 2552 Magmeters offer a variety of output options compatible with Signet

flow instrumentation that feature a frequency or digital (S<sup>3</sup>L) output. The blind transmitter (4 to 20 mA output) or digital sensor interface is available for long distance signal transmission.

The empty pipe detection features a zero flow output when the electrodes are not completely wetted. The frequency output is bi-directional while the 4 to 20 mA output can be set for uni- or bi-directional flow. The 4 to 20mA output is factory spanned and can be changed using the PC compatible accessory set-up tool.

**System Overview**

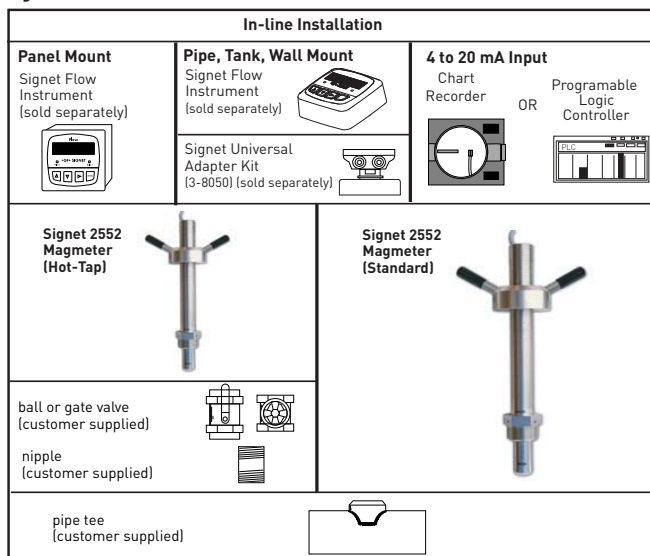

**Applications**

- Municipal Water Distribution
- Water Inlets to Process Plants
- Surface, Ground, and Ocean Water
- Chemical Processing
- Water and Wastewater Monitoring
- Industrial Water Distribution



\*U.S. Patent No.: 7,055,396 B1



## Signet 2750 and 2760 DryLoc® pH/ORP Sensor Electronics and Preamplifiers

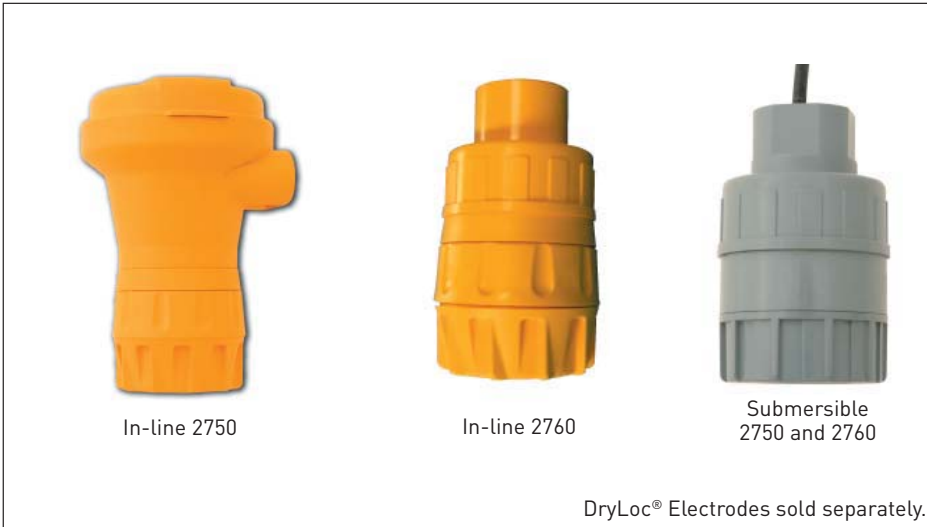

### Features

- In-line integral mount and submersible installation versions
- Automatic temperature compensation
- Auto configuration for pH or ORP operation
- Optional EasyCal calibration aid with automatic buffer recognition
- Junction boxes for convenient wiring
- Compatible with 3719 pH/ORP Wet-Tap

### Description

The Signet 2750 and 2760 pH/ORP Sensor Electronics and Preamplifiers, featuring DryLoc® connectors, provide a variety of functions to suit various requirements.

The 2760 is a preamplifier that allows any DryLoc® pH/ORP electrode to work with most Signet instruments. It is also sold as a simple connector for use with other manufacturers' instruments that do not require a preamplified signal.

The 2750 comes with the same pre-amplified signal as the 2760, but features two different outputs: a two-wire 4 to 20 mA loop output, or a digital (S<sup>3</sup>L) output which allows for longer cable lengths and is compatible with the Signet 8900 Multi-

Parameter Controller. The 2750 devices self-configure for pH or ORP operation via automatic recognition of the electrode type. The optional EasyCal feature allows simple push-button calibration and includes an LED indicator for visual feedback.

The DryLoc® electrode connector found on both models quickly forms a robust assembly for submersible and in-line installations. NEMA 4X junction enclosures are integral parts of the 2750 in-line version and are also available as accessories for both Models 2750 (submersible version) and 2760.



### Application

- Water/Wastewater Treatment
- Neutralization Systems
- Scrubber Control
- Effluent Monitoring
- Surface Finishing
- Flocculent Coagulation
- Heavy Metal Removal and Recovery
- Toxics Destruction
- Sanitization Systems
- Pool & Spa Control
- Aquatic Animal Life Support Systems

### System Overview

In-Line Installation			Submersible Installation	Wet-Tap Installation
<b>Panel Mount</b> Signet Instrument (sold separately) 5700 8750 8900 	<b>Pipe, Tank, Wall Mount</b> Signet pH/ORP Transmitter (sold separately) 8750 Signet Universal Adapter Kit (3-8050) (sold separately) 	<b>4 to 20 mA Input</b> Chart Recorder OR Programmable Logic Controller 	<b>Panel, Pipe, Tank, Wall Mount</b> Signet Instrument (sold separately) 5700 8750 8900 	
<b>Signet 2750 and 2760 Sensor Electronics and Preamplifier</b> 	<b>Signet 2760 Preamplifier</b> 	<b>Signet 2750 Sensor Electronics</b> 	Pipe extension or conduit with 3/4 in. NPT or ISO 7/1-R 3/4 threads (customer supplied) 	<b>Signet 2750 or 2760</b> 
DryLoc® pH/ORP Electrodes 2764-2767, 2754-2757, 2774-2777 (sold separately) 			<b>Signet 2750 and 2760 Sensor Electronics and Preamplifier</b> 	<b>Signet 3719 Wet-Tap with 2756 and 2757 Wet-Tap electrodes (sold separately)</b> 
2754-2757 DryLoc® Electrodes: Use Signet Fittings 2764-2767 and 2774-2777 DryLoc® Electrodes: Use 3/4 in. or 1 in. NPT fittings (customer supplied)			DryLoc® pH/ORP Electrodes 2764-2767, 2754-2757, 2774-2777 (sold separately) 	Signet Fittings* (sold separately)



## Signet 2754-2757 pH and ORP Electrodes



### Features

- Durable DryLoc® connector with gold plated contacts
- Self-cleaning flat versions reduce risk of glass breakage
- Large reference volume and solid polymer electrolyte
- Temperature sensor included in pH electrodes
- Wet-Tap electrodes available with glass or plastic bodies
- Wet-Tap electrodes can be mounted at any angle

### Description

The Signet 2754-2757 pH and ORP Electrodes feature a unique foul-proof DryLoc® connector with gold-plated contacts designed specifically for use with the Signet 2750 and 2760 Sensor Electronics and preamplifiers. These dependable and highly responsive electrodes feature a large reference chamber volume and intelligent positioning of internal elements that combine to extend the service life. The electrodes are offered with either flat or bulb sensing elements. The flat versions allow sediment and particles to sweep past the measurement surface, minimizing the risks of abrasion, break-

age and coating. The bulb versions can be used for general purpose applications and are also offered with a glass or plastic body for use with the 3719 Wet-Tap assembly.







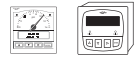

The choice of a PT-1000 or 3KΩ temperature sensor allows compatibility with all Signet pH/ORP instruments.

The 2754-2757 electrodes are the flagship sensors of the Signet pH/ORP product line. They are all-purpose sensors ideal for a wide range of universal applications.

### Applications

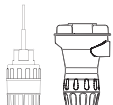
- Water & Wastewater Treatment
- Neutralization Systems
- Effluent Monitoring
- Sanitization Systems
- Pool & Spa Control
- Aquatic Animal Life Support Systems
- Process Control
- Cooling Towers
- Boiler Protection

### System Overview

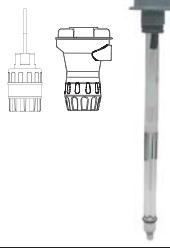
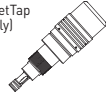
In-Line Installation		Submersible Installation	Wet-Tap Installation
<b>Panel Mount</b> Signet Instrument (sold separately) 5700 8750 8900 	<b>4 to 20 mA Input</b> Chart Recorder OR Programmable Logic Controller 	<b>Panel, Pipe, Tank, Wall Mount</b>  Signet Instrument (sold separately) 5700 8750 8900	
Signet 2750 and 2760 (sold separately) with  <b>Signet 2754-2757 DryLoc® pH/ORP Electrodes</b>	Signet 2750 Sensor Electronics (sold separately) with  <b>Signet 2754-2757 DryLoc® pH/ORP Electrodes</b>	Pipe extension or conduit with 3/4 in. NPT or ISO 7/1-R 3/4 threads (customer supplied) 	
Signet Fittings (sold separately) 	Signet 2750 and Signet 2760 (sold separately) with <b>Signet 2754-2757 DryLoc® pH/ORP Electrodes</b> 	<b>Signet 2756-WT or 2757-WT and 2750 or 2760 (sold separately)</b>  Signet 3719 WetTap (sold separately)  Signet Fittings (sold separately)	





## Signet 2764-2767 Differential DryLoc<sup>®</sup> pH/ORP Electrodes



### Description

The Signet 2764-2767 Differential pH & ORP electrodes are built with the DryLoc<sup>®</sup> connector, a Ryton<sup>®</sup> body, and PTFE reference junction to handle even the most extreme and harshest of chemical applications.

These differential electrodes use the field-proven 3-electrode differential technique: the pH and reference electrodes are measured against a ground electrode, insuring a steady and stable signal. The key feature of the differential design is the reference electrode. The reference element is housed in a glass half-cell embedded in the reference chamber and is protected from compounds that may contain sulfides (H<sub>2</sub>S) and metals, including lead, mercury, and silver. To ensure a long service life, the reference features a refillable electrolyte chamber and a replaceable equitransferant salt bridge, both easily serviced in the field. The patented porous PTFE reference junction resists fouling, clogging and chemical attack.

The other elements of the design are the solution ground, the pH/ORP electrodes, and the temperature element. The solution ground eliminates noisy measurements by draining electrical current away from the reference electrode. The pH/ORP electrodes are designed with a flat or bulb measurement surface, and a temperature device that is positioned at the tip of the measurement surface, making the temperature response of T<sub>95%</sub> less than 1 minute. Various temperature devices offered include 3K $\Omega$ , 300 $\Omega$ , or PT-1000 RTD. The electrodes are used with the Signet 2750 Sensor Electronics, which provides a blind 4 to 20 mA output or using the digital (S<sup>3</sup>L) output may be used to connect to the Signet 8900 instrument. The electrodes can also be used with the Model 2760 preamplifier to connect to the Signet 5700, 8750, or other suppliers' instruments.

### System Overview

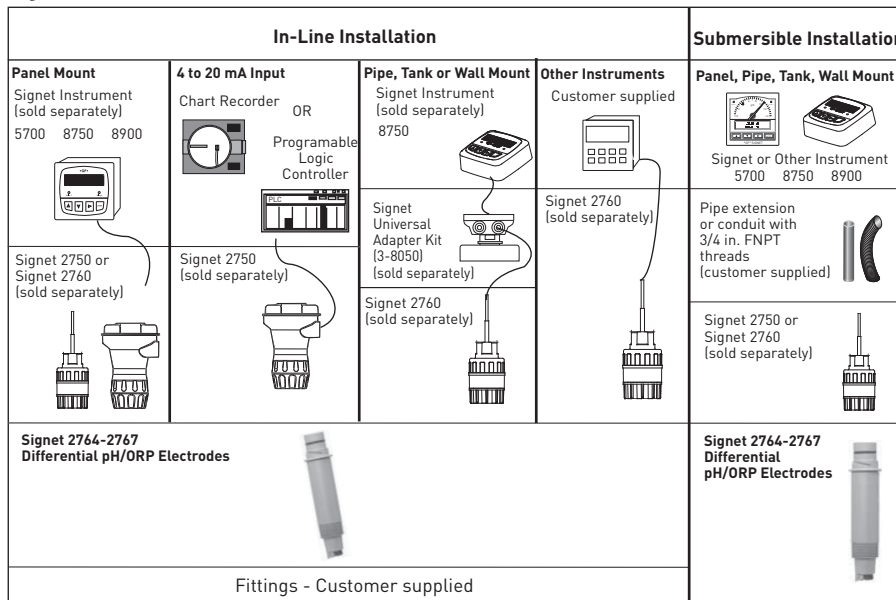

### Features

- Differential design for stable measurements in the most aggressive applications
- Long service life even in severe or difficult chemical applications
- Water-tight DryLoc<sup>®</sup> connector with foul-proof gold contacts
- Porous PTFE reference junction
- Rebuildable reference electrode
- Solution ground
- Temperature sensor (pH)
- Easy sensor replacement using DryLoc<sup>®</sup> electrode connector
- Quick temperature response
- Compatible with all Signet instruments and other suppliers' pH/ORP instruments

### Applications

- Water and Waste Water Treatment
- Coagulation and Flocculation
- Plant Effluent
- Plating Baths
- Scrubbers
- Textile Dye Process
- Harsh Chemical Applications
- Heavy metal Removal and Recovery
- Toxics Destruction
- Surface Finishing



## Signet 2774-2777 Threaded DryLoc® pH/ORP Electrode



### Features

- Durable DryLoc® connector with gold plated contacts
- Special design allows for installation at any angle, even inverted
- Quick temperature response
- Easy sensor replacement using DryLoc® electrode connector
- High temperature versions available
- Mounts into standard 3/4 inch threads
- Compatible with all Signet pH/ORP instruments

### Description

The Signet 2774 - 2777 pH and ORP Electrodes feature a unique foul-proof DryLoc® connector with gold-plated contacts designed specifically for use with the Signet 2750 and 2760 preamplifiers, sensor electronics, and connectors. These dependable and highly responsive electrodes feature a PTFE double reference junction and a large reference chamber that combine to extend the service-life. Embedded positioning of the temperature element in the pH/ORP sensing tip allows the temperature

response to be quick and accurate. The electrodes are offered with either flat or bulb style sensing elements. The flat versions allow sediment and particles to sweep past the measurement surface, minimizing risks of abrasion, breakage and coating. The bulb versions can be used for general-purpose applications. Due to the specially designed chambers which keep electrolyte in place, all versions can be installed at any angle, even inverted.

### Applications

- Water Treatment & Water Quality Monitoring
- Demineralizer, Regeneration & Rinse
- Cooling Tower and Boiler Protection
- Aquatic Animal Life Support Systems
- Pool and Spa Control
- Neutralization Systems

### System Overview

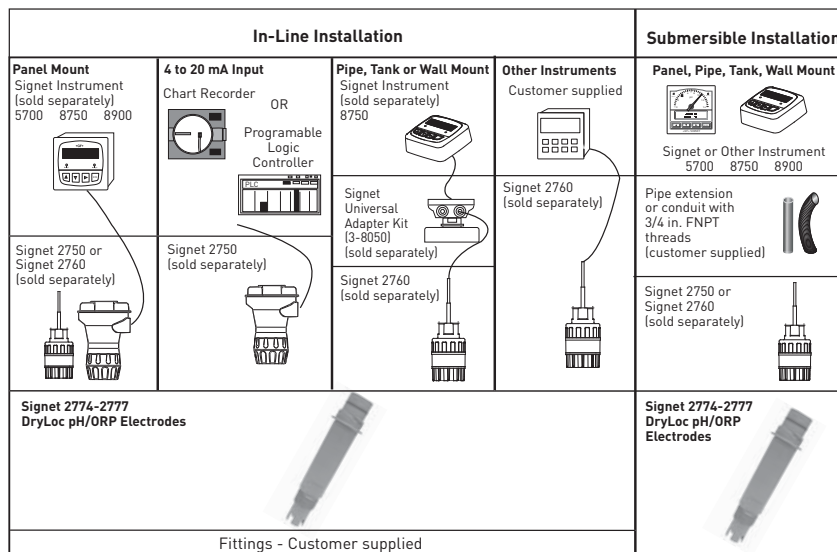

## Signet 2819-2823 Conductivity/Resistivity Electrodes

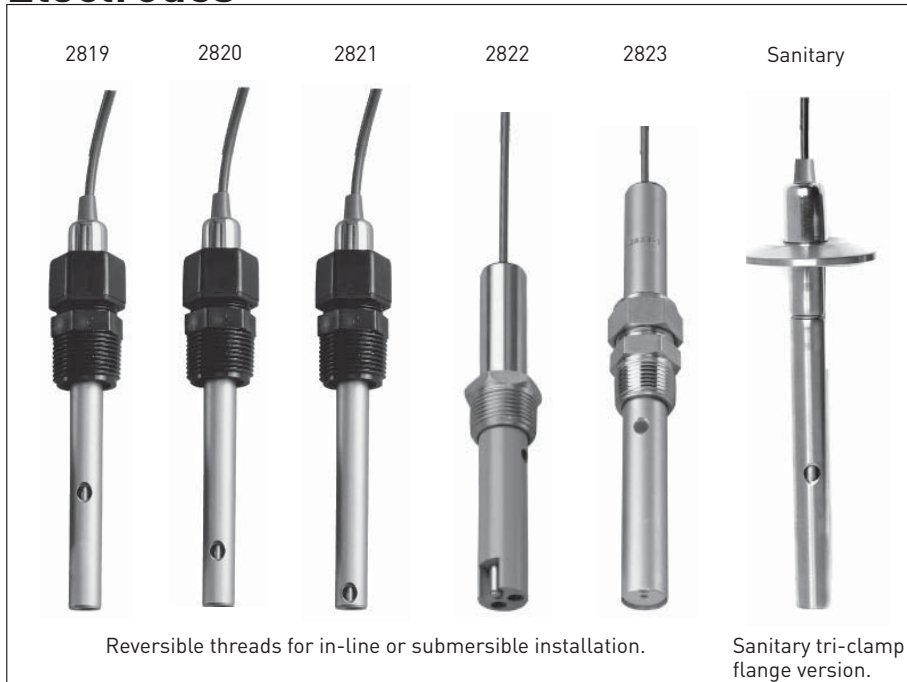

Reversible threads for in-line or submersible installation. Sanitary tri-clamp flange version.

### Features

- Standard process connections
  - 3/4" NPT Polypro
  - Tri-clamp 1 - 1 1/2", 2"
  - Opt. 1/2" NPT 316 SS
- 316 SS or Titanium standard electrode
- Alternative electrode materials available
  - Hastelloy-C
  - Monel
- In-line or submersible mounting
- NIST traceable certified cells ±1% meet USP requirements

### Application

- Pure Water Treatment
  - Reverse Osmosis
  - Deionization
  - Distillation
- Boiler Condensate
- Semiconductor Water Production
- Rinse Water Monitoring and Control
- Chemical Concentrations
- Cleaner and Degreaser Concentrations
- TDS (Total Dissolved Solids)
- Salinity
- USP Purified Water
- WFI Water Production
- Ultra Pure Water

### Description

Signet 2819-2823 Conductivity/Resistivity Electrodes are designed to provide versatile installation and accurate sensing across a very broad dynamic range. These electrodes are built with a controlled surface finish to ensure accuracy and repeatability. The standard electrode is constructed 316SS or Titanium, but there are other materials available for maximum chemical compatibility. Reversible threads or sanitary flanges allow for maximum

installation versatility. Sanitary flange versions are available with an optional NIST Traceability Certificate to meet USP requirements. Coupled with Signet patented measuring circuitry, a three decade measurement range is achieved without the need for troublesome electrode platinization. A platinum RTD (PT-1000) located within the electrode allows optimal temperature sensing.



### System Overview

In-Line Installation				Submersible Installation*			
<b>Panel Mount</b> Signet Conductivity Instrument (sold separately) 8850 8860 5800CR 	<b>Pipe, Tank, Wall Mount</b> Signet Conductivity Instrument (sold separately) 8850 8860 5800CR 	<b>Integral Mount</b> Signet Conductivity Instrument (sold separately) 8850 	<b>Panel Mount</b> Signet 8900 Instrument (sold separately) 	<b>4 to 20 mA Input</b> Programmable Logic Controller 	<b>Panel Mount</b> Signet 8900 Instrument (sold separately) 	<b>4 to 20 mA Input</b> Programmable Logic Controller 	<b>Panel, Pipe, Tank, Wall Mount</b> Signet Cond. Instrument 8850 8860 8900 5800CR 
<b>Signet 2819-2823 Conductivity Electrodes</b> 	<b>Signet 2819-2823 Conductivity Electrodes</b> 	<b>Signet 2819-2823 Conductivity Electrodes</b> 	Signet 2850 Universal Mount 	Signet 2819-2823 Conductivity Electrodes 	Signet 2850 Universal Mount or Threaded J-Box 	Pipe extension or conduit with 3/4 in. FNPT threads (customer supplied) 	<b>Signet 2819-2823 Conductivity Electrodes</b> 

Fittings - Customer supplied

\*Submersible installation not applicable for Sanitary Conductivity Electrode.



**Signet 2839-2842 Conductivity Electrodes**



**Features**

- Dual-threaded
- Compact electrode length for easy in-line installation in small pipe sizes
- Triple orifice flow-through design reduces clogging and bubble entrapment
- 316SS electrodes with injection molded PEEK™ process connections and insulators
- Cell constants may be traceable to NIST and certified to within ±1% of value - meets USP requirements

**Description**

The Signet 2839-2842 Conductivity/Resistivity Electrodes are available in four cell constants from 0.01 to 10.0 cm<sup>-1</sup>, and are suitable for a wide variety of applications from high purity water quality monitoring to weak acids and bases. 316SS electrode surface finishes are controlled in a precision bead blasting operation to ensure measurement accuracy and

repeatability. The PEEK™ insulator and process connections are injection over-molded to minimize variance between electrodes. Double threaded connections in either 3/4 in. NPT or ISO 7/1-R 3/4 enable quick and easy installation in submersible or in-line configurations. Transmitter integral mounting kit and junction boxes are available as accessories.



**Applications**

- Water Treatment & Water Quality Monitoring
- Reverse Osmosis
- Deionization
- Cooling tower and Boiler Protection
- Distillation
- Desalination
- Demineralizer
- Semiconductor
- Aquatic Animal Life Support Systems

**System Overview**

In-Line Installation					Submersible Installation
<b>Panel Mount</b> Signet Conductivity Instrument (sold separately) 8850 8860 5800CR 	<b>Pipe, Tank, Wall Mount</b> Signet 8850 Conductivity Instrument (sold separately)  Signet Universal Adapter Kit (3-8050) (sold separately) 	<b>Integral Mount</b> Signet 8850 Conductivity Instrument (sold separately)  Signet Integral Adapter Kit (3-8052) (sold separately) 	<b>Multi-Parameter Panel Mount</b> Signet 8900 Instrument (sold separately)  Signet 2850 In-Line Conductivity Sensor (sold separately) 	<b>4 to 20mA Input</b> Chart Recorder (sold separately) OR Programmable Logic Controller  Signet 2850 In-Line Conductivity Sensor (sold separately) 	<b>Panel, Pipe, Tank, Wall Mount</b> Signet Conductivity Instrument 8850 8860 8900 5800CR  Pipe extension or conduit with 3/4 in. FNPT threads (customer supplied) AND/OR Signet 2850 Submersible Conductivity Sensor 
Signet 2839-2842 Conductivity Electrodes 	Signet 2839-2842 Conductivity Electrodes 	Signet 2839-2842 Conductivity Electrodes 	Signet 2839-2842 Conductivity Electrodes 	Signet 2839-2842 Conductivity Electrodes 	Signet 2839-2842 Conductivity Electrodes 
Fittings - Customer supplied, 3/4 in. NPT or ISO threaded					



# +GF+ SIGNET \_\_\_\_\_ Conductivity/Resistivity Sensor Electronics and Integral Systems

## Signet 2850 Conductivity/Resistivity Sensor Electronics and Integral Systems



### Description

The Signet 2850 Conductivity/Resistivity Sensor Electronics are available in various configurations for maximum installation flexibility. The universal mount version is for pipe, wall, or tank mounting and enables single or dual (digital versions only) inputs using any standard Signet conductivity / resistivity sensor. The threaded j-box version can be used with these same Signet sensors for submersible sensor mounting. It is also available as a combined integral system configuration for in-line mounting and includes a conductivity electrode in a choice of 0.01, 0.1, 1.0, or 10.0  $\text{cm}^{-1}$  cell constants. The 2850 is ideal for applications with a conductivity range of 0.055 to 200,000  $\mu\text{S}$  or a resistivity range of 18.2 M $\Omega$  to 10 k $\Omega$ .

All 2850 units are available with a choice of two outputs, digital (S<sup>3</sup>L) or 4 to 20 mA. The digital

(S<sup>3</sup>L) output version allows for up to six sensor inputs directly into the Signet 8900 Multi-Parameter Controller. The two-wire 4 to 20 mA output is available with eight 4 to 20 mA output ranges for each electrode cell constant. Additionally, each range can be inverted and are field selectable by the user.

All 2850 units are built with NEMA 4X/IP 65 enclosures which allow wiring connections with long cable runs of up to 1,000 feet (305 m). EasyCal is a standard feature that automatically recognizes conductivity test solution values for simple field calibration. A calibration tool is available for validation of the sensor electronics according to USP requirements.

### Features

- Integral mount systems for quick and easy installation
- Compact design for maximum installation flexibility
- Digital (S<sup>3</sup>L) interface or two-wire 4 to 20 mA output
- EasyCal with automatic test solution recognition
- Dual channel unit available for low cost installation with Signet 8900 Multi-Parameter Controller
- For use with ALL Signet conductivity electrodes

### Applications

- Water Treatment & Water Quality Monitoring
- Reverse Osmosis
- Deionization
- Demineralizer, Regeneration & Rinse
- Scrubber, Cooling tower and Boiler Protection
- Aquatic Animal Life Support Systems

12

### System Overview

In-Line Sensor Installation				Submersible Installation	
<b>Panel Mount</b> Signet 8900 Instrument (sold separately)	<b>4 to 20 mA Input</b> Programmable Logic Controller	<b>Panel Mount</b> Signet 8900 Instrument (sold separately)	<b>4 to 20 mA Input</b> Programmable Logic Controller	<b>Panel Mount</b> Signet 8900 Instrument (sold separately)	<b>4 to 20 mA Input</b> Programmable Logic Controller
<b>Signet 2850 Conductivity System</b>		<b>Signet 2850 Universal Mount</b>		<b>Signet 2850 Universal Mount or Threaded J-Box</b>	
		Signet 2819-2823 or 2839-2842 Conductivity Electrode (sold separately)			
Fittings [3/4 in. NPT or ISO] - Customer supplied					





**Features**

- Allows sensor removal without process shutdown
- Pressure release valve for safe sensor removal
- Dual safety lanyards
- Rugged corrosion-resistant PVC construction and stainless steel hardware
- Compatible with Signet 515 or 2536 Rotor-X Wet-Tap Flow Sensors
- Eliminates Process Downtime

**Description**

The Signet 3519 Flow Wet-Tap Valve serves as a unique interface between the installation fitting and the wet-tap style Signet 515 or 2536 Rotor-X flow sensor. It provides a fast method of removing the sensor from the pipe under specified operating pressures. The PVC & stainless steel design of the Wet-Tap makes it resistant to corrosion and chemical attack by acids, alkalies, salt, and a number of other harsh chemicals.

The Signet 3519 Wet-Tap Valve mounts directly onto standard Signet installation fittings. The 3519 Wet-Tap consists of a flange and support plate that threads onto the pipe fitting insert, and a PVC ball valve through which an extended length sensor is inserted into the pipe.

**Applications**

- Filtration Systems
- Chemical Production
- Pump Protection
- Scrubbers
- Water Distribution
- Effluent Totalization
- Process Cooling Loops

**System Overview**

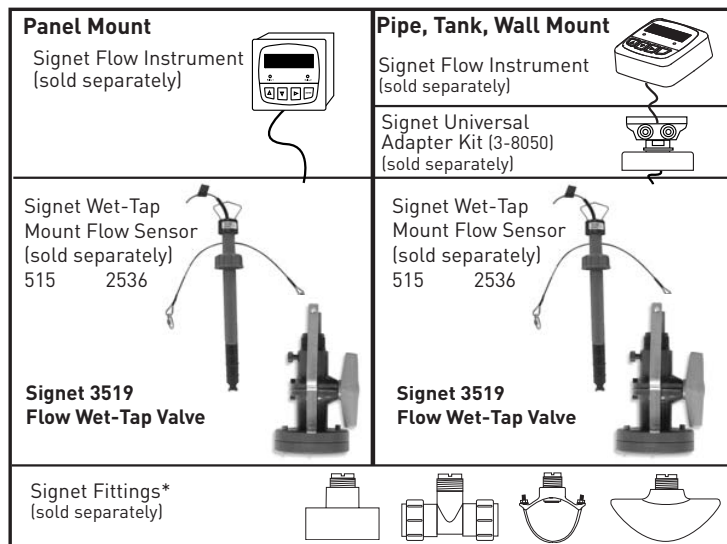

**Signet 3719 pH/ORP Wet-Tap Assembly**



**Features**

- Electrode removal without process shutdown
- Space saving 45mm (1.75 in.) short-stroke design
- Sealed pneumatic dampening for smooth and safe operation
- SafeLoc™: Cam-activated automatic locking mechanism
- Protects electrode sensing surface from breakage
- Suitable for mounting in any orientation
- Process threaded connection NPT or ISO
- Low profile clamp-on saddle fittings for convenient installation in ASTM pipe sizes 2.5 to 12 in.

**Description**

The Signet 3719 pH/ORP Wet-Tap allows installation and removal of pH or ORP electrodes, even under process pressure, without the need for process shutdown during routine electrode maintenance and calibration. Automatic process isolation is achieved during electrode retraction with a double O-ring seal on a

unique and compact retraction assembly; no separate valve is required. A patented cam-activated automatic locking mechanism, SafeLoc™, and the short stroke design help to assure operator safety. The wet-tap unit can be mounted at any angle and can be used with the Signet DryLoc® and Twist-Lock Wet-Tap electrodes.

**System Overview**

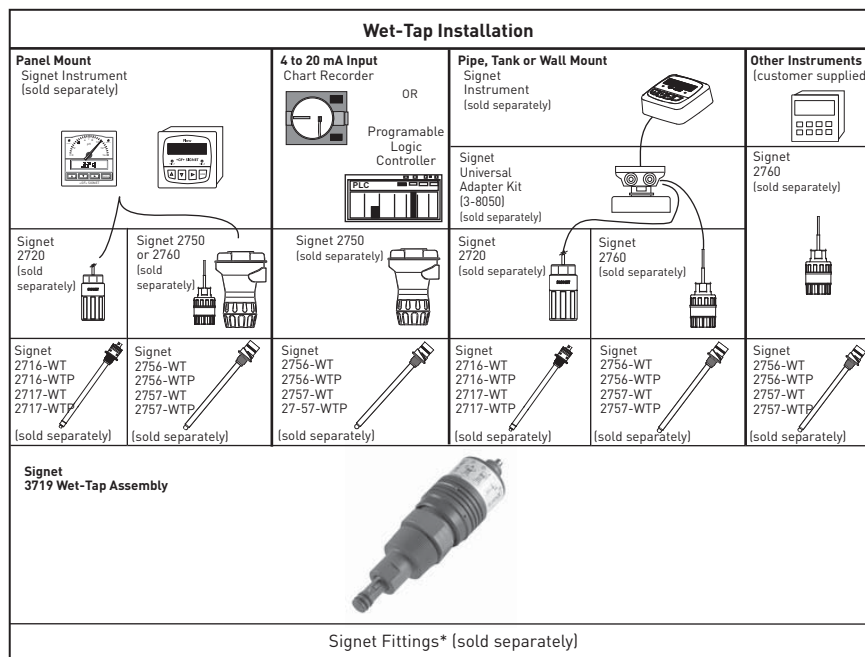

**Applications**

- Aquatic Animal Life Support Systems
- Recreational Water Monitoring
- Water & Wastewater Treatment
- Effluent Monitoring
- Neutralization Systems
- Sanitization Systems

## Signet 8550 Flow Transmitters



### Features

- 2 or 4 wire power
- Available with single or dual input/output
- 4 to 20 mA Scaleable outputs
- Permanent & resettable totalizers
- Relay options available
- NEMA 4X enclosure with self-healing window
- Output simulation for complete system testing

### Description

Signet 8550 Flow Transmitters are advanced instruments that convert the signal from all Signet flow sensors into a 4 to 20 mA signal for long distance transmission. Configuration flexibility is maximized with single or dual input/output, two optional relays for process control, two packaging

options for integral/pipe mount or panel installation, and scalability for virtually any flow range or engineering unit. State-of-the-art electronic design ensures long-term reliability, signal stability, and simple user setup and operation.

### Applications

- Flow control and monitoring
- Filtration or softener regeneration
- Effluent totalization
- Pump protection
- Feed pump pulsing
- Ratio control
- Water distribution
- Leak detection

### System Overview

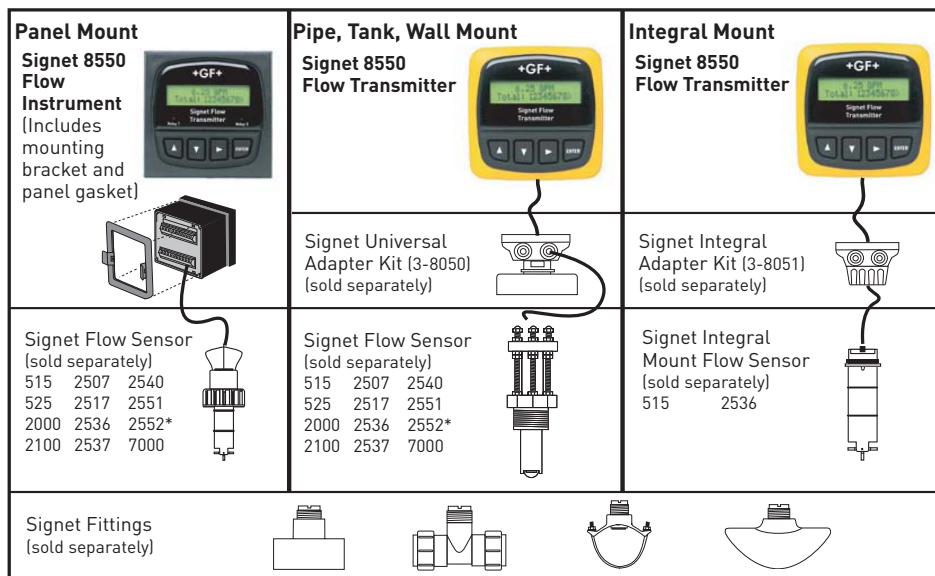



## Signet 8750 pH/ORP Transmitters



### Features

- Automatic temperature compensation
- Temperature display in °C or °F
- Hold and simulate functions
- Relay options available
- Output scalability
- Optional Dual output
- NEMA 4X/IP65 enclosure with self-healing window
- EasyCal option available

### Description

The Signet 8750 pH/ORP Transmitter is designed for broad application and ease of setup and use. The unit auto-configures for either pH or ORP use when connected to Signet pH or ORP electrodes. Multiple mounting options allow for installation best suited to your particular application.

The EasyCal menu features automatic buffer recognition for mistake-proof pH or ORP electrode calibrations. Intuitive software and the four button keypad arrangement make it easy to access important information such as pH or ORP, mV input, temperature, calibration, relay set-up menus and more.

### Applications

- Neutralization Systems
- Heavy Metals Recovery
- Plating Control
- Scrubber Control
- Pool and Spa Control
- Environmental Study
- Water Treatment
- Water Quality Monitoring
- Waste Treatment
- Disinfection

### System Overview

In-Line Sensor Installation		Submersible Sensor Installation																	
<p><b>Panel Mount</b> Signet 8750 pH/ORP Instrument</p>	<p><b>Pipe, Tank, Wall Mount</b> Signet 8750 pH/ORP Instrument</p>	<p><b>Panel, Pipe, Tank, Wall Mount</b></p> <p>Signet 8750 pH/ORP Instrument</p>																	
<p>Signet 2720 and 2760 Preamplifier (sold separately)</p>		<p>Signet Universal Adapter Kit (3-8050) (sold separately)</p>																	
<p>Signet pH/ORP electrode (sold separately)</p> <table style="font-size: 10px;"> <tr><td>2714</td><td>2754</td><td>2764</td><td>2774</td></tr> <tr><td>2715</td><td>2755</td><td>2765</td><td>2775</td></tr> <tr><td>2716</td><td>2756</td><td>2766</td><td>2776</td></tr> <tr><td>2717</td><td>2757</td><td>2767</td><td>2777</td></tr> </table>		2714	2754	2764	2774	2715	2755	2765	2775	2716	2756	2766	2776	2717	2757	2767	2777	<p>Pipe extension or conduit with 3/4 in. NPT or ISO 7/1-R 3/4 threads</p>	
2714	2754	2764	2774																
2715	2755	2765	2775																
2716	2756	2766	2776																
2717	2757	2767	2777																
<p>Signet Fittings (sold separately) or customer supplied fittings</p>		<p>Signet 2720 and 2760 Preamplifier (sold separately)</p>																	
		<p>Signet pH/ORP electrode (sold separately)</p> <table style="font-size: 10px;"> <tr><td>2714</td><td>2754</td><td>2764</td><td>2774</td></tr> <tr><td>2715</td><td>2755</td><td>2765</td><td>2775</td></tr> <tr><td>2716</td><td>2756</td><td>2766</td><td>2776</td></tr> <tr><td>2717</td><td>2757</td><td>2767</td><td>2777</td></tr> </table>		2714	2754	2764	2774	2715	2755	2765	2775	2716	2756	2766	2776	2717	2757	2767	2777
2714	2754	2764	2774																
2715	2755	2765	2775																
2716	2756	2766	2776																
2717	2757	2767	2777																



## Signet 8850 Conductivity Transmitters



### Description

The Signet 8850 Conductivity Transmitter is designed for multiple installation capabilities, simple set-up and easy operation, thus satisfying a broad range of application requirements.

Full microprocessor based electronics allow for a wide operating range and long term signal stability in three different instrument versions: the 8850-1 for a traditional two-wire current loop, the 8850-2 features current loop plus two dry contact

relays, or the 8850-3 with two-wire current loop, one sensor input signal and two current loop outputs. The 8850 is offered with a NEMA 4X/IP65 front panel with a self-healing window in a convenient 1/4 DIN package for easy mounting. The 8850 can be configured via a simple menu system.

In addition to programmable outputs and relays, the unit can also be set up to measure raw conductivity values, hence meeting USP requirements.

### Features

- Meets USP requirements for raw conductivity measurements
- Display choices of  $\mu\text{S}$ , mS, K $\Omega$ , M $\Omega$ , PPM (TDS)
- Simulate function
- Programmable temperature compensation
- Relay and open collector options
- Dual output option allows temperature and process signal transmission
- NEMA 4X/IP65 enclosure with self-healing window
- Compatible with ALL Signet conductivity electrodes

### Application

- RO/DI System Control
- Rinse Tank Control
- Cooling Tower, Scrubber or Blowdown Control
- Environmental Study (TDS)
- Desalination Monitor
- Water Quality Monitoring
- Leak Detection
- Chemical Concentration

### System Overview

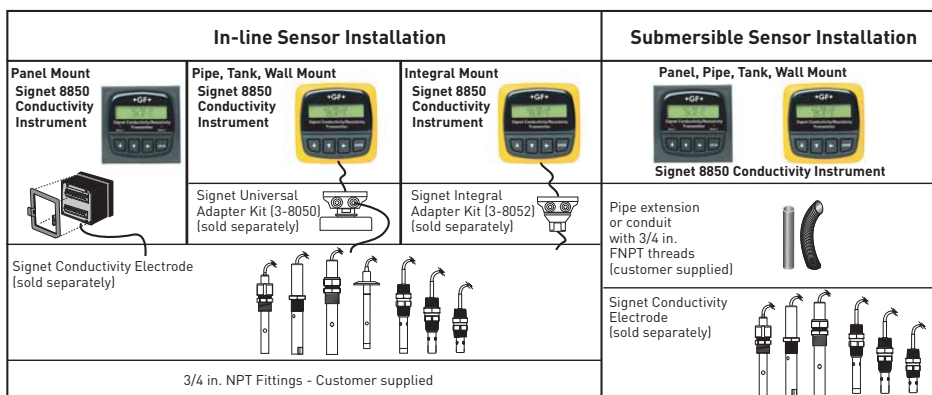

Note: Submersible installation not applicable for Sanitary Conductivity Electrode.



## Signet 8860 Two-Channel Conductivity Controller

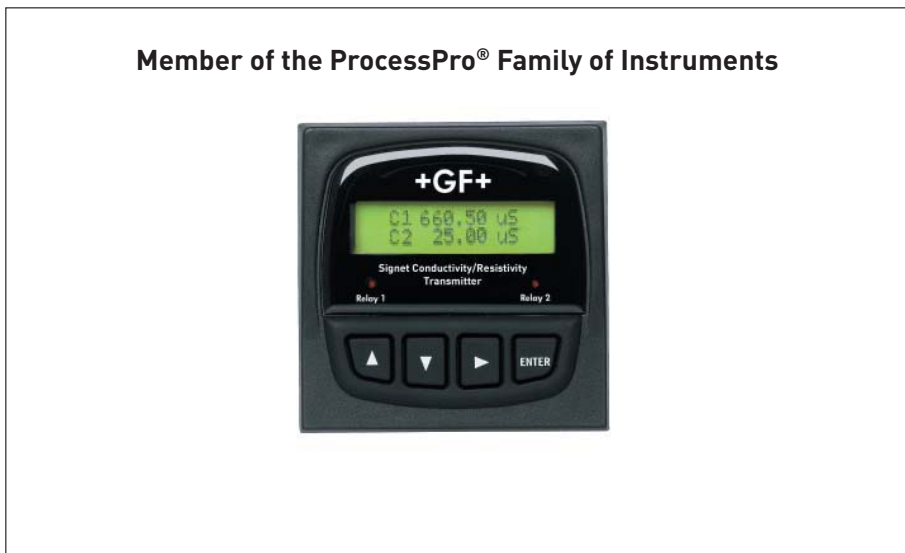

### Features

- Meets USP requirements for measuring raw conductivity, USP alarm mode
- Dual sensor input
- AC or DC powered
- Display and/or control:  $\mu$ S, mS, PPM or PPB (TDS), k $\Omega$ , M $\Omega$ , % rejection, difference, ratio, °C or °F
- Three fully scaleable 4 to 20 mA outputs
- Two open collector outputs
- Four programmable relays
- Time delay relay function
- Proportional pulse control capability
- Compatible with ALL Signet conductivity electrodes
- Programmable temperature compensation
- NEMA 4X/IP65

### Description

The Signet 8860 Two-Channel Conductivity Controller is packed with a set of features and capabilities ideal for the real needs of water treatment applications. It accommodates two separate and independent input sources and can be powered with AC or 24VDC. The 8860 programs via a simple and intuitive menu system. The unit can also be programmed to measure a raw conductivity value by turning off the temperature compensation mode, hence meeting USP requirements.

To control the process, the 8860 is equipped with four dry contact relays and three 4 to 20mA output loops. Calculated measurement include Difference, Ratio or % Rejection. Two of the relays may be converted into open collector outputs with the flip of a switch. Operating modes for the relays and open collector outputs are high, or low alarm, pulse, or special USP alarm mode. The 8860 is offered with a NEMA 4X/IP65 front panel with a self-healing window in a 1/4 DIN package for easy panel installation.

12

### System Overview

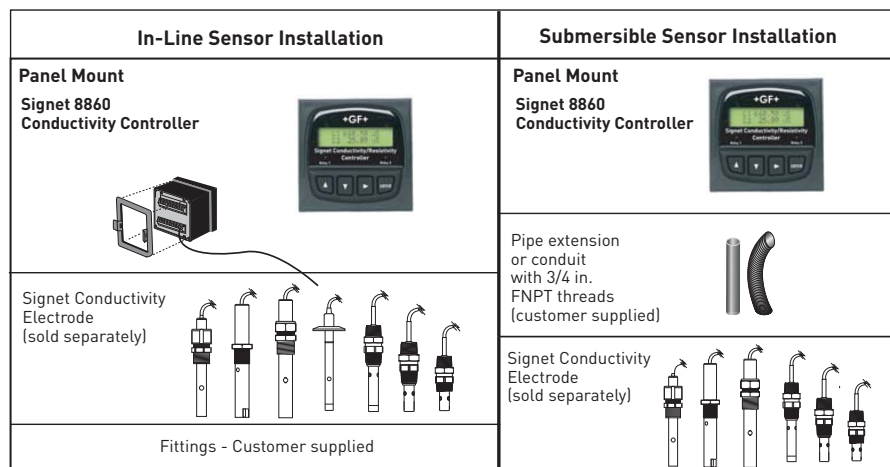

Note: Submersible installation not applicable for Sanitary Conductivity Electrode.

### Application

- RO/DI System Control
- Demineralizer Regeneration and Rinse
- Scrubber, Cooling Tower & Boiler Protection
- Chemical Concentration
- Rinse Tank Water Quality
- Desalination
- Leak Detection
- Aquatic Animal Life Support Systems
- Aquaculture
- Environmental Studies





# Point Level Monitors

## POINT LEVEL MONITORS



**KA, KAX**

**SafePoint®**



### ROTARY PADDLE

- ▶ Industry Leading Motor Shut-Off Feature
- ▶ Economical, Versatile Point Level Bin Monitor
- ▶ Simple Electro-Mechanical Operation
- ▶ Rugged, Cast Aluminum Construction
- ▶ Dependable Design Reduces Component Wear
- ▶ UL, CSA, CENELEC, SAA Approved
- ▶ Industry-First Magnetic Sensing (Patent Pending)
- ▶ Unique Housing Design
- ▶ Featuring a Twist On/Off Cover
- ▶ "True" Fail-Safe Design
- ▶ Microcontroller-Based Reliability
- ▶ Material Sense and Fault Outputs
- ▶ CSA<sub>usc</sub> Approvals
- ▶ Local Status Indicating Light on Most Models

**TrueCap® MK-2/MK-2e**



### RF Capacitance

- ▶ Superior 0.5pF Sensitivity
- ▶ Advanced Microcontroller (MK-2)
- ▶ Built-Up Immunity
- ▶ Automatic Temperature Compensation (MK-2)
- ▶ Push-Button Calibration (MK-2)
- ▶ Remote Calibration (MK-2)
- ▶ Multiple Electronics Versions
- ▶ Multiple Probe Variations
- ▶ Screw-On Cover
- ▶ Explosion-Proof Models Available

- ▶ Compatible with Most Granular, Pelletized and Powder/Bulk Applications
- ▶ For Products Ranging from 5 lb/ft<sup>3</sup> to Over 100 lb/ft<sup>3</sup>
- ▶ Applications Where Low-Cost, Low-Tech Controls Are Preferred
- ▶ Ideal on Vessels with Changing Contents
- ▶ Feed/Grain, Plastics, Wood, Sand/Gravel, Concrete/Aggregate, Mining, Pre-Mix Ingredients and Many More
- ▶ Compatible with Most Granular, Pelletized and Powder/Bulk Applications
- ▶ For Products Ranging from 5 lb/ft<sup>3</sup> to Over 100 lb/ft<sup>3</sup>
- ▶ Critical Applications Where Fail-Safe Operation is Required
- ▶ Ideal on Vessels with Changing Contents
- ▶ Feed/Grain, Plastics, Wood, Sand/Gravel, Concrete/Aggregate, Mining, Pre-Mix Ingredients and Many More



**VibraRod™/VibraFork™**

### VIBRATORY

- ▶ Superior Single-Probe Design for Solids (**VibraRod**)
- ▶ Local Status Indicating Light
- ▶ Screw-On Cover
- ▶ High Frequency Ignores External Vibration (**VibraFork**)
- ▶ Plastic or Metallic Housing
- ▶ Variety of Outputs/Probe Lengths
- ▶ Cable-Probe (**VibraRod**)
- ▶ Intrinsically Safe and Dust Ignition-Proof Versions

- ▶ Lightweight Solids Down to 3.1 lb/ft<sup>3</sup> (**VibraRod**)
- ▶ Liquids Minimum SG of 0.7 (**VibraFork**)
- ▶ Low or High Level
- ▶ Ideal in Applications Where Composition Changes Occur
- ▶ Plastics, Packing Materials, Cement, Cereal, Chemicals and Many Liquids (**VibraFork** only)



**G, GX, GX-SS**

### DIAPHRAGM TYPE

- ▶ Economical, Reliable, Durable Operation
- ▶ Multiple Diaphragm Materials Available
- ▶ Adjustable Sensitivity
- ▶ Low-Profile Mounting Minimizes Protrusion into Vessel
- ▶ Over-Pressure Protection
- ▶ Dust-Ignition Proof Models Available

- ▶ Free-Flowing Solids
- ▶ 15 - 60 lb/ft<sup>3</sup> Density
- ▶ Ideal for Budget Constrained Applications
- ▶ Ideal for Feed Industry
- ▶ Some Plugged Chute Applications
- ▶ Abrasive Materials (Hycar Cover)
- ▶ Feed/Grain, Light Powders and Granules, Plastics, Rubber and Many Other Applications

### PRODUCT OPERATING PRINCIPLE

F E A T U R E S

A P P L I C A T I O N S



## BIN AERATION DEVICES



**AIR PAD/VEASSER/FLO-PAD**

**BIN AERATION**

- ▶ Eliminate Bridging, Ratholing, Arching, and Clinging
- ▶ Loosen, Separate, and Aerate Solid Materials
- ▶ Keep Materials Moving During Discharge
- ▶ Operate without Vibration
- ▶ Simple Designs Facilitate Trouble-Free Operation
- ▶ Multiple Configurations Available

## EMISSION MONITOR



**DustAlarm®**

**TRIBOELECTRIC**

- ▶ Proven Triboelectric Technology
- ▶ Economical
- ▶ Relay Output
- ▶ Multiple Probe Lengths
- ▶ Rugged Construction
- ▶ Adjustable Sensitivity
- ▶ Easy Setup
- ▶ Stainless Steel Probe
- ▶ Quick-Disconnect Assemblies Available

## SOLIDS FLOW MONITORS



**SFD-2 & SFI**

**MICROWAVE**

- ▶ Non-Intrusive, Non-Contact Devices
- ▶ Adjustable Sensitivity
- ▶ Excellent Sensitivity
- ▶ Unaffected by Humidity, Ambient Light, Pressure, Temperature Variations, or Dust
- ▶ Relay (SFD-2) or Analog (SFI) Output
- ▶ Maintenance Free - No Moving Parts

## CONTINUOUS LEVEL MONITORS



**SiloPatrol®**

**CABLE-BASED SMART SENSOR**

- ▶ Robust Design
- ▶ Smart Sensor Technology
- ▶ Virtually Maintenance-Free
- ▶ Easy to Setup and Install
- ▶ Multi-Functional HMI
- ▶ PC-Based Server/Client Inventory Management
- ▶ ActiveX® Controls
- ▶ Output and Remote Display Accessories
- ▶ Wireless Sensor Communications Interface

**BulkSonic®**

**ULTRASONIC**

- ▶ Industry Leading Narrow Beam Angle
- ▶ Reliable, Repeatable, Non-Contact Field-Proven Technology for Bulk Solid and Liquid Applications
- ▶ Excellent Performance in Dusty Applications
- ▶ Transmitters or Sensor/Controller Systems
- ▶ Software for Optimization in Difficult Solids Applications

- ▶ For Use with Compacting Materials Requiring Fluidization or Dislodging
- ▶ Materials up to 100 lb/ft<sup>3</sup>
- ▶ Solve Arching, Bridging, Ratholing or Product Hang-Up Problems Commonly Associated with the Cone Section
- ▶ Cement, Sand, Woodchips, PVC Powder, Plastic Shavings, Lime, Flakes and Many Other Difficult to Handle Materials

- ▶ Continuous Emission Monitoring of Dust Collectors
- ▶ Specifically Designed to Monitor Dust Concentrations Ideal for Use in Ducts of Baghouses, Cartridge Collectors and Cyclones
- ▶ Continuous Monitoring for Detecting Filter Failures
- ▶ Ferrous/Non-Ferrous Metals, Chemicals, Foundries, Fly Ash, Plastics, Utilities, Mining, Pulp/Paper, and Many More Applications

- ▶ Senses Flow/No-Flow Conditions in Gravity Chutes and Pneumatic Lines
- ▶ Detects Flow Stoppage Caused by Bridging, Plugging or Equipment Failure
- ▶ Verifies Flow for Bagging or Batching Operations
- ▶ Dusty Applications
- ▶ Feed, Plastic, Pet Food, Ores, Sawdust, Fly Ash, Coal, Limestone and Many More Applications

- ▶ Compatible with Many Dry and Liquid Materials in Tanks and Silos
- ▶ Displays English/Metric Units
- ▶ Vendor Managed Inventory
- ▶ Multi-User Access Available
- ▶ Multiple Plumb-Bob Designs
- ▶ Manual/Automatic Operation
- ▶ Unaffected by Airborne Dust or Acoustic Noise
- ▶ Plastics, Chemicals, Cement, Sand, Powders, Aggregates, Liquids and Many More

- ▶ Continuous Level Monitoring of Materials in Silos, Tanks and Other Storage Vessels
- ▶ Nominal Measuring Range up to 230 ft. (contact factory)
- ▶ Ideal for Applications Requiring Non-Contact Measuring with Frequent Level Changes
- ▶ Remote Monitoring Available
- ▶ Cement, Plastics, Grain, Sand, Flour, Limestone and Many More Applications

## TURCK: Delivering Advanced Automation Products

As the market for automation components continues to evolve and requires smarter, smaller, more robust sensing and productivity products, **TURCK** is rising to meet these challenges with a complete offering of automation components. Established as the industry's leading brand in proximity sensors, the **TURCK** name is synonymous with high-quality, rugged sensing products. Now users can expect that same quality in an expanded offering of automation products that will help improve their processes and profits.

## A Digital Read Out Flow Sensor for Your Flow Monitoring Applications

The rugged design and high repeatability of **TURCK's** Digital Read Out (DRO) flow sensor brings a new level of reliability to flow monitoring. This self-contained, fully programmable sensor allows for both flow and temperature monitoring, and features a highly visible three-digit display that can alternate between flow rate and media temperature when required.

The DRO flow monitor allows the user to program set points specific to an application, and can be programmed to perform in many different media, such as water, glycol and Galden HT110. If the fluid is a glycol/water mix, the percentage of glycol can be selected so that the monitor can adjust to each unique application without the need for factory calibration. The DRO flow monitor has an adjustable filter to smooth out a variety of erratic flow conditions, and is able to monitor changes in flow as low as 0.2 gallons per minute (GPM) or as fast as 12 GPM.

This unique flow monitor can be programmed with two different set points to reflect flow rate. It can be programmed to have one set point monitor flow and one point monitor temperature. A model with 4 set points is also available, where two points monitor flow and two points monitor temperature. And an analog current monitor is available with one set point.

The DRO flow monitor also features programmable on and off time delay functions, and allows the user to define hysteresis for both the flow and temperature set points. It is manufactured with a standard **euromast**® M12 connector, has a pressure rating of 145 psi, and can be ordered with a number of different fluid connections; making the DRO flow monitor an economical solution for your demanding flow applications.



### Typical Applications:

- Weld Tip Protection
- Transformer Cooling
- Semiconductor Chamber Cooling
- Hot Roller Coolant

**Solid-State with No Intrusive or Moving Parts**

The DRO flow monitor is an in-line device that approximates flow rate without disrupting the flow. Typical flow monitors often need to be installed by a specialist so that the monitor is precisely oriented to the direction of flow. These devices are also prone to material build up, which can affect the accuracy of the monitor.

The DRO flow monitor is a solid-state device that operates on the calorimetric principle, resulting in a sensor with no moving parts that can break or become lodged in the pipeline. This technology, combined with the in-line mounting of the sensor, allows the DRO flow monitor to perform dependably in a variety of demanding applications without concern for flow restriction or expensive downtime.

**Product Features**

- Selectable Media Inputs
- Flow/Temperature Readout
- User Programmable Set Points
- User Programmable Keypad
- Mounts Directly Into Pipeline
- 3 Digit - Highly Visible Display
- Adjustable On and Off Delay
- Adjustable Filtering
- Low Pressure Drop
- Solid-State Device
- Stainless Steel Wetted Parts
- Password Protected Programming

**Selectable Media**

- Water
- Deionized Water
- Ethylene Glycol (0-70%)
- Galden® HT110
- Galden® HT135

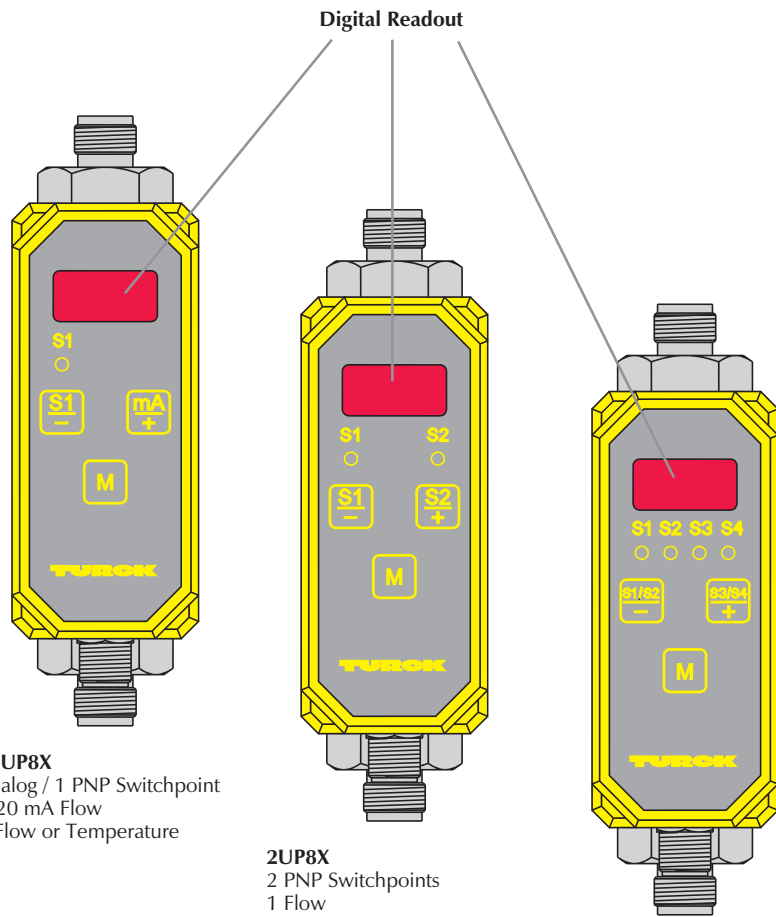

**LI-UP8X**  
Analog / 1 PNP Switchpoint  
4-20 mA Flow  
1 Flow or Temperature

**2UP8X**  
2 PNP Switchpoints  
1 Flow  
1 Flow or Temperature

**4UP8X**  
4 PNP Switchpoints  
2 Flow  
2 Temperature

## Flow Monitor Part Number Key

Part Number Keys are to assist in IDENTIFICATION ONLY.

### Insertion Probe Sensor

**FCS** - **N1/2** **A4P** - **AP8X** - **H1141** **Special Option Codes**

#### Sensor Type

FCS = Insertion Probe Flow Sensor  
 FCTS = Flow Sensor with Temperature Alarm

#### Fluid Connection

N1/2 = 1/2 NPT  
 N3/4 = 3/4 NPT  
 G1/4 = G1/4 (1/4 BSPP)  
 G1/2 = G1/2 (1/2 BSPP)  
 GL1/2 = G1/2 (1/2 BSPP with additional threading)  
 50 = 1.5 inch Tri-clamp

#### Housing

A4 = 316 Stainless Steel Housing and Probe  
 A2P = 303 Stainless Steel Probe with PBT Housing  
 A4P = 316 Stainless Steel Probe with PBT Housing  
 AL = 303 Stainless Steel Probe  
 HB = Hastelloy B  
 HC22 = Hastelloy C22  
 T = Dyflor (PVDF)  
 TN = Titanium w/B3 Coating

#### Electrical Connection

H1141 = *eurofast*®  
 H1140 = *eurofast*  
 B1151 = *minifast*®  
 B3141 = *microfast*®  
 B3151 = *microfast*

#### Circuitry

2AP8X = Dual N.O. PNP  
 AP8X = N.O. PNP  
 AN8X = N.O. NPN  
 ARX = N.O. Relay  
 RRX = N.C. Relay  
 LIX = 4-20 mA  
 NA = Remote (requires MK or MS 96)  
 NAEX = Intrinsically Safe

### Special Option Codes

**/A**

#### Modifier

/A = Airflow

**/L**

#### Probe Length

/L = Probe Length in mm

**/D..**

#### D Number

/D100 = +120°C (+248°F)  
 /D500 = 500 Bar Rating





## Flow Monitor Part Number Key

Part Number Keys are to assist in IDENTIFICATION ONLY.

### Inline Flow Sensor



#### Sensor Type

FCI = Inline Flow Sensor

#### Fluid Connection

- TC = Tubing Connection
- N1/8 = 1/8 NPT
- N1/4 = 1/4 NPT
- N3/4 = 3/4 NPT
- Blank = G1/4

#### Inline Diameter (millimeters)

- D03 = 3 mm
- D04 = 4 mm
- D06 = 6 mm
- D08 = 8 mm
- D09 = 9 mm
- D10 = 10 mm
- D11 = 11 mm
- D20 = 20 mm

#### Electrical Connection

- H1141 = **euromast**®, 4-pin
- H1140 = **euromast**, 4-pin
- H1160 = **euromast**, 6-pin

#### Circuitry

- AP8X = N.O. PNP
- AN8X = N.O. NPN
- ARX = N.O. Relay
- RRX = N.C. Relay
- LIX = 4-20 mA
- NA = Remote (requires MK or MS 96)
- NAEX = Intrinsically Safe
- 2ARX = Dual N.O. Relay

#### Housing

- A4 = 316 Stainless Steel
- A4P = 316 Stainless Steel with PBT Housing
- CTP = Ceramic / PTFE / PBT
- HC22 = Hastelloy C22

### Special Option Codes



#### D Number

- /D038 = 3/8 in. Tubing Connection
- /D201 = 3/8 in. Tubing Connection, Digital Readout, water or water/glycol mix
- /D203 = 3/8 in. Tubing Connection, Digital Readout, water only
- /D205 = 1/2 in. Tubing Connection, Digital Readout, water or water/glycol mix
- /D209 = 3/4 in. Tubing Connection, Digital Readout, water or water/glycol mix

**Flow Monitor Part Number Key**

Part Number Keys are to assist in IDENTIFICATION ONLY.

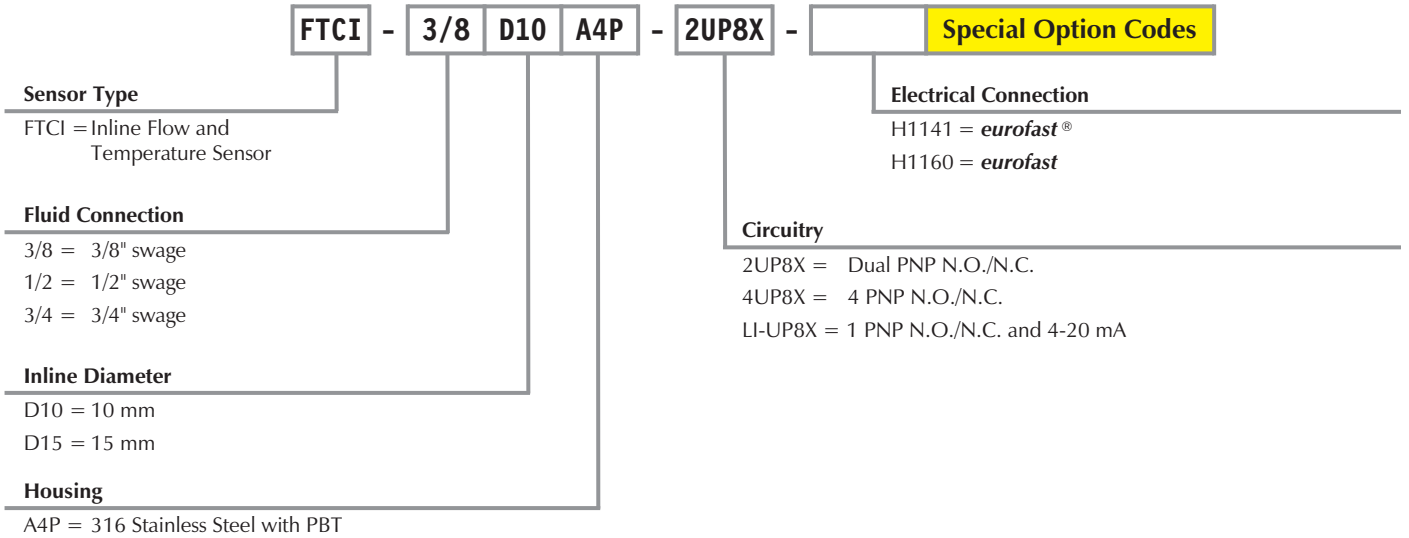



Housing Style	Part Number	ID Number	Flow Detection Range (GPM)	Temperature Monitoring Range (°F)	Output 1: Flow	Output 2: Temperature or Flow
<p><b>Inline Flow Monitor, Digital Readout, 3/8" Tubing Connection</b></p>	FTCI-3/8D10A4P-2UP8X-H1141	M6870806	0.2 to 4	+14 to +194	PNP N.O./N.C.	PNP N.O./N.C.
<p><b>Inline Flow Monitor, Digital Readout, 1/2" Tubing Connection</b></p>	FTCI-1/2D10A4P-2UP8X-H1141	M6870807	0.2 to 5	+14 to +194	PNP N.O./N.C.	PNP N.O./N.C.
<p><b>Inline Flow Monitor, Digital Readout, 3/4" Tubing Connection</b></p>	FTCI-3/4D15A4P-2UP8X-H1141	M6870808	1 to 12	+14 to +194	PNP N.O./N.C.	PNP N.O./N.C.

**Compatible Fluids:** Water, Deionized Water, Ethylene Glycol (0-70%), Galden® HT110, Galden® HT135

**Material**

Housing	PBT
Wetted Parts	316 Ti Stainless Steel
O-Ring	FKM



Voltage	Current Consumption (mA)	Switching Current	Pressure Rating (psi)	Fluid Connection	Operating Temp. (°C) (ambient)	Protection	Mating Cordset	Wiring Diagram #	Wiring Diagrams
21.6-26.4 VDC	≤100	200	290	3/8" swage	0 to +60	IP 65	RK 4.4T-*	1	<p>Diagram 1</p>
21.6-26.4 VDC	≤100	200	290	1/2" swage	0 to +60	IP 65	RK 4.4T-*	1	
21.6-26.4 VDC	≤100	200	290	3/4" swage	0 to +60	IP 65	RK 4.4T-*	1	

\* Length in Meters.





From \$389.00

**FCS-N1/2 A4-AP8X-H1141**  
**FCS-G1/2 A4-AP8X-H1141**

- All stainless steel housing
- DC PNP/NPN transistor output, short-circuit protected
- Flow monitor and signal processor in one compact housing
- Dynamic pressure resistance up to 870 psi
- Simple adjustment by means of potentiometer



From \$469.00



**FCS-50A4-NA/D014**  
**FCS-50A4-AP8X-H1141/D014**

- Flow monitors for dairy applications in the food and beverage industry
- Dynamic pressure resistance up to 145 psi
- 316L stainless steel housing

See Section 1  
for Turck Capacitive



From \$247.00

**FCS-N1/2 A4-NA-H1141**  
**FCS-N3/4 A4-NA-H1141**  
**FCS-G1/4 A4-NA-H1141**  
**FCS-GL1/2 A4-NA-H1141/D500**  
**FCS-G1/2 TN-NA-H1141**  
**FCS-G1/2 HC22-NA**  
**FCS-G1/4 A4-NA/D100**  
**FCS-N1/2 A4-NA/D100**  
**FCS-N1/2 T-NA**  
**FCS-N3/4 T-NA**

- Remote switch to be used with separate signal processor
- Dynamic pressure resistance:
  - Standard: up to 1450 psi
  - Extended: up to 7250 psi
- Temperature range:
  - Standard: 13° to 176°F
  - Extended: 32° to 212°F
- Housing material: 316TI stainless steel



From \$446.00

**FCS-G1/4 A4-ARX-H1140**

- All stainless steel housing
- Flow monitor and signal processor in one compact housing
- Dynamic pressure resistance up to 870 psi
- Simple adjustment by means of potentiometer
- Relay output for 60 VDC/1 A, N.O.



From \$299.00

### MK96-11-R/24 VDC

- Signal processors for insertion style and in-line flow monitors
- One normally open dry contact
- 18 mm wide terminal housing
- Finger protection according to VGB 4 and VDE 0470, Part 1
- Simple switching setpoint calibration with potentiometer
- Six LEDs to indicate flow conditions

From \$753.00

### MS96-11Ex-R...

- Remote signal processor for Ex insertion-style flow monitors
- Intrinsically safe input circuit for Zone 1 [EEx ib] II C
- One SPDT relay output for flow control
- Six LEDs for flow indication
- Wire-break monitoring
- Built-in switch OFF delay, from 0 to 25 seconds



From \$500.00

### MK96-LI01

- Signal processor for insertion and in-line style flow monitors
- Current output from 4 to 20 mA
- 18 mm wide terminal housing
- Finger protection according to VGB 4 and VDE 0470, Part 1
- Simple zero and span calibration with two potentiometers
- Six LEDs to indicate output status



From \$203.00

### MK96-VP01 MK96-VN01

- Remote signal processor for insertion and in-line style flow monitors
- Two complementary, short-circuit protected PNP/NPN transistor outputs
- 18 mm wide terminal housing
- Simple switch set point calibration with potentiometers
- Six LEDs to indicate flow conditions

From \$270.00

### MS96-12R...

- Remote signal processor for use with insertion and in-line style flow monitors
- Units available for 115 VAC or 24 VDC
- Two SPDT relay outputs for flow and temperature control
- Six LEDs for flow indication
- Wire-break monitoring
- Adjustable temperature control over -20° to +100°C (-4° to +212°F) range
- Built-in switch OFF delay, from 0 to 25 seconds

