

numatics
motors

NT Series

Servo Motors and Control Packages



numatics®

NT Series Motors and Drives	3-17
Feature & Benifets.	3
Eb Base Drive	4-5
Ei Indexing drive	6-7
Ei-DN DeviceNet-ready.	8
Epsilon Drive Terminals & Pinouts	9
Drive Specifications and Dimensional	10
How to Order.	11
Motor Selection.	12
Motor Specifications.	13-14
NT Motor Dimensions	15
Cable & Accessories	16
Operator Interface Panel	17
Servo Systems Inline Gearboxes	18-19
Servo Systems Shaft Coupler Ordering	20



Epsilon Compact and Economical

The Epsilon Series is the most compact digital servo drive in the Numatics lineup. Designed to fit in cabinets as small as six inches (152mm) deep, with cables attached, Epsilon drives possess rugged quality and reliability.

There are three sizes of each Epsilon drive: 2 Amp, 3 Amp and 5 Amp, with the largest drive delivering up to 37 lb-in continuous torque. Each drive contains a 14-segment status display, reset button, removable connectors and utilizes standard “D” type connectors.

Features

- 90 to 264 VAC 1Ø input power
- Up to 37 lb-in continuous torque
- Drive options: Base, Indexing, and Indexing with DeviceNet
- Easy install, setup and operation
 - Compact, space saving design, six-inch (152mm) panel depth including cables
 - Pluggable connectors, Standard D-Shell and Screw Terminals
 - State-Space Observer Control, which allows 10-1 inertia mismatch out of the box, and 50-1 with tuning
- Free ServoPro software, and upgrades
- Programmable, optically-isolated I/O
- RS-232/485 serial communication interface using Modbus protocol
- 14-segment status and diagnostic display, time-stamping of last 10 faults for easy troubleshooting
- Field programmable flash memory firmware (upgrades are free)
- Auto-Tune support for any servo motor with encoder feedback
- 24VDC auxiliary input for logic backup



The Epsilon is available as a base drive, the Epsilon Eb; or as a single-axis positioning drive, the Epsilon Ei. The Epsilon Ei is also available as DeviceNet-ready drive, the Epsilon Ei-DN.

The Epsilon is very easy to commission and program using ServoPro software. This Windows-based programming environment makes extensive use of drag and drop editing, tabbed setup screens and hierarchical views. ServoPro is used to select the operating mode and motor, configure I/O, set velocity limits and torque levels, and monitor drive and I/O Status.

The Base drive can be configured in seven operating modes: Analog Torque, Analog Velocity, Preset Velocity, Preset Velocity + Analog Velocity, Pulse/Pulse, Pulse/ Direction and Pulse/Quadrature. For positioning, the indexing version is your choice. The indexing drive gives you 16 Indexes with chaining and linking capability, jogging, a multitude of homing routines, and user units.

Communication is done via RS-232 or RS-485 Modbus RTU. DeviceNet is available as an option on the indexing model, Ei-DN. The Epsilon is designed to run with Numatics NT motors and can easily be configured for use with any third party motor.





Epsilon Drives

Epsilon Eb Base Drive Operation

The Epsilon Series Eb Drive is a compact drive that is ideal for use with single and multi-axis controllers, PLCs and host controllers. The analog torque or velocity modes can be used with classic position controllers using analog outputs and encoder inputs. The pulse mode is ideal for use with low-cost PLC stepper controllers. This drive works in a variety of applications where a host control provides a command signal determining the desired motion profile.

The Eb Drive is configurable for seven flexible modes of operation, and the parameters for each mode can be adjusted to tailor the drive to the specific application using Windows-based ServoPro software.



- Analog Torque Mode
- Analog Velocity Mode
- Digital Velocity Preset
- Pulse Mode
 - Pulse/Pulse
 - Pulse/Direction
 - Pulse/Quadrature
- Summation of Analog Velocity and Digital Velocity

Features

- Programmable I/O
 - 5 optically-isolated inputs (1 dedicated)
 - 3 optically-isolated outputs
 - 1 analog input ± 10 VDC, 14 bit
 - 2 analog output ± 10 VDC, 10 bit
- Programmable encoder output, (up to 2,048 lines per revolution)
- Separate stop and travel limit decel ramps
- Torque, Travel, Following Error and Velocity Limits
- 8 user defined speed presets with individual accel/decel rates
- 2 Programmable Torque Level Outputs
- In Motion Velocity Output
- Software Oscilloscope

Standard Control Modes

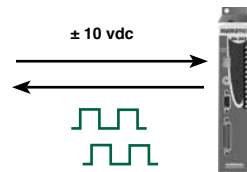

Analog Velocity/Torque Mode

- MC
- Position Controller

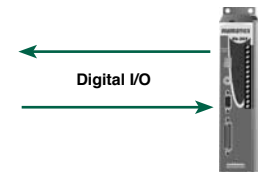

Digital Velocity Preset

- PLC
- User Logic

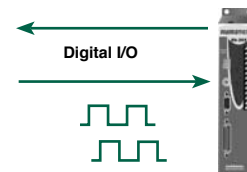

Pulse Mode

- PLC
- Master Axis
- Synchronized Encoder

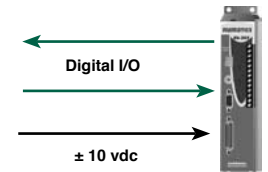

Summation of Analog Velocity and Digital Velocity

- PLC
- User Logic
- Analog Trim



Epsilon Drives

The operating mode of the drive is simply selected with one click in the ServoPro Detailed Setup tab.

Pulse Mode

In Pulse Mode the drive will receive pulses from a master source (single-ended or differential), which can be interpreted in three ways:

- Pulse/Pulse
- Pulse/Direction
- Pulse/Quadrature

Application Examples

- PLC pulse command outputs
- Electronic
- Stepper drive replacement
- Web line ratio control

Velocity Mode

Analog— In Analog Velocity Mode the drive develops a velocity command in proportion to the voltage (± 10 VDC) received on the Analog Input. *Note: Analog full scale voltage and offset are programmable.*

Preset Velocity— In this mode one of up to eight digital velocities can be selected using the digital I/O or Modbus. Each preset has its own accel/decel ramps.

Application Examples

- Clutch-brake replacement
- Phase control with a differential
- Automatic feed control for machining operations
- Spindle speed control

Velocity Summation— This mode combines the features of Analog Velocity and Preset Velocity in one mode. It allows running a preset velocity and trimming it with an analog input, or vice versa, allowing advanced applications to be solved simply and elegantly without complex controllers.

Application Examples

- Loop/dancer arm control
- Phase advance/retard
- Speed trimming

Application Examples

- Loop/dancer arm control
- Phase advance/retard
- Speed trimming

Torque Mode

In Analog Torque Mode the drive develops a torque command in proportion to the the voltage (± 10 VDC) received in the Analog Input. *Note: Analog full scale voltage and offset are programmable.*

Application Examples

- With Position/Velocity Controller
- Tension Control

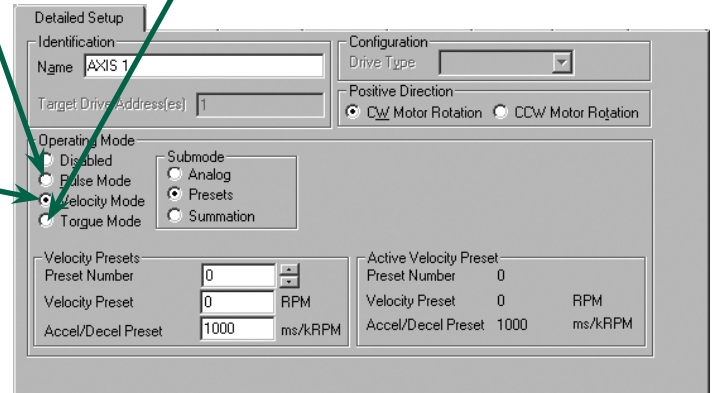

Flexible I/O Functionality

The digital I/O of the drive is completely programmable with the ability to map one or more I/O functions to the I/O points.

Output Functions

- Drive OK
- At Velocity
- Travel Limits (+)
- Travel Limits (-)
- In Motion (+)
- In Motion (-)
- Power Stage Enabled
- Torque Limit Active
- Velocity Limiting Active
- Fault
- Brake
- Shunt Active
- Torque Level 1 & 2 Active
- Foldback Active

Input Functions

- Stop
- Reset
- Travel Limit (+)
- Travel Limit (-)
- Torque Limit Enable
- Torque Mode Enable
- Velocity Presets
- Brake Release
- Brake Control



Epsilon Drives

Epsilon Ei Compact Indexing Drive

The Epsilon Series Ei (Indexing) Drive offers user units, indexing, homing and jogging, and additional I/O in a package that is the same compact size as the base Epsilon Eb Drive. Operating information is setup via a PC. These setup parameters are easily entered and stored with the use of our feature filled Windows-based ServoPro software. The setup can be downloaded, stored on disk or printed out for documentation. The ease-of-use saves time and money during installation and makes long term support a breeze.

User Units

Using ServoPro, the Ei is easily programmed. Homes, Jogs and Indexes are set up using units representative of the application. This allows for an easy translation of motor revolutions to rotary, linear or other units. Once the desired user units are entered into the Units tab, all motion will be based on units specific to the application—not arbitrary units requiring conversion.

Features

- Programmable I/O
 - 12 optically-isolated inputs
 - 7 optically-isolated outputs
- 16 indexes
 - Chaining index capability
 - Chain indexes to home
- Jogging and Homing
 - 2 jog velocities
 - Homing
 - Home to sensor
 - Home to marker
 - Home to sensor/marker
- Alternate Mode
 - Analog Velocity
 - Analog Torque (with Speed Limit)
 - Pulse Mode
- Optional DeviceNet Version—Ei-DN
- User Units
 - Distance
 - Velocity
 - Time Scale
 - Acceleration



Indexing

The Epsilon Ei drive is easily programmed to meet a wide variety of indexing requirements, either using our ServoPro software or with a Modbus Master. Sequencing multiple indexes is possible using the chaining command.

- 16 indexes —Incremental, Absolute, Registration, Rotary Plus, and Rotary Minus index types
- Parameters for Distance, Velocity, Accel/Decel, Dwell and Registration to Sensor or Torque Levels
- Chaining Options—Counts, Repeat Counts, Repeat Forever, Stop, Start Next Index, Wait for Run Next Input Function

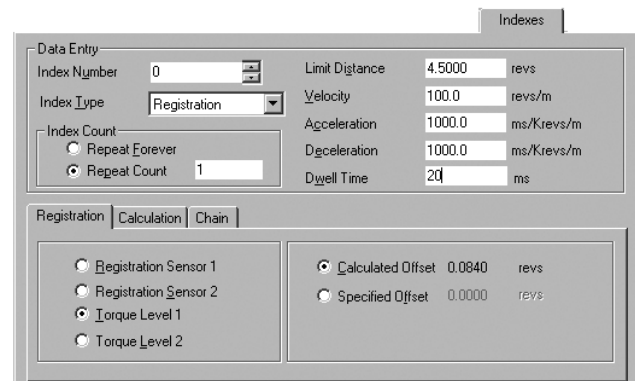

Jogging

The jogging function is comprised of two velocities with separate accel/decel ramps programmed in user units.

- Inputs: Jog +, Jog -, Jog Fast
- Parameters: Jog Velocity, Jog Fast Velocity, Accel and Decel

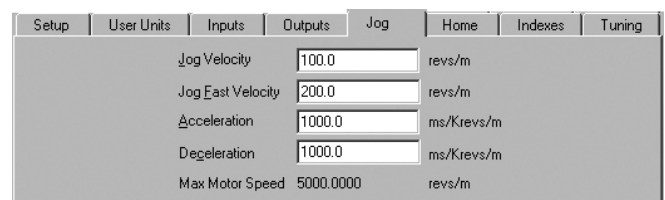



Homing

The Homing feature set in the Ei is very extensive. The large number of parameters gives the user added flexibility and simplifies setting homing functions.

- Home to Sensor, Marker, Sensor & Marker
- If on home sensor, then back off before homing, or go forward to next sensor
- Home Offset distance relative to sensor/marker
- Parameters for Velocity, Accel, Decel, Home Offset, End-of-Home Position and Limit Distance
- Chain to Index Number

Alternate Mode

Alternate mode adds base drive capabilities to the simple indexer. Users may achieve motions such as electronic gearing, analog signal following, and analog torque control using the alternate mode function while retaining the full functionality of a powerful indexing drive.

- Pulse Mode
In Pulse Mode the drive will receive pulses from a master source (single-ended or differential), which can be interpreted three ways:
 - Pulse/Pulse
 - Pulse/Direction
 - Pulse/Quadrature
 - Analog Velocity Mode
- In Analog Velocity Mode, the drive develops a velocity command in proportion to the voltage (± 10 VDC) received on the Analog Input. Note: Analog full scale voltage and offset are programmable.
- Analog Torque Mode
In Analog Torque Mode, the drive develops a torque command in proportion to the voltage (± 10 VDC) received on the Analog Input. Note: Analog full scale voltage and offset are programmable.

Flexible I/O Functionality

The digital I/O of the drive is completely programmable with the ability to map one or more I/O functions to the I/O points

Input Functions

Index Initiate
Index Select 0
Index Select 1
Index Select 2
Index Select 3
Run Next Index
Home Initiate
Home Sensor
Define Home
Stop
Jog +
Jog -
Jog Fast
Travel Limit +
Travel Limit -
Brake Control
Brake Release
Reset
Registration Sensor 1
Registration Sensor 2
Torque Limit Enable
Alternate Mode Enable

Output Functions

Absolute Position Valid
End of Index
End of Index Motion
End of Index Count
End of Chaining Counts
Registration Limit Distance Hit
Home Limit Distance Hit
End of Home
At Velocity
In + Motion
In - Motion
Drive OK
Fault
Brake
Travel Limit +
Travel Limit -
Foldback Active
Shunt Active
Torque Limit Active
Power Stage Enabled
Torque Level 1 Active
Torque Level 2 Active
Index In Position
Torque at Max Velocity



Epsilon Drives

Epsilon Ei-DN DeviceNet-Ready

Small size and large functionality makes the Epsilon Ei-DN a natural fit in any DeviceNet related motion application. The Ei-DN retains the same footprint as the Ei and now uses Polled I/O and Explicit Messages to change or initiate any user parameter in the drive via DeviceNet. Choose between any one of four predefined DeviceNet word setups.

- **Index Select Predefined**
(Static DeviceNet Word Block, full Ei features)
- **Index Select Userdefined**
(Dynamic DeviceNet Word Block, full Ei features)
- **Index Type** (Position Control with Ei functionality)
- **Position Control** (Position Control only)

Features

- Supports Explicit Messaging
- Polled (8 bytes in, 8 bytes out)*
- Access to all Motion Parameters within Polled I/O.
- Up to 63 devices per network
- Baud Rate (125k, 250k, 500k) and MacID configurable via Servo Pro or the “one-touch” reset button
- Module and Status LEDs located on the front of the drive
- 25 milliamp DeviceNet draw
- Easy 5-wire terminal block for DeviceNet connection

*In and Out refers to PLC Inputs and Outputs

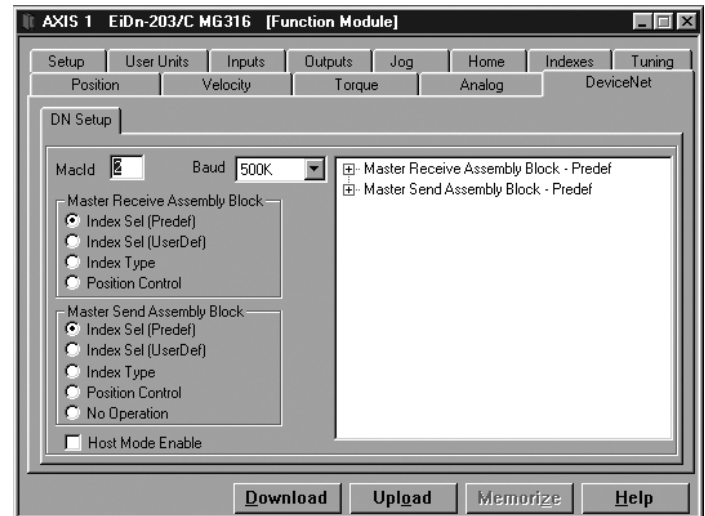

Change the nature of the pre-configured assembly blocks by simply changing the mapping of the DN bits. The DN Bits are user defined bits that can have different I/O functions mapped to them.

ServoPro includes the most advanced diagnostic interface on the market for display of network data. When online, with Servo Pro, the online DeviceNet tab gives the user a view of the actual data that is being sent and received through the DeviceNet network. Watch functions turn on and off over DeviceNet right in ServoPro. Look at transmit and receive message counters, check the established connections, even look at the current baud rate, MacID and Master MacID.

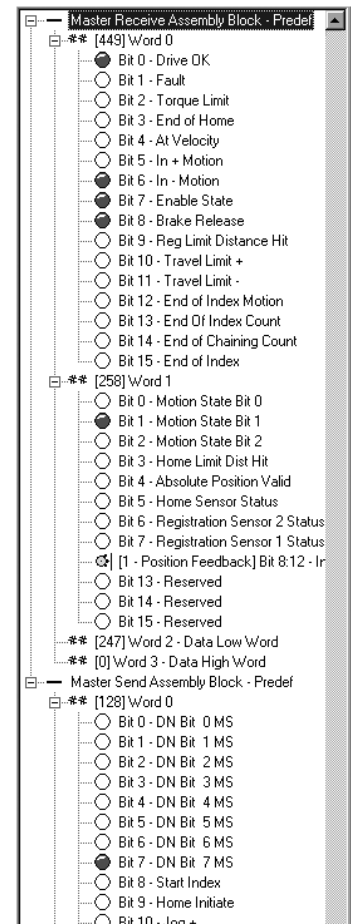



Epsilon Drive Terminals and Pinouts

Serial (J4)	
Pin Number	Signal
3	RS-232 TX
2	RS-232 RX
6	Serial +5VDC
5	Serial OV Common
4	RS-485+
9	RS-485-
1	Shield
7,8	No Connect

DeviceNet (Ei-DN Only)	
Pin Number	Signal
1	V-
2	CAN_L
3	Drain
4	CAN_H
5	V+

Command (J5)	
Pin Number	Signal
15	Analog Command In +
14	Analog Command In -
8	Encoder Out A
9	Encoder Out A/
23	Encoder Out B
24	Encoder Out B/
37	Encoder Out Z
38	Encoder Out Z/
27	Pulse In A
41	Pulse In A/
26	Pulse In B
40	Pulse In B/
25	Pulse In Z
39	Pulse In Z/
20	Pulse In A (single ended)
36	Pulse In B (single ended)
16	I/O Input Drive Enable
1	I/O Input 1
2	I/O Input 2
3	I/O Input 3
4	I/O Input 4
19	I/O Output 1
18	I/O Output 2
17	I/O Output 3
33	I/O Supply +
34	I/O Supply +
31	I/O Supply 0V
32	I/O Supply 0V
29	Analog Out 0V
43	Analog Out Channel 1 +
44	Analog Out Channel 2 +
11	External Encoder +5VDC Power
12	External Encoder Common
28	+15V Power Out (10 mA)
6	RS-485 +
21	RS-485 -
5, 7, 10, 13, 22, 35, 30, 42	No Connect

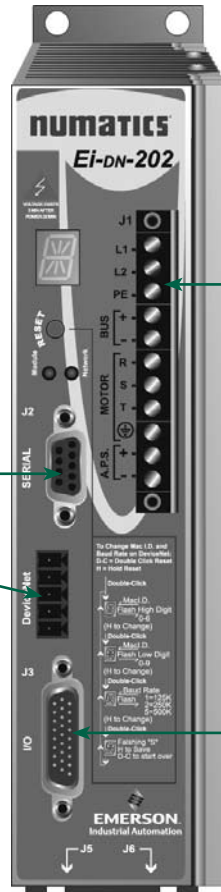

Power (J1)	
Terminal	Signal
L1	AC Input L1
L2	AC Input L2
PE	AC Ground
Bus +	DC Bus +
Bus -	DC Bus -
Motor R	Motor Power Brown Wire
Motor S	Motor Power Black Wire
Motor T	Motor Power Blue Wire
±	Motor Power Ground
A.P.S. +	Logic Supply Backup +24VDC
A.P.S. -	Logic Supply Backup 0V Common

Digital I/O (J3)	
Pin Number	Signal
1	Input 1
11	Input 2
2	Input 3
12	Input 4
3	Input 5*
13	Input 6*
4	Input 7*
14	Input 8*
5	Input 9*
15	Input 10*
6	Input 11*
16	Input 12*
10	Drive Enable
19	I/O Supply +
20	I/O Supply 0V
7	Output 1
17	Output 2
8	Output 3
18	Output 4*
9	Output 5*
25	Output 6*
26	Output 7*
21-24	No Connect

*Indexing Versions Only

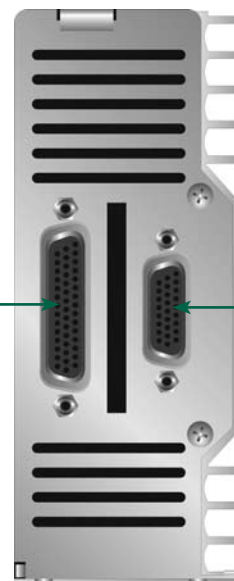

Feedback (J7)	
Pin Number	Signal
1	Motor Encoder A
10	Motor Encoder A/
2	Motor Encoder B
11	Motor Encoder B/
3	Motor Encoder Z
12	Motor Encoder Z/
4	Motor Commutation U
13	Motor Commutation U/
5	Motor Commutation V
14	Motor Commutation V/
6	Motor Commutation W
15	Motor Commutation W/
7,8	Encoder +5VDC Supply
17	Encoder 0V Common
9	Motor OverTemp
16,18-26	No Connect



Epsilon Specifications and Dimensions

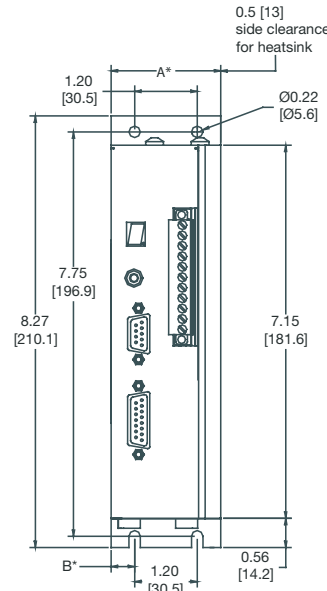
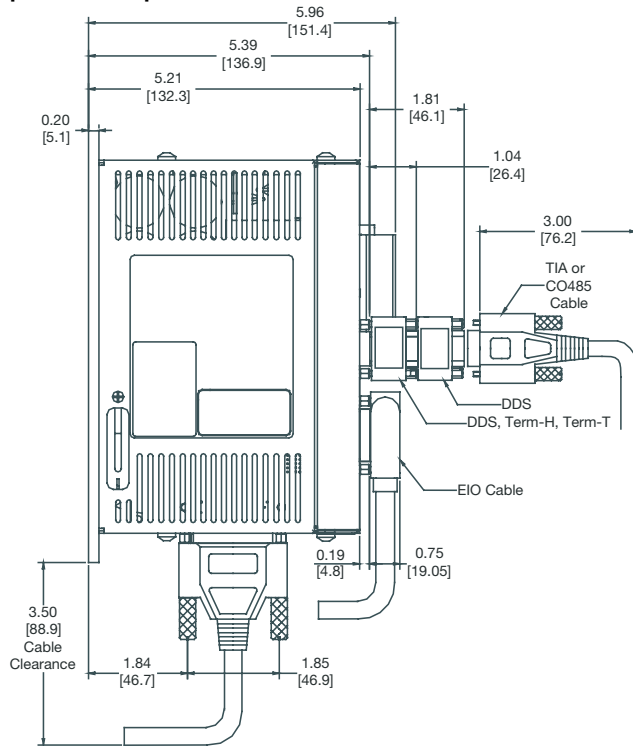

Drive Model	Dimension A	Dimension B
*-202	2.10 [53.3]	.45 [11.4]
*-203	2.10 [53.3]	.45 [11.4]
*-205	3.56 [90.42]	.70 [17.78]

Power Requirements

AC Input Voltage: 1Ø, 90 to 264 VAC, 47 - 63 Hz (240 VAC for rated performance)

AC Input Current

- 202: 4.3Arms (140A for 2ms inrush)
- 203: 6.5Arms (140A for 2ms inrush)
- 205: 10.8Arms(140A for 5ms inrush)

Output Continuous Current (RMS)

- 202: 1.8Arms
- 203: 3Arms
- 205: 5Arms

Output Peak Current (for 4 seconds)

- 202: 3.6A
- 203: 6A
- 205: 10A

Continuous Output Power

- 202: 0.7kW
- 203: 1.2kW
- 205: 2.0kW

Switching Frequency 20 kHz

Logic Supply Internal

Auxiliary Logic Supply +18 to 30 VDC @ 0.5A

Encoder Supply Output +5 VDC, 250 mA

System Efficiency 93%

Cooling Method

- 202: Convection
- 203: Convection
- 205: Convection

Regeneration

Internal Energy Absorption (115V)

- 202: 41 Joules
- 203: 41 Joules
- 205: 113 Joules

Internal Energy Absorption (230V)

- 202: 18 Joules
- 203: 18 Joules
- 205: 48 Joules

External: Connection to RSR-2 with external resistor, 20 Ohm min, 15 Arms, 2kW

Drive Control Inputs

Analog: (1) +/-10VDC, 14 bit, 100kOhm, Differential

Analog Max. Input Rating: Differential +/-14 VDC, Each Input with Reference to Analog Ground +/-14VDC

Digital: (5) +10 to 30 VDC, 2.8kOhm, Sourcing, Optically Isolated

Pulse: (1) Differential Rs-422, 2MHz/Channel, 50% Duty Cycle

Single Ended: (1) TTL Schmitt Trigger 1MHz/Channel, 50% Duty Cycle

Motor Overtemperature: 0 to +5VDC, 10kOhm, single ended

Drive Control Outputs

Analog: (2) +/-10VDC, 10 bit, Single-ended 20mA

Digital: (3) +10 to 30VDC, 150mA, Sourcing Optically Isolated

Pulse: Differential RS-422 and TTL compatible, 20mA/Channel Sink or Source

I/O Supply: +10 to 30 VDC

Environmental

Rated Ambient Temperature: 32° to 104°F (0° to 40°C) for rated performance

Maximum Ambient Temperature: 32° to 122°F (0° to 50°C) with power derating of 3.5%/1.8F (1°C) above 104°F (40°C)

Rated Altitude: 3280' (1000m)

Maximum Altitude: For altitudes >3280' (1000m) derate output by 1%/328' (100m)

Vibration: 10 to 2000 Hz @ 2g

Humidity: 10 to 95% non-condensing

Storage Temperature: -13° to 167°F (-25° to 75°C)

Ingress Protection: IP-20

Serial Interface

RS-232/RS-485 Modbus RTU w/ 32-bit extension — 9600 to 19.2 kBaud

Internal RS-232 to RS-485 Converter

Drive Weight

- 202: 3.3 lb (1.5 kg)
- 203: 3.3 lb (1.5 kg)
- 205: 3.7 lb (1.7 kg)

DeviceNet (Optional)

Power Consumption: 25mA
Baud Rates: 125, 250 and 500kps
Node Addresses: 00-63
Messaging: Explicit and Polled I/O



How to Order

Use one of the next few pages to configure a basic Epsilon system by selecting one item from each of the four ordering columns, and the fifth column if you are choosing a brake motor. Items **3** through **5** require cable lengths to be provided. The basic systems represented on these pages can be customized with a variety of components depending on your needs. A guide to Epsilon Options and Accessories can be found at the end of this page.

Select System and Motor

1 Select the Epsilon drive appropriate to the needs of your application and operating environment, either Eb (base), Ei (indexing) or Ei-DN (indexing with DeviceNet support), and the size of drive, 2-Amp, 3-Amp or 5-Amp Epsilon (202, 203 and 205, respectively).

2 Select a motor for your drive. The system selection matrix for NT motors is found on the next page.

Cable Ordering Options

Motor power, feedback and brake cables are fully shielded with IP-65 molded connectors and are available in standard and custom lengths. For more information on these and other cables, see Cables and Accessories section.

Standard lengths of 15, 25 and 50 feet are available from stock. Non-standard lengths require additional lead time.

When ordering, replace xxx with specified length in feet (i.e. 015 = 15 ft). For applications involving continuous flexing, flexible cables are available.

3 Motor power cables
CMDS-xxx 16 AWG for 2-3" motors; connector on motor end, ferrules on drive end

4 Motor Feedback Cables
CFCS-xxx Connectors on both ends.

5 Motor Brake Cable
CBMS-xxx Required for all motors with brake option; connector on motor end only.

Software is Free!

The Numatics ServoPro Programming software is shipped with every product. Software updates are free and can be downloaded from our website, as are firmware updates.

Epsilon Options and Accessories

Numatics provides a complete array of options and accessories to complete your system. See accessories section for more information.

Brake Relay

BRM-1

Breakout Board

ECI-44, STI-EIO

Auxiliary Logic Supplies

MLP-002-00, MLP-005-00 and MLP-010-00

External Shunts/Resistors

RSR-2, ES-20-500, ES-20-1K, ES-20-2K, ES-30-1K, ES-30-2K, MS-530-00-000

AC Line Filters

960307-01

Synchronization Encoders

SCSLD-4, SCSLD-4R

Operator Interface

OIT



NTE Motors & Drives

Epsilon 120-240V NT Motor Selection

The NT motor is a high performance motor utilizing patented technology to maximize torque in a compact package. The NT motor uses powerful Neodymium magnets and manufactured with a segmented core to maximize stator efficiency. The NT motor has a very low inertia for applications that demand high accel and cycle rates. NT motors are available in English (NEMA 23 or 34) flanges, with or without brakes. The standard encoder resolution is 2048 lines per rev. NT motors are supplied with MS style connectors.

NT Motor How To Order

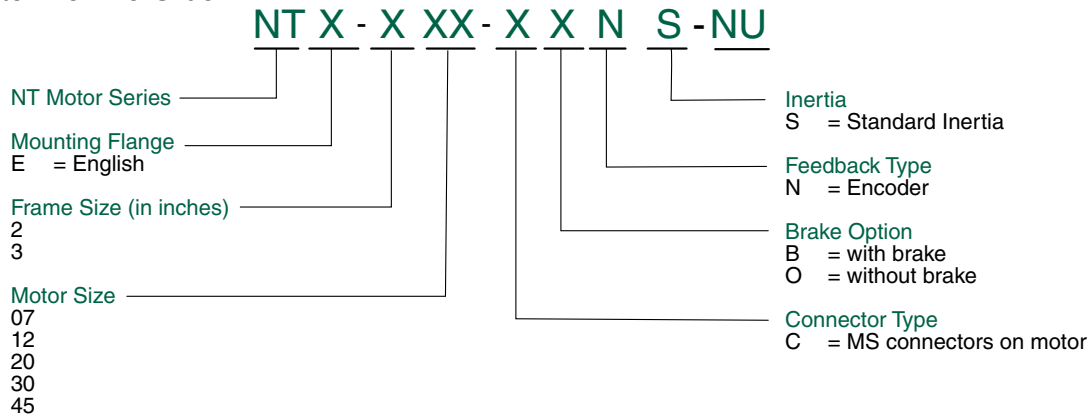

For additional motor information see Motors. For additional Cable options see Cable & Accessories page 16.

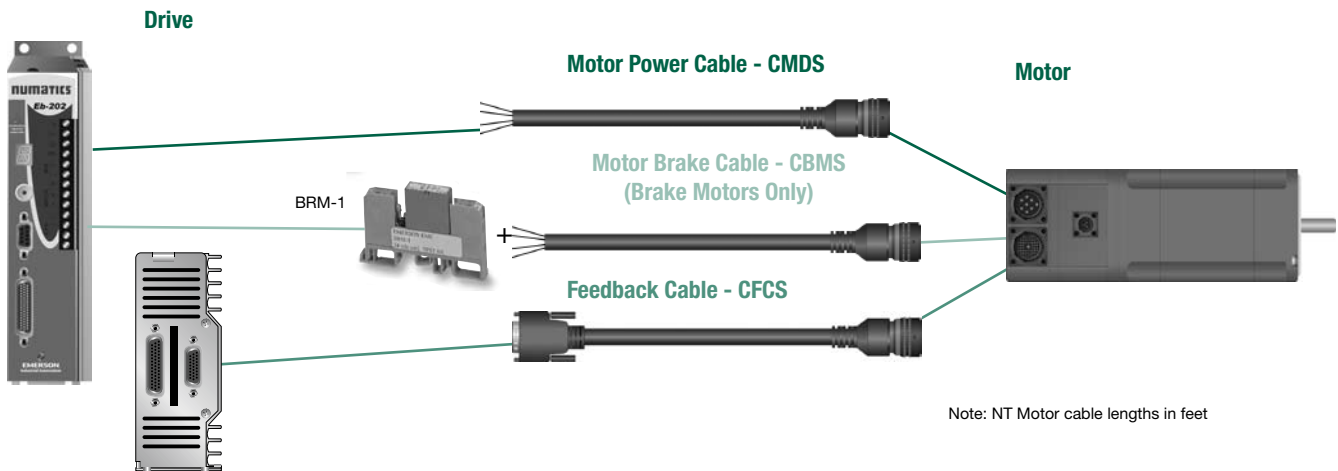

1 Epsilon Servo Drive (* = Eb, Ei or Ei-DN)	2 NT Servo Motor	3 Motor Power Cable (xxx=feet)	4 Feedback Cable (xxx=feet)	5 Motor Brake Cable* (required w/ all brake motors) (xxx=feet)
*-202-NU-000	NTE-207-CONS-NU	CMDS-xxx	CFCS-xxx	
*-202-NU-000	NTE-207-CBNS-NU	CMDS-xxx	CFCS-xxx	CBMS-xxx
*-202-NU-000	NTE-212-CONS-NU	CMDS-xxx	CFCS-xxx	
*-202-NU-000	NTE-212-CBNS-NU	CMDS-xxx	CFCS-xxx	CBMS-xxx
*-203-NU-000	NTE-212-CONS-NU	CMDS-xxx	CFCS-xxx	
*-203-NU-000	NTE-212-CBNS-NU	CMDS-xxx	CFCS-xxx	CBMS-xxx
*-205-NU-000	NTE-320-CONS-NU	CMDS-xxx	CFCS-xxx	
*-205-NU-000	NTE-320-CBNS-NU	CMDS-xxx	CFCS-xxx	CBMS-xxx
*-205-NU-000	NTE-330-CONS-NU	CMDS-xxx	CFCS-xxx	
*-205-NU-000	NTE-330-CBNS-NU	CMDS-xxx	CFCS-xxx	CBMS-xxx
*-205-NU-000	NTE-345-CONS-NU	CMDS-xxx	CFCS-xxx	
*-205-NU-000	NTE-345-CBNS-NU	CMDS-xxx	CFCS-xxx	CBMS-xxx



Epsilon-NT Motor Specifications

Drive Model (*=Eb,Ei or Ei-DN)	Motor Model	Cont.Stall Torque lb-in Nm	Peak Stall Torque lb-in Nm	Rated Torque @Rated Speed* lb-in Nm	Rated Power HP KWatts	Max.* Operating Speed RPM	Encoder Resolution lines/rev	Inertia lb-in-sec2 kg-cm2	Motor Ke Vrms/krpm	Motor Kt lb-in/Arms Nm/Arms	Motor Weight lb kg
*-202	NT-207	7.3	15.2	6	0.48	5000	2048	0.000094	35	5.12	3
		0.83	1.72	0.68	0.36						
*-202	NT-212	8.7	17	8.4	0.71	5000	2048	0.000164	35	5.12	4
		.98	1.92	0.95	0.53						
*-203	NT-212	12.5	27	11.8	0.75	5000	2048	0.000164	35	5.12	4
		1.4	3.05	1.3	0.56						
*-205	NT-320	19	29	18.8	1.19	4000	2048	0.000328	29	3.50	6
		2.1	3.28	2.1	0.89						
*-205	NT-330	26	44	26	1.24	4000	2048	0.000438	36	5.04	7.3
		2.9	4.97	2.9	0.92						
*-205	NT-345	37	65	36	1.71	3000	2048	0.000668	50	7.13	10
		4.2	7.34	4.1	1.28						

* Rated Speed = Maximum Operating Speed

Epsilon-NT Motor Speed Torque Curves

* Epsilon Drive: Epsilon Eb (base), Epsilon Ei (indexing), or Epsilon Ei-DN (indexing with DeviceNet support).

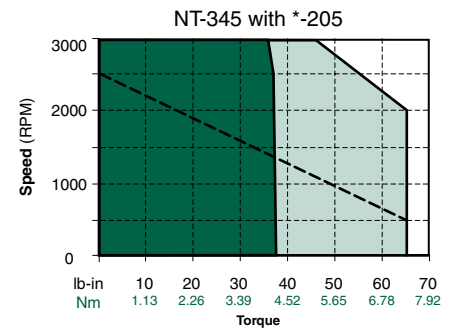
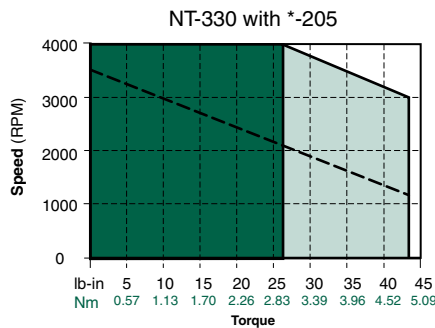
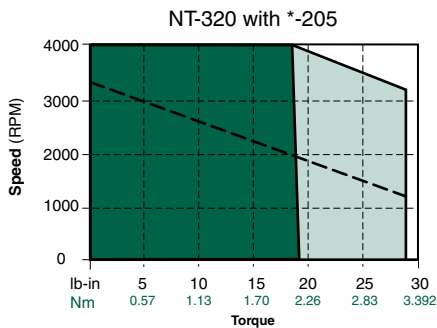
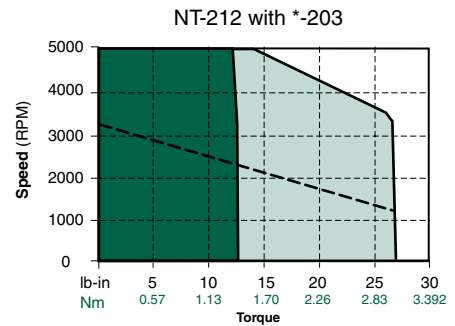
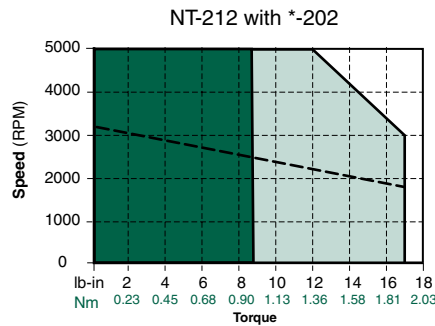
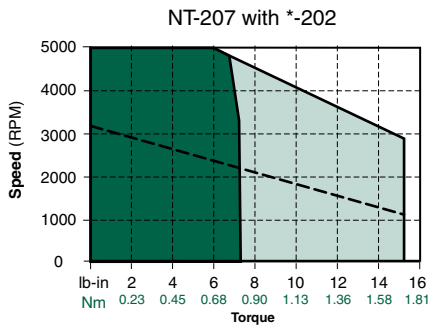

Legend

- 120V Curve
- Continuous Torque
- Peak Torque

Performance Specifications

Voltage: 240 VAC
 Drive Frequency: 20kHz
 Ambient Temperature: 25°C (77°F)
 Case Temperature: 100°C (212°F)

All performance data listed above has a +/-10% tolerance and is subject to change at any time without notice. For more detailed information on performance data and test conditions please refer to the motor section of the catalog. For brake motor information, complete motor specifications and dimensions please refer to our motor section.



Servomotors NT

NT Motor—240V

The NT Motor is an economical, high performance motor manufactured with patented technology to maximize torque and minimize size. The NT motor uses powerful Neodymium magnets and is manufactured with a segmented core to maximize stator efficiency and further reduce size. The NT motor has a very low inertia for applications that demand high accel and cycle rates. When used with the Epsilon Drives the NT line produces from 7lb-in (0.79Nm) to 37lb-in (4.1Nm) of continuous torque. NT motors are available in English (NEMA 23 or 34) flanges, with or without brakes. The standard encoder resolution is 2048 lines per rev. NT motors are supplied with MS style connectors. All motors are rated IP65.



NT Motor Specifications

Motor Model	Cont.Stall Current Arms	Peak Current Arms	Motor Resistance Ohms	Motor Inductance mH	Max.* Operating Speed RPM	Encoder Resolution lines/rev	Inertia lb-in-sec ² kg-cm ²	Motor Ke Vrms/krpm	Motor Kit lb-in/Arms Nm/Arms	Motor Weight lb kg
NT-207	1.7	3.6	11.1	39.1	5000	2048	0.000094 0.106	35	5.12 0.58	3 1.36
NT-212	2.7	6	4.56	18.9	5000	2048	0.000164 0.185	35	5.12 0.58	4 1.82
NT-320	5.4	16.2	1.5	16.0	4000	2048	0.000328 0.370	29	3.50 0.40	6 2.72
NT-330	6.25	18.38	1.2	15.0	4000	2048	0.000438 0.494	36	5.04 0.57	7.3 3.31
NT-345	6.59	19.8	1.3	17.0	3000	2048	0.000668 0.754	50	7.13 0.81	10 4.54

NT Holding Brake Specifications

Motor Frame Size	Volt (DC)	Current (A)	Static Torque lb-in (Nm)	Mechanical Disengagement Time-Brake Released (ms)	Mechanical Engagement Time-Brake Holding (ms)	Added Inertia lb-in-sec ² (kg-cm ²)		
2"	24	0.33	20	2.26	28	14	0.000106	0.12
3"	24	0.65	88.5	10	43	13	0.000968	1.093

Motor Model	NT
AC Supply Voltage	240
Frame	2", 3"
Flange	NEMA
Continuous Torque	Up to 37 lb-in (4.1Nm)
Peak Torque	Up to 65 lb-in (7.3Nm)
Rated Torque/Speed	Up to 37 lb-in (4.1Nm)
Standard Rated Speeds	5000, 4000, 3000 RPM
Brake	Optional
Connectorized	Standard
Inertia	Very Low
Encoder Resolution	2048 lines/rev
Insulation Class	Class F, EN 60034-1, IEC 664-1
Temperature	Thermostat, 155° switch
Ingress Protection	IP65
Approvals	CE, UL



NT Motor Dimensions

English Dimensions		2"			3"	
		NTE-207	NTE-212	NTE-320	NTE-330	NTE-345
A	Length Overall - CONS (Max)	5.55 (141)	6.55 (166.4)	5.218 (132.5)	5.818 (147.8)	7.018 (178.26)
A	Length Overall - CBNS (Max)	6.95 (176.4)	7.95 (201.8)	7.24 (184)	7.84 (199.2)	9.043 (229.7)
B	Flange Square	2.27 (57.66)	2.27 (57.66)	3.42 (86.87)	3.42 (86.87)	3.42 (86.87)
C	Flange Thickness	0.3 (7.49)	0.3 (7.49)	0.3 (7.62)	0.3 (7.62)	0.3 (7.62)
D	Pilot Diameter	1.5 (38.1)	1.5 (38.1)	2.875 (73.03)	2.875 (73.03)	2.875 (73.03)
E	Pilot thickness	0.1 (2.54)	0.1 (2.54)	0.1 (2.54)	0.1 (2.54)	0.1 (2.54)
F	Bolt Hole Diameter	0.205 (5.21)	0.205 (5.21)	0.22 (5.59)	0.22 (5.59)	0.22 (5.59)
G	Bolt Circle Diameter	2.625 (66.68)	2.625 (66.68)	3.875 (98.43)	3.875 (98.43)	3.875 (98.43)
H	Signal Connector Height - CONS (Max)	1.925 (48.89)	1.925 (48.89)	2.45 (62.24)	2.45 (62.24)	2.45 (62.24)
H	Signal Connector Height - CBNS (Max)	1.98 (50.4)	1.98 (50.4)	2.56 (65)	2.56 (65)	2.56 (65)
I	Shaft Length	1.2 (30.7)	1.2 (30.7)	1.2 (30.7)	1.2 (30.7)	1.2 (30.7)
J	Shaft Diameter	0.375 (9.525)	0.375 (9.525)	0.5 (12.7)	0.5 (12.7)	0.5 (12.7)

Shaft key Dimensions		2"			3"	
K	Keyway Length (Min)	0.7 (17.78)	0.7 (17.78)	0.84 (21.34)	0.84 (21.34)	0.84 (21.34)
L	Keyway Depth	0.079 (2.007)	0.079 (2.007)	0.077 (1.96)	0.077 (1.96)	0.077 (1.96)
M	Keyway Width	0.126 (3.2)	0.126 (3.2)	0.127 (3.23)	0.127 (3.23)	0.127 (3.23)

2" NTE Motor

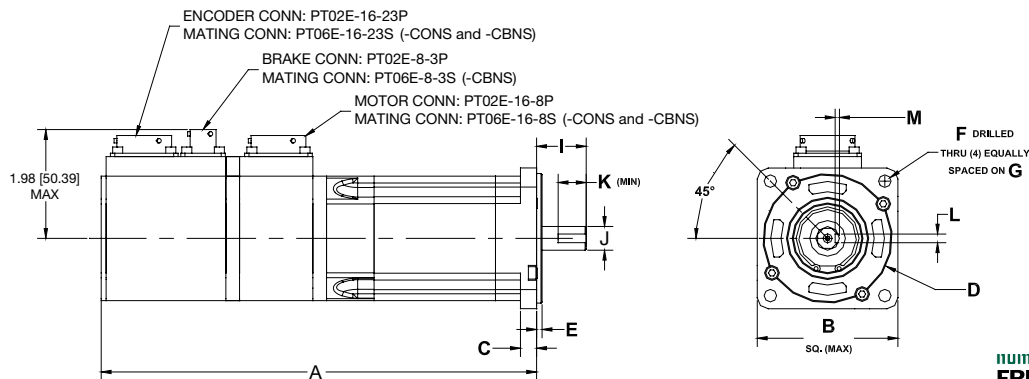

3" NTE Motor

The dimensional information found on these pages is not to be used for design purposes. For complete engineering controlled drawings, please refer to numatics.com.

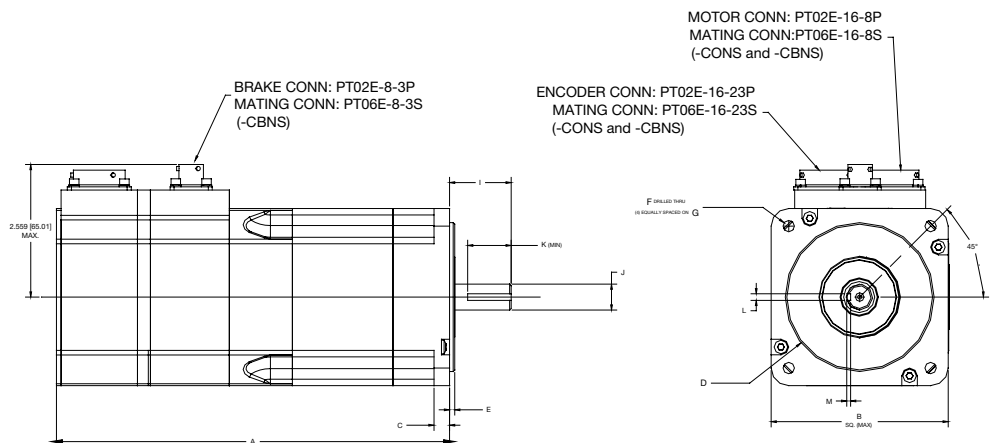



Cables-Accessories

Numatics builds its cables to the highest standards. Drives are engineered so that connections are easily accessible and, in many cases, no wiring is involved, simply plug and play.

Command Cables

CMDX



-003, -005, -015
Command cable; 18 pair; DB44M straight connectors on both ends.

Epsilon

CDRO



-005, -010, -015
Command cable to position controller; 13 pair; 45° angle connector at drive (DB44M); pigtails on other end for screw terminals.

Epsilon, MDS to Position Controller, PLC

Standard Power Cables (NT)

CMDS



-015, -025, -050
16 AWG for 2" and 3" motors, connector on motor end, ferrules on drive end. Fully shielded with IP-65 molded connector.

Epsilon, NT

Standard Feedback Cables

CFCS



-015, -025, -050
Motor feedback cable, connector both ends.

Epsilon, NT

CFOS



-015, -025, -050
Motor feedback cable, connector at motor only.

NT

Standard Brake Cable

CBMS



-015, -025, -050
Motor brake cable, molded standard duty, connector at motor only.

See page 11 for How To Order

Brake Relay

BRM-1 to NT BRM-1



Brake relay module, 24V 1 contact, 6 amp, DIN rail mounting.

Interface Terminals

STI-EIO

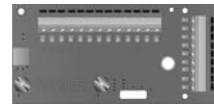

Screw Terminal Interface, breakout board plugs directly into Epsilon drive I/O connector (J3", 13 input and 7 output lines are labeled and LEDs for easy field wiring and troubleshooting.

Epsilon

ECI-44

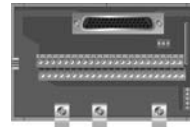

External connection interface terminal strip; provides a convenient field wire screw terminal strip for all connections available on the drive's command connector. Requires a CMDX to connect to the drive. Includes labeled terminals and provisions for DIN rail mounting.

Epsilon

External Shunts/Resistors

ES-20-500

20 Ohm, 0.5kW

Epsilon

ES-20-1K

20 Ohm, 1kW

Epsilon

ES-20-2K

20 Ohm, 2kW

Epsilon

ES-30-1K

30 Ohm, 1kW

Epsilon

ES-30-2K

30 Ohm, 2kW

Epsilon

RSR-2

2kW regeneration shunt regulator, 120-230 VAC, stackable. One RSR-2 with an appropriately sized shunt resistor can increase the regeneration capacity of a drive to 2kW.

Epsilon

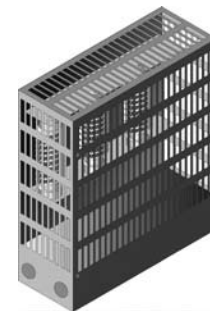



OIT-3165

The OIT-3165 is a low cost operator interface panel that gives users access to many of the parameters in the Epsilon family. The small size of the OIT-3165 allows it to fit into any panel. It features a 24-key keypad with user-definable keys and a slide-in legend. The user-definable keys allow you to configure the operator interface terminal with the exact keys that your application requires and to arrange those keys in any order. The slide-in legend allows you to label the keys with any combination of text, graphics and colors. The unit also features a bright 2 line x 20 character backlit LCD display. The OIT-3165 is CE rated, and is sealed to NEMA 4/12 when panel mounted.

The OIT-3165 communicates via the Epsilon Modbus RTU driver. The OIT-3165 supports bit variables as well as 16-bit and 32-bit integers.

Mechanical Material:

Aluminum enclosure, polyester keypad overlay. Mounting: Panel Weight: 1 pound .45kg

Communication:

One RS-232/RS-422/RS-485 serial port; used for both OIT configuration from a personal computer and for communication with the target device.

Features

- 2 Line x 20 character high contrast display
- 24 user-programmable keys
- Easy to use, Window-based OITware-200 configuration software
- Predefined function key types
- Supports 32 bit Modbus RTU
- Up to 500 screens available
- Simple recipe configuration

Specifications

Power Supply	User supplied 12-30 VDC power supply (2.5W)
Protocols	Modbus RTU
Environmental Protection NEMA	4/12, IP65

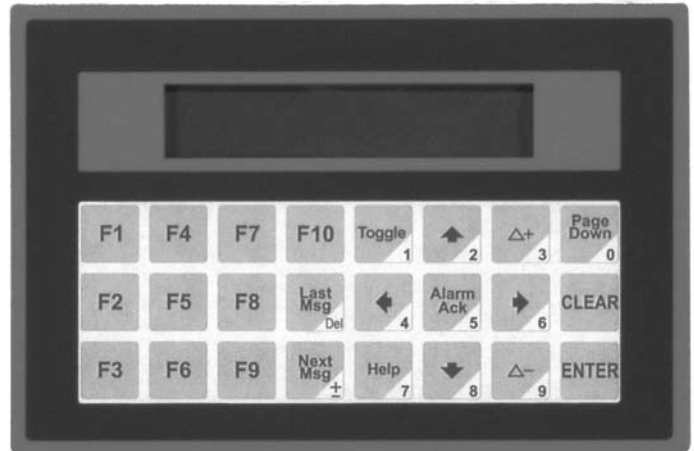

How to order

To order a complete OIT System requires the Interface unit and OIT configuration software models listed below, plus the appropriate interface cabling depending on your application.

OIT3165-A00

Operator Interface Panel 2 line x 20 character LCD display, 24 key keypad

Catalog Number	Height	Width	Depth
OIT-3165	4.0 (101.5)	6.0 (152.4)	1.76 (44.7)

OITware-200

Window configuration software for OIT panel

OIT-EN-485-xxx From OIT to Drive

9pin D-sub male to RJ-45. Connects Epsilon to OIT-3165 (RS485)

OIT-PC-232-xxx Programming

9pin D-sub male to RJ-45. Connects PC to OIT-3165 (RS232), and used for programming the OIT.

D9P-D9P

9pin D-sub male to RJ-45 male adapter to interface the OIT-PC-232 to Epsilon Drive.



Inline Gearboxes

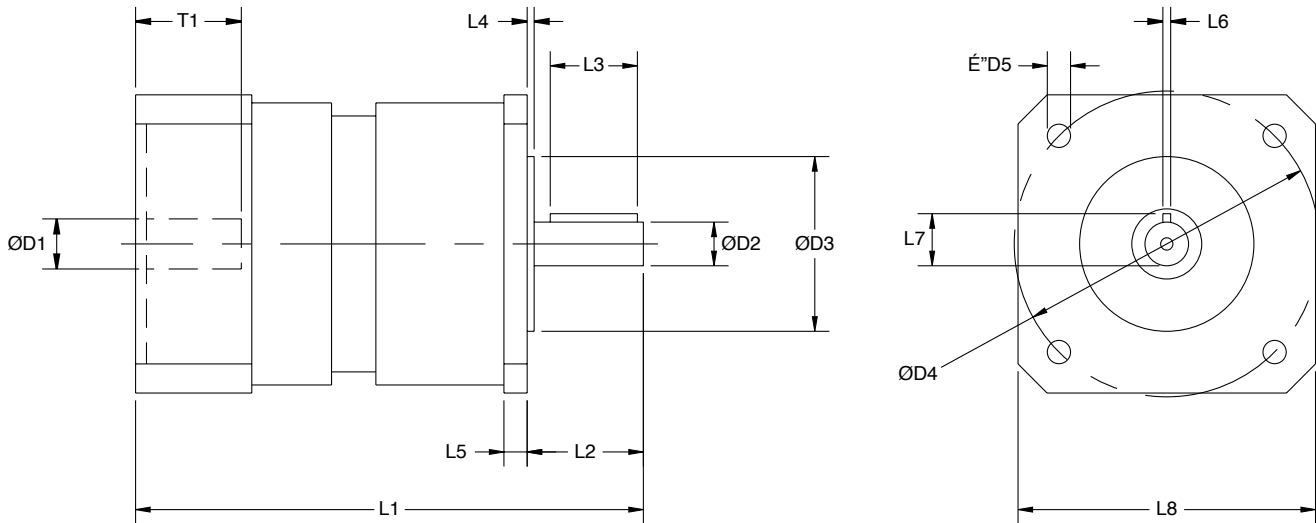

NEMA Series	NEMA 23		NEMA 34		NEMA 42	
	mm	(in)	mm	(in)	mm	(in)
L1 1-STAGE*	111	(4.37)	147	(5.79)	185	(7.28)
L1 2-STAGE*	133	((5.24)	180	(7.09)	225.5	(8.88)
L1 3-STAGE*	155	(6.10)	213	(8.39)	266	(10.47)
L2	25.4	(1.00)	31.8	(1.25)	38.1	(1.50)
L3	19	(0.75)	27	(1.06)	29	(1.14)
L4	1.6	(0.06)	1.7	(0.07)	2.4	(0.09)
L5	5	(0.20)	10	(0.39)	13	(0.51)
L6	-	(-)	3.2	(0.125)	4.8	(0.1875)
L7	-	(-)	14.3	(0.5625)	18.26	(0.7188)
L8	65	(2.56)	90	(3.54)	120	(4.72)
D1max	11	(0.43)	19	(0.75)	24	(0.94)
D2	9.252	(0.375)	12.7	(0.500)	15.875	(0.625)
D3	38.1	(1.500)	73	(2.875)	55.55	(2.185)
D4	66.7	(2.625)	98.4	(3.875)	125.7	(4.95)
D5	5	(0.20)	5.5	(0.22)	7.1	(0.28)
T1*	23	(0.91)	30	(1.18)	40	(1.57)

*Value can vary depending on the motor

How to Order

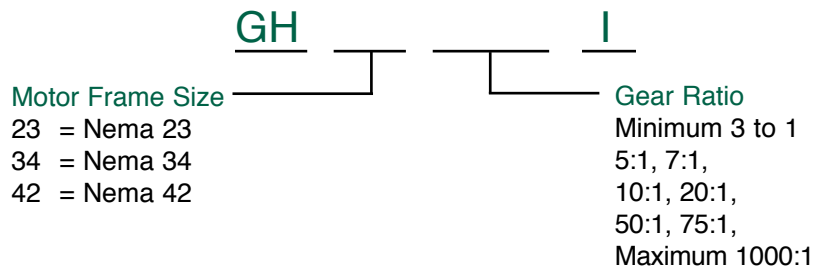



NEMA Series			NEMA 23	NEMA 34	NEMA 42	
Rating	Symbol	Unit	Ratio			
Nominal Output Torque	T2n	Nm (lb-in)	i=3	18 (159)	40 (354)	100 (885)
			i=4,5,7	18 (159)	54 (478)	120 (1062)
			i=10	14 (124)	40 (354)	104 (920)
			i=100,1000	16 (142)	60 (531)	120 (1062)
			i=all other ratios	18 (159)	60 (531)	120 (1062)
Maximum Output Torque	T2n	Nm (lb-in)	18 (159)	60 (531)	120 (1062)	
Max. Input Speed	n1n	RPM	6000	5000	5000	
Nominal Input Speed	n1n	RPM	3000	3000	3000	
Standard Output Backlash	j	arcmin	1- stage	< 10	< 10	<10
			2-stage	< 15	< 15	< 15
			3- stage	< 20	< 20	<20
Weight	m	kg (lb)	1- stage	1 (2.2)	2.3 (5)	5.8 (13)
			2- stage	1.3 (2.9)	3.1 (7)	7.9 (17)
			3- stage	1.6 (3.5)	3.9 (9)	10 (22)
Mass Moment of Inertia	j _i	kgcm ² (lb-in ²)	i=3	0.176 (0.06)	0.542 (0.18)	2.54 (0.9)
			i=4	0.159 (0.05)	0.424 (0.14)	1.76 (0.6)
			i=5	0.15 (0.05)	0.379 (0.13)	1.48 (0.5)
			i=7,10	0.138 (0.05)	0.332 (0.11)	1.14 (0.4)
			i=12-35	0.156 (0.05)	0.407 (0.14)	1.51 (0.5)
			i=40-1000	0.136 (0.05)	0.327 (0.11)	1.07 (0.4)

Ratios Available 1-stage: 3/4/5/7/10 2-stage: 12/16/20/25/35/40/50/70/100 3-stage: 120/160/200/250/350/490/700/1000
Efficiency at Maximum Loading 1-stage:90% 2-stage: 85% 3-stage: 80%
Service Life >20,000 hours
Operating Temperature Range -20°C to 90°C



Shaft Coupler Ordering

Product	NEMA 23*	NEMA 34**	NEMA 42
BSG106	SCP10623*	SCP10634	—
BSG150	SCP15023*	SCP15034	—
BSG200	—	SCP20034	SCP20042
BDU50	SCP5023*	SCP5034	—
BDU55	SCP5523	SCP5534	—
BDU75	—	SCP7534	SCP7542
BDU90	—	SCP9034	SCP9042
BDU100	—	SCP10034	SCP10042

*NOTE: Add suffix "A" for all NEMA 23, 3 Stack Motors
Example: SCP5023A

** Add suffix "B" for LTS 342 and 344 motors

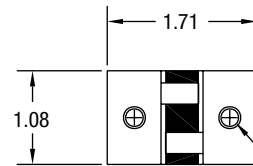

All 23 frame BDU's and BSG's, BSG 106 and BSG 150 with 34 frame motor

1/4-20 SET SCREW
2 PLACES

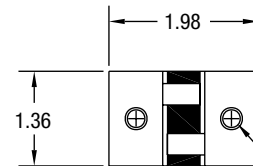

All 34 and 42 frame BDU's, BSG 20034 and BSG 20042

1/4-20 SET SCREW
2 PLACES

Accessory Items

RS232 Programming Cable for NSMC Controller and NSDP6C Motor Drive Controller

Part Number PC232 10 foot length

RS232 Programming Cable for SAC300-8A

Part Number PCS232 5 foot length

RS232 to RS485 Converter

Part Number C232-485

motors

XV Series

Metric Servo Motors

Available July 2006



numatics

www.numatics.com



XV Series23
Specifications23



Specifications

Drive Model	Motor Model	Combination Specific				Motor Data					
		Cont. Stall Torque (lb-in/Nm)	Peak Stall Torque (lb-in/Nm)	Rated Torque at Rated Speed (lb-in/Nm)@RPM	Rated Power (HP/kW)	Max Operating Speed	Encoder Resolution (Lines Per Rev)	Inertia (lb-in-sec ²)/(kg-cm ²)	Motor Ke (Vrms/krpm)	Motor Kt (lb-in/Arms)/(Nm/Arms)	Motor Weight (lb/kg)
*-202	XV-606	5.7/.64	12.6/1.42	5.7/.64	.27/.202	5000	2048	0.000161/0.182	29.2	3.717/0.42	2.4/1.11
*-203	XV-6011	11.24/1.27	23.3/2.64	11.24/1.27	.54/.399	5000	2048	0.000284/0.321	29.5	4.071/0.46	3.5/1.63
*-205	XV-8022	22.6/2.55	46.8/5.29	22.6/2.55	1.08/.802	5000	2048	0.001335/1.509	35.6	5.0445/0.57	6.9/3.15
*-205	XV-13051	50.7/5.73	122.2/13.8	50.7/5.73	.8/.6	2000	2048	0.010611/11.99	85.8	12.567/1.42	15.8/7.2

* = Eb, Ei or Ei-DN

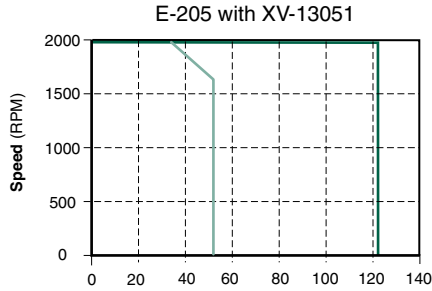
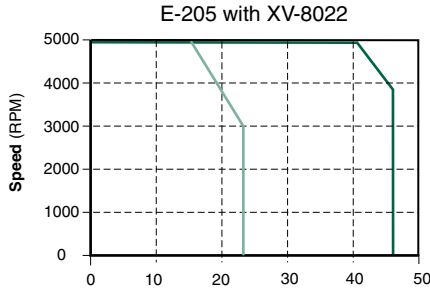
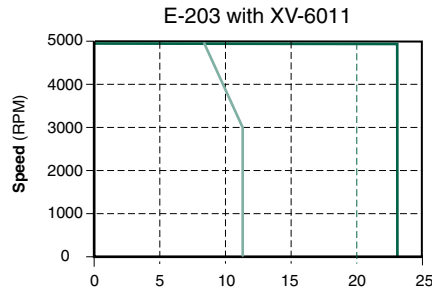
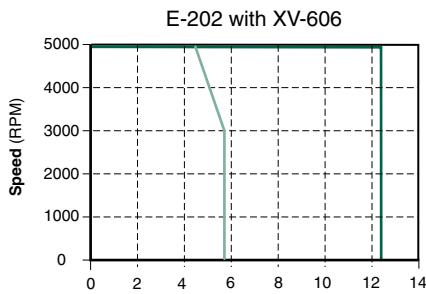

Legend

- Continuous (lb-in)
- Peak (lb-in)

NUMATICS

*World Class Supplier
of Pneumatic Components*

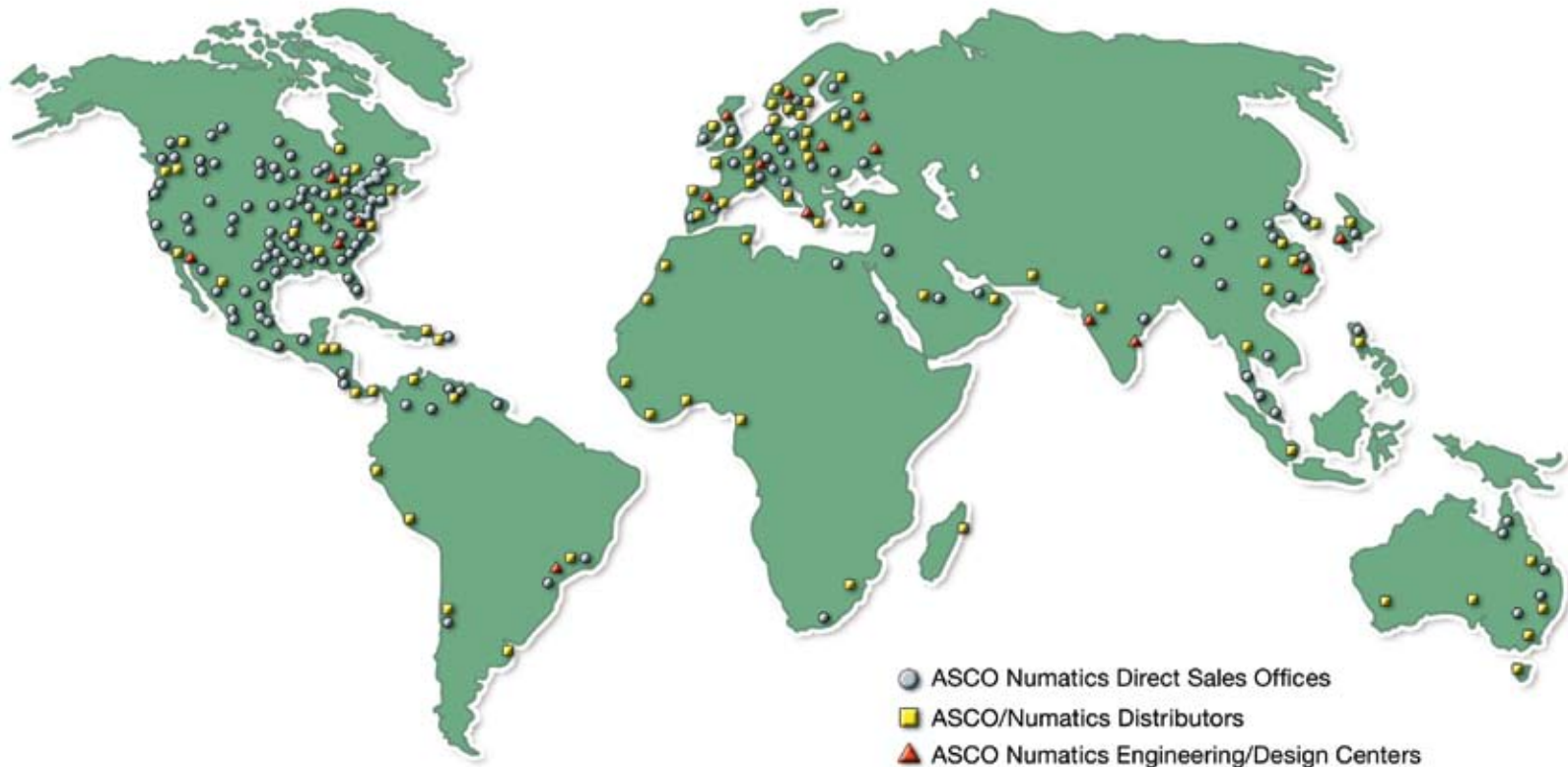

WORLD HEADQUARTERS

USA

Numatics, Incorporated

46280 Dylan Drive
Novi, Michigan 48377

P: 1-888-Numatics
1-888-686-2842

Canada

Numatics, Ltd

P: 519-452-1777

Mexico

Numatics de Mexico S.A. de C.V.

P: 52-222-284-6176

For a comprehensive listing of all Numatics production and distribution facilities worldwide, visit:

www.numatics.com