

**INTRODUCTION:**

Adam Tech's RFC series RF connectors are a comprehensive assortment of Radio Frequency signal connectors in standard, miniature, sub-miniature, micro miniature and surface mount styles. Included are BNC, TNC, FME, FMA, SMA, SMB, N, F, PAL, UHF, Mini-UHF, MCX, MMCX, MHF, W.FL & 1.6/5.6 coupling versions. Each has a standard industry interface. Most are ideal for applications where size and weight are important in densely populated applications. All afford excellent RF characteristics

**FEATURES:**

Bodies available with gold or nickel plating  
 Insulators available in Teflon, Delrin, and Polypropylene  
 Standard availability of 50 or 75 ohms impedance  
 Through hole and SMT types for printed circuit board versions  
 Male and female types available in bulkhead and cable mount versions

**MATING CONNECTORS:**

Adam Tech RF series connectors and all industry Standard RF connectors

**SPECIFICATIONS:**

**Material:**

Housing: Brass, Nickel plated  
 Zinc diecast, Nickel plated  
 Standard Insulators: Delrin, Polypropylene or Teflon  
 Optional Hi-Temp Insulator: Teflon  
 Contacts: Beryllium copper, Gold plated

**Electrical:**

Operating voltage: 150V AC max.  
 Contact resistance: 5 mΩ max. initial  
 Impedance: 50 or 75 ohms  
 Insulation resistance: 5000 M min.  
 Dielectric withstanding voltage: 1000V AC for 1 minute  
 VSWR: 1.2 max  
 Frequency range: 0 – 6 GHZ

**Mechanical:**

Engagement force: 4.5 lbs max  
 Disengagement force: 2 lbs min  
 Cable retention: equal to breaking strength of cable employed  
 Durability: 500 cycles

**Temperature Rating:**

Operating temperature: -20°C to +85°C  
 Soldering process temperature:  
 Standard insulator: 235°C  
 Hi-Temp insulator: 260°C

**PACKAGING:**

Anti-ESD plastic trays or bags

**APPROVALS AND CERTIFICATIONS:**

UL Recognized & CSA Certified,  
 File no. E224053



**ORDERING INFORMATION**

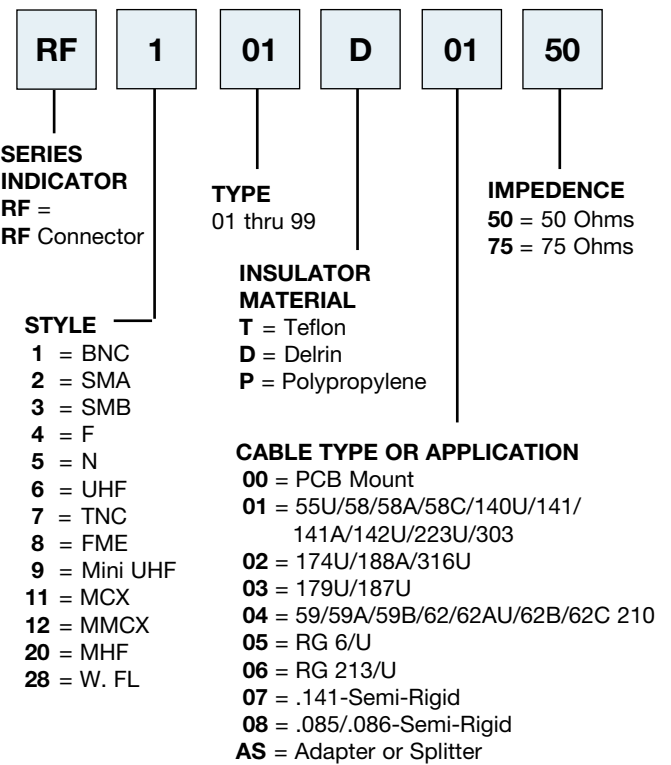

**OPTIONS:**

Add as suffix to basic part no.  
**HT** = Hi-Temp insulator for hi-temp soldering processes up to 260°C  
**G** = Gold plated body and contact

**RF1 TYPE 01**  
BNC RIGHT ANGLE FEMALE PCB MOUNT

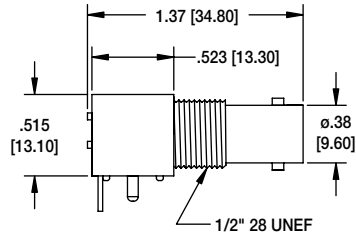
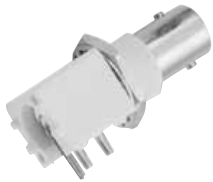

RF1-01-P-00-50

**RF1 TYPE 01V**  
BNC STRAIGHT FEMALE PCB MOUNT

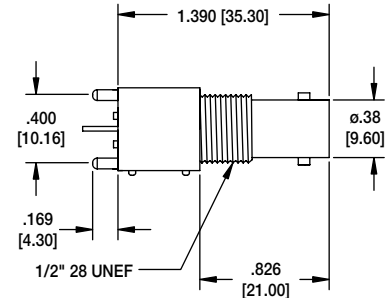
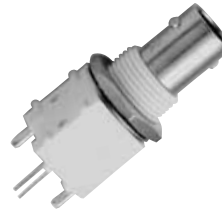

RF1-01V-P-00-75

**RF1 TYPE 01A**  
BNC HIGH PROFILE RIGHT ANGLE FEMALE PCB MOUNT

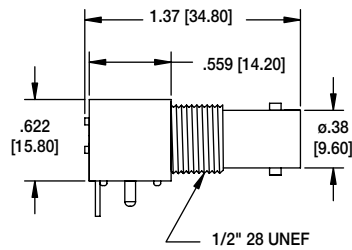
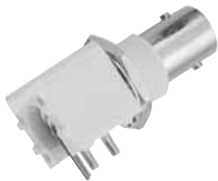

RF1-01A-P-00-50

**RF1 TYPE 03**  
BNC MALE CRIMP

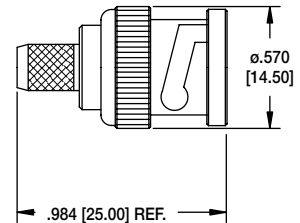

RF1-03-D-05-75

**RF1 TYPE 04**  
BNC FEMALE BULKHEAD CRIMP

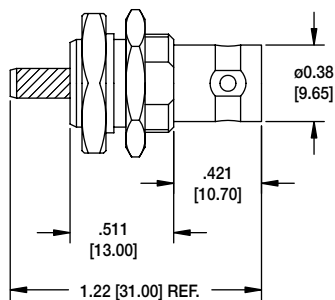
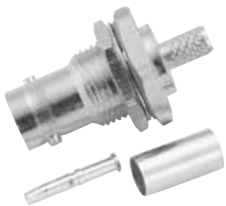

RF1-04-T-01-75

**RF1 TYPE 05**  
BNC MALE TO BNC DOUBLE FEMALE

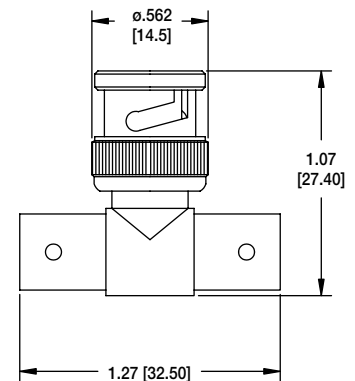

RF1-05-D-AS-75

**RF1 TYPE 06**  
BNC MALE "Y" ADAPTER

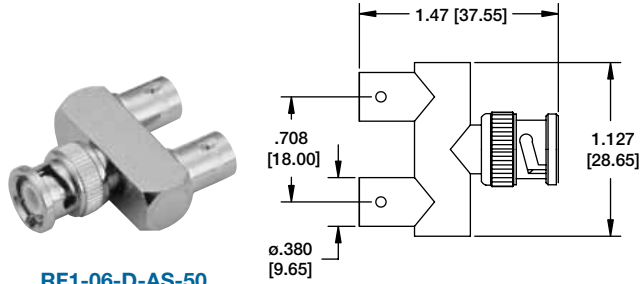

RF1-06-D-AS-50

**RF1 TYPE 07**  
BNC FEMALE PC BOARD MOUNT

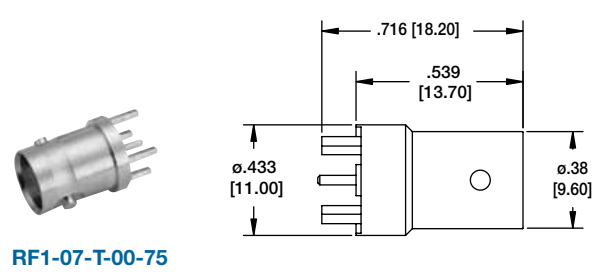

RF1-07-T-00-75

**RF2 TYPE 01**  
SMA RIGHT ANGLE MALE CRIMP TYPE

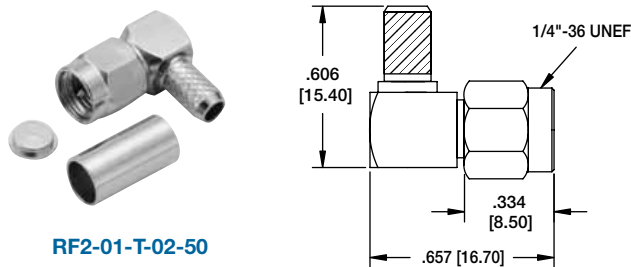

RF2-01-T-02-50

**RF2 TYPE 02**  
SMA MALE CRIMP TYPE

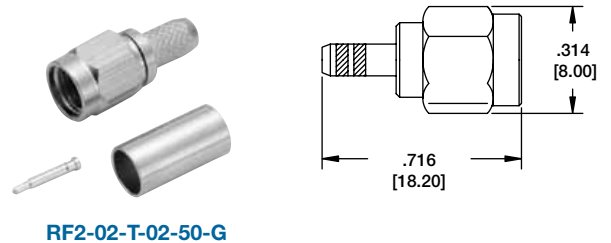

RF2-02-T-02-50-G

**RF2 TYPE 03**  
SMA RIGHT ANGLE FEMALE PC BOARD MOUNT

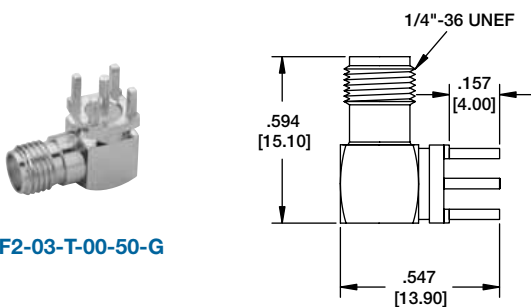

RF2-03-T-00-50-G

**RF2 TYPE 04**  
SMA FEMALE PC BOARD MOUNT

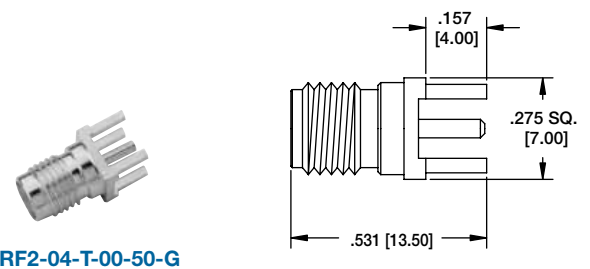

RF2-04-T-00-50-G

**RF2 TYPE 05**  
SMA FEMALE CHASSIS CRIMP

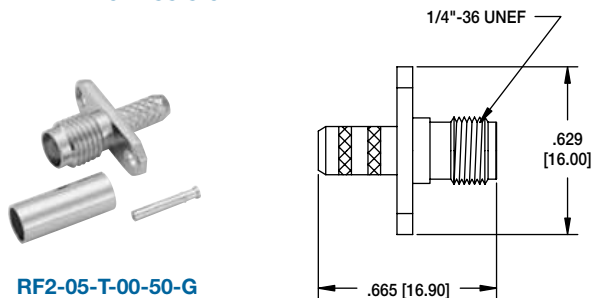

RF2-05-T-00-50-G

**RF2 TYPE 06**  
SMA FEMALE BULKHEAD CRIMP

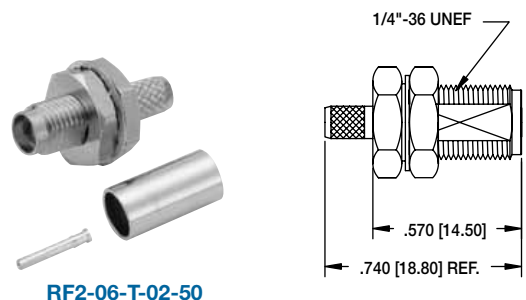

RF2-06-T-02-50

**RF2 TYPE 07**  
**SMA DOUBLE FEMALE ADAPTOR**



**RF2-07-T-AS-50**

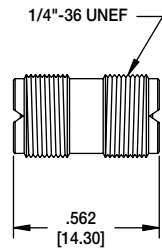

**RF3 TYPE 01**  
**SMB MALE CRIMP**



**RF3-01-T-01-50-G**

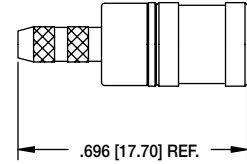

**RF3 TYPE 02**  
**SMB FEMALE CRIMP**

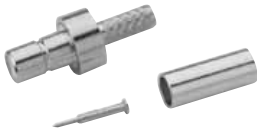

**RF3-02-T-01-50-G**

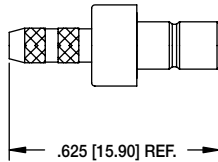

**RF3 TYPE 03**  
**SMB MALE RIGHT ANGLE CRIMP**



**RF3-03-T-03-75-G**

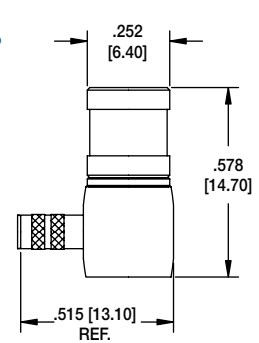

**RF3 TYPE 04**  
**SMB RIGHT ANGLE MALE PCB MOUNT**



**RF3-04-T-00-50-G**

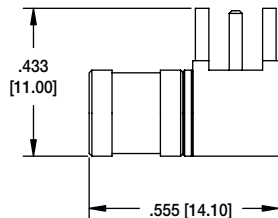

**RF3 TYPE 05**  
**SMB FEMALE PCB MOUNT**



**RF3-05-T-00-50-G**

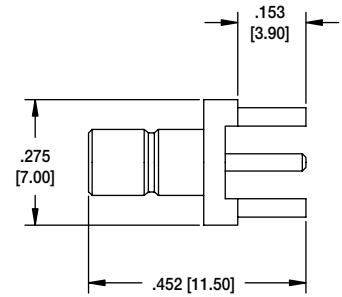

**RF3 TYPE 06**  
**SMB RIGHT ANGLE FEMALE PCB MOUNT**



**RF3-06-T-00-50-G**

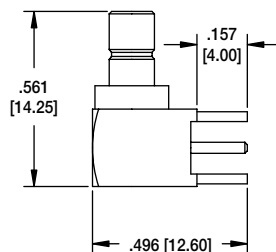

**RF4 TYPE 01**  
**F FEMALE RIGHT ANGLE PCB MOUNT**



**RF4-01-T-00-75**

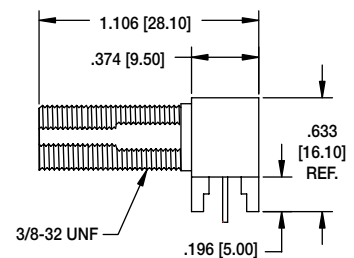

**RF4 TYPE 02**  
F MALE TO MALE

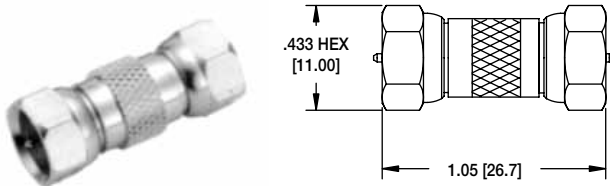

RF4-02-T-AS-75

**RF5 TYPE 01**  
N MALE CRIMP TYPE

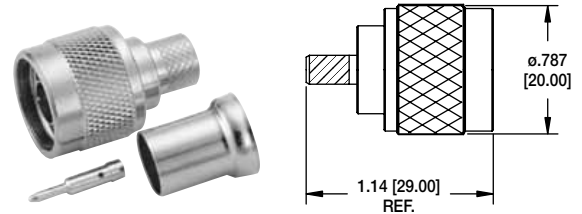

RF5-01-D-01-50

**RF5 TYPE 02**  
N FEMALE PANEL RECEPTACLE

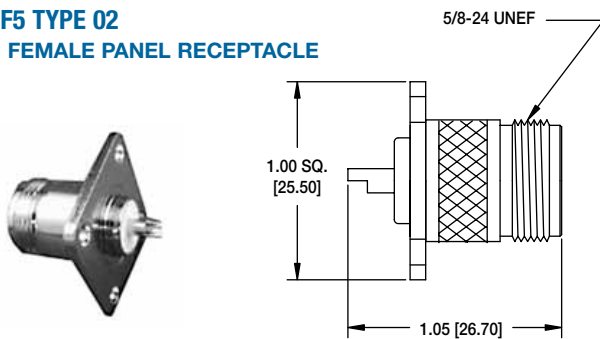

RF5-02-D-01-50

**RF6 TYPE 01**  
UHF DOUBLE FEMALE

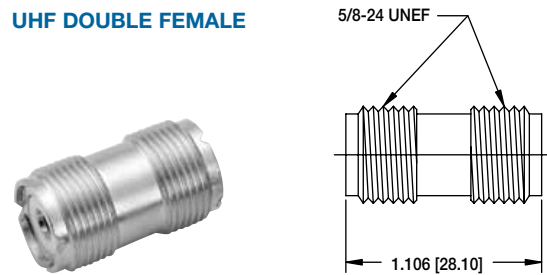

RF6-01-D-AS-50

**RF7 TYPE 01**  
TNC MALE CRIMP

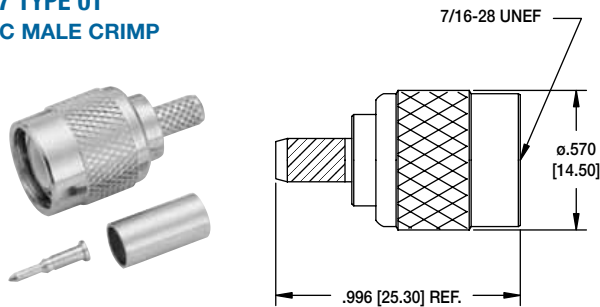

RF7-01-D-02-50

**RF8 TYPE 01**  
FME MALE CRIMP

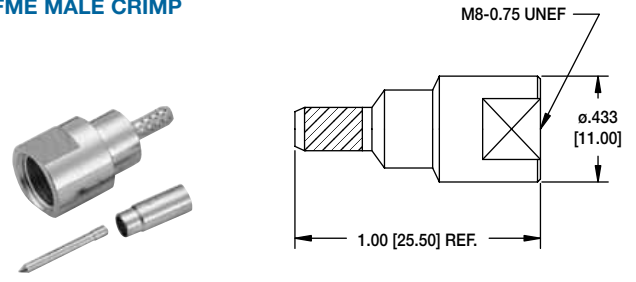

RF8-01-T-01-50-G

**RF8 TYPE 02**  
FME MALE TO BNC MALE

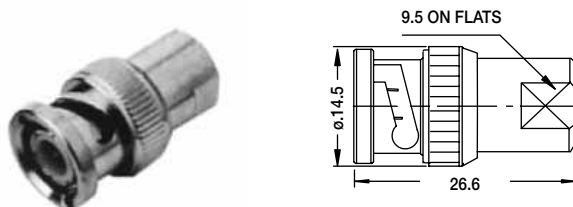





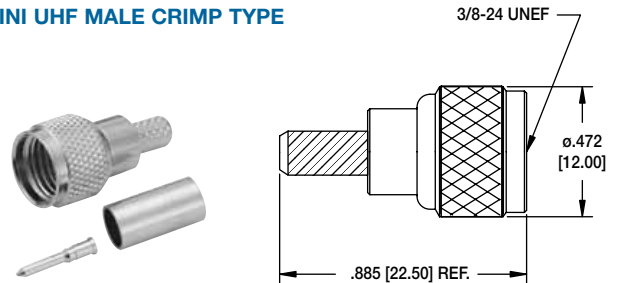



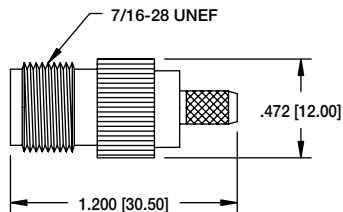

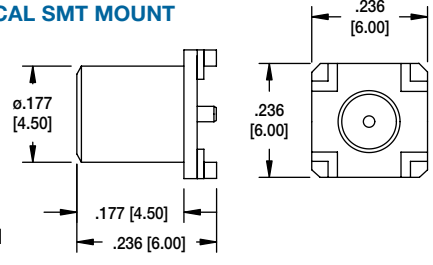

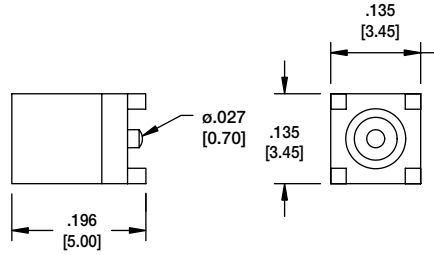
RF8-02-T-AS-50

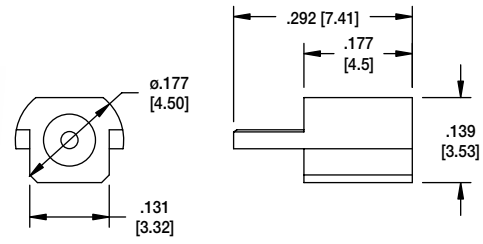
**RF9 TYPE 01**  
MINI UHF MALE CRIMP TYPE

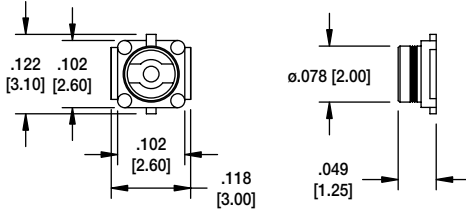
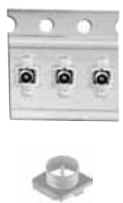
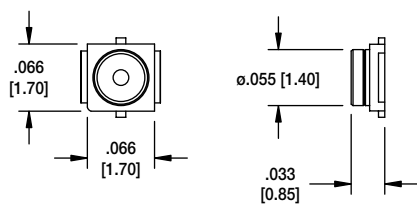

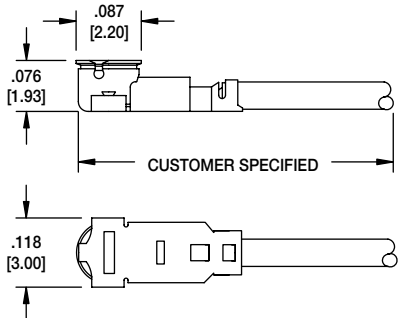
RF7-01-D-02-50

<p><b>RF7 TYPE 08</b> <b>TNC FEMALE CRIMP</b></p>  <p><b>RF7-08-T-02-50-G</b></p> 	<p><b>RF11 TYPE 01</b> <b>MCX FEMALE VERTICAL SMT MOUNT</b></p>  <p><b>RF11-01-T-00-50-G</b> Enlarged to show detail</p> 
<p><b>RF12 TYPE 04</b> <b>MMCX MALE VERTICAL PCB MOUNT</b></p>  <p><b>RF12-04-T-00-50-G</b> Enlarged to show detail</p> 	<p><b>RF12 TYPE 05</b> <b>MMCX PCB MOUNT</b></p>  <p><b>RF12-05-T-00-50-G</b></p> 
<p><b>RF20 TYPE 01</b> <b>MHF SURFACE MOUNT</b></p>  <p><b>RF20-01-p-00-50-G</b> Enlarged to show detail</p> 	<p><b>RF28 TYPE 01</b> <b>W.FL SURFACE MOUNT</b></p>  <p><b>RF28-01-T-00-50-G</b> Enlarged to show detail</p> 
<p><b>RF20 TYPE 01 CABLE ASSEMBLY</b> <b>MATES WITH MHF SMT CONNECTOR</b></p>  <p><b>CA# 6994-XX</b></p> 	<p><b>RF28 TYPE 01 CABLE ASSEMBLY</b> <b>MATES W.FL SMT CONNECTOR</b></p>  <p><b>CA# 6993-XX</b></p> 