



Mini Encapsulated

-PC Board mounting or
-with screw terminals

- Shipped Within 6 Days
- One Year Warranty

SWITCHING REGULATED

DC output (accepts either AC or DC input)



Don't forget these facts about Acopian....

1. We ship within 3 Days (see our 3 Day Shipping Promise below).
2. Acopian power supplies last a *very long time*.
3. The Voltage Finder is the quickest way to find a power supply with the specs you need.
4. The Online System builder (www.acopian.com/SystemBuilder) is a convenient way to get your own custom Power System (and they ship within 9 Days).
5. You always talk to a real person when you call Acopian.
6. You can order your Acopian power supplies factory direct.
7. You can order your Acopian power supplies online.
8. All Acopian products are made in the USA.



Acopian Technical Company • Easton, PA
 1-800-523-9478 • www.acopian.com
 Order Factory Direct   
 Made in USA 





single output

Mini Encapsulated - PC Board mounting or - with screw terminals

SWITCHING REGULATED
DC output (accepts either AC or DC input)



- Shipped Within 6 Days
- One Year Warranty

These versatile power supplies mount in a surface area of only 3.5" x 2.5", and are available in a choice of mounting styles. They have a high efficiency and may be operated through a wide temperature range.

STANDARD FEATURES

- Compact, lightweight, fully encapsulated
- Short circuit and overload protected
- No heat sinking or forced air required
- Input/output isolation
- Extensive EMI filtering and shielding

SPECIFICATIONS

Input Voltage: 85-130 VAC, 47-420 Hz, single phase, or 120-180 Vdc. DC input may be connected without regard to polarity.

Output Voltage Setting: Output is factory preset to within $\pm 2\%$ (5 to 9 volt models) or $\pm 1\%$ (10 to 48 volt models) of the nominal output voltage.

T/C terminal (Output Voltage Trim Adjustment):The T/C terminal can be used to trim the output more precisely to the nominal voltage rating by connecting an external resistor from the T/C terminal to either the + or - terminal.

Polarity: Output is floating. Either positive or negative terminal may be grounded.

Regulation:

Load: $\pm 0.05\%$ (5 and 6 volt "WL" models, $\pm 0.1\%$)

Line: $\pm 0.05\%$

Ambient Operating Temperature: -10 to $+71^\circ\text{C}$.

No derating required through $+50^\circ\text{C}$.

Storage Temperature: -40 to $+85^\circ\text{C}$.

Temperature Coefficient: $\pm 0.02\%/^\circ\text{C}$ (Typical).

Humidity: Maximum of 90% relative, non-condensing.

Overload/Short Circuit Protection: Power foldback with automatic recovery.

Isolation:

Input to output: 1400 Vdc

Input to ground: 1400 Vdc

Output to ground: 400 Vdc

A common-mode input filter reduces conducted noise, and the shielded case minimizes radiated energy. Their outputs may be used in either polarity, and may be precisely trimmed.

Efficiency: 76% (Typical).

Switching Frequency: 225 kHz (Typical).

Transient Response: Returns to within $\pm 1\%$ of output setting within 300 μs . Maximum of $\pm 3\%$ output excursion following a load step change from 50% to 100% of rating.

Holdup Time: 33 mS (Typical, at nominal input voltage with full load).

Mounting: Models for PC Board mounting may also be mounted in the socket shown below. For models with screw terminals, when wall-mounting or DIN rail mounting is desired, use accessory Mounting Kits on page 77.

ACCESSORY SOCKET

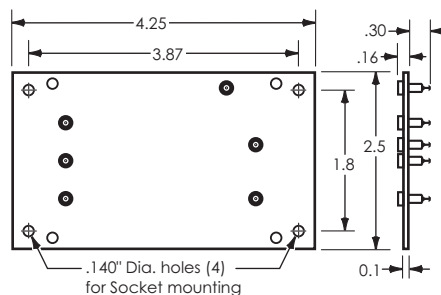

Accepts power supplies in case sizes ELW-13 and ELW-20. Sturdy phenolic base with gold plated teflon-insulated contacts.

Model ELW-1\$20



FOR PC BOARD MOUNTING

Nominal Output Voltage	Output Current Amps. at		Ripple mV (@ 25 MHz BW)		(\$) Price	Model	Case Size
	50°C	71°C	RMS	P-P			
5	6.00	3.60	10	50	187	5WL600	ELW-13
5	10.00	6.00	10	50	212	5WL1000	ELW-20
6	5.00	3.00	10	50	187	6WL500	ELW-13
6	8.30	4.95	10	50	212	6WL830	ELW-20
7	4.20	2.50	15	100	187	7WL420	ELW-13
7	7.10	4.26	15	100	212	7WL710	ELW-20
8	3.70	2.20	15	100	187	8WL370	ELW-13
8	6.20	3.70	15	100	212	8WL620	ELW-20
9	3.30	2.00	15	100	187	9WL330	ELW-13
9	5.50	3.30	15	100	212	9WL550	ELW-20
10	3.00	1.80	15	100	187	10WL300	ELW-13
10	5.00	3.00	15	100	212	10WL500	ELW-20
11	2.70	1.60	15	100	187	11WL270	ELW-13
11	4.50	2.70	15	100	212	11WL450	ELW-20
12	2.50	1.50	15	100	187	12WL250	ELW-13
12	4.10	2.45	15	100	212	12WL410	ELW-20
13	2.30	1.38	15	100	187	13WL230	ELW-13
13	3.80	2.25	15	100	212	13WL380	ELW-20
14	2.10	1.25	15	100	187	14WL210	ELW-13
14	3.50	2.10	15	100	212	14WL350	ELW-20
15	2.00	1.20	15	100	187	15WL200	ELW-13
15	3.30	1.95	15	100	212	15WL330	ELW-20
16	1.85	1.10	15	100	187	16WL185	ELW-13
16	3.10	1.85	15	100	212	16WL310	ELW-20
17	1.75	1.05	15	100	187	17WL175	ELW-13
17	2.90	1.75	15	100	212	17WL290	ELW-20
18	1.65	1.00	15	100	187	18WL165	ELW-13
18	2.75	1.65	15	100	212	18WL275	ELW-20
19	1.55	.93	15	100	187	19WL155	ELW-13
19	2.60	1.55	15	100	212	19WL260	ELW-20
20	1.50	.90	15	100	187	20WL150	ELW-13
20	2.50	1.50	15	100	212	20WL250	ELW-20
21	1.40	.84	15	100	187	21WL140	ELW-13
21	2.35	1.40	15	100	212	21WL235	ELW-20
22	1.35	.80	15	100	187	22WL135	ELW-13
22	2.25	1.35	15	100	212	22WL225	ELW-20
23	1.30	.78	15	100	187	23WL130	ELW-13
23	2.15	1.30	15	100	212	23WL215	ELW-20
24	1.25	.75	15	100	187	24WL125	ELW-13
24	2.10	1.25	15	100	212	24WL210	ELW-20
25	1.20	.72	15	100	187	25WL120	ELW-13
25	2.00	1.20	15	100	212	25WL200	ELW-20
26	1.15	.70	15	100	187	26WL115	ELW-13
26	1.90	1.15	15	100	212	26WL190	ELW-20
27	1.10	.66	15	100	187	27WL110	ELW-13
27	1.85	1.10	15	100	212	27WL185	ELW-20
28	1.05	.63	15	100	187	28WL105	ELW-13
28	1.75	1.05	15	100	212	28WL175	ELW-20
30	1.00	.60	25	150	187	30WL100	ELW-13
30	1.65	1.00	25	150	212	30WL165	ELW-20
36	.85	.50	25	150	187	36WL85	ELW-13
36	1.35	.80	25	150	212	36WL135	ELW-20
40	.75	.45	25	150	187	40WL75	ELW-13
40	1.25	.75	25	150	212	40WL125	ELW-20
45	.65	.40	25	150	187	45WL65	ELW-13
45	1.10	.65	25	150	212	45WL110	ELW-20
48	.65	.40	25	150	187	48WL65	ELW-13
48	1.05	.60	25	150	212	48WL105	ELW-20

WITH SCREW TERMINALS

Nominal Output Voltage	Output Current Amps. at		Ripple mV (@ 25 MHz BW)		(\$) Price	Model	Case Size
	50°C	71°C	RMS	P-P			
5	6.00	3.60	10	50	192	5WB600	EBW-13
5	10.00	6.00	10	50	219	5WB1000	EBW-20
6	5.00	3.00	10	50	192	6WB500	EBW-13
6	8.30	4.95	10	50	219	6WB830	EBW-20
7	4.20	2.50	15	100	192	7WB420	EBW-13
7	7.10	4.26	15	100	219	7WB710	EBW-20
8	3.70	2.20	15	100	192	8WB370	EBW-13
8	6.20	3.70	15	100	219	8WB620	EBW-20
9	3.30	2.00	15	100	192	9WB330	EBW-13
9	5.50	3.30	15	100	219	9WB550	EBW-20
10	3.00	1.80	15	100	192	10WB300	EBW-13
10	5.00	3.00	15	100	219	10WB500	EBW-20
11	2.70	1.60	15	100	192	11WB270	EBW-13
11	4.50	2.70	15	100	219	11WB450	EBW-20
12	2.50	1.50	15	100	192	12WB250	EBW-13
12	4.10	2.45	15	100	219	12WB410	EBW-20
13	2.30	1.38	15	100	192	13WB230	EBW-13
13	3.80	2.25	15	100	219	13WB380	EBW-20
14	2.10	1.25	15	100	192	14WB210	EBW-13
14	3.50	2.10	15	100	219	14WB350	EBW-20
15	2.00	1.20	15	100	192	15WB200	EBW-13
15	3.30	1.95	15	100	219	15WB330	EBW-20
16	1.85	1.10	15	100	192	16WB185	EBW-13
16	3.10	1.85	15	100	219	16WB310	EBW-20
17	1.75	1.05	15	100	192	17WB175	EBW-13
17	2.90	1.75	15	100	219	17WB290	EBW-20
18	1.65	1.00	15	100	192	18WB165	EBW-13
18	2.75	1.65	15	100	219	18WB275	EBW-20
19	1.55	.93	15	100	192	19WB155	EBW-13
19	2.60	1.55	15	100	219	19WB260	EBW-20
20	1.50	.90	15	100	192	20WB150	EBW-13
20	2.50	1.50	15	100	219	20WB250	EBW-20
21	1.40	.84	15	100	192	21WB140	EBW-13
21	2.35	1.40	15	100	219	21WB235	EBW-20
22	1.35	.80	15	100	192	22WB135	EBW-13
22	2.25	1.35	15	100	219	22WB225	EBW-20
23	1.30	.78	15	100	192	23WB130	EBW-13
23	2.15	1.30	15	100	219	23WB215	EBW-20
24	1.25	.75	15	100	192	24WB125	EBW-13
24	2.10	1.25	15	100	219	24WB210	EBW-20
25	1.20	.72	15	100	192	25WB120	EBW-13
25	2.00	1.20	15	100	219	25WB200	EBW-20
26	1.15	.70	15	100	192	26WB115	EBW-13
26	1.90	1.15	15	100	219	26WB190	EBW-20
27	1.10	.66	15	100	192	27WB110	EBW-13
27	1.85	1.10	15	100	219	27WB185	EBW-20
28	1.05	.63	15	100	192	28WB105	EBW-13
28	1.75	1.05	15	100	219	28WB175	EBW-20
30	1.00	.60	25	150	192	30WB100	EBW-13
30	1.65	1.00	25	150	219	30WB165	EBW-20
36	.85	.50	25	150	192	36WB85	EBW-13
36	1.35	.80	25	150	219	36WB135	EBW-20
40	.75	.45	25	150	192	40WB75	EBW-13
40	1.25	.75	25	150	219	40WB125	EBW-20
45	.65	.40	25	150	192	45WB65	EBW-13
45	1.10	.65	25	150	219	45WB110	EBW-20
48	.65	.40	25	150	192	48WB65	EBW-13
48	1.05	.60	25	150	219	48WB105	EBW-20

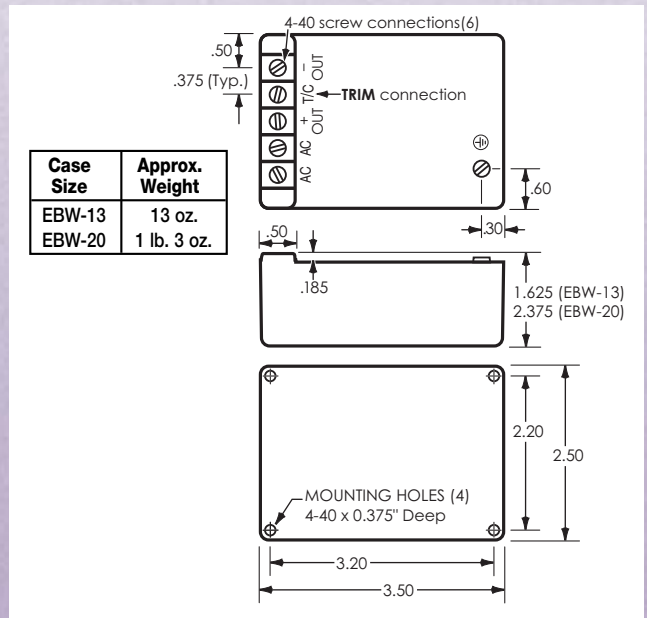
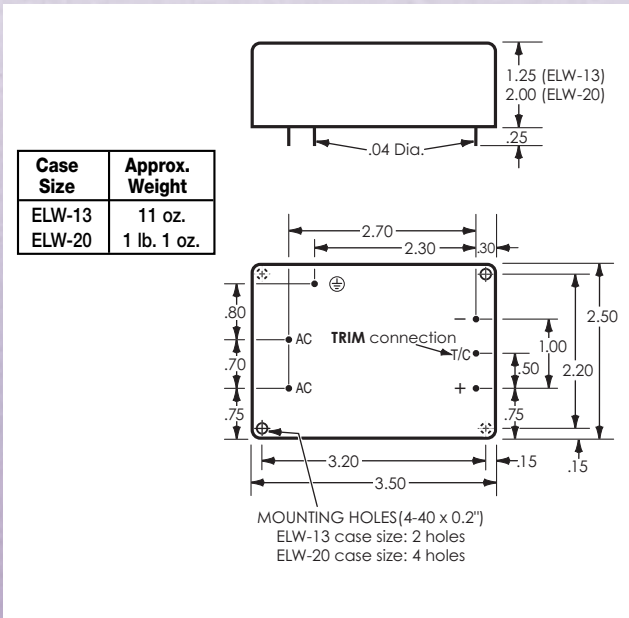

ACCESSORY MOUNTING KITS For use with 'Mini Encapsulated - with Screw Terminals' power supplies.

FOR WALL MOUNTING

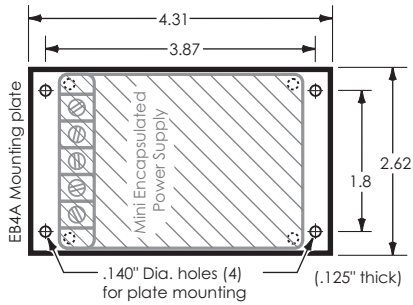

Use Mounting Kit EB4A to mount from the power supply side of the mounting surface, necessary when the other side of the mounting surface is inaccessible. This kit consists of an aluminum plate and four screws for attaching it to the power supply, effectively adding mounting flanges to any Mini Encapsulated power supply with screw terminals or any Mini DC-DC Converter with screw terminals.

Model EB4A \$ 10

FOR DIN RAIL MOUNTING

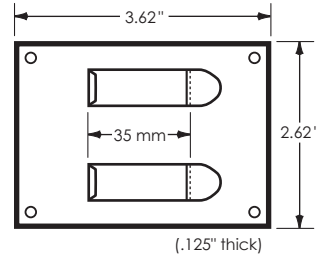

Mounting Kit EB35DIN consists of an aluminum plate, with two DIN clips attached to it, and four screws for attaching the plate to the bottom of any Mini Encapsulated power supply with screw terminals or any Mini DC-DC Converter with screw terminals. The power supply can then be snapped onto a 35mm 'top hat' type of DIN rail.

Model EB35DIN \$15

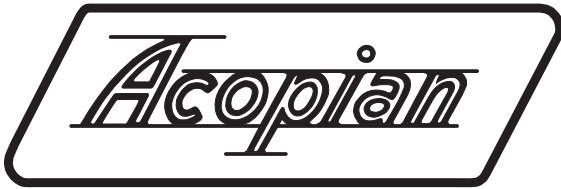

About Acopian's 3 Day Shipment Guarantee:

In 1964, Acopian initiated its "3 Day Shipping Guarantee." Since then our product offerings have expanded to include many more lines of power supplies that ship within 3 Days as well as others that ship within 6 or 9 Days. These guarantees apply to every model in the Acopian catalog.

Our unique 3-day shipping guarantee has prompted many questions. Below are some of those most often asked:

What does Acopian's 3-day shipping promise mean?

It means that power modules listed in this catalog are shipped within 3 days after we receive your order. High Voltage, Redundant, Rack Mounting, Systems and certain Switching power supplies are shipped within 9 days.

Has Acopian ever failed to meet this promise?

Never.

Do options affect shipping time?

The 230 volt input option and moisture/fungus-proofing option require two additional days. All other options do not affect shipping time.

Is the 3-day promise affected by quantity? Suppose we need 50 or 100 pieces?

The 3-day promise applies to orders for five or less modules. (Two or less for 9-day items). If requested, Acopian will ship five pieces of a larger order in 3 days and, with consideration of your requirement, schedule the balance. (Since each shipment is processed and priced as a separate order, for lowest prices request shipment in one lot.)

What if I need four or five different models? Does the 3-day promise still apply?

Yes. Guaranteed 3-day shipment applies to one model or to a combination of models.

Do I have to ask for 3-day shipment of my order?

3-day shipment is automatic. In fact, you must tell us if you want the shipment delayed.

How long after you ship will I have the power supplies?

Transportation time varies with the carrier used. Unless otherwise requested, Acopian ships small orders by UPS Ground.

You say Acopian has never failed to meet the 3-day promise. How do you do it?

Our facilities have been designed and equipped to meet our 3-day shipment promise. When your order is received, your power supplies are built specifically for you and shipped within three days. We do not ship from stock. (For this reason, we are unable to accept returns for credit.)

I've seen other power supply manufacturers advertise "same-day shipment." Isn't that better than 3-day shipment?

A typical vendor's "same-day shipment" advertisement can only be fulfilled if the power supplies you need are in stock. Otherwise, a four to six week delay is not unusual before inventory is replenished and your order is shipped.

Acopian's 3-day shipment promise applies to ALL 3 Day models (larger units ship within 9 Days) and is not dependent on the quantity in stock. We build each unit after the order for that unit is received. If an order is needed faster, often times we can ship in less than 3 days.

If you require shipment even earlier than our standard promise, just let us know, we can usually ship sooner. We welcome the opportunity to work with you.

ACOPIAN...

...answers your phone call with a live salesperson

No automated menus. The person who answers your call will courteously and promptly answer your questions, quote price and delivery, expedite your urgent requirements, and offer you immediate access to our engineers.

Call toll free 800-523-9478.

...can customize power supplies for you

If a standard power supply does not meet all of your requirements, speak with one of our engineers. We can often modify the specifications, ratings and configuration of a supply. We can also combine several power supplies into a Multiple Output Power System with the operating features you specify (such as meters and switches) and ship it within 9 Days!

...has a 5-year warranty

This is typical: One of our customers sent us an old power supply with a note indicating that the supply had been in continuous use since 1972 (33 years!), but he had recently noticed that the output voltage was low. We found that the capacitors had dried up, replaced them and returned the supply to the customer, who thanked us and said he intends to keep using it. We focus on making power supplies that will last a long time. There are power supplies that cost less than ours, or that are smaller than ours, but you won't find any that last longer than ours. All too often, low-priced supplies are densely packed, run hot, have short lifetimes and short warranties. All Acopian metal-cased power products have a 5-year warranty, but you can expect them to last a lot longer.

Purchase Acopian... 3-day shipment, long lasting power supplies, and unsurpassed customer service.

"In my business, Acopian is referred to as bulletproof. It never fails and lasts forever."

- Steve Andrews, President
Technical Options, Inc.

"If Acopian made automobiles, I'd buy one without question."

- David A. Price, Research Technologist
Georgia Tech Research Institute

ORDERING INFORMATION & Terms and Conditions

ACOPIAN SELLS FACTORY DIRECT WORLDWIDE: We do not use representatives or distributors. Contact Acopian for technical information or a quote.

WARRANTY: Acopian power supplies are warranted to be free from defects in material and workmanship for a period of five years (encapsulated devices, for one year) from date of original shipment. Acopian's obligation under this warranty is limited to repairing any power supply returned to the factory Service Department in Easton, PA and replacing any defective parts. Mini Encapsulated power supplies are not repairable. Authorization must be obtained from Acopian before a power supply may be returned for repair. Units must be well packed when shipping to Acopian; the repair of any damage incurred during shipment will be charged. Transportation charges are to be paid by the purchaser. A reinspection and handling charge will be applied to returned units found to have no defects. If a failure has been caused by misuse, operation in excess of specifications, or modification by the customer, repairs will be billed at cost; in such cases, a cost estimate will be submitted before work is started.

Acopian reserves the right to make changes or improvements in its products without incurring any obligation to install the same on products previously manufactured.

This warranty is in lieu of all other warranties, obligations, and liabilities, expressed or implied, and is the purchaser's exclusive remedy. Acopian makes no warranty, either express or implied, of merchantability, fitness for a particular purpose or otherwise. In no event shall Acopian be liable whether in contract, tort, or negligence, for special, indirect, incidental or consequential damages of any kind, including loss of business or profits, or any other losses incurred by the purchaser or any third party, the Customer's remedies being limited, at Acopian's option, to replacement, repair or credit at the price on the date of claim.

The validity, performance and construction of all terms and conditions and any sale made by Acopian shall be determined by the law of Pennsylvania, without regard to its conflict of law principles, and all parties to the transaction expressly consent to the jurisdiction of such courts and consent to the venue of the Court of Common Pleas for Northampton County, Pennsylvania.

PRICES: The prices shown are F.O.B. our factory; Easton, PA. or Melbourne, FL.. All prices and specifications are subject to change without notice. Minimum order is \$50.00.

TERMS: Net 30 days, subject to credit approval. Visa, MasterCard and American Express also accepted.

SHIPPING: Location permitting, small shipments are made by United Parcel Service, or by Parcel Post; larger shipments, by insured motor freight collect. Shipments can be made by air upon request. Risk of loss shall be F.O.B. Our Factory, even in cases where freight may be prepaid or allowed to destination by Acopian. If equipment is received in damaged condition, it is the customer's responsibility to contact the carrier and file a claim for damages.

TIME FOR DELIVERY: The time for delivery quoted by Acopian is the time required to ship from our plants. We will not be liable for delays in delivery caused by any reason beyond our control, including but not limited to acts of God, casualty, civil disturbance, labor disputes, transportation or supply difficulties, or any interruption of our facilities, and the quoted time for delivery shall be extended during the continuance of such conditions and for a reasonable time thereafter. In no event will Acopian be liable for any premium transportation, procurement, or similar costs incurred by the Customer as a result of conditions beyond Acopian's control resulting in Acopian's inability to deliver product in accordance with customer's requested delivery schedules.

QUANTITY DISCOUNTS: Discounts are available to quantity buyers and are dependent upon the order quantity and the manufacturing scheduling anticipated by the order, and apply only to the quantity and delivery ordered. Partial shipments are considered as separate orders for discounting purposes.

EXPORT ORDERS: A minimum export documentation charge of \$60.00 applies. (A minimum charge of \$25.00 applies on orders requiring customs forms for Canadian orders and for orders to certain U.S. territories.)

MOISTURE/FUNGUS PROOFING: Power supplies can be furnished with a moisture and fungus resistant varnish applied to interior surfaces. To order, add the suffix letter F to the model number. The additional cost is \$25.00 per output and requires two additional days. Not available on High Voltage, Mini Encapsulated, Rack Mounting, and Gold Box Switching models.

TAGGING: Maximum of 15 characters/spaces. Add \$10.00 to price.

TEST DATA: Cost, \$35.00 or 2% of order, whichever is greater.

SPECIAL MODELS/MODIFICATIONS: Cataloged models can be altered at the factory to meet special requirements. Contact the Applications Engineering Department to discuss your needs.

PARTS: The designs used in Acopian power supplies utilize standard components to the greatest practical extent. When replacements are required, the types originally used, or their equivalents, can usually be obtained most quickly from a local electronic components distributor.

Special components, such as transformers, are stocked at the factory warehouses. Contact the Applications Engineering Department for information on the parts required, referencing the model number of the power supply, the circuit designation of the component, and a description.

PURCHASE ORDER ACCEPTANCE: Orders are accepted subject to Acopian's Terms and Conditions. Any Terms and Conditions of any Purchaser's order, agreement, or understanding which are in addition to or inconsistent with Acopian's shall not be binding upon Acopian unless made in writing and accepted over the signature of an authorized officer of Acopian. Orders shall not be considered accepted until entered into production at our plant. Acopian reserves the right to refuse any order. All typographical and clerical errors are subject to correction by Acopian.

RETURNED GOODS: Acopian products are built on a per-order basis, and ordinarily no credit can be extended for their return. No goods will be accepted for return unless authorized in writing by Acopian.

CHANGES: The customer may, by a written notice, request changes within the general scope of the order, in the drawings, designs or specifications; method of shipment; and place of delivery. If any such change causes an increase or decrease in the cost, or the time required for the processing of any part of the order, an equitable adjustment shall be made in the price or delivery schedule, or both, and the order shall be modified in writing accordingly.

CANCELLATION: Suspension or cancellation of orders may be made only upon our written approval and on terms that will indemnify us against all loss.

OVERTIME: It is anticipated that any order will be processed during regular working hours on regular working days. If for any reason the Purchaser requests Acopian to process the order, or any portion of it, outside of such regular working hours, any overtime or other additional expense occasioned thereby shall be billed to and paid by the Purchaser as an extra cost. Acopian reserves the right to decline to process the order outside regular working hours.

CUSTOMER DELAY OF WORK: If the performance of all or any part of the work is delayed or interrupted by Customer's failure to act within the time specified (or within a reasonable time if no time is specified) and such act is not expressed or implied by the order, an adjustment shall be made in the cost of performance of the order caused by such delay or interruption and the order modified in writing accordingly. Adjustment will also be made in the delivery or performance dates and any other contractual provisions affected by such delay or interruption.

GOVERNMENT SPECIFICATIONS: Pricing is based upon industrial-grade construction, marking, packing, and packaging. Exception is taken to any MIL specifications, and to any requirements for the use of special forms, documentation other than quoted, and Government Source Inspection. Acopian must decline to quote on any other basis.

APPLICATIONS ASSISTANCE: *Questions regarding the specifications, features, and use of any Acopian product should be directed to the Applications Engineering Department. A staff of power supply specialists will be pleased to assist you.*

www.acopian.com - Online Ordering and Instant Quotes Online!



Since 1957

Acopian Technical Company
P.O. Box 638, Easton, PA 18044 • Phone: (610) 258-5441 • FAX: (610) 258-2842
Call toll free: (800) 523-9478 (International: Country Code 01)

ALL ACOPIAN
POWER SUPPLIES
MADE IN U.S.A.



PHOTO COURTESY OF THE ICECUBE PROJECT

“At Project IceCube, it’s absolutely critical to have a good power supply. The ice must be as pure and clear as possible. If the power to the ice top sensor system were to fail, we would risk the tank water freezing without being controlled, resulting in bubbles and impurities, and very much reducing the quality of ice and quality of information that we can see with our detectors. We chose Acopian power supplies to power our pumping and degassing systems because of their reputation for reliability. The people at Acopian met all of our highly demanding specifications and, despite very little time until our window to ship to the Pole, they met our schedule. We were 100% satisfied.”

Jim Baccus
Cable System Manager
Project IceCube

(the international high-energy neutrino observatory being built and installed in the ice below South Pole Station)

The world’s most demanding environments demand Acopian power systems.

Design your own Acopian power system online with the System Builder at www.acopian.com. Simply enter your requirements, and you’ll receive a quotation for fully wired multiple-output power systems, without the need for you to prepare mechanical layouts or search through a power supply catalog.

Each system will be completely wired, tested and shipped within 9 days after receipt of the order. Choose Acopian – the power supplies of choice for the world’s leading engineers.



ALL ACOPIAN POWER SUPPLIES
MADE IN U.S.A.

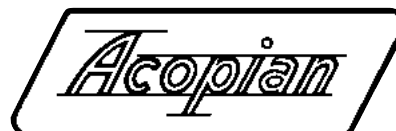

Acopian Technical Company

1-800-523-9478 • www.acopian.com